

UNDERSTANDING THE GOSPEL OF THE RIGHTEOUSNESS OF GOD IN ROMANS

**INSTEAD OF BOASTING ABOUT PRIDEFUL DISTINCTIONS,
ALL BELIEVERS (JEW AND GENTILE) NEED TO UNITE IN
PROMOTING THE WORLDWIDE MESSAGE OF THE GOSPEL
WHICH REVEALS THE RIGHTEOUSNESS OF GOD**

By Paul G. Apple,

- Original Outlines 1993 with Dan Broadwater
- Revised Commentary February, 2023

“For I am not ashamed of the gospel, for it is the power of God for salvation to everyone who believes, to the Jew first and also to the Greek. For in it the righteousness of God is revealed from faith to faith; as it is written, ‘But the righteous man shall live by faith.’” 1:16-17

This data file is the sole property of the author Paul Apple. However, permission is granted for others to use and distribute these materials for the edification of others under two simple conditions:

- 1) The contents must be faithfully represented including credit to the author where appropriate.
- 2) The material must be distributed freely without any financial remuneration.

This data file may not be copied for resale or incorporated in any commercial publications, recordings, broadcasts, performances, displays or other products offered for sale, without the written permission of Paul Apple. Requests for permission should be made in writing and addressed to:

Paul Apple, 304 N. Beechwood Ave., Baltimore MD 21228.

www.bibleoutlines.com

paulgapple@gmail.com

BACKGROUND NOTES

GENERAL:

J. Sidlow Baxter: [quoting **Findlay**] This is St. Paul's *magnum opus*. Here we see him at his greatest as a constructive thinker and theologian. The Epistle to the Romans is the complete and mature expression of the apostle's main doctrines, which it unfolds in due order and proportion and combines into an organic whole. For the purposes of systematic theology it is the most important book in the Bible. More than any other, it has determined the course of Christian thought.

Bob Deffinbaugh: It is hardly possible to stress too vigorously the importance of the Book of Romans. **Coleridge** referred to Romans as, "The profoundest piece of writing in existence." **Luther** said it was, "The chief book of the New Testament. ... It deserves to be known by heart, word for word, by every Christian." According to **C. A. Fox**, "**Chrysostom** used to have it read over to him twice every week by his own express order. ... Unquestionably the fullest, deepest compendium of all sacred foundation truths."

Michael Bird: Paul's epistle to the Romans stands arguably as the apex of Pauline thought. It is the longest letter in the Pauline corpus. In addition, it is his most theologically erudite and pastorally applicable set of teachings about faith in Jesus Christ. It is a letter that has had a monumental impact in the history of Christian thought.

Ray Stedman: If you had no other book of the Bible than this, you would find every Christian teaching at least mentioned here. That is why I call this book **The Master Key** to Scripture. If you really grasp the book of Romans in its totality, you will find yourself at home in any other part of the Scriptures.

R. Kent Hughes: There is no doubt about the power of the book of Romans. The study of it produces genuine excitement and genuine trepidation—excitement because of the possibilities the life-changing themes of Romans bring to us, and trepidation at reasonably expounding their massiveness.

Thomas Schreiner: The magisterial character of Romans is apparent to any careful reader, and its importance is magnified when one reflects on the history of exegesis. Even though **Augustine** never wrote a full-length commentary on Romans, his theology—which has probably exerted more influence on the church worldwide than that of any other theologian in the history of the church—was deeply indebted to Romans. The impact of Romans on **Martin Luther's** theology is well known. He formulated his understanding of sin, law and gospel, faith, salvation, and the righteousness of God by conducting an intensive exegesis of this letter. In his preface to the epistle he says, "This epistle is really the chief part of the New Testament, and is truly the purest gospel. It is worthy not only that every Christian should know it word for word, by heart, but also that he should occupy himself with it every day, as the daily bread of the soul" (**Luther** 1972: 365). Luther's understanding of Romans and Pauline theology constituted the most

significant shift in exegesis and theology since Augustine. Indeed, Luther's pastoral and theological wrestling with the letter continues to influence us to this very day.

One should not reflect on the significance of the letter without mentioning **John Calvin**. Calvin's exegesis of the letter is characterized by the "lucid brevity" (1960: 1) that he considers the chief virtue of the interpreter. Thereby the meaning of the author is not muffled by the verbosity of the commentator. The seriousness with which he applied himself is evident. "It is, therefore, presumptuous and almost blasphemous to turn the meaning of Scripture around without due care, as though it were some game that we were playing" (1960: 4). He identifies the theme of Romans as follows: "Man's only righteousness is the mercy of God in Christ, when it is offered by the Gospel and received by faith" (1960: 5). He also remarks that "if we have gained a true understanding of this Epistle, we have an open door to all the most profound treasures of Scripture" (1960: 5). Calvin admirably succeeded in his desire to write a commentary marked by clarity and brevity, and scholars still read his commentary today as a model of theological and historical exegesis.

Martin Luther: Then I grasped that the **righteousness of God** is that righteousness by which through grace and sheer mercy God justifies us by faith. Thereupon I felt myself to be reborn and to have gone through open doors into paradise ... I broke through. And as I had formerly hated the expression '*the righteousness of God*,' I now began to regard it as my dearest and most comforting word.

John Stott: It was Paul's devastating exposure of universal human sin and guilt in **Romans 1:18 – 3:20** which rescued me from that kind of superficial evangelism which is preoccupied only with people's 'felt needs.'"

Michael Gorman: Whatever its historical origins and specific contexts, Romans is truly a **letter for all seasons**. If John is the gospel of life, Romans is the **epistle of life**. It proclaims to us the gift of new life, narrating the saving grace of God toward sinful humanity, both Jews and gentiles. This grace creates, in Christ, a multicultural, cruciform (cross-shaped) community of obedient faith issuing in generous love and expectant hope. And that is just about the highest calling any letter by any Christian author can fulfill.

AUTHORSHIP, BACKGROUND, SETTING

Chuck Swindoll: The apostle Paul wrote to the Romans from the Greek city of Corinth in AD 57, just three years after the 16-year-old Nero had ascended to the throne as Emperor of Rome. The political situation in the capital had not yet deteriorated for the Roman Christians, as Nero wouldn't begin his persecution of them until he made them scapegoats after the great Roman fire in AD 64. Therefore, Paul wrote to a church that was experiencing a time of relative peace, but a church that he felt needed a strong dose of basic gospel doctrine.

John Harvey: Romans has been accepted as Pauline since post-apostolic times (1 Clem 32.2; 35.5; 50.6; Polycarp 3.3; 4.1; 6.2; 10.1; Ignatius, Eph. 19.3; Magn. 6.2; 9.1; Trall. 9.2; Smyr. 1.1). That conclusion is seldom disputed, and the internal evidence supports it:

1. The salutation identifies Paul as the author (**1:1**).
2. The author's background fits that of Paul (**11:1**; cf. **2 Cor 11:22**; **Phil 3:5**).
3. The author's companions, travels, and ministry all fit the record of Paul's activities in Acts (**15:14–33**; **16:21–23**).
4. The language and style are similar to other letters ascribed to Paul.
5. The content of the letter reflects others ascribed to Paul.

Internal statements suggest that the letter was written close to the end of Paul's third missionary journey, most likely from Corinth.

1. Acts places Paul in Achaia for three months before he traveled to Jerusalem (**Acts 20:1–3**).
2. Gaius, whose household Paul baptized in Corinth (**1 Cor 1:14**), was Paul's host (**16:23**).
3. The collection had been completed (**15:25–29**), and Paul was ready to leave for Jerusalem (**15:25**).
4. Timothy and Sopater, who accompanied Paul when he left Greece for Jerusalem (**Acts 20:4**), were present with Paul when he wrote (**16:23**).

John MacArthur: Paul wrote Romans from Corinth, as the references to Phoebe (**Rom. 16:1**, Cenchrea was Corinth's port), Gaius (**Rom. 16:23**), and Erastus (**Rom. 16:23**)—all of whom were associated with Corinth—indicate. The apostle wrote the letter toward the close of his third missionary journey (most likely in A.D. 56), as he prepared to leave for Palestine with an offering for the poor believers in the Jerusalem church (**Rom. 15:25**). Phoebe was given the great responsibility of delivering this letter to the Roman believers (**16:1, 2**).

Rome was the capital and most important city of the Roman Empire. It was founded in 753 B.C., but is not mentioned in Scripture until NT times. Rome is located along the banks of the Tiber River, about 15 miles from the Mediterranean Sea. Until an artificial harbor was built at nearby Ostia, Rome's main harbor was Puteoli, some 150 miles away. In Paul's day, the city had a population of over one million people, many of whom were slaves. Rome boasted magnificent buildings, such as the Emperor's palace, the Circus Maximus, and the Forum, but its beauty was marred by the slums in which so many lived. According to tradition, Paul was martyred outside Rome on the Ostian Way during Nero's reign (A.D. 54–68).

Some of those converted on the Day of Pentecost probably founded the church at Rome (cf. **Acts 2:10**). Paul had long sought to visit the Roman church, but had been prevented from doing so (**1:13**). In God's providence, Paul's inability to visit Rome gave the world this inspired masterpiece of gospel doctrine.

Grant Osborne: The founders of the church at Rome are unknown. It was not started by Peter—his ministry was to Jews, and he seems to have settled in Rome just after Paul’s arrival in about A.D. 60. And the church was not founded by Paul—he admits to not having been there (**Romans 1:11-13; 15:23-24**). Most likely, the church was begun by Jews who had been in Jerusalem for the Passover celebration and had been converted through Peter’s powerful sermon and the outpouring of the Holy Spirit in A.D. 30 (**Acts 2:5-40**). These new believers were soon joined by travelers like Aquila and Priscilla who had heard the Good News in other places and had brought it back to Rome.

Douglas Moo: It is clear that Paul writes Romans while in Corinth during the third missionary journey (**Acts 20:2-3**). This is probably in A.D. 57, give or take a year. What is most significant for our understanding of Romans is the sense Paul gives us of having reached an important transition point in his missionary career. He has been preaching the gospel for almost twenty-five years; he has planted thriving churches over much of the northeastern Mediterranean part of the Roman Empire; he has hammered out his theology on the anvil of pastoral problems and debates with opposing factions. He thus writes Romans during a lull in his ministry, at a time when he can reflect on what he has come to believe and what it may mean for the church. . .

The Jewish character of Christianity in Rome suddenly and drastically changed. In A.D. 49 Emperor Claudius, out of exasperation with squabbles among the Jews about Chrestus (probably a reference to Jesus’ claims to be the “Christ”), issued an edict that required all Jews to leave Rome.³ Jewish-Christians (like Priscilla and Aquila; cf. **Acts 18:2**) would have been included. Overnight, therefore, the church in Rome became virtually 100 percent Gentile.

By the time Paul writes, Jews were allowed back into Rome (see, again, Priscilla and Aquila, **Rom. 16:3**). But they came back to a **church dominated by Gentiles**. One can imagine the kind of **social tension** that such a situation would create. Jews, who stand in the heritage from which Christianity has sprung and who were at one time the leaders of the community, now find themselves in a minority. Several key emphases of the letter make good sense against this background: the preoccupation with the Jewish law and its place in the life of Christians (e.g., **Rom. 7**), Paul’s scolding of the Gentile Christians for their arrogance (**11:18-23, 25**; cf. 13-14), and, most of all, his admonitions to the strong and the weak (**14:1-15:13**).

Frank Thielman: Claudius “*commanded all the Jews to leave Rome*” (**Acts 18:2**), but it is unlikely that he rigorously enforced his command. To expel every Jew from Rome would have involved displacing tens of thousands of people and would have surely made a greater ripple in the historical record had it been strictly enforced. Tacitus never mentions the expulsion, and despite the claim of Orosius that Josephus gives its date (*Historia adversus Paganos* 7.6) no extant text of Josephus contains any reference to it. Dio Cassius refers only to Claudius’s prohibition of Jewish meetings in AD 41 and adds that an expulsion would have created too much disorder because of the vast numbers of Jews in the city (*Roman History* 60.6.6).

The evidence suggests that Claudius issued both the edict in AD 41 and the edict in AD 49 from a need to appear to the public as Rome's strong bulwark against foreign influences. He seems to have had little will to enforce the edict of AD 49 consistently once it had served its rhetorical purpose. Some Jewish Christians, such as Aquila and Priscilla, left the city as a result of the edict, but **it is not at all clear that the ethnic composition of the Christian community in Rome significantly changed as a result of the number of Jews who left.**

It seems more likely that the Roman church was mainly gentile when Paul wrote to it because the numbers of gentile Christians in Rome had simply increased over time. It is probable that many of these gentiles were first attracted to Judaism, like so many other gentiles in Rome in the first century. The gospel, grounded as it was in Judaism but with its focus on reaching out to all nations, would have been intelligible and attractive to such gentiles, and it seems logical to expect that their numbers would increase (cf., e.g., **Acts 8:26–39; 10:1–48; 16:14–15; 17:4, 12**). The tensions evident in **14:1–15:7**, moreover, certainly had an ethnic component (cf. **15:8–9**), but the distinction between the weak and the strong may well not have followed strictly ethnic boundaries. Just as there were many non-Jews in Rome in the mid-first century who followed some Jewish customs, there were undoubtedly more Jewish Christians in Rome than just Prisca and Aquila (**16:3–4**) who, like Paul, believed they were free from the constraints of the Jewish law (cf. **1 Cor 9:19–23**). What probably joined them all together right across their ethnic differences and their differences about the Mosaic law's interpretation was **their knowledge of the Mosaic law** and of the Scriptures generally. *"I am speaking to those who know the law,"* Paul says in **Romans 7:1**.

Michael Bird: The situation in Rome, as far as we can reconstruct it, seems to assume that some kind of friction between Gentile Christians and Jewish Christians has developed. The issues could have been manifold and included in-house debates over Torah, leadership tensions caused by the expulsion and return of Jewish Christians to Rome, and divisions fostered by ethnic prejudices. Paul shows genuine concern that the Roman house churches might splinter along ethnic or theological lines. In light of that, Paul wants to work for the unity of the Roman churches by binding them together around the gospel and his vision of the church as the multi-ethnic people of God. That way Paul can return to Jerusalem with a unified Roman church behind him, and a unified Roman church is more likely to be able to support his future missionary work in Spain.

PURPOSE OF WRITING

John MacArthur:

Paul's primary purpose in writing Romans was to teach the great truths of the gospel of grace to believers who had never received apostolic instruction. The letter also introduced him to a church where he was personally unknown, but hoped to visit soon for several important reasons: to edify the believers (**1:11**); to preach the gospel (**1:15**); and to get to

know the Roman Christians, so they could encourage him (1:12; 15:32), better pray for him (15:30), and help him with his planned ministry in Spain (15:28).

Daniel Wallace: Purpose in Writing

Paul's occasion-purpose for writing Romans is threefold:

- (1) he was going west and needed to have a base of operations in a church that shared both his vision and his theology;
- (2) he knew that his life was in danger and wanted to give something of a more balanced, systematic presentation of his gospel, to leave as a memorial; and
- (3) he detected anti-Semitism arising in the Roman church through the influence of Claudius' edict and wanted to give a theologically-based correction to this attitude.

J. Sidlow Baxter: Need to answer many key questions –

It was inevitable that the wide-spreading new faith should evoke momentous questions.

- What about the doctrine of God's righteousness if, as this new preaching says, sinners everywhere may be freely pardoned through grace?
- What about the relation of this "Gospel" to the Law of Moses? Does it not repudiate Moses?
- And what about the Abrahamic covenant? How can the admission of Gentiles to equal privilege with the Jews be reconciled with that?
- And what is going to become of morals if God is now going to deal with men on the ground of grace instead of holding them accountable to a righteous law? Will not people sin more than ever, that grace may abound?
- And what about Israel's special covenant-relation with God? Does not the new "Gospel" imply that God has now cast off His people?

To many a pious Jew it would seem as though the new doctrine was flinging to the winds those heritages which were dearest and most vital. So, too, many a new Christian convert, whether Jew or Gentile would be perplexed by such questions.

Douglas Moo: Romans is theological through and through—but it is **occasional**, not **systematic** theology. The first-century situation of the church at large and the church in Rome in particular leads Paul to develop his theology on certain particular issues. But in God's providence, those situations are such that Paul ends up addressing issues of perennial theological significance. . . We conclude that Paul's audience in Romans includes both Gentile and Jewish Christians, with Gentile Christians in the majority. . .

Paul's purpose in Romans, therefore, cannot be restricted to any one of these suggestions. He has several "reasons for Romans." But the various purposes share a common denominator: Paul's missionary situation. The past battles to define and defend the gospel, the coming crisis in Jerusalem, the need to secure a logistical base for his outreach in Spain, the importance of unifying the Roman Christians around a common vision of the gospel—all these specific purposes conspire to lead Paul to rehearse his understanding of the gospel.

Grant Osborne: Message: Sin, Salvation, Spiritual growth, Sovereignty, and Service.

Because Paul was introducing himself to the Romans, he carefully outlined his beliefs. And because Paul was writing to help strengthen the faith of these young Christians, he was careful to build his case slowly, starting with the basics. The result was a concise, logical, and well-ordered presentation of Christian theology. In short, Paul's message was **Rom. 1:16-17**.

Paul wrote to introduce himself to the Romans and to strengthen the faith of these young Christians. The result is a concise, logical, and well-ordered presentation of Christian theology.

Before announcing the good news, Paul gives the **bad news**: the whole human race stands condemned as sinners, deserving God's wrath and punishment. But that bad news sets the stage for the Good News. So Paul joyfully explains the rest of the story—that salvation is available from God through faith (not by works) in Christ, and Christ alone. Our sin highlights our need to be forgiven. God, in his kindness, provides the way for us to be saved.

Next Paul turns his attention to the practical implications of being saved. First, of course, there is the matter of growth in the faith. Believing in Christ (being "saved") is only the beginning. New followers of Christ must mature in their relationship with God, continually turning away from sin and obeying God. Through the power of the Spirit, believers are freed from the cycle of sin and death and are sanctified—made holy—set apart from sin and enabled to obey and to become more like Christ.

Paul then tells of God's sovereignty. Although the world is not the way it should be, God is working all things for good. God's plan has worked in the past, through the Jews; now it includes everyone who calls on the Lord's name—both Jews and Gentiles. God is in control of the present and the future too. Overwhelmed by the awesome power and plan of God, Paul breaks into song.

Finally, Paul turns to service, serving God and the other members of the body of Christ, the church. Paul explains how believers should relate to society, to government, and to neighbors. He also tells how they should relate to their brothers and sisters in Christ—encouraging Christians to use their spiritual gifts and to help weaker members. Then Paul concludes with personal greetings and final exhortations.

Frank Thielman: He also hoped that his visit to them, when it finally happened, would be an occasion for the Roman Christians to encourage him (**1:12**). Paul had two specific forms of encouragement in mind.

- First, he wanted the Roman Christians' heartfelt support for his extension of the gospel westward to Spain (**15:24**). When Paul said he wanted "*to be sent on*" (προπεμφθῆναι) to Spain by the Romans, he used a term that probably means he hoped they would outfit him with "companions, food, money, and perhaps a means for travel by sea."

- Second, he wanted the Roman Christians' prayers for the success of his relief project for the poor among the Christians of Jerusalem (**15:30**), a project that demonstrated the tight spiritual bond between Jewish and gentile Christians and reminded gentile Christians that the foundation of their faith lay in Israel's ancient biblical traditions (**15:27**).

Paul's commission to take the gospel to the gentiles and his conviction that Israel's traditions remained important for gentile Christians, then, were at the forefront of his thinking when he wrote Romans. His commission as apostle to the gentiles led him to believe that he should offer pastoral counsel based on the gospel to the Roman Christians and led him to hope that they would support the next major phase of his ministry as he moved westward to Spain.

Thomas Schreiner: Paul's intention was to demonstrate that his gospel constitutes the true fulfillment of what the OT Scriptures teach about the Mosaic law, circumcision, and the role of Israel (and gentiles) in salvation history. Paul's particular advice to the strong and the weak in **Rom. 14–15** would never be accepted if fundamental disagreement existed over his conception of the role of Jews and gentiles in God's plan. Thus one of Paul's primary aims was to **unify the church in Rome through his gospel** so that Jews and gentiles together would worship God in harmony, understanding that their unified worship fulfilled what the OT Scriptures taught (cf. **15:7–13**). . .

Unity was not the only reason why Paul wrote Romans. He hoped that the unified congregations would rally together to **support his mission to Spain** (15:22–24). Paul presumably wanted Rome to be his supporting base for his mission to the west. Rome could scarcely be a sending base if the churches were torn apart by strife. Nor would they wholeheartedly champion Paul's mission if they were uncertain about or disagreed with his theology. **A. Hultgren** (2011: 19) rightly says that Romans isn't a doctrinal treatise. But "it can nevertheless be considered a summation and projection of Paul's primary theological convictions delivered to a community that knew him only in part but whose support he so ardently sought for his mission to Spain." Thus, just as Paul had to set forth his teaching to resolve the disputes between Jews and gentiles, so too his teaching had to be embraced for them to support his mission. . .

Unity is to be pursued so that the church worships God together in harmony. A harmonious church would bring honor and praise to God's name. . . Paul ultimately wrote Romans as a servant of God to honor his Lord. In my exegesis of the letter, I have endeavored to show inductively that God's glory is indeed ultimate, and the credibility of my hypothesis stands or falls with my exegesis of the letter.

James Denney: It is an **epistle**, not a book. Paul wrote to Rome, not simply to clear up his own mind, not as a modern writer might do, addressing the world at large; he wrote to this particular community, and under a particular impulse. He knew something about the Church, as **chaps. xiv.** and **xv.** show; and while he might have acquired such information from members of it whom he met in Corinth, Ephesus, or elsewhere, it is quite probable, from **chap. xvi.**, that he had friends and correspondents at Rome itself. He wrote to the

Roman Christians because it was in his mind to visit them; but the nature of his letter is determined, not simply by consideration of their necessities, but by consideration of his own position. The letter is “**occasional**,” in the sense that it had a historical motive—to intimate and prepare for the coming visit; but it is not occasional in the sense in which the first Epistle to the Corinthians is so. It is not a series of answers to questions which the Romans had propounded; it is not a discussion, relevant to them only, of points either in doctrine or practice which had incidentally come to be of critical importance in Rome. Its character, in relation to St. Paul’s mind, is far more central and absolute than this would imply. It is in a real sense a **systematic exposition** of what he distinctively calls “*my gospel*” (**ii. 16**), such an exposition as makes him thoroughly known to a community which he foresaw would have a decisive importance in the history of Christianity. It is not an impromptu note, nor a series of unconnected remarks, each with a motive of its own; it is the **manifesto of his gospel**, by means of which the Apostle of the Gentiles, at a great crisis and turning point in his life, establishes relations with the Christian community in the capital of the Gentile world. It can be dated, of course, but no writing in the New Testament is less casual; none more catholic and eternal. It is quite true that in expounding his gospel Paul proceeds by a certain dialectical process; he advances step by step, and at every step defines the Christian truth as against some false or defective, some anti-Christian or infra-Christian view; in this sense it is controversial. But we have seen already the limitations under which alone a , controversial character can be ascribed to it; Paul is not so much controverting anybody in particular as vindicating the truth he expounds against the assaults and misconstructions to which he had found it give rise. There is no animosity against the Jews in it; no sentence such as **1 Thess. ii. 15 f.** or **Gal. v. 12**. It is an establishment of principles he aims at; except in **iii. 8, xvi. 17-20** there is no reference to persons. Even in **chaps. ix.-xi.** (see the introduction at **chap. ix.**) the whole tone is **conciliatory**; the one thing which tries our faith in them is Paul’s assurance of the future of his own people. But as an interpretation of the actual working out in human history of that method of salvation which he has expounded in the first eight chapters—as an exhibition of the process through which the rejection of the Jews and the calling of the Gentiles alike contribute eventually to the universality of the Gospel—these chapters are an essential part of the epistle. They are mainly but not exclusively **apologetic**: they belong to that whole conception of the Gospel, and of the mode in which it becomes the inheritance of the world, which was of one substance with the mind of St. Paul. No one who read the first eleven chapters of the epistle could meet the Apostle as a stranger on anything essential in Christianity as he understood it. No doubt, as **Grafe** has remarked, it does not contain an eschatology like **1 Cor. xv.** or **2 Cor. v.**, nor a Christology like **Col. i.** But it establishes that which is **fundamental** beyond the possibility of misconception. It vindicates once for all the central facts, truths and experiences, without which Christianity cannot exist. It vindicates them at once in their relation to the whole past of mankind, and in their absolute newness, originality and self-sufficiency. It is an utter misapprehension to say that “just the most fundamental doctrines—the Divine Lordship of Christ, the value of His death, the nature of the ‘Sacraments—are assumed rather than stated or proved” (**Sanday** and **Headlam**, p. xli.). There can be only one fundamental doctrine, and that doctrine for Paul is the **doctrine of justification by faith**. That is not part of his gospel, it is the whole of it: there **Luther** is his true interpreter. If legalists or moralists object, Paul’s answer is that justification regenerates, and that nothing else

does. By its consistency with this fundamental doctrine, we test everything else that is put forward as Christian. It is only as we hold this, on principle, with the clearness with which Paul held it, that we can know what Christian liberty is in the sense of the New Testament— that liberty in which the will of God is done from the heart, and in which no commandments or ordinances of men, no definitions or traditions, no customs or “orders,” have any legal authority for the conscience. And in the only legitimate sense of the word this liberty does not make void, but establishes the law. That is the paradox in the true religion which perpetually baffles those who would reduce it to an institution or a code.

Michael Gorman: If there is Jewish-gentile conflict in the community, as I think there is, then the letter’s profound theology about Jew and gentile must surely have as one of its primary goals the resolution of that discord. But in addition to addressing that conflict, Paul seeks to spell out what new life in Christ—which means in Christian community— looks like on the ground. Romans demonstrates, no less than any other Pauline letter, that Paul’s theology always has a pastoral function; he has a formational, or transformational, agenda.

John Toews: The **pastoral theology** Paul formulates for this problem centers in the **equality of Jew and Gentile before God**. Both are judged equally and both are made righteous equally by God through the faithfulness of Messiah Jesus. The emphasis is on the gospel for all, both Jew and Gentile. This equality blunts the assumption of Jewish privilege and the Gentile presumption of superiority. The gospel as the power of God affirms the election of Israel in continuity with the promises of God and includes the Gentiles in the people of God in a righteous way.

Paul argues for the entry of Gentiles into God’s plan of salvation that originated in Israel. That is why he emphasizes both the equality of Jews and Gentiles and the priority of Israel. In the process he redefines Judaism. Paul outlines a gospel that opens the people of God to the Gentiles on the basis of a new way to be righteous before God. Gentile Christians are asked not to reject Israel, because God will yet keep the promises to this people.

Romans is about relationships between two people, Jews and Gentiles, in the gospel. It seeks the theological and social reorientation of both Jewish and Gentile Christians. Jewish-Christian and Gentile-Christian congregations can live together in peace with each other and with Jewish synagogues because both have been incorporated into the one people that God is creating in the world. Both people become real children of Abraham. The reconciliation of Christians and Jews and Jewish and Gentile Christians would make Paul welcome in Rome, and would provide a base of support for his mission to Spain.

Why Romans? Paul writes Romans to remind the Christians in the city that God is creating one people composed of Jews and Gentiles in the world. If that reminder is effective it will:

- 1) impart a spiritual gift to the churches;
- 2) bear fruit;

- 3) correct some false teachings about Paul and his gospel; and
- 4) prepare the churches to support his mission to the West.

Michael Bird: In brief, Romans is a word of exhortation,³⁰ a masterpiece of missional theology, culturally savvy apologetics, christological exegesis, pastoral care, theological exposition, and artful rhetoric — all designed to win over the audience to Paul's gospel, to support his mission in Spain, to draw Jewish and Gentile Christians in Rome closer together, to strengthen them in the faith despite the perils of Roman culture, and to encourage his audience to identify with the apostle to the Gentiles as he goes to Jerusalem.

MAJOR THEMES AND THEOLOGY

John Murray: The **righteousness** contemplated is God's righteousness. It is, therefore, a righteousness with divine quality and possessed of the efficacy and virtue which divinity implies. It is not the divine attribute of justice but it is nevertheless a righteousness with divine attributes and properties, contrasted not merely with human unrighteousness but with human righteousness. The grand theme of the early part of the epistle is **justification by grace through faith**. And human righteousness is the essence of the religion of this world in contradiction to the gospel of God. Only a God-righteousness can measure up to the desperateness of our need and make the gospel the power of God unto salvation.

It is this theme that is unfolded in **3:21–26**. Here it is made clear that this righteousness comes through the redemption which is in Christ Jesus and the propitiation in his blood. Justification with God is that which this righteousness secures and propitiation is God's own provision to show forth his justice that he may be just and the justifier of the ungodly. This thesis is brought to its focal expression in **5:15–21** where it is set forth as the free gift of righteousness and consists in the righteous action and obedience of Christ (**vss. 17, 18, 19**). Grace thus reigns through righteousness unto eternal life through Jesus Christ our Lord (vs. 21).

David Jeremiah:

Several key themes are prominent in Paul's letter to the Romans. The first is that **justification** (being made righteous before God) **comes by faith alone in Christ**. Paul explains that all have sinned and stand condemned for failing to live up to God's standard of righteousness (see **1:19–3:20**). Some had claimed the way to achieve this righteousness (and thus attain salvation) was by following the Old Testament law. However, while Paul agrees the law is good for teaching about God's holiness, our sin, and God's ultimate plan for redemption, he concludes the law itself is powerless to save. Only faith in Jesus can bring salvation—it cannot be earned through good works or obedience to the law (see **3:21–5:21**). Justification is therefore a gift from God that He makes available to us through the death and resurrection of His Son.

A second theme is that **God calls us to lead sanctified lives** (see **6:1–8:39**). To be sanctified means to live according to God’s design and purpose. God calls us to be holy and set apart from the world to do His work. However, even though we are no longer slaves to sin, we still have a sinful nature that resides within us. This creates a constant struggle between our desire to live godly lives and our desire to indulge our baser instincts. The Holy Spirit, who dwells within us, is our constant and powerful ally in this lifelong battle.

A third theme is that **God is sovereign and His plans never fail** (see **9:1–11:36**). Some people in Paul’s day were claiming that God’s purposes had “failed” with Israel because the nation had generally rejected Jesus as their promised Messiah. Paul counters this argument by first reminding his readers that God is sovereign and does not always share His plans with humanity. Further, he explains that God has always had a plan for Israel—and these plans have not concluded even though they have not accepted Christ. Paul calls on the Gentile believers to not be proud but to remember they have been “grafted in” to God’s greater plan for humanity.

A fourth theme is that **believers in Christ need to walk in righteousness** (see **12:1–15:13**). The apostle Paul believed that when we receive the gift of God’s salvation, it naturally produces a change within us—including a desire to turn away from our former lives of sin. The Holy Spirit comes to dwell within us and bestows gifts that will not only help us to lead a holy life but will also help us to serve and support other members in the church. Our new lives in Christ give us a new attitude on how we view those in authority, how we love our neighbors, how we work for Christ until His return, and how we accept and love others without judging them.

Michael Gorman: In addition to the previously noted theme of saving grace for Jews and gentiles, other key motifs in Romans, many drawn from Paul’s previous correspondence, include the following:

- Jesus as God’s Messiah
- the righteousness of God, a rich term that refers to God’s fidelity, integrity, impartiality, saving power, and restorative justice
- justification by faith and its corollary, obedience (cf. “*the obedience of faith*”—or believing allegiance—as bookends in **1:5** and **16:26**), for believing means pledging and practicing allegiance
- the death and resurrection of Jesus, and of believers with him, that brings about life before God
- salvation as God’s restoration of humanity’s lost glory and righteousness (Gk. *doxa* and *dikaiosynē*) by identification with and conformity to Christ (Christoformity or Christification or even deification/theosis)
- the multicultural character of God’s people and the unity of gentiles and Jews in Christ
- participation in Christ as participation in the Spirit within his body/community and as conformity to Christ and his story
- the gospel as God’s peacemaking initiative (Heb. *šālôm*, or *shalom*)
- the gospel’s challenge to Rome and its values

- justification, salvation, participation, and shalom as interrelated dimensions of life—both present and future (eternal)

STRUCTURE

J. Sidlow Baxter: Three-part structure

1. DOCTRINAL: How the Gospel saves the sinner (Chap. 1-8)
2. NATIONAL: How the Gospel relates to Israel (Chap. 9-11)
3. PRACTICAL: how the Gospel bears on conduct (Chap. 12-16)

Douglas Moo:

I. The Letter Opening (1:1–17)

- A. Prescript (1:1–7)
- B. Thanksgiving and Occasion: Paul and the Romans (1:8–15)
- C. The Theme of the Letter (1:16–17)

II. The Heart of the Gospel: Justification by Faith (1:18–4:25)

- A. The Universal Reign of Sin (1:18–3:20)
- B. Justification by Faith (3:21–4:25)

III. The Assurance Provided by the Gospel: The Hope of Salvation (5:1–8:39)

- A. The Hope of Glory (5:1–21)
- B. Freedom from Bondage to Sin (6:1–23)
- C. Freedom from Bondage to the Law (7:1–25)
- D. Assurance of Eternal Life in the Spirit (8:1–30)
- E. The Believer’s Security Celebrated (8:31–39)

IV. The Defense of the Gospel: The Problem of Israel (9:1–11:36)

- A. Introduction: The Tension Between God’s Promises and Israel’s Plight (9:1–5)
- B. Defining the Promise: God’s Sovereign Election (9:6–29)
- C. Understanding Israel’s Plight: Christ as the Climax of Salvation History (9:30–10:21)
- D. Summary: Israel, the “Elect,” and the “Hardened” (11:1–10)
- E. Defining the Promise (2): The Future of Israel (11:11–32)
- F. Conclusion: Praise to God in Light of His Awesome Plan (11:33–36)

V. The Transforming Power of the Gospel: Christian Conduct (12:1–15:13)

- A. The Heart of the Matter: Total Transformation (12:1–2)
- B. Humility and Mutual Service (12:3–8)
- C. Love and Its Manifestations (12:9–21)
- D. The Christian and Secular Rulers (13:1–7)
- E. Love and the Law (13:8–10)
- F. Living in Light of the Day (13:11–14)
- G. A Plea for Unity (14:1–15:13)

VI. The Letter Closing (15:14–16:27)

A. Paul’s Ministry and Travel Plans (15:14–33)

B. Greetings (16:1–16)

C. Closing Remarks and Doxology (16:17–27)

Chuck Swindoll:

ROMANS				
THE GOSPEL				
Introduction — Personal (1:1–17)	Saving the Sinner	Concerning Israel	Concerning Christian Conduct	
	<u>Depravity of humanity</u>	<u>Divine sovereignty and human will</u>	<u>Social</u>	
	<u>Grace of God</u>	<u>Past, present, and future of the nation</u>	<u>Civil</u>	
	<u>Justification by faith</u>		<u>Personal</u>	
	<u>Sanctification through the Spirit</u>			
	<u>Security of the saint</u>			
	<i>CHAPTERS</i> 1:18–8:39	<i>CHAPTERS</i> 9–11	<i>CHAPTERS</i> 12:1–15:13	
Emphasis	Doctrinal	National	Practical	
Response	Faith	Hope	Love	
Doctrine of God	Wrath	Righteousness	Glory	Grace
Doctrine of Humanity	Fallen	Dead	Saved	Struggling
Doctrine of Sin	Exposed	Conquered	Explained	Forgiven
Scope	Dead in sin	Dead to sin	Peace with God	Love for others
Theme	God’s righteousness is given to those who put their faith in Jesus Christ.			
Key Verses	1:16–17			
Christ in Romans	Jesus is the focus of the gospel and the means of salvation by God’s grace apart from works (1:1–4, 16–17).			

The Book of Romans

Focus	Doctrinal				Practical
Divisions	Problems of Unrighteousness 1 3	Provision of Righteousness 4 5	Pursuit of Righteousness 6 8	Program of Righteousness 9 11	Practice of Righteousness 12 16
Topics	Sin	Salvation	Sanctification	Selection	Service
	Understanding the Gospel				Living the Gospel
Place	Probably Corinth				
Time	About A.D. 57				
Author	The Apostle Paul				

Webtruth:

An Outline of the Epistle of Paul to the Romans				
Ch 1:1 – 3:20	Ch 3:21 – 5:19	Ch 6:1 – 8:39	Ch 9:1 – 11:36	Ch 12:1-16:27
Righteousness required because of human guilt	Righteousness imputed by divine grace	Righteousness enabled through spiritual life	Righteousness obtained by unmerited mercy	Righteousness displayed in the Christian's daily walk
What the gospel proves: Universal condemnation	What the gospel provides: Free justification	What the gospel produces: Practical sanctification	What the gospel provokes: Israel's restoration	What the gospel promotes: Daily transformation
The need for salvation	The plan of salvation	The life of salvation	The scope of salvation	The fruit of salvation
Sin	Salvation	Sanctification	Sovereignty	Service
Before I was saved	When I was saved	After I was saved	All Israel shall be saved	Now that I am saved
Genesis – the fall	Exodus - redemption	Leviticus – holiness	Numbers – disobedience	Deuteronomy – love to God and one's neighbour
Legal		Ethical	Dispensational	Practical
Faith			Hope	Love

Jensen's Survey of the NT:

1:1 <i>gospel</i>															
1:18		2:1		2:17		3:9		3:21		4:1		5:1		6:1	
7:1		8:1		9:1		9:30		11:1		12:1		12:9		13:1	
14:1		15:14		16:1											
PROLOGUE		D O C T R I N A L								PRACTICAL				EPILOGUE	
Salutation		God's Holiness in Condemning Sin		God's Grace in Justifying Sinners		God's Power in Sanctifying Believers		God's Sovereignty in Saving Jew and Gentile		God's Glory the Object of Service				Personal Notes	
Personal Testimony										Consecration of Christians 12:1-2		Practical Christian Service 15:8-13			
Theme Introduced		SIN		SALVATION		SANCTIFICATION		SOVEREIGNTY		SERVICE				Benediction and Doxology	
		slave to sin		→ slave to God		→				slave serving God					
		God's righteousness IN LAW		God's righteousness IMPUTED		God's righteousness OBEYED		God's righteousness IN ELECTION		God's righteousness DISPLAYED					
		L I F E B Y F A I T H								SERVICE BY FAITH					
		The Need of Salvation		The Way of Salvation		The Life of Salvation		The Scope of Salvation		The Service of Salvation					
		Deadline of Sin		Design of Grace		power given		Demonstrations of Salvation promises fulfilled		paths pursued					

KEY WORDS:
law, righteousness,
faith, believe, sin, death,
flesh, all, in Christ, Spirit.

KEY VERSES:
1:16-17

William Tyndale: Forasmuch as this epistle is the principal and most excellent part of the New Testament, and most pure [gospel] ... and also a light and a way unto the whole scripture, I think it meet that every Christian man not only know it by rote but also exercise himself therein evermore continually as with the daily bread of the soul. No man verily can read it too oft or study it too well: for the more it is studied the easier it is, the more it is searched the more precious things are found in it, so great treasure of spiritual things lieth hid therein.

OUTLINE OF ROMANS

UNDERSTANDING THE GOSPEL OF THE RIGHTEOUSNESS OF GOD IN ROMANS

BIG IDEA:

INSTEAD OF BOASTING ABOUT PRIDEFUL DISTINCTIONS, ALL BELIEVERS (JEW AND GENTILE) NEED TO UNITE IN PROMOTING THE WORLDWIDE MESSAGE OF THE GOSPEL WHICH REVEALS THE RIGHTEOUSNESS OF GOD

“For I am not ashamed of the gospel, for it is the power of God for salvation to everyone who believes, to the Jew first and also to the Greek. For in it the righteousness of God is revealed from faith to faith; as it is written, ‘But the righteous man shall live by faith.’” 1:16-17

I. (1:1-15) INTRODUCTION -- GOD'S CALLING COMPELS ALL BELIEVERS TO JOIN HANDS IN PROMOTING THE GOSPEL WORLDWIDE

A. (:1-7) God's Call Promotes Gospel Ministry –

7 Essentials of God's Call for the Apostle Paul (and for Your Life)

1. (:1a) Owned by the Master – Sender of the Epistle
2. (:1b) Plugged into Gifted Ministry
3. (:1c-4) Dedicated to the Gospel of God
 - a. Nature of the Gospel
 - b. (:2) Promise of the Gospel
 - c. (:3-4) Focus of the Gospel = Jesus Christ
4. (:5-6) Challenged by Worldwide Vision
 - a. (:5a) Goal of Evangelizing Gentiles of All Nations
 - b. (:5b) Goal of Glorifying Christ
 - c. (:6) Goal of Discipleship to Jesus Christ
5. (:7a) Sourced in God's Love – Recipients of the Epistle
6. (:7b) Characterized by Holiness
7. (:7c) Dependent on God's Resources – Greeting of the Epistle

B. (:8-15) Fulfilling God's Calling –

Compels Us to Reach Out to Others to Produce Abundant Gospel Fruit

1. (:8) The Evidence of Gospel Fruit Evokes Thanksgiving
 - a. Priority of Thanksgiving to God
 - b. Proclamation of Faith Worldwide
2. (:9-12) The Prospect of Abundant Gospel Fruit Motivates Us to Reach Out to Others
 - a. (:9-10) Reaching out in Concerned Prayer
 - b. (:11-12) Reaching out in Personal Ministry
3. (:13-15) The Obligation of God's Calling Compels Us to Reach Out to Others
 - a. (:13) The Compulsion to Minister in Rome
 - b. (:14) The Obligation of God's Calling Extends to All Men without Partiality
 - c. (:15) The Proper Response is 100% Eagerness to Fulfill God's Calling

(:16-17) THEME VERSES: BOASTING IN GOSPEL CLOUT – THE EFFICACY OF THE GOSPEL INSPIRES BOLDNESS IN PROCLAMATION – 2 REASONS:

A. (:16) Because the Gospel Saves –

Power of God unto Salvation to Everyone Who Believes (Both Jew and Gentile)

1. Its Content = Good News (not mixed with any bad)
2. Its Extreme Power When Appropriated by Faith
3. Its Goal
4. Its Inclusiveness and Exclusiveness

B. (:17) Because the Gospel Reveals –

the Righteousness of God that is Appropriated by Faith Alone

1. The Source of the Gospel
2. The Connection between Righteousness, Life, and Faith
3. This Connection is Consistent with the OT Teaching

II. (1:18 - 3:20) THERE IS NO ROOM FOR BOASTING (ON THE PART OF JEW OR GENTILE) BECAUSE THE GOSPEL REVEALS THE RIGHTEOUSNESS OF GOD IN CONDEMNING ALL BECAUSE ALL HAVE SINNED

A. (1:18-23) No Excuses for Rejecting God's Truth –

Rejecting What We Naturally Know about God Leaves Us without Excuse and Always Brings God's Wrath

1. (:18) Suppression of Truth – God Always Responds in Wrath against Those Who Reject his Revealed Truth
 - a. Divine Wrath is Real and Revealed
 - b. Divine Wrath is Deserved
2. (:19-20) Access to Truth – God Has Clearly Revealed Himself in Nature so that Men Are without Excuse
 - a. (:19) Universal Internal Awareness of God's Truth
 - b. (:20a) Universal External Revelation of God's Truth Via Nature
 - c. (:20b) Universal Condemnation of All Men
3. (:21-23) Perversion of Truth – Fallen Men Replace God's Glorious Truth with Things that Are Far Inferior
 - a. (:21a) The Privilege of Revelation Brings Accountability
 - b. (:21b-23) The Rejection of Revelation Replaces Glorious God with Inferior Idols

B. (1:24-32) The Downward Spiral to Total Depravity and Disintegration of Society – A Society that Abandons Truth (Their Knowledge about God) Is in Danger of Being Abandoned by God to Gross Sin and Immorality

1. (:24-25) Sexual Impurity Is God's Judgment for Idolatry
 - a. (:24) How Did God Judge Them? Sexual Impurity
 - b. (:25) How Did They Abandon the Truth? Delusion and Idolatry
2. (:26-27) Homosexuality Is God's Judgment for Worshiping the Human Body
 - a. (26a-27b) How Does God Judge Such a Society? Degradation

- b. How Did They Abandon the Truth? Homosexuality
- 3. (:28-32) Unrestrained Total Depravity Is God's Judgment for Casting off the Fear of God
 - a. (:28) How Did God Judge Them? Unrestrained Total Depravity
 - b. (:29-32) How Did They Abandon the Truth? Smorgasbord of Sins

C. (2:1-16) Good Is Never Good Enough . . . Jewishness Provides No Free Pass -- Hypocritical Humanity (Religious Moralizers) Cannot Escape God's Impartial Righteous Judgment

- 1. (:1-4) No Possible Excuses or Escape from God's Righteous Judgment
 - a. (:1) No Excuses Because Your Conduct Condemns You as You Judge Others
 - b. (:2) No Excuses or Escape Because God's Judgment Is Righteous and Certain
 - c. (:3-4) No Escape Because God Requires Repentance
- 2. (:5-11) No Partiality in God's Righteous Judgment
 - a. (:5-6) Judgment Will Be Consistent with One's Conduct
 - b. (:7-10) Two Possible Destinies for God's Impartial Righteous Judgment
 - c. (:11) Judgment Will Be Without Partiality
- 3. (:12-16) No Mere Possession of the Law or Pleading of Ignorance Will Exempt One from God's Righteous Judgment
 - a. (:12-13) Universal Requirement = Obedience to God's Law
 - b. (:14-16) Universal Judgment Makes Everyone Accountable Before God

D. (2:17-29) Religion Never Saved a Soul – Jews Not Exempt from Condemnation – Exposing False Religious Security – Even the Most Religious Person (Devout Jew) Cannot Escape God's Righteous Judgment – True Spirituality Is Much More than Possessing Religious Privileges and Practicing Religious Rituals

- 1. (:17-24) True Spirituality Is Much More than Possessing Religious Privileges
 - a. (:17-20) Religious Privileges Can Produce False Security
 - b. (:21-24) Religious Privileges Mean Nothing If Your Life Doesn't Measure Up
- 2. (:25-27) True Spirituality Is Much More than Practicing Religious Rituals
 - a. (:25) Religious Rituals Have No Value Apart from Obedience
 - b. (:26-27) Obedience Transcends Religious Rituals
- 3. (:28-29) True Spirituality that Pleases God Is an Inward Reality Accomplished by the Holy Spirit
 - a. (:28) Outward Appearances Can Be Deceiving
 - b. (:29) Inward Reality Constitutes True Spirituality

E. (3:1-8) The Faithful Righteous Judge – God's Condemnation of All Men (Even the Most Religious) Does Not Contradict:

- **The Value of Spiritual Privileges** Or
- **The Consistency of God's Own Character (His Faithfulness and Justice)**
- 1. (:1-2) God's Condemnation of All Men Does Not Contradict the Value of

Spiritual Privileges

- a. (:1) Key Question – Any Value to Spiritual Privileges If They Can't Save?
- b. (:2) Positive Answer
2. (:3-8) God's Condemnation of All Men Does Not Contradict the Consistency of His Own Character
 - a. (:3-4) He Remains Faithful to His Promises to the Jews
 - b. (:5-6) He remains Just
 - c. (:7-8) Restatement and Conclusion

F. (3:9-20) Testimony of Scripture – Guilty as Charged – The Conclusion: Universal Corruption Leaves All Men without Excuse before God's Condemnation

1. (:9) Everyone (Both Jew and Gentile and Believer) Is in the Same Boat = "Under Sin" (and the Boat Is Definitely Sinking)
2. (:10-18) How Bad Is It? Description of Universal Corruption
 - a. (:10-12) Corrupt in Nature
 - b. (:13-14) Corrupt in Speech
 - c. (:15-17) Corrupt in Conduct
 - d. (:18) Fundamental Problem = No Fear of God
3. (:19-20) The Law Can Never Save – It Only Convicts Men and Leaves Them without Excuse before God's Condemnation
 - a. (:19) How is the Knowledge of the Law an Aid to Salvation?
 - b. (:20) How Is the Limitation of the Law Actually an Aid to Salvation?

III. (3:21 - 4:25) THERE IS NO ROOM FOR BOASTING BECAUSE GOD'S ONLY PLAN OF SALVATION THROUGHOUT HISTORY HAS BEEN JUSTIFICATION BY FAITH APART FROM WORKS

A. (3:21-31) The Guts of the Gospel – God Manifests his Righteousness in Paying the Price to Justify Sinners by Grace through Faith

1. (:21-26) God's Plan of Salvation Focuses on the Gift of His Righteousness
 - a. (:21) The Manifestation of the Righteousness of God
 - b. (:22) The Appropriation of the Righteousness of God
 - c. (:23) The Desperate Need for the Righteousness of God
 - d. (:24-25a) The Redemptive Aspects of the Righteousness of God
 - 1) (:24a) The Essence of Justification
 - 2) (:24b) The Essence of Redemption
 - 3) (:25a) The Essence of Propitiation
 - e. (:25b-26) The Vindication of the Righteousness of God
2. (:27-31) God's Plan of Salvation Leaves No Room for a Spirit of Pride – A Refutation of 3 Proudful Questions
 - a. (:27-28) What about Boasting in Works?
Faith Leaves No Room for Boasting in Our Own Accomplishments
 - b. (:29-30) What about Boasting in Ethnicity?

The Oneness of God Means a Universal, Common Plan of Salvation that Leaves No Room for a Spirit of Exclusivity

- c. (:31) What about the Role of the Law -- Is the Law then Worthless? The Value of the Law Leaves No Room for a Spirit of Independent Lawlessness – Instead, Justification by Faith Should Motivate Holy Living

B. (4:1-17a) OT Roots to NT Truth – Sola Fide – Justification by Faith apart from Works Has Always Been God’s Universal Plan of Salvation – The OT Example of Abraham

1. (:1-5) Justification by Faith Alone Is Rooted in the OT Example of Abraham – Only Naked Faith Leads to Righteousness Since Any Reliance on Human Achievement Makes Grace Impossible
 - a. (:1) Abraham Makes a Good Proof Case
 - b. (:2) Human Achievement Would Leave Room for Boasting
 - c. (:3) The Testimony of the OT Regarding Abraham is Clear
 - d. (:4-5) Application of Accounting Analogy from Employment: Justification is By Grace through Faith Apart from Works
2. (:6-8) Justification by Faith Alone Is Supported by the OT Testimony of David – Forgiveness of Sins Brings True Happiness Since Righteousness Is Reckoned Apart from Works
 - a. (:6) David Makes for a Good Supporting Witness
 - b. (:7-8) True Happiness Depends on Removing the Shame and Guilt of Sin
3. (:9-12) Justification Cannot Depend on Religious Rites (Circumcision) or Ethnic Identity (Jews) Since Faith Is God’s Universal Plan down through the Ages
 - a. (:9-10) Circumcision Not Essential for Justification
 - b. (:11-12) Circumcision Still Significant in the Case of Abraham
4. (:13-17a) Justification Cannot Depend on Obedience to Law Since God Operates Via Gracious Promises
 - a. (:13) Principle: God’s Gracious Promises Are Appropriated by Faith Not by Obedience to the Law
 - b. (:14) Disconnect between Obedience to Law and Faith in God’s Promise
 - c. (:15) Purpose of the Law
 - d. (:16-17) Only Faith Is Consistent with Grace and Brings Assurance of Promise

C. (4:17b-25) Real Faith: OT Example and NT Application – Receiving God’s Promised Blessing Has Always Required Real Faith – the Kind of Faith that Looks beyond Natural obstacles to Find Assurance in God’s Power and Faithfulness

1. (:17b) Real Faith Makes Sense Because of Who God Is = His Power and Faithfulness
 - a. He is the God of Resurrection Power
 - b. He is the God of Sovereign Faithfulness
2. (:18-19) Real Faith Looks beyond Natural Obstacles
 - a. (:18) God’s Promise Seemed Unattainable

- b. (:19) Natural Obstacles Seemed Insurmountable
- 3. (:20-21) Real Faith Finds Assurance in God's Power and Faithfulness
 - a. (:20a) Confident Faith Does Not Waver But Strengthens
 - b. (:20b) Confident Faith Focuses on Giving Glory to God
 - c. (:21) Confident Faith Expects God to Deliver on His Promises
- 4. (:22-25) Real Faith Will Always Receive God's Promised Blessing
 - a. (:22) Connection Between Faith and Justification
 - b. (:23-24) Connection between Abraham's Justification and Future Believers
 - c. (:25) Christ's Death and Resurrection = the Key to the Gospel

IV. (5:1 - 8:39) THERE IS NO ROOM FOR INSECURITY BECAUSE THE RESULTS OF JUSTIFICATION BY FAITH APPLY TO ALL BELIEVERS

A. (5:1-21) Confidence and Assurance for All Believers

- 1. (:1-5) Confident Christian Living in Light of Future Glory –
Justification by Faith is the Fountainhead for Confident Christian Living in Light of Future Glory – Fruits of Justification by Faith
 - a. (:1) We Have Peace with God = Reconciliation = A Healed Relationship
 - b. (:2a) We Have Access to God's Grace through Christ's Mediation
 - c. (:2b-3a) We Are Assured of Future Glory so that Our Hearts Have Been Set Free to Truly Rejoice Even in Present Suffering
 - 1) (:2b) Rejoicing in Anticipation of Our Glorious Future
 - 2) (:3a) Rejoicing in the Midst of Present Tribulations
 - d. (:3b-4) We Have a Maturing New Character that Is Being Discovered and Developed through Suffering
 - 1) (:3b) Development of Perseverance
 - 2) (:4a) Development of Proven Character
 - 3) (:4b) Development of Hope
 - e. (:5) We Have God's Loving Spirit Working within Our Hearts to Assure Us of Future Glory
- 2. (:6-11) Secure in God's Love – Confidence in Facing the Future –
The Security of Christ's Love Allows Us to Face the Future with Joyful Confidence
 - a. (:6-8) Security Based on Christ's Death for Us –
Christ Died to Show His Love for Us in the Past – While We Were Powerless and Undeserving Enemies
 - 1) (:6) Marvelous Love of Christ Unfathomable
 - 2) (:7-8) Marvelous Love of Christ Unprecedented
 - b. (:9-10) Security Based on Christ's Current Life for Us –
Christ Lives and Will Surely Show His Love for Us in the Future Now that Our Relationship with God Has Been Restored
 - 1) (:9) Deliverance from Future Wrath Assured
 - 2) (:10) Divine Favor Assured Going Forward
 - c. (:11) Security Based on Christ's Finished Work of Reconciliation –
Causes Us to Rejoice in the Present
 - 1) Blessings Based on Justification Keep Abounding

- 2) Boasting Unleashed
- 3) Basis = Our Accomplished Reconciliation
- 3. (:12-21) Triumph of Grace over Sin –
Our Solidarity with Christ Assures of God’s Gift of Righteousness and Life Even More than Our Solidarity with Adam Brought Sin and Death
 - a. (:12-14) The Adam Bomb –
Adam’s Sin Had Grave Effects Upon Us
 - 1) (:12) Sin and Death Invaded the World through Adam
 - 2) (:13-14a) Sin and Death Reigned before the Mosaic Law
 - 3) (:14b) Adam = Type of Christ in Terms of Federal Headship
 - b. (:15-17) The Gracious Gift –
Christ’s Grace Has Greater Effects upon Us – the Resulting Righteousness and Life from Our Solidarity with Christ Are Even More Certain in a Much Different Sense
 - 1) (:15) Superior Effects of the Gracious Gift
 - 2) (:16) Superior Effects of the Gracious Gift
 - 3) (:17) Summary: Superior Effects of the Gracious Gift
 - c. (:18-19) Two Destinies –
Our Unity with Adam or Christ Will Determine Our Future
 - 1) (:18) Destiny of Condemnation vs. Justification
 - 2) (:19) Destiny of Sin vs. Righteousness
 - d. (:20-21) Surpassing Grace –
The Purpose of God’s Law Is to Magnify Our Sin and His Surpassing Grace
 - 1) (:20a) The Law Increases Sin
 - 2) (:20b-21) Increased Sin Highlights Surpassing Grace

B. (6:1-23) Freedom from the Dominion of Sin to Now Serve Righteousness

- 1. (:1-11) Grace Is Not License to Sin –
Our Union with Christ Has Freed Us from the Dominion of Sin to Live a New Life
 - a. (:1-2) Principle of Grace Raises an Obvious Shocking Question
 - 1) (:1) Introduction of the Obvious Shocking Question
 - 2) (:2) Immediate Reaction to the Absurdity of the Shocking Question
 - b. (:3-4) Union with Christ in Baptism Proves that We Have Died to the Dominion of Sin in Order to Live a New Life
 - 1) (:3-4a) Reality of Baptism into Christ’s Death and Burial
 - 2) (:4b) Reality of Baptism into Christ’s Resurrection and Newness of Life
 - c. (:5-10) Union with Christ in His Death Guarantees Our New Life
 - 1) (:5-7) Because We Have Been Freed from the Dominion of Sin
 - 2) (:8-10) Because There Is No Possibility of Double Jeopardy
 - d. (:11) Application: Believe It!
 - 1) Believe You Are Dead to the Dominion of Sin
 - 2) Believe You Are Alive to God
- 2. (:12-14) Grace Motivates Godly Living – Live for God, Not for Sin –
Exhortation and Motivation to Use God’s Grace to Resist Fulfilling the Desires of Sin

and to Offer Ourselves to God in the Pursuit of Righteousness

- a. (:12-13) The Exhortation to Live for God in the Pursuit of Righteousness
 - 1) (:12-13a) Negative Commands – Resist Sin
 - 2) (:13b) Positive Commands – Pursue Righteousness
 - b. (:14) The Motivation to Live for God in the Pursuit of Righteousness
= God’s Grace as the Governing Power of Our Life
 - 1) Live Out Your Regenerated Reality of Freedom from Sin
 - 2) Live Out the Freedom and Power of the Governing
Power of Grace
3. (:15-23) Freedom from the Law Is No License to Sin –
Grace Has Transformed Us from Slaves of Sin to Slaves of Righteousness with Benefits
of Sanctification and Life
- a. (:15-18) Freed to Pursue the Master of Righteousness –
Sin Should No Longer Be an Option for the Believer Because We Are Now
Slaves of God’s Righteousness
 - 1) (:15) Absurd Question: Does Grace Encourage Sin?
 - 2) (:16) Your Allegiance Determines Your Moral Behavior and
Ultimate Destiny
 - 3) (:17-18) Transformative Change in Allegiance
 - b. (:19-23) Freed to Benefit from the Fruits of Righteousness –
Sanctification and Eternal Life
 - 1) (:19) Obey Your Master
 - 2) (:20-21) Overthrow Your Former Life of Sin
 - 3) (:22-23) Obtain Your Benefits

C. (7:1-25) Freedom from the Dominion of the Law and a New Life in Christ

1. (:1-6) Freedom from the Dominion of the Law – A New Way to Live –
We Can Serve God in a New Way through the Spirit Since We Have Died to the Claims
of the Law and Are Now Married to Christ
 - a. (:1) The Axiom = Basic Principle –
Law Has Jurisdiction throughout Life
 - b. (:2-3) The Analogy = Marriage Contract –
The Liberating Principle of Death – Death Releases Us from the Claims of
the Law
 - 1) Essence of the Marriage Contract
 - 2) End of the Marriage Contract at Death
 - 3) Essence of Adultery
 - c. (:4) The Application to Believers Regarding Our Death to the Law
and Remarriage to Christ –
We Have Died to the Law through Christ Who Has Given Us a New and
Fruitful Marriage
 - 1) Reality: Believers Have Died to the Law
 - 2) Instrumentation – How Did We Die to the Law
 - 3) Purpose = Remarriage to Christ
 - 4) Ultimate Goal
 - d. (:5-6) The Analysis –

Contrast between Life in the Flesh and Life United to Christ

- 1) (:5) Life in the Flesh – Our Old Marriage to the Law Aroused Sinful Desires that Produced Fruit Leading to Death
 - 2) (:6) Life United to Christ – Our Death to the Law Frees us to Serve God in a New Way through the Spirit
2. (:7-12) Don't Blame God – The Law Is Not Sinful –
All the Blame for Sin Falls on Our Sinful Nature, Not on God's Law Which Remains Good
- a. (:7-8) God's Law Benefits Us by Exposing and Provoking Our Sinful Nature
 - 1) (:7a) Rejection of False Inference that the Law is Sin
 - 2) (:7b) Role of the Law is to Expose Sin
 - 3) (:8) Reaction to the Law is the Activation of Sin
 - b. (:9-11) God's Law Results in Death but the Deceitfulness of Sin Is to Blame
 - 1) (:9) The Law Replaces Spiritual Complacency with the Reality of Death
 - 2) (:10-11) The Law Results in Death
 - c. (:12) Conclusion: Regardless of Human Abuse, God's Divine Law Remains Good
3. (:13-25) Wrestling with Sin – The Hope and Struggle for Christians –
The Christian Life Is a Constant Struggle with Sin Involving Contradiction, Tension and Confusion but with the Sure Hope of Complete Deliverance through Christ
- a. (:13) The Blame for Our Death Falls Not on the Law, But on the Awfulness of Our Sinful Nature – Which the Law Exposes
 - 1) Death Cannot Be Blamed on the Law
 - 2) Our Sinful Nature Deserves All the Blame
 - b. (:14-23) The Christian's Struggle Involves Tension, Confusion and Contradiction – 3 Laments
 - 1) (:14-17) Lament #1 – Wrestling with Contradiction
 - 2) (:18-20) Lament #2 – Wrestling with Tension
 - 3) (:21-23) Lament #3 – Wrestling with Confusion
 - c. (:24-25) Nevertheless, the Christian Lives with a Confident Hope for Complete Deliverance through Christ
 - 1) (:24) Cry for Deliverance
 - 2) (:25a) Thanksgiving for Ultimate Deliverance
 - 3) (:25b) Reality of Continuing Struggle

D. (8:1-39) Freedom from the Dominion of Death and the Sure Hope of Glory

1. (:1-4) No Condemnation but Freedom from Sin and Death –
In Christ there Is No Condemnation But Freedom to Live a New Life of Righteousness by the Power of His Spirit
 - a. (:1-2) True Liberation –
In Christ, We Are No Longer Condemned but Freed by Christ's Life-Giving Spirit
 - 1) (:1) No Condemnation

- 2) (:2) Freedom from Bondage
 - b. (:3) Total Deliverance –
 - God Sent his Own Son to Do What the Law Could Not
 - 1) Inability of the Law
 - 2) Intervention of God’s Son
 - 3) Indictment on Sin
 - c. (:4) Transformed Lives – God’s Intent Is to Have Us Live Righteous Lives through the Power of His Spirit
 - 1) Purpose of Christ’s Sacrifice
 - 2) Potential for Transformed Living
- 2. (:5-13) Contrast between Walking in the Spirit vs the Flesh – The Inclination of Our Heart Is Revealed by Whether We Walk in the Spirit or in the Flesh
 - a. (:5-8) Our Walk Reflects our Mindset
 - 1) (:5) What Is Our Mindset?
 - 2) (:6) What Is Our Disposition?
 - 3) (:7-8) What Characterizes the Mind Set on the Flesh?
 - b. (:9-11) Our Walk Reflects Whether the Holy Spirit Lives in Us – All Christians Have the Indwelling Spirit to Give Victory in Life Now and Resurrection Life Ultimately
 - 1) (:9) Do We Possess the Indwelling Holy Spirit?
 - 2) (:10) Dynamic Activity of the Indwelling Holy Spirit Promoting Righteous Living
 - 3) (:11) Resurrection Hope
 - c. (:12-13) Our Obligation Is to Walk in the Spirit – Walking in the Flesh Results in Death but Walking in the Spirit -- Life
 - 1) (:12) Consistent Obligation
 - 2) (:13) Two Possible Destinies
- 3. (:14-17) Assurance from Within – Identity / Intimacy / Inheritance – Our Heavenly Father Gave Us his Spirit to Reassure Us of Our Privileged Family Identity and Glorious Inheritance
 - a. (:14-15) Assurance Based on Identity as Adoption as Sons
 - 1) (:14) Inclination to Please God
 - 2) (:15) Intimate Family Relationship of Privileged Position
 - b. (:16) Assurance Based on Intimacy of Indwelling Holy Spirit Confirming Our identity as Children of God
 - c. (:17) Assurance Based on Promised Glorious Inheritance
 - 1) Promised Future Heirs with Christ
 - 2) Present Suffering with Christ in Anticipation
- 4. (:18-39) Perspective towards Suffering
 - a. (:18-25) We Can Patiently Endure Sufferings Because of Our Sure Hope that They Will End in a Far Surpassing Glory
 - 1) (:18) Future Glory Far Surpasses Present Suffering
 - 2) (:19-22) Fractured Creation Longs for End Time Redemption
 - a) (:19) Anxious Anticipation
 - b) (:20-21) Appointment from Futility to Freedom

- c) (:22) Agitated Anguish
 - 3) (:23-25) Fractured Believers Long for the Redemption of the Body
 - a) (:23) Entrapment in Suffering Bodies Causes Groaning for Redemption
 - b) (:24-25) Essence of Hope Requires Perseverance
- b. (:26-27) The Holy Spirit Intercedes for us –
The Compassionate Intercession of the Holy Spirit Helps Keep Us on Track as We Endure the Sufferings of This Life on Our Way to Glory
 - 1) (:26a) The Holy Spirit Helps Us Right Now in Our Weakness in Prayer in the Context of Suffering
 - 2) (:26b) The Holy Spirit Intercedes for Us
 - a) Our Weakness in Prayer
 - b) The Holy Spirit's Strength in Prayer
 - 3) (:27) The Holy Spirit Asks for the Exact Things We Need in Harmony with God the Father
 - a) God the Father Intimately Knows God the Spirit
 - b) God the Spirit Intimately Knows God the Father
- c. (:28-30) God's Unbreakable Chain of Salvation –
Provides Eternal Security and the Assurance that God Is Working All Things Together for Our Good
 - 1) (:28) Conviction Regarding God's Sovereign Demonstration of Goodness towards His Family
 - a) Determining Principle of God's Will
 - b) Directed towards Believers
 - 2) (:29-30) Confirmation of God's Goodness Demonstrated in His Sovereign Plan of Salvation from Beginning to End
 - a) (:29a) Election
 - b) (:29b) Predestination
 - c) (:30a) Calling
 - d) (:30b) Justification
 - e) (:30c) Glorification
- d. (:31-39) God is for Us – No Possible Separation –
No Matter What We Face, Since God Is for Us there is Nothing Strong Enough to Separate us from the Love of God
 - 1) (:31-32) Nothing Can Defeat Us Since God Is on Our Side
 - a) (:31) Thesis Statement = God Is for Us
 - b) (:32) Supporting Argument = God Will Bring Us to Glory
 - 2) (:33-34) Nothing Can Condemn Us Since God Is on Our Side
 - a) (:33a) Remember Our Protected Identity = the Elect of God
 - b) (:33b) Remember the Judge (God the Father) Is on Our Side
 - c) (:34) Remember God the Son Is on Our Side – His Fourfold Ministry
 - 3) (:35-39) Nothing Can Separate Us from God's Love

- a) (:35-36) Don't Let Suffering Catch You by Surprise
- b) (:37) Suffering Actually Magnifies Our Victory and Security
- c) (:38-39) The Strongest Power Imaginable Can Never Separate Us from God's Love

V. (9:1 - 11:36) THERE IS NO ROOM FOR BOASTING BECAUSE GOD'S GREAT PLAN OF SALVATION UNFOLDED THROUGHOUT THE AGES DISPLAYS HIS SOVEREIGN GRACE AND JUDGMENT TO BOTH JEWS AND GENTILES

A. (9:1-33) Israel's Past Election – Emphasis on God's Sovereignty

- 1. (9:1-13) Israel's Failure Cannot Compromise God's Faithfulness – The Sad Failure of the Nation Israel Does Not Contradict the Sovereignty of God in Choosing the Recipients of His Gracious Promises
 - a. (:1-5) Sadness – Because Israel Has Failed to Take Advantage of Their Spiritual Privileges
 - 1) (:1-4a) Sadness of Apostle Paul Embraced – Burden for Lost Souls
 - 2) (:4b-5) Spiritual Privileges of National Israel Not Embraced
 - b. (:6-9) Success – Because God Has Not Failed in His Revealed Plan to Save the Children of Promise – Example of Isaac
 - 1) (:6a) Culpability Does Not Lie with God's Word
 - 2) (:6b-8) Clarification Regarding Identity of the Children of Promise
 - 3) (:9) Confirmation of God's Word of Promise
 - c. (:10-13) Sovereign Choice – Because Whom God Saves Depends Completely on God – Example of God's Choice of Jacob over Esau
 - 1) (:10) One Act of Conception between Rebekah and Isaac
 - 2) (:11) Destiny of Twins Determined by God's Sovereign Choice
 - 3) (:12) Primacy of Firstborn Supremacy Overturned
 - 4) (:13) Distinction in God's Treatment of Jacob and Esau
- 2. (9:14-24) God's Inalienable Rights – We Have No Business Questioning God's Sovereign Choice in Salvation (Exercising His Right to Selectively Forgive Some But to Condemn Many)
 - a. (:14-18) Is God Unjust? Election Is Consistent with God's Character
 - 1) (:14) Thesis Statement
 - 2) (:15-16) Example of God's Sovereign Dealings with Moses
 - 3) (:17-18) Example of God's Sovereign Dealings with Pharaoh
 - b. (:19-21) Can Man Still Be Held Accountable? Election Is Consistent with Man's Responsibility
 - 1) (:19) Logical Question: Can Man Be Held Accountable
 - 2) (:20-21) Answer from Creation
 - c. (:22-23) Why Does God Delay His Wrath? God's Patience Magnifies His Selective Mercy
 - 1) (:22) God's Purpose for Vessels of Wrath
 - 2) (:23) God's Purpose for Vessels of Mercy
- (:24) Transition – Inclusion of the Called Gentiles

3. (9:25-33) Gentiles Grafted In . . . Jews Restricted to Small Remnant –
As the OT Prophets Promised, God Has Chosen to Sovereignly Save Many Gentiles
through Faith in Christ But Only a Remnant of Jews in This Age

- a. (:25-26) Salvation Extended to Many Gentiles
 - 1) (:25) Incorporation of Gentiles as God's Beloved People
 - 2) (:26) Incorporation of Gentiles into Family of God
- b. (:27-29) Salvation Restricted to Small Jewish Remnant
 - 1) (:27) Expectation of Salvation of Only a Small Remnant
 - 2) (:28) Expectation of Decisive Judgment
 - 3) (:29) Expectation of Almost Being Completely Devastated
- c. (:30-33) Israel Stumbled over Salvation by Faith in Jesus Christ
 - 1) (:30-31) Contrast between Pursuit of the Gentiles and the Jews
 - 2) (:32a) Core Distinction = Faith vs. Works
 - 3) (:32b-33) Christ = Stumbling Stone for the Jews

B. (10:1-21) Israel's Present Rejection – Emphasis on Man's Responsibility

1. (10:1-13) The Simplicity of Salvation in Christ –
Salvation is Easy – Whoever Trusts in Christ's Righteousness and Not In His Own
Will Be Saved

- a. (:1-4) Salvation Eludes Those Who Try to Earn It –
Sadly, Israel Did Not Accept the Righteousness of Christ,
But Tried Very Hard to Earn Their Salvation
 - 1) (:1) Burden for Lost Countrymen
 - 2) (:2-3) Blame Falls on Israel
 - 3) (:4) Basis for Salvation = Christ is the Goal – Providing
Righteousness via Faith
- b. (:5-10) Salvation Involves Simple Faith and Confession Regarding
the Finished Work of Christ
 - 1) (:5) Impossibility of Gaining Salvation by Obedience
to the Law
 - 2) (:6-7) Implications of Incarnation and Resurrection of Christ –
Righteousness Based on Faith Depends on the Finished Work of
Christ
 - 3) (:8-10) Instruction Regarding God's Plan of Salvation
- c. (:11-13) Salvation Extends to All Who Will Believe without Exception
and without Distinction
 - 1) (:11) Salvation Never Disappoints
 - 2) (:12-13) Salvation Is for All Who Will Believe

2. (10:14-21) Inexcusable Jewish Rejection of Worldwide Gospel Proclamation –
God Sent the Good News of Salvation to the World

- The Gentiles Received It (Provoking Israel)
 - But Israel Stubbornly Rejected It
- a. (:14-17) Salvation Depends on Faith Response to Gospel Proclamation
 - 1) (:14-15) Causal Chain of Gospel Proclamation and Response
 - 2) (:16) Chink in the Chain = Failure of Jews to Respond in Faith
 - 3) (:17) Connection between Faith, Hearing and Proclamation

of the Gospel

- b. (:18-20) No Excuses for Jewish Rejection
 - 1) (:18) Jewish Rejection Cannot Be Blamed on Lack of Revelation
 - 2) (:19-20) Jewish Rejection Cannot Be Blamed on Any Hidden Agenda Regarding Gentile Inclusion
- c. (:21) Salvation Stubbornly Rejected by Rebellious Israel
 - 1) Persistent Reaching Out to Israel with Gospel Invitation
 - 2) Persistent Rebellion by Stubborn Israel

C. (11:1-32) Israel's Future Reception – Emphasis on God's Faithfulness and Mercy

- 1. (11:1-10) Israel: Down But Not Out – A Remnant Still Exists – God's Rejection of His Chosen Nation Israel Has Never Been Total
 - a. (:1-6) God's Grace Has Preserved a Remnant in Israel
 - 1) (:1a) Key Question: Has God Rejected Israel Completely and Permanently?
 - 2) (:1b) Quick Answer
 - 3) (:2-6) Corroboration from God's Gracious Choice Demonstrated in History
 - b. (:7-10) God's Hardening Reinforces the Stubborn Rebellion of Most of Israel
 - 1) (:7) Salvation Depends on God's Sovereign Choice
 - 2) (:8-10) Spiritual Dullness Results from Divine Hardening
- 2. (11:11-24) Israel's Loss = Gentiles' Gain – Israel's Rejection Brought Salvation to the Gentiles and Will Ultimately Result in Israel's Acceptance
 - a. (:11-16) Israel's Loss Led to Gain for the Gentiles and Her End Time Acceptance Will Mean Even Greater Gain
 - 1) (:11a) Basic Question: Is Israel's Rejection Permanent?
 - 2) (:11b) Benefit of Israel's Temporary Rejection
 - 3) (:12-16) Bright Future for Both Jews and Gentiles
 - b. (:17-21) No Room for Pride or Boasting – Just Fear of the Lord
 - 1) (:17-18) Gentiles Must Not Be Arrogant But Respect Israel's Heritage
 - 2) (:19-21) Gentiles Must Not Be Conceited But Fear God
 - c. (:22-24) Don't Forget God's Kindness, Severity and Ability
 - 1) (:22) God's Kindness and Severity
 - 2) (:23-24) God's Ability – Argument from the Greater to the Lesser
- 3. (11:25-32) Israel's Final Salvation – Rejection Only Temporary – God's Rejection of the Nation Israel Is Not Final – All Israel Will Be Saved after the Fullness of the Gentiles
 - a. (:25-27) God Will Eventually Save All Ethnic Israel
 - 1) (:25a) Antidote for Pride = Understanding God's Revealed Mystery
 - 2) (:25b) End Point of Israel's Temporary Partial Hardening = Fullness of the Gentiles
 - 3) (:26a) Consummation of God's Redemptive Program for

- Ethnic Israel
- 4) (:26b-27) Prophetic Confirmation of God's Covenant Commitment to Israel
- b. (:28-29) God Remains Committed to Ethnic Israel
 - 1) (:28) Commitment Based on Sovereign Election and Divine Love
 - 2) (:29) Commitment Based on the Faithfulness of God
- c. (:30-32) God Delights in Showing Mercy to the Disobedient = the Heart of His Redemptive Plan for Both Jews and Gentiles
 - 1) (:30-31) Mercy for Both Disobedient Gentiles and Jews
 - 2) (:32) Mercy for All Disobedient God's Elect

**(11:33-36) Theology Bursts Forth in Doxology – To God Be the Glory!
 God's Great Plan of Salvation Deserves our Praise Because It Glorifies God's
 Inscrutability, Autonomy and Sovereignty**

- 1. (:33-34) Praising God's Inscrutability – His Unfathomable Wisdom and Knowledge
 - a. (:33a) Infinite Wisdom and Knowledge
 - b. (:33b) Inscrutable Judgments and Ways
 - c. (:34) Inaccessible Mind of God
- 2. (:35) Praising God's Autonomy
 - a. Source -- Everything Originates from God -- Creator
 - b. Means -- Everything Operates through God's Agency -- Sustainer
 - c. Goal -- Everything Works Together to Accomplish God's Purposes
- Omega
- (:36b) All for the Glory of God

VI. (12:1 - 15:13) ALL BELIEVERS MUST HUMBLY SERVE GOD TOGETHER AND LOVE ONE ANOTHER AS MEMBERS OF THE ONE BODY OF CHRIST IN ORDER TO PROMOTE THE WORLDWIDE MESSAGE OF THE GOSPEL

**A. (12:1-8) Dedicated Service in Unity through Diversity –
 We Are Called to Serve God through Serving in His Body**

- 1. (:1-2) Serving God –
 Offering Ourselves as Living Sacrifices Pleases God
 and Enables Us to Experience His Perfect Will
 - a. (:1a) Our Motivation to Serve God
 - b. (:1b) Our Dedication to Serve God
 - c. (:2a) Our Transformation to Serve God
 - d. (:2b) Our Goal to Serve God
- 2. (:3-8) Through Serving in His Body –
 As Members of the Same Body We Are Called to Serve Wholeheartedly
 in Our Gifted Role
 - a. (:3) Transformed Thinking about Ourselves –
 To Properly Balance Humility and Faith
 - b. (:4-5) Transformed Thinking about Others –
 To Promote Unity via Diversity in the Body

- c. (:6-8) Transformed Thinking about Our Gifts –
To Exercise Our Unique Giftedness to Build Up the Body

B. (12:9-21) Divinely Commanded Love

- 1. (:9-13) Love in Action – Authentic and Active Love –
We Are to Serve God with Love that is Both Authentic and Active
 - a. (:9a) Love Must Be Authentic (Genuine, Sincere)
 - b. (:9b-13) Love Must Be Active (Practical)
 - 1) (:9b) Pursue Holiness – Love’s Morality
 - 2) (:10) Prefer Others – Love’s Concern for Others
 - 3) (:11) Passionate in Service – Love’s Zeal for Serving the Lord
 - 4) (:12) Persevere in Affliction – Love’s Staying Power
 - 5) (:13) Provide for the Needs of Others – Love’s Material Giving
- 2. (:14-21) Love towards Enemies -- Overcome Evil with Good –
We Are to Serve God by Overcoming Evil with Good –
7 Ways to Fight Your Enemies
 - a. (:14) Bless Them –
Determine to Bring Your Enemy Good Not Harm
 - b. (:15) Empathize with Them –
Show Concern for Your Enemy’s Gains and Losses
 - c. (:16) Show Humility –
Do Not Allow Yourself to Think You Are Better
 - d. (:17) Avoid Retaliation –
Do Not Allow Another’s Evil to Determine Your Response
 - e. (:18) Maintain Peace –
Always Try to Maintain an Atmosphere of Peace
 - f. (:19) Leave Vengeance to God –
Let God “Worry” about Repaying Evil
 - g. (:20) Meet Practical Needs –
Give Your Enemy What He Needs Not What He Deserves
 - (:21) Summary – Overcome Evil with Good

C. (13:1-7) Submission to Divinely Appointed Civil Authority –

We Are to Serve God by Submitting to Civil Government which Uses Its Delegated Power to Promote Good and Restrain Evil

- 1. (:1-2) Power of Civil Authority Requires Submission
 - a. (:1a) Power that Demands Submission
 - b. (:1b) Power that Is Delegated from God
 - c. (:2) Power that Is Directed against All Resistance and Opposition
- 2. (:3-5) Purpose of Civil Authority Requires Submission
 - a. (:3-4) External Motivation to Submit = Avoidance of Wrath
 - b. (:5) Internal Motivation to Submit = Consciousness of God’s Will
- 3. (:6-7) Practical Application (Examples) of Submission to Governing Authorities
 - a. (:6) Specific Example: Paying Taxes
 - b. (:7) General Examples: Render What Is Due

D. (13:8-14) Love Must Be the Essence of Christian Conduct Since Christ Will Soon Return – We Are to Serve God By Loving One Another While We Still Have Opportunity

1. (:8-10) Love Fulfills Every Command of God
 - a. (:8) Love Fulfills the Law by Paying Our Obligation to Our Neighbor
 - b. (:9) Love Fulfills the Law by Treating Your Neighbor as Yourself
 - c. (:10) Love Fulfills the Law by Doing No Wrong to Our Neighbor
2. (:11-14) Love Seizes Life's Fading Opportunities to Display Jesus Christ – Understanding the Times Urges Right Living
 - a. (:11-12a) Understanding the Times = Life's Fading Opportunities
 - b. (:12b-14) Urges Right Living = Display Jesus Christ

E. (14:1-23) Love Means Accepting All Brethren while Restricting Personal Liberty

1. (:14:1-12) Accepting Brethren with Differing Convictions – We Are to Serve God Our Ultimate Judge by Allowing Fellow Believers the Freedom to Hold Differing Personal Convictions in Disputable Matters
 - a. (:1-3) Accept Fellow Believers Despite Differing Convictions -- Case Study #1 – Eating Meat vs Just Vegetables
 - 1) (:1) Acceptance without Passing Judgment
 - 2) (:2) Application to Specific Cultural Issue = Dietary Convictions
 - 3) (:3) Analysis
 - b. (:4-12) Allow Fellow Believers the Freedom to Be Accountable to God and Not to Us -- Case Study #2 – Observing Special Days
 - 1) (:4) Live in Light of Personal Accountability
 - 2) (:5-9) Live in Light of Conscience, Thanksgiving and Submission
 - 3) (:10-12) Live in Light of Ultimate Accountability
2. (14:13-23) Love Trumps Liberty – In Issues of Personal Conviction, Love Must Take Precedence over Liberty to Promote Peace and Prevent Stumbling Blocks
 - a. (:13) Love Replaces Judgment with Brotherly Sensitivity
 - 1) Don't Judge Your Brother for His Personal Convictions
 - 2) Don't Exercise Your Liberty in a Way that Trips Up Your Brother
 - b. (:14-18) Love Keeps the Main Thing the Main Thing
 - 1) (:14) Respect Differing Personal Convictions
 - 2) (:15) Restrict Your Liberty to Avoid Harming Your Brother
 - 3) (:16) Regard the Impact of Your Behavior
 - 4) (:17) Remember the Essentials of the Kingdom
 - 5) (:18) Receive the Approval of God and Men
 - c. (:19-21) Love Sacrifices Liberty for Harmony and Edification
 - 1) (:19-20a) Seek Harmony and Edification
 - 2) (:20b) Stumbling Your Brother is an Evil
 - 3) (:21) Self Restraint is a Virtue
 - d. (:22-23) Love Does Not Pressure or Compromise in Areas of Personal Conviction
 - 1) (:22a) Personal Convictions Should Govern Your Behavior, Not Pressure Others

2) (:22b-23) Personal Convictions Should Not Be Compromised

F. (15:1-13) Spiritual Superglue

1. (15:1-6) Spiritual Superglue – Part 1

The Strong and the Weak Glorify God When Held Together by Unselfishness and Divine Encouragement

- a. (:1) Encourage the Weak Rather than Flaunting Your Liberty
 - 1) By Respecting the Weak
 - 2) By Restricting Our Liberties
- b. (:2-3) Edify One Another Rather than Living for Self
 - 1) (:2) Unselfish Orientation in Conduct
 - 2) (:3) Unselfish Example of Christ
- (:4) Aside: Value of OT History
 - 1) Authority of OT Scripture
 - 2) Purpose of Instruction
 - 3) Process of Perseverance and Encouragement
 - 4) Goal = Hope
- c. (:5-6) Embrace God's Resources to Facilitate Unified Fellowship and Worship
 - 1) (:5) The Gift = Unified Fellowship
 - 2) (:6) The Goal = Unified Worship

2. (15:7-13) Spiritual Superglue – Accept All Based on the Ministry of Christ – The Ministry of Christ Brings Glory to God by Uniting Jews and Gentiles Together in Praise and Hope

- a. (:7) Plea for Mutual Acceptance (Despite Differences) Based on the Ministry of Christ
- b. (:8-9a) Purpose of the Ministry of Christ to Both Jews and Gentiles
 - 1) Ministry of Christ
 - 2) Twofold Purpose
 - a) (:8) Purpose to the Jews – Confirming OT Covenant Promises to the Patriarchs – God's Faithfulness
 - b) (:9a) Purpose to the Gentiles – Causing Praise for God's Mercy for Inclusion – God's Mercy
- c. (:9b-12) Prophetic Support for Gentiles Being Included in Mutual Worship – 4 OT Quotations
 - 1) (:9b) Psalm 18:49; 2 Sam. 22:50
 - 2) (:10) Deut. 32:43
 - 3) (:11) Psalm 117:1
 - 4) (:12) Isaiah 11:10
- d. (:13) Prayer for Joy and Peace Stimulating Abundant Hope
 - 1) Joy and Peace in Mutual Faith
 - 2) Stimulating Abundant Hope
 - 3) Accomplished by the Power of the Holy Spirit

VII. (15:14 - 16:27) CLOSING GREETINGS/WARNINGS -- FELLOWSHIP IN THE LORD BINDS BELIEVERS TOGETHER IN PROMOTING THE GOSPEL WORLDWIDE WHILE GUARDING AGAINST ATTACK AND DECEPTION

A. (15:14-21) Paul's Mission and Travel Plans

1. (15:14-21) Paul's Mission
 - a. (15:14-16) Bold Gospel Ministry Mandated by God's Grace Seeks the Growing Maturity of the Saints despite Confident Commendation
 - b. (15:17-21) Reflecting on Past Ministry Should Cause us to Give All Credit to God
2. (15:22-33) Paul's Travel Plans
 - a. (15:22-29) Paul's Immediate Ministry Plans – Spiritual Ministry Lays the Foundation for Mutual Fellowship that Responds to Material Needs and Promotes the Extension of the Gospel
 - b. (15:30-33) Prayer Partners in the Warfare of Spiritual Ministry – Successful Ministry Depends on Urgent Intercessory Prayer

B. (16:1-16) Commendation and Multiple Greetings

1. (:1-2) Commendation of the Letter's Courier – Phoebe – the Ultimate Helper
2. (:3-16) Multiple Greetings – Blessed Be the Tie that Binds

C. (16:17-23) Closing Warning and Final Greetings

1. (:17-20) 4 Safeguards against Doctrinal Troublemakers
 - a. (:17) Caution – Watch Out
 - b. (:18) Discernment – Don't Be Deceived
 - c. (:19) Careful Obedience -- Look before You Leap
 - d. (:20a) Perseverance in Hope – Hang in There
 - (:20b) Grace Benediction
2. (:21-23) Final Greetings
(16:24 – Not in the earliest Greek manuscripts)

(16:25-27) Final Doxology of Celebration of God's Glory

"Now to Him who is able to establish you by my gospel and the proclamation of Jesus Christ, according to the revelation of the mystery hidden for long past, but now revealed and made known through the prophetic writings by the command of the eternal God, so that all nations might believe and obey Him-- to the only wise God be glory forever through Jesus Christ! Amen."

TEXT: ROMANS 1:1-7

TITLE: GOD'S CALL TO GOSPEL MINISTRY

BIG IDEA:

GOD'S CALL PROMOTES GOSPEL MINISTRY --

7 ESSENTIALS OF GOD'S CALL FOR THE APOSTLE PAUL (AND FOR YOUR LIFE)

INTRODUCTION:

Douglas Moo: Ancient letters typically began with a simple identification of the sender, the recipients, and a greeting. New Testament letters follow this pattern, but often elaborate by adding distinctly Christian nuances. No New Testament letter shows as much elaboration as Romans. Perhaps because he is writing to a church he has never visited before, Paul spends six verses identifying himself before he mentions the recipients (v. 7a) and extends them a greeting (v. 7b).

Frank Thielman: He seems especially concerned for his Roman readers to know why he considers it appropriate to write such a letter to them (1:5–6) and that the gospel he will proclaim in the letter has its foundations in the Scriptures that both he and they consider authoritative (1:2–4). . . . Paul probably had in mind the practical impact his proclamation of the gospel in the letter would have on the **disunity** that had affected Roman Christianity. Some gentile believers there had adopted an attitude of arrogance toward Jewish unbelievers (11:18), and people within the Roman Christian community were divided over matters of diet and Sabbath observance (14:1–15:7). The whole community needed to hear again the gospel that transforms one's thinking and, in the process, **eliminates boasting** in any humanly conceived badge of honor (12:2–3), whether one's ethnic group (3:27–30), one's special piety (4:1–8; 11:5–6), or even one's good judgment in embracing the gospel (11:17–21). . . .

The length and structure of the letter's opening, then, sets the tone for a document of **immense gravitas**. It communicates that the letter's author is the official messenger of God himself and that the message he brings concerns the fulfillment, through the Lord Jesus Christ, of God's purposes for the world. These purposes require an obedient response of faith not just from Jews but also from gentiles. Because the Christians in Rome have believed the gospel, God has also summoned them to live in a distinctive way within the unbelieving world.

Michael Bird: Paul introduces himself to the Roman churches. Paul wastes no time and hits the ground running in this letter by bringing up that which matters most: the gospel and the cause of the gospel, which he endeavours to promote as an apostle. Ultimately, Paul wants to make sure that he and the Roman Gentile Christians are singing off the same sheet of gospel music. Since Paul cannot be in Rome in person, he wants to embed the gospel in their community, to defend himself against any rumor of antinomianism or anti-Israelite sentiment, and to prevent a diverse and potentially fractious Christian community from fragmenting along ethnic lines of Jew versus Gentile. In other words, Paul wants to gospelize the Romans, that is, to conform them to the pattern of teaching that the gospel imparts. Paul pursues this for the sake of unity with the

Roman churches and for the promotion of the gospel in a wider pan-Roman theater that reaches from Jerusalem all the way around to Spain.

Greg Herrick: The apostle Paul was unreservedly committed to Christ and to the ministry of the gospel. He regarded himself as called to both his master's side and to the promulgation of the good news—news inextricably bound up with the death, resurrection, and exaltation of his Lord and God's richest blessing upon sinful, erring human beings. In short, his self-construal was—and always will be—since the Damascus road anyway, one who was a free and willing slave of the Lord Jesus Christ. Undoubtedly, he could think of no higher calling and privilege. . .

The actual introduction to Romans begins in **1:1** and ends in **1:17**. This unit itself, however, can be broken down into three distinct, yet related sections.

- The first section is the salutation proper in **1:1-7**. It concerns Paul's apostolic calling and mission, along with his heartfelt, yet semi-typical greeting given to a church.
- The second section is **1:8-15** and concerns Paul's desires and plans to visit the church in Rome.
- The third section, namely **1:16-17**, concerns the power of the gospel. It serves as a thematic outline for the entire book.

I. (:1a) OWNED BY THE MASTER – SENDER OF THE EPISTLE

“Paul, a bond-servant of Christ Jesus,”

Security that comes from knowing we belong to Christ; leads to dedicated service

Thomas Constable: As in all his epistles, Paul used his Roman rather than his Jewish name, Saul, perhaps because he was the apostle to the Gentiles. Even though he had not yet visited Rome, his readers knew Paul's reputation well. He just needed to give his name to identify himself.

Thomas: He [Paul] regarded himself as the purchased possession of his Lord and Master. The two ideas of **property** and **service** are suggested. There was no serfdom or servility, and yet there was an absolute loyalty in the consciousness of absolute possession. The bond-servant owned nothing, and was nothing, apart from his master. His time, his strength, everything belonged altogether to another. There was nothing nobler to St. Paul than to be a slave of the Lord Jesus. He desired to be nothing, to do nothing, to own nothing apart from Him.

II. (:1b) PLUGGED INTO GIFTED MINISTRY

“called as an apostle,”

- Delegated authority by Christ, the Head of the Church
- Deputized on a mission

Frank Thielman: Paul's elaborate emphasis on his **authority** at the letter's beginning shows that he wrote in an official capacity and in order to carry out a mandate.

John Toews: The verb *called* expresses **divine calling** in opposition to human self-appointment. *Apostle* denotes an authorized agent or representative. Paul is a *slave*, like many readers in his audience, who has been called to represent God.

III. (:1c-4) DEDICATED TO THE GOSPEL OF GOD

A. Nature of the Gospel

1. Defined as Good News

"set apart for the gospel"

John MacArthur: Is there any **good news**? Really good news? Good news about sin: That it can be dealt with? Good news about selfishness: That you don't have to live that way? Good news about guilt and anxiety: That it can be alleviated? Is there any good news about the meaning of life? Is there any good news about the future, life after death? Is there any good news?

I submit to you that Paul says in **verse 1**, there's good news; and that's **the gospel, the good news of God**. And that is what Romans is about. Paul begins in **verse 1** with the good news of God. And in **chapter 15**, as he draws to an end, in **verse 16** he says: "*I, the minister of Jesus Christ to the Gentiles, ministering the good news of God.*" So bracketing this epistle is the great reality that Paul is bringing good news, good news.

2. Directed by God

"of God"

Douglas Moo: But the "*setting apart*" probably refers to the time when God called him on the Damascus Road to come into relationship with Christ and to proclaim him to both Jews and Gentiles (**Acts 9:1–19**, esp. **vv. 15–16**; note the use of this same verb in **13:2**). The "*gospel*" is the central, unifying motif of Romans, and Paul signals its importance by referring to it three other times in the introduction to the letter (**vv. 9, 15, 16**). God has appointed Paul to the special task of proclaiming and explaining the good news of God's intervention in Jesus Christ.

John Murray: "*Separated unto the gospel of God*" is parallel to "*called to be an apostle*". The separation here spoken of does not refer to the predestination of Paul to the office, as in **Galatians 1:15**, but to the effectual dedication that occurred in the actual call to apostleship and indicates what is entailed in the call. No language could be more eloquent of the decisive action of God and of the completeness of Paul's resulting commitment to the gospel. All bonds of interest and attachment alien or extraneous to the promotion of the gospel have been cut asunder and he is set apart by the investment of all his interests and ambitions in the cause of the gospel. It is, of course, implied that the gospel as a message is to be proclaimed and, if we were to understand the "*gospel*" as the actual proclamation, dedication to this proclamation would be an intelligible and worthy conception. However, the word "*gospel*" is not used in the sense of the act of proclaiming; it is the message proclaimed. And this is stated to be "*the gospel of God*" (cf. **Mark 1:14**). Perhaps the thought could be more aptly expressed in English by saying, "*separated unto God's gospel*". The stress falls upon the divine origin and character of the gospel. It is a

message of glad tidings from God, and it never loses its divinity, for it ever continues to be God's message of salvation to lost men.

B. (:2) Promise of the Gospel

“which He promised beforehand through His prophets in the holy Scriptures,”

George Ladd: Paul frequently appealed to the Old Testament in support of his teaching, quoting from it ninety-three times.

Van Parunak:

- 1:2 – the origin of the gospel.
- 1:3-4 – the subject of the gospel.
- 1:5-6 – the propagation of the gospel.

John MacArthur: You'll recall that the apostle Paul was accused of being anti-Jewish. The Judaizers went around condemning Paul and condemning his message because they said, he's anti-Jewish, he speaks against Moses, he speaks against the law, he speaks against this people, he speaks against the temple. They accused him in **Acts 21** of dragging Gentiles into the inner area of the temple where they were forbidden to go. They accused him of desecrating Moses. They accused him of denying circumcision and the sustaining of the law. They were saying, he preaches some new, some revolutionary new message that is no way connected to traditional Judaism. And so, Paul, in order to put the record straight, says the good news of God which I preach is not new good news; it's old good news that was indicated to us in the promises of the prophets who wrote in holy Scripture.

C. (:3-4) Focus of the Gospel = Jesus Christ

- 1. (:3a) Relationship to God the Father
“concerning His Son,”

John Murray: Jesus is here identified by that title which expresses his eternal relation to the Father and that when the subject matter of the gospel is defined as that which pertains to the eternal Son of God the apostle at the threshold of the epistle is commending the gospel by showing that it is concerned with him who has no lower station than that of equality with the Father. The subject matter of the gospel is the person who is on the highest plane of reality.

- 2. (:3b-4b) Relationship to God's Historic Redemptive Program

John Toews: The confession also may be diagrammed structurally as two parallel verses centered in the phrase *in power*.

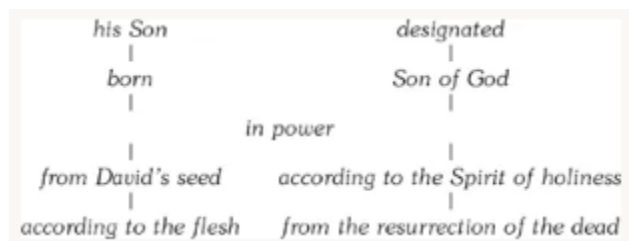

The center of the confession affirms Jesus as the Messiah in two titles, **seed of David** and **Son of God**. The confession says one thing about Jesus in two different ways. The first line confesses Jesus as the Davidic Messiah, as the fulfillment of Jewish messianic hopes. The second line declares Jesus as the Messiah in more exalted terms.

The one phrase that is without parallel in the confession, and stands at the center of the confession, is *in power*. Jesus was enthroned as Son of God in power by the end-time Spirit by means of the resurrection. An act of end-time power is described. The evidence was the inauguration of the end-time resurrection of the dead. The center of the confession is a statement about Spirit power that enthrones Jesus as Son of God and Lord. The emphasis on power attunes Paul's audience to what such power might mean and promise. Paul answers that expectation at the outset by declaring that the gospel is power, end-time power (**1:16**), and in his benediction by asserting that hope abounds and the gospel is spread because of the power of the Spirit (**15:13, 19**). **Romans is about power**; the letter is bracketed by power language, particularly the confession of **1:4**, the theme of **1:16**, and the benediction of **15:13, 19**.

Michael Bird: It is likely that this is a short summary of the gospel that Paul himself received (perhaps it was an early creed, hymn, prose, or confession of faith given the non-Pauline language). It is probably the case that this gospel summary was already known to the Roman churches so that Paul quotes it to affirm their sharing of a common gospel tradition. In these brief verses we are instantly struck by its forthright announcement about the messianic identity and sovereign name of Jesus. The gospel here is the declaration that Jesus is the climax of Israel's hopes, he is installed as God's vice-regent, and his resurrection has inaugurated the beginning of the end of the ages.

- a. (:3b) His Incarnation Made Him Fully Human as the Promised Messiah
"who was born of a descendant of David according to the flesh,"

John MacArthur: The good news is God became a man. God became a man. A real man, He came into the world born in a family like all of us have a family, with flesh like we have flesh. He was actually born of a virgin, but nonetheless born of Mary.

Why? That He might become one of us according to the flesh, that He might have that perfect humanness, that He might be a sympathetic high priest, that He might succor us, that He might understand us, that He might be at all points tempted like as we are yet without sin, that He might be a man who could die for men, who could take the place of men, who could substitute for men, who could bear the brunt of God's wrath for men. He had to be a man. And He wasn't just any man. Look what it says. He was of the seed of David. It wasn't just any family, it was the right family, it was the royal family, the only family that had a right to rule in the land, a right to establish the throne on Mount Zion in that holy hill in Jerusalem, the holy city, and from there to rule the world. He was the right man in the right family. If He hadn't been the son of David, He couldn't have been the Messiah. He would have contradicted **2 Samuel, chapter 7, Psalm 89, Isaiah 11, Jeremiah 23, Jeremiah 33, Ezekiel 33, Ezekiel 37**. All of them would have been contradicted if He had not been the son of the family of David. **So He was a man and He was the right man.**

- b. (:4a) His Resurrection Invested Him with Manifest Power
“*who was declared the Son of God with power
by the resurrection from the dead,*”

Frank Thielman: the term “*Son of God*” here refers to Jesus’s **function**: from the time of his resurrection he began to function as “*Son of God in power.*”

Frank Murray: In the history of interpretation this parallelism has been most frequently interpreted as referring to the differing aspects of or elements in the constitution of the person of the Saviour. . . It cannot, of course, be doubted that “*born of the seed of David according to the flesh*” has reference to the incarnation of the Son of God and therefore to that which he became in respect of his human nature. But it is not at all apparent that the other expression “*Son of God . . . according to the Spirit of holiness*” has in view simply the other aspect of our Lord’s person, namely, that which he is as divine in contrast with the human. There are good reasons for thinking that this type of interpretation whereby it is thought that reference is made to the distinguished aspects of our Lord’s human nature or of our Lord’s divine–human person is not the line to be followed but that the distinction drawn is that between “**two successive stages**” of the historical process of which the Son of God became the subject. . .

The apostle is dealing with some particular event in the history of the Son of God incarnate by which he was instated in a position of sovereignty and invested with power, an event which in respect of investiture with power surpassed everything that could previously be ascribed to him in his incarnate state. . . The apostle could still say that he was appointed Son of God with express allusion to the **new phase of lordship and glory** upon which Jesus as the incarnate Son entered by the resurrection without in the least implying that he then began to be the Son of God. The statement would be analogous to that of Peter, that by the resurrection God made Jesus “*both Lord and Christ*” (**Acts 2:36**). Peter cannot be understood to mean that then for the first time Jesus became Lord and Christ. He is referring to the new phase of his messianic lordship.

- c. (:4b) His Ascension Initiated His Mediatorial Rule by the Spirit
“*according to the Spirit of holiness,*”

Frank Thielman: God’s eschatologically given Spirit brings with it the holiness that is a necessary characteristic of God’s restored people.

John Murray: Just as “*according to the flesh*” in **verse 3** defines the **phase** which came to be through being born of the seed of David, so “*according to the Spirit of holiness*” characterizes the phase which came to be through the resurrection. And when we ask what that new phase was upon which the Son of God entered by his resurrection, there is copious New Testament allusion and elucidation (cf. **Acts 2:36; Eph. 1:20–23; Phil. 2:9–11; I Pet. 3:21, 22**). By his resurrection and ascension the Son of God incarnate entered upon a new phase of sovereignty and was endowed with new power correspondent with and unto the exercise of the mediatorial lordship which he executes as head over all things to his body, the church. It is in this same resurrection context and with allusion to Christ’s resurrection endowment that the apostle says, “*The last Adam was made life-giving Spirit*” (**I Cor. 15:45**). And it is to this that he refers elsewhere when he says, “*The Lord is the Spirit*” (**II Cor. 3:17**). “Lord” in this instance, as frequently in Paul, is

the Lord Christ. The only conclusion is that Christ is now by reason of the resurrection so endowed with and in control of the Holy Spirit that, without any confusion of the distinct persons, Christ is identified with the Spirit and is called "*the Lord of the Spirit*" (II Cor. 3:18). Thus, when we come back to the expression "*according to the Spirit of holiness*", our inference is that it refers to that **stage of pneumatic endowment** upon which Jesus entered through his resurrection. The text, furthermore, expressly relates "*Son of God with power according to the Spirit of holiness*" with "*the resurrection from the dead*" and the appointment can be none other than that which came to be by the resurrection. The thought of **verse 4** would then be that the lordship in which he was instated by the resurrection is one all-pervasively conditioned by pneumatic powers. The relative weakness of his pre-resurrection state, reflected on in **verse 3**, is contrasted with the **triumphant power** exhibited in his post-resurrection lordship. What is contrasted is not a phase in which Jesus is not the Son of God and another in which he is. He is the incarnate Son of God in both states, humiliation and exaltation, and to regard him as the Son of God in both states belongs to the essence of Paul's gospel as the gospel of God. But the pre-resurrection and post-resurrection states are compared and contrasted, and **the contrast hinges on the investiture with power** by which the latter is characterized.

John Harvey: When taken with the preceding phrase's reference to power and the following phrase's reference to the resurrection, therefore, the contrast is between Jesus's humiliation in taking on "flesh" and his exaltation as **the one with all power who sends the Holy Spirit**.

Alternative view:

Henry Alford: To what does "*the Spirit of holiness*" (v. 4) refer? It may be another way of referring to the Holy Spirit. On the other hand, in view of the parallel expression "*according to the flesh*" (v. 3), and the fact that Paul could have said Holy Spirit if that is what he meant, probably Paul was referring to the holy nature of Jesus. Jesus' nature was so holy (perfectly sinless) that **death could not hold Him**.

3. (:4c) Relationship to Believers "*Jesus Christ our Lord,*"

IV. (:5-6) CHALLENGED BY WORLDWIDE VISION

A. (:5a) Goal of Evangelizing Gentiles of All Nations

*"through whom we have received grace and apostleship
to bring about the obedience of faith among all the Gentiles,"*

Inclusion in the one body of Christ on an equal faith basis with believing Jews

Frank Thielman: It is precisely in his role as the Messiah and Lord, sovereign not only over Jews but over all the earth, that Jesus gave Paul the mission of proclaiming the gospel to the gentiles. .

"*obedience of faith*" -- It is likely, then, that Paul used this phrase to refer both to the obedience of believing the gospel (cf. 10:16; 11:23, 30–31) and to the obedience that arises from the powerful reign of God's grace in the believer's life (5:21; 6:1–23; 7:5–6; 8:4, 7–9).

Thomas Constable: Paul's point in this verse is not the obedience of Christians but the obedience of non-Christians who need to obey God by placing their faith in Christ.

John Murray: “*Obedience of faith*” could mean “*obedience to faith*” (cf. **Acts 6:7; II Cor. 10:5; I Pet. 1:22**). If “*faith*” were understood in the objective sense of the object or content of faith, the truth believed, this would provide an admirably suitable interpretation and would be equivalent to saying “obedience to the gospel” (cf. **10:16; II Thess. 1:8; 3:14**). But it is difficult to suppose that “*faith*” is used here in the sense of the truth of the gospel. It is rather the **subjective act of faith in response to the gospel**. And though it is not impossible to think of obedience to faith as the commitment of oneself to what is involved in the act of faith, yet it is much more intelligible and suitable to take “*faith*” as in apposition to “*obedience*” and understand it as **the obedience which consists in faith**. Faith is regarded as an act of obedience, of commitment to the gospel of Christ. Hence the implications of this expression “obedience of faith” are far-reaching. For the faith which the apostleship was intended to promote was not an evanescent act of emotion but the commitment of wholehearted devotion to Christ and to the truth of his gospel. It is to such faith that all nations are called.

John Harvey: A “plenary genitive” (both subj. gen. and obj. gen.) understanding might be best: “*obedience to the call of faith (the gospel) that results in a lifestyle of faithful obedience*” (cf. **Wallace** 119–21). The ambiguity honors both Jewish (obedience) and Gentile (faith) concerns in Rome (**Jewett** 110). By repeating the same phrase in **16:26**, Paul creates an **inclusio** that frames the letter (**Longenecker** 82).

Michael Gorman: As the letter unfolds, it will become clear that faith and obedience are not two separate responses to the gospel, one requiring or generating the other, but **one unified response** of obedient faith. Recent ways of rendering this phrase include “faithful obedience” (CEB), “believing obedience” (KNT), “believing allegiance,” and “covenantal believing allegiance.”

Bob Deffinbaugh: The scope of the Gospel which Paul preached was **universal** (vv. 5-7). The Jews wanted to keep the Gospel in their own little corner of the world. They wished to make it exclusively Jewish. If they could not succeed in doing so, at least they would insist that in order to be saved men must in effect become Jewish proselytes to Judaism (cf. **Galatians, Acts 15:1ff.**). Paul's primary calling was to preach the Gospel of Jesus Christ to the Gentiles (**v. 5**). Paul's concern for the salvation of the Gentiles explains, in part, his interest in writing to the Roman saints.

B. (:5b) Goal of Glorifying Christ “*for His name's sake,*”

John Murray: It is not the advantage of the nations that is paramount in the promotion of the gospel but the honour and glory of Christ.

Steven Cole: Paul's ultimate goal was to glorify the name of the Savior who gave Himself to redeem rebellious sinners.

This principle is so important to keep in mind in your service for Jesus Christ. It's easy to fall into the trap of serving Christ for personal fulfillment. It makes you feel good to help others. It feeds your pride when others tell you how kind or generous or caring you are. But then someone criticizes you because you didn't meet his expectations or you neglected to do something in the right way. Or you don't receive the thanks that you thought you deserved. Your feelings get hurt and your pride is deflated. But, also, your motive for serving gets exposed. You weren't serving for *His* name's sake. You were serving for *your* name's sake!

C. (:6) Goal of Discipleship to Jesus Christ

"among whom you also are the called of Jesus Christ;"

John MacArthur: We're *called*. And that is the **effectual call**. That is referring to the actual call to salvation. And we'll see that in detail when we get to **chapters 9 and 10**. But we have been called. We are saved because of the **sovereign act of God**. This isn't referring to some general external call. Not just the proclamation as in **Isaiah 45**, "*Be ye saved all the ends of the earth*," or **Isaiah 55**, "*Seek the Lord while He may be found*." This isn't just the general call like **Ezekiel 33** when He cried, "*Turn ye, turn ye*," or **Matthew 11** where Jesus said, "*Come unto Me all ye that labor*," or **John 7**, "*If any man thirst, let him come unto Me and drink*," or **Revelation 22**, "*And the Spirit and the bride say, 'Come'*," or **Romans 10**, "*Faith comes by hearing a speech about Christ*." It isn't just that general calling out of the gospel. This is an indication of that very effectual purposeful call to redemption that comes by the sovereign will of God. We are the called. It's another word, if you will, for **the elect**, for the elect. We are **the chosen**. The Bible says *chosen in Him before the foundation of the world*; a tremendous truth. We are the called, called by God, the elect.

Steven Cole: (:5-7) Big Idea: **God saves us and gives us spiritual gifts so that we will be His channels for the gospel to go to the nations.**

1. God saves us by His grace and gives us gifts to be used in His service.
2. God saves us and gives us gifts to bring about the obedience of faith in others.
3. God saves us and gives us gifts to take the gospel to the nations (Gentiles).
4. God saves us and gives us gifts to bring glory to the name of Jesus Christ.
5. God's saving us and giving us gifts is based on His calling us and setting His love on us.

V. (:7a) **SOURCED IN GOD'S LOVE – RECIPIENTS OF THE EPISTLE**

"to all who are beloved of God in Rome"

John Harvey: Paul adds two appositives to describe the recipients.

- *beloved of God*
- *called as saints*

VI. (:7b) CHARACTERIZED BY HOLINESS

"called as saints"

Frank Thielman: The Roman Christians are “called to be holy.” God also constituted Israel to be “a holy nation” (ἔθνος ἅγιον; **Exod 19:6** LXX), and urged them in the Mosaic law, “You shall be sanctified [ἁγιασθήσεσθε], and you shall be holy [ἅγιοι], for I am holy [ἅγιος], I the Lord your God” (**Lev 11:44** LXX; cf. **19:2**). To be “holy” in such contexts meant to be separate from other peoples. “You shall be holy [ἅγιοι] to me, for I the Lord your God am holy [ἅγιος], who has separated [ἀφορίσας] you from all the nations to be mine” (**Lev 20:26** LXX). This separation was both something that God accomplished at his own initiative and something that required a distinctive way of life described for God’s people in the Mosaic law. Israel’s holiness was both a reality created by God and a summons given by God to his people. The Roman Christians too have been set apart at God’s initiative to live in a way that separates them from other people.

John Murray: The use of the word “called” in this connection is significant. Paul had previously drawn attention to the fact that it was by divine call that he had been invested with the apostolic office (**vs. 1**). Now we are advised that it was by the same kind of action that the believers at Rome were constituted the disciples of Christ.

Michael Gorman: The same God has called the Roman believers (**1:6–7**) to be “beloved” (children) and set them apart to be “saints,” or, better, “his holy people” (NIV) who “belong to Jesus Christ.” To be holy is to be marked out for God’s purposes; it is to be part of an alternative culture, a different way of being human: in the world but not of the world. Paul will have much more to say about this holiness in **chapter 6** and especially **chapters 12–15**. (What he says needs to be heard by contemporary Christians who, in the words of Jesus in **Rev 3:16**, are sometimes more “lukewarm” than they are holy.)

The word “saints,” then, does not refer to a special class of people but to **all who belong to Christ:** God’s *holy ones* (Gk. *hagioi*). Holiness with respect to humans is the scriptural language of covenant relationship, now reconfigured around Jesus, who makes a new covenant possible. The children of Israel were called to be holy because God is holy (**Lev 11:45; 19:2; 20:26**). So also Christians are called to be holy, sharing in the holiness of God by being reshaped into the image of Christ, God’s son and our elder brother (**Rom 8:14–17, 29**).

VII. (:7c) DEPENDENT ON GOD’S RESOURCES – GREETING OF THE EPISTLE

“Grace to you and peace from God our Father and the Lord Jesus Christ.”

Continual supply of grace & peace

John Toews: Paul combines his distinctive theological term “grace” with the Hebrew *peace* greeting to form his own religious greeting.

* * * * *

DEVOTIONAL QUESTIONS:

- 1) What **themes** of the book of Romans are introduced in these opening verses?
- 2) How would Jewish believers and Gentile believers connect (with different areas of emphasis) with Paul's introduction to his epistle?
- 3) What does it mean to you to be "*called*" by God?
- 4) How can you enhance your gospel presentation to focus more on the person of Jesus Christ?

* * * * *

QUOTES FOR REFLECTION:

David Jeremiah: As we begin this study, let's consider why the letter of Romans is important to us today. First, there is an **intellectual reason**. In Romans, the apostle tackles many of the deepest issues of Christian thought and challenges our thinking. Not only does every sentence in Romans overflow with meaning, but in some places even a single word may suggest a profound idea. We can't study the letter to the Romans casually. We have to study it intentionally.

Second, there is a **doctrinal reason** for studying Romans. In almost every chapter, Paul engages in some major doctrinal discussion. And he doesn't waste any time getting into his comprehensive teaching about the gospel—he starts right in the first chapter by tackling the doctrines of the resurrection, Christ's deity, Christ's humanity, faith, and divine judgment.

Third, there is a **spiritual reason**. With the words of Paul's letter, we learn the reality of sin and its destructive consequences. We discover what it means to be redeemed and to be related to God. We uncover how to be filled with and controlled by the power of the Holy Spirit. Romans shows us how to live a life of loyalty, love, and obedience to Jesus Christ.

Fourth, there is a **practical reason** for studying Romans. If we truly know in our hearts and minds what Paul teaches in this short letter, we won't get caught up in misleading doctrine or teachings. The truth we find in Romans enables us to instantly recognize something that doesn't fit with that truth—and compels us to share what we've discovered with others. The teachings we find in Romans thus provide us with a great place to build our understanding of the truth so we can share it unashamedly with others.

Michael Bird: The goal of Paul's apostolic vocation and the purpose of Jesus' advent to Israel were to make the promises of the Abrahamic covenant a reality by drawing immoral, idol-worshipping, pork-eating Gentiles into faith, obedience, and worship toward the names of God and Jesus. The story of salvation in Romans with its polyphonic symphony of movements about Adam, Christ, Israel, wrath, justice, justification, and reconciliation lead to a redeemed humanity, a restored Israel, and a renewed creation, and these turn out to be the stunning means

of the glorification of God the Father and the Lord Jesus Christ (see **Rom 11:33 – 36; 15:6; 16:27**). . .

According to [Paul], Christology is about contemplating the person and work of Christ known to us through the “*gospel of Christ*” (**Rom 15:19; 1 Cor 9:12; 2 Cor 2:12; 9:13; 10:14; Gal 1:7; Phil 1:27; 1 Thess 3:2**). Christian ethics requires living a life “*worthy of the gospel*” (**Phil 1:27**). A study of salvation prods us to unpack the polyphonic richness of the gospel of salvation (**Rom 1:16; Eph 1:13**). Apologetics is our attempt to offer a “*defense of the gospel*” (**Phil 1:16**). A church is in essence a community of the gospelized. The sacraments are a means of grace communicated through the symbols of the gospel: baptism and Lord’s Supper. Mission is the church’s strategy to “*advance the gospel*” (**Phil 1:12**). Every sub-branch of Christian theology is indelibly connected to the gospel like branches drawing nutrients from a vine. Peter Jensen is bang on target when he writes:

“The gospel stands at the beginning of the story that explains why there are Christians at all, on the boundary between belief and unbelief — often, for the hearer, prior to a knowledge of the Bible itself. For the person entering from the outside, the gospel is the introduction to the faith, the starting-point for understanding. It then rightly becomes the touchstone of the faith. Since this is where faith begins, it is essential that faith continues to conform to it.”

Michael Gorman: Summary

The importance of these first few lines of the letter, with their brief but poignant summary of the gospel, should not be underestimated. The emphasis is on Jesus’ royalty and resurrection. In conjunction with **1:16–17**, which focuses on God’s righteousness, they tell us in summary form what the gospel is and what it does. References to Jesus as Son of God and Messiah (Christ) mean that he is the prophetically promised king who has inaugurated God’s salvation, righteousness, and justice in the world.

Such claims are implicitly a challenge to Rome, with its own claims to being the good news of universal sovereignty, salvation, and justice, embodied especially in its own royal figure, the emperor. Such claims about Jesus also implicitly invite Paul’s audience to participate in the universal dissemination of God’s gospel as the truly good news humanity needs and the proper alternative to any other alleged gospel of salvation, ancient or contemporary.

Having identified himself, the content of the gospel, and his letter’s recipients, Paul offers the Romans grace and peace (1:7b). In these first seven verses, then, Paul lets his addressees know that they and he—despite their different callings—share a common gospel experience of grace and a common response of believing allegiance that relates them to God the Father, Jesus the Messiah/Son and Lord, and the Spirit of holiness. The stage is set for Paul to narrate the saving work of the triune God and the human joy of benefiting from and participating in that salvation.⁷ But first, Paul needs to create a more personal rapport with his addressees, which he does in the following verses.

Leedy Greek NT Diagrams:

Rom 1:1-7

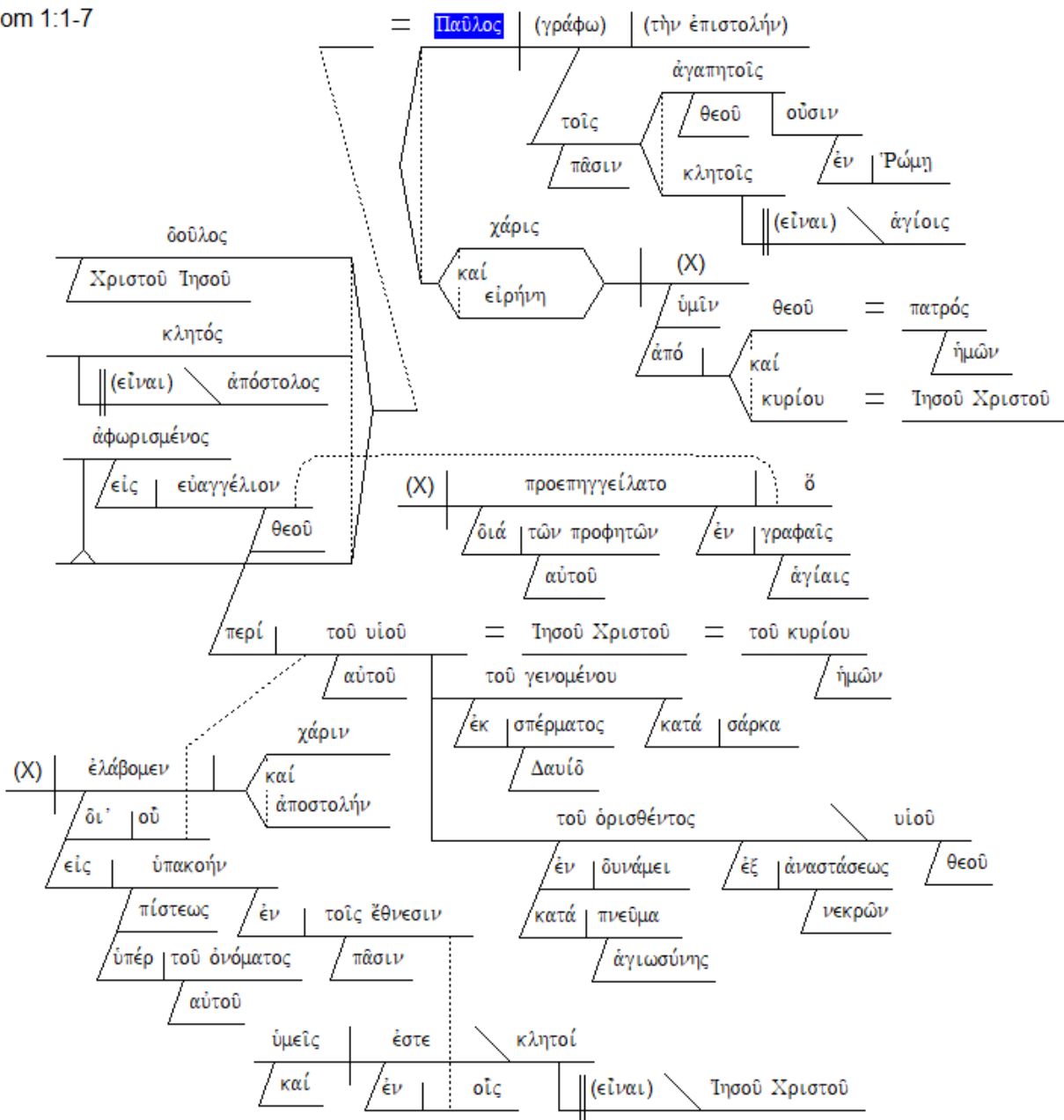

Frank Thielman:

Romans 1:1-7

- 1a Sender **Paul,**
b Description slave
c Possession of Christ Jesus,
- d Description called
e Purpose to be an apostle,
- f Description set apart
g Purpose for the gospel of God,
2a Time which he promised beforehand
b Agency through his prophets
c Place in the holy Scriptures

- 3a Reference concerning his Son,
b Expansion who was born from David's offspring
c Reference according to the flesh
- 4a Expansion who was appointed Son of God in power
b Reference according to the Spirit of holiness
c Time from the resurrection of the dead,
- d Apposition Jesus Christ our Lord,
5a Agency through whom we received grace and apostleship
b Purpose for the obedience of faith
c Place among all the gentiles
- d Purpose on behalf of his name
6a Association among whom you are also called
b Agency by Christ Jesus.

- 7a Recipients **To all who are in Rome,**
b Description dearly loved
c Agency by God,
- d Description called
e Purpose to be holy,
- f Greeting **grace to you and**
 peace
g Source from God our Father and the Lord Jesus Christ.

TEXT: ROMANS 1:8-15

TITLE: FULFILLING GOD'S CALLING

BIG IDEA:

FULFILLING GOD'S CALLING COMPELS US TO REACH OUT TO OTHERS TO PRODUCE ABUNDANT GOSPEL FRUIT

INTRODUCTION:

Michael Gorman: Paul does three main things in this particular thanksgiving, all of which help to establish his relationship with the Roman faithful. He speaks of **gratitude, prayer, and hope** rooted in a sense of **Christian mutuality**. . . Prayer has been Paul's substitute for presence thus far in his relationship with the Roman house churches. Now that intercession will be supplemented with a letter as a prelude to an anticipated visit. With these words of introduction, gratitude, and explanation written, Paul proceeds to "*proclaim the gospel*" to those in Rome.

Michael Bird: The background story here is that Paul sees himself as playing a key role in God's plan to extend his salvation to the ends of the earth. Just as Isaiah looked ahead to a time when the returnees from exile would be sent abroad as ensigns to the nations, going as far as Greece, Libya, and Spain (see **Isa 66:19 – 20**), in a similar way, Paul may have envisioned his apostolic ministry as taking the shape of an arc that went from Jerusalem to northern Greece to Rome to Spain; then, who knows, perhaps back along the North African coast and finally to Egypt and home to Jerusalem (see **Rom 15:17 – 24**). Just as the Psalter called Israel to sing God's praises among the nations and make them seek out God's blessings (see **Pss 57:9; 67:2 – 4; 96:10**), so too Paul believed that he was sent out to the Greeks and barbarians of the world with the good news that God would bless them in Israel's Messiah. Paul was driven by the fact that in the Bible he read that God intended to make Abraham the father of many nations (see **Rom 4:17 – 18**). God's salvation reaches out to the world through the revelation of God's righteousness in the gospel, a righteousness that proves God's faithfulness to Israel and brings mercy to the nations (see **Ps 98:1 – 3**).

Douglas Moo: Paul continues to adapt the ancient letter form to his own purposes. Letters often featured an expression of thanks to the gods in the "proem," the second main part of a letter. Paul gives thanks to God for the Roman Christians and assures them that he often prays for them. He uses his petition for his own ministry among them as a transition to a brief description of his plans and motivations. The section is marked by a certain hesitation and deference on Paul's part, as he seeks to avoid "lording it over" these Christians whom he did not convert and has never visited. He writes diplomatically in an effort to win a hearing for his presentation of the gospel.

R. Kent Hughes: vv. **8-17** -- Paul describes what is behind his own burning **motivation** to minister at Rome. They encourage us to go for it! In **verses 8–10** Paul writes that he had heard of the Romans' faith and its widespread fame. This prompted him to make unceasing requests to visit the Christians in Rome.

In **verses 11–17** he gets down to the specifics of his motivation.

- First (in **verses 11–13**), there is the motivation that springs from the prospect of mutual encouragement.
- Second, in **verses 14, 15** there is the motivation that comes from a sense of obligation.
- Third (**vv. 16, 17**), there is the motivation that grows from his confidence in the power of the gospel.

As we examine these, we will see that they intensify so that the final motivation (his confidence in the gospel’s power) is by far the supreme driving force behind his ministry. As we examine this text, we need to keep in the back of our minds that everyone can enlarge his or her spiritual vision by internalizing the elements of Paul’s motivation to minister to Rome.

I. (:8) THE EVIDENCE OF GOSPEL FRUIT EVOKES THANKSGIVING

A. Priority of Thanksgiving to God

“First, I thank my God through Jesus Christ for you all,”

James Dunn: The *μου* (“my God”) does not, of course, signify “mine and not yours”; it is simply a way of stressing the fervor of his devotion, his deep personal commitment (so **Phil 1:3; Philem 4**; used regularly in the **Pss—3:7; 5:2; 7:1, 3, 6; 13:3; 18:2, 6, 21, 28–29; 22:1–2, 10**; etc.).

Douglas Moo: Paul’s thanksgiving is expressed to “my God” and is mediated “*through Jesus Christ.*” Christ has created the access to God that enables Paul to approach him in thanksgiving.

B. Proclamation of Faith Worldwide

“because your faith is being proclaimed throughout the whole world.”

Michael Bird: The early church seemed to have possessed a clear awareness of being a **worldwide network**. The first Christians did not, despite all of their diversity, see themselves as isolated and introspective congregations each keeping to their own. On the contrary, there was what **Michael Thompson** called a “Holy Internet,” with believers travelling widely, visiting each other, writing to one another, and sharing each other’s literature.

Frank Thielman: Paul enjoyed both hearing and passing along reports of the faithfulness of believers in various parts of the world because these reports encouraged other believers by providing examples for them to follow (**2 Cor 8:1–5; 9:1–4; 1 Thess 1:6–8; 2 Thess 1:3–4**) and by providing a reason to praise God (**2 Cor 9:11–14**). Paul believed that other Christians took encouragement from the knowledge that even in Rome, the greatest city in the world as they knew it, there existed a vibrant community of people who had believed the gospel. This is why he thanks God.

II. (:9-12) THE PROSPECT OF ABUNDANT GOSPEL FRUIT MOTIVATES US TO REACH OUT TO OTHERS

A. (:9-10) Reaching out in Concerned Prayer

1. (:9) Regular Pattern of Concerned Intercession and Thanksgiving

a. Referencing God as Corroborating Witness

*“For God,
whom I serve in my spirit in the preaching of the gospel of His Son,
is my witness”*

James Dunn: This is one of the relatively few instances where Paul uses πνεῦμα for the **human spirit** (see also particularly **8:16; 1 Cor 5:3–5; 16:18; 2 Cor 2:13; Gal 6:18; Phil 4:23; 1 Thess 5:23; Philem 25**), referring to that part, or better, dimension of the person by which he/she is related to God (cf. particularly **8:16; 1 Cor 2:10–13**). That it is thus through the human spirit that the Spirit of God acts upon and communicates with the human being results in some experiential ambiguity (**1 Cor 14:14, 32; 2 Cor 4:13**; and cf. **Rom 1:9** with **Phil 3:3**; elsewhere, e.g., **Mark 14:38; James 4:5**);

John Toews: Paul introduces God as a witness that he regularly intercedes for the churches in Rome. Unable to prove it from a distance, Paul invokes God to underline his deep concern.

John Murray: Why does Paul use an **oath** in this instance? It is for the purpose of assuring the Roman believers of his intense interest in them and concern for them and, more specifically, to certify by the most solemn kind of sanction that his failure hitherto to visit Rome was not due to any lack of desire or purpose to that effect but was due to providential interference which he later on mentions (**vs. 13; 15:22-25**). This shows the solicitude on Paul’s part to remove all possible misunderstanding respecting the delay in visiting Rome and his concern to establish in the minds of the saints there the full assurance of the bond of affection and esteem by which he was united to them lest any contrary suspicion would interfere with the response which his apostolic epistle should receive at their hands.

b. Testifying to Persevering Prayer

“as to how unceasingly I make mention of you,”

Michael Bird: Paul routinely reminded his audiences of the constancy of his prayers for them (**1 Cor 1:4; Eph 1:16; Phil 1:4; Col 1:3; 1 Thess 1:2; 2 Thess 1:3; Phlm 4**) and how he regularly makes petitions for their growth in the faith (**Eph 1:16 – 19; Phil 1:9 – 11; Col 1:9 – 11; Phlm 6**). These prayers are windows into the theocentric piety, Christ-centered devotion, and pastoral heart of the apostle.

F. F. Bruce: That Paul should pray regularly for his own converts is what we might expect, but it is evident from this passage that his prayers went beyond his immediate circle of personal acquaintance and apostolic responsibility.

2. (:10) Request for a Face-to-Face Visit

a. Ongoing Desire

“always in my prayers making request,”

- b. Overcoming Obstacles and Delays In Accordance with God's Will
*"if perhaps now at last by the will of God
I may succeed in coming to you."*

James Dunn: The piling up of adverbs indicates his concern not to be misunderstood. The more he stresses that his desire to visit the Roman congregations is of long standing, the more he is open to criticism for not coming sooner. Hence the equal stress on divine initiative; the slave cannot order his life in accordance with his own wishes (so also v 13).

Michael Bird: Whatever obstacles had hitherto prevented Paul from coming to Rome, Paul now thinks that they are sufficiently cleared out of the way as to enable him to head to Spain via Rome. Sadly, the events narrated in **Acts 21:28** show that Paul had no idea about the many misfortunes that were about to befall him and would yet hinder his missionary plans. He would make it to Rome several years later only after first being mobbed, arrested, enduring a lengthy imprisonment and trial, and surviving a shipwreck!

Frank Thielman: The word Paul uses for "asking" (δεόμαι) means to plead for something and has an air of **urgency** about it (e.g., **Ps 29:9 LXX [30:8 Eng.; 30:9 Heb.]; Isa 37:4 LXX; Jdt 8:31; Acts 8:22, 24**), especially when combined with the emphatic expression "if . . . somehow, at last" (εἴ πως ἤδη ποτέ). Paul was communicating to the Romans the great strength of his desire to visit them. As the prayers themselves show, if this is to happen God must remove any hindrances, including the hindrance of further work for Paul in the region stretching from Jerusalem to Illyricum, work that up to this point took priority over Paul's own desire of many years to visit Rome (**15:19, 22–23**). So, if Paul is to visit Rome, it must be the will of God (cf. **15:32**).

B. (:11-12) Reaching out in Personal Ministry

1. (:11a) Passion for Face-to-Face Visit

"For I long to see you"

2. (:11-12) Purpose of Face-to-Face Visit

a. (:11) Edification of the Believers in Rome

*"in order that I may impart some spiritual gift to you,
that you may be established;"*

Frank Thielman: This is the only one of Paul's six uses of the verb that is in the **passive voice** ("be strengthened" [στηριχθῆναι]), something that most translations miss but is nicely preserved in the NAB ("so that you may be strengthened"). The passive contributes to the **deferential tone** of the passage, slightly diminishing the role of Paul himself and leading to the next thought in which Paul clarifies what he says to remove any misunderstanding that only the Romans and not Paul himself will benefit spiritually from his visit.

b. (:12) Encouragement Mutually

*"that is, that I may be encouraged together with you while among
you, each of us by the other's faith, both yours and mine."*

Frank Thielman: He communicates his desire for mutual encouragement in three ways.

- First, he affixes to his characteristic term “*encourage*” (παρακαλέω) a preposition that means “*together with*” (σύν) to show that he will experience encouragement together with them.
- Second, he says that their faith will be an encouragement to “*one another*” (ἀλλήλοις).
- Third, the conjunction he uses to join “*yours*” (ὑμῶν) and “*mine*” (ἐμοῦ) “serves to unite complements” and so emphasizes the equity between the two parties: he will be encouraged by their faith just as their faith will be encouraged by his.

Steven Tackett: In the Gospel of John, the Lord says that the Holy Spirit, the Holy Ghost, is a Comforter, but what does the Holy Spirit use to bring comfort? He uses the **Scriptures** as His number one source of comfort. Look at **Romans 15:4**: “*For whatsoever things were written aforetime were written for our learning, that we through patience and comfort of the scriptures might have hope.*” The ministry of the Holy Spirit is to bring comfort and the way He brings comfort is through the Word of God. Our comfort is through the hope we receive from the Scriptures. Paul wants to be comforted from the Scriptures together with the believers in Rome by their mutual faith in the Gospel of Grace. Another way the Holy Ghost brings comfort is through the fellowship of other like-minded believers. The encouragement, admonishment, and sharing one receives from other believers is another way the Holy Spirit works today.

Timothy Keller: **Verse 11** teaches us to use whatever gifts the Lord has graciously given us to make others stronger in their faith. **Verse 12** teaches us to allow others to use the faith and gifts the Lord has given them to build us up. We should never leave our church meetings, having spent time surrounded by beloved, distinctive people of faith, without feeling encouraged!

III. (:13-15) THE OBLIGATION OF GOD’S CALLING COMPELS US TO REACH OUT TO OTHERS

John Harvey: Paul’s Planned Visit to Rome (1:13–15)

1. Paul’s intention to visit (**1:13**)
 - a. Often planned
 - b. Circumstantially hindered
 - c. With an eye to fruit
2. Paul’s reason to visit (**1:14–15**)
 - a. Obligated to all humankind
 - b. Eager to preach the gospel

A. (:13) The Compulsion to Minister in Rome

1. Previous Plans to Come to Rome

“And I do not want you to be unaware, brethren, that often I have planned to come to you (and have been prevented thus far)”

James Dunn: Rome, the capital of such a mighty empire, Rome, to which all roads led, would naturally be a magnet for Paul. In his strategy for the universal outreach of the gospel (**1:5**—“*all the nations*”), he must often have considered the importance of a strong Christian grouping there

and the desirability of his linking up personally with it. What it was which “*prevented*” him, he does not say, nor when he repeats the claim in **15:22**. It is certainly possible that he thought the repeated hindrances were of demonic/Satanic origin (as in **1 Thess 2:18**); and the expulsion of Jews from Rome by Claudius in 49 would certainly have provided a strong disincentive. But with someone like Paul, who threw himself so unreservedly into his work, it might simply be that ever fresh opportunities and the particular problems of his already established churches, not to mention the organization of the collection (**15:22–29**), made unceasing demands on his time which he could not easily ignore.

2. Pastoral Purpose in Coming to Rome

“in order that I might obtain some fruit among you also, even as among the rest of the Gentiles.”

Frank Thielman: Paul qualifies this desire [to visit Rome] in three ways.

- First, he corrects any notion that he thinks his visit to Rome will be one sided—they will encourage him just as he will encourage them in the faith (**1:12**).
- Second, he makes clear that he would have visited them earlier, but God hindered him from doing so (**1:13**).
- Third, he explains that his strong desire to visit Rome arises from his conviction that the gospel cuts across the humanly imposed social barriers of culture and education (**1:14**).

B. (:14) The Obligation of God’s Calling Extends to All Men without Partiality

1. Burden of Paul’s Ministry Obligation

“I am under obligation”

Timothy Keller: Paul is “*obligated*” to everyone, everywhere. God has shared the gospel with him. But God has also commissioned him to declare it to others. So Paul **owes** people the gospel.

2. Scope of Paul’s Ministry Obligation

a. Regardless of Level of Culture

“both to Greeks and to barbarians,”

John Toews: The object of the obligation embraces the entire Gentile world. Both pairs, Greeks and barbarians and also wise and mindless (JET), represent a Greek perspective on the categories of humanity. “*Greek and barbarian*” differentiates those Gentiles who possess Greco-Roman culture and the rest of the Gentiles, especially Orientals, which would include Jews. “*Wise and also mindless*” is an explanation of “*Greek and barbarian*”; it distinguishes those who are intelligent and educated from those who are not. In Rome this ethnocentric division of humanity was directed especially against immigrating “barbarians” from the Orient, which would include Jews and Jewish Christians returning to the city following the expiration of Claudius’ edict of expulsion. Paul’s apostolic obligation relativizes all cultural barriers between people. As an apostle of Messiah Jesus Paul crosses the conventions and prejudices that divide the world.

b. Regardless of Level of Sophistication and Insight

“both to the wise and to the foolish.”

James Dunn: These are the categories of self-conscious Hellenism rather than the words most natural to a Jew. For the Hellenist, conscious of rich cultural and intellectual heritage, the world could be categorized into Greeks and all the rest as uncultured barbarians, and society could be divided into those who use their minds and those who do not, intellectuals and nonintellectuals. The significance then is that Paul, in elaborating his sense of call to evangelize the Gentiles, deliberately looks at the world through the eyes of a Gentile, from the perspective of sophisticated Hellenism. His commission as apostle to the Gentiles embraces all races, both those whom Hellenism owns and those it despises, and all levels of society, both those highly regarded within Hellenism and those disregarded. The obligation laid upon him in his commissioning by the risen Christ was to take the gospel to all Gentiles without regard to Gentile distinctions of race and status.

Frank Thielman: The gospel, Paul says, is for everyone: gentiles, Greeks, barbarians, sophisticated, foolish, and Jew (1:14–16). People from all these groups and more lived in Rome, and the gospel collapsed the barriers between all of them. Some of these barriers had made their way into the Roman church (11:18; 12:3; 14:1–15:7; cf. 16:17), and Paul believed that God had called him to proclaim the gospel in Rome in such a way that its implications for their dissolution became evident (11:13; 15:15).

Frank Thielman: For any upper-class Roman among Paul's first readers, the thought of the apostle being under some "obligation" to **barbarians** must have seemed absurd. Barbarians were obligated to serve the Romans as slaves, as their ill breeding dictated. For Paul, however, the gospel cut through all this and **leveled the social landscape**. The gospel insisted that all humanity stood before God on equal terms: all had rebelled against him (1:18–3:20) and all received the free offer of a right standing and relationship with him through the atoning death of Christ (3:21–4:25; cf. Gal 3:28; Col 3:11). Paul's apostolic commission was to preach this gospel, and so he was under obligation to all.

C. (:15) The Proper Response is 100% Eagerness to Fulfill God's Calling

"Thus, for my part, I am eager to preach the gospel to you also who are in Rome."

James Stifler: In accordance with this acknowledged obligation Paul declares his readiness to preach at Rome. He is master of his purpose, but not of his circumstances.

James Dunn: It is simply that if any one verb sums up his lifelong obligation it is this one—"to preach the gospel"—so that its use can embrace the **whole range of his ministry**, including his explication of the gospel, as in this very letter. Certainly it is the case that Paul elsewhere uses εὐαγγελίζεσθαι in the sense of "evangelize," a preaching which aims for conversion (10:15; 15:20; 1 Cor 1:17; 9:16, 18; 15:1, 2; 2 Cor 10:16; 11:7; Gal 1:8, 9, 11, 16, 23; 4:13; so also Eph 2:17; 3:8; 1 Pet 1:12, 25; and regularly in Acts). But Paul did not confine his apostolic "set-apartness to the gospel" (1:1) or "service in the gospel" (1:9) to "first time" preaching of the gospel, or restrict the gospel simply to the initial impulse on the way to salvation (1:16), and 1 Thess 3:6 is sufficient evidence that his use of εὐαγγελίζεσθαι was not narrowly fixed (against Zeller, *Juden*, 55–58).

Douglas Moo: Paul has been given a commission from the Lord to be “*apostle to the Gentiles,*” and it is this divine mandate, not any personal benefit or emotional satisfaction or marketing strategy, that impels Paul to travel ever farther afield.

Transition to next section: The only thing that would hold us back is lack of confidence in the gospel.

* * * * *

DEVOTIONAL QUESTIONS:

- 1) Why do so many Christian leaders (so consumed with ministering to others) have difficulty allowing others to minister to them and encourage them?
- 2) Do you have the type of eagerness to minister to others that Paul expresses here?
- 3) How constant are your prayers for the spiritual growth of other believers?
- 4) What type of reputation does your local church have in the community?

* * * * *

QUOTES FOR REFLECTION:

Thomas Schreiner: What is the connection between **verses 8–15** and **verses 1–7**? Often there is little discussion as to how this paragraph advances the argument from **verses 1–7**. The individual verses may be analyzed while neglecting the overall contribution of this paragraph to the progression of thought. In **verses 1–7** Paul stresses that he was called as an apostle to preach the gospel to the gentiles. More specifically, the believers in Rome (**vv. 6–7**) are included among the gentiles over whom Paul has apostolic oversight. The Pauline thanksgiving and prayer in **verses 8–15** are an expression of this apostolic commission with reference to the church at Rome. The thanksgiving for the spread of the gospel in Rome is not merely a private thanksgiving by an individual. As an apostle to the gentiles, Paul voices thanks that the gospel is bearing fruit among the gentiles in Rome. In the same way the prayer for the Romans is an **extension of Paul’s apostleship**. This is confirmed by the specific content of the prayer, for the only petition mentioned is his desire to visit Rome. A Pauline visit is not merely a private affair. He would come as an emissary of Christ to strengthen them (**v. 11**) and to obtain fruit as he did among other gentiles (**v. 13**). Paul felt that he had an apostolic obligation to preach the gospel to all gentiles (**v. 14**), which includes those residing in Rome (**v. 15**), and we shouldn’t fail to notice that the gospel is proclaimed in the letter itself.

James Dunn: Paul’s language reads rather as though he had expressed his desire to visit Rome on more than one occasion, but had never carried the intention through, and consequently had exposed himself to some criticism for his lack of good faith or lack of resolute purpose (cf. **2 Cor 1–2**). Hence not only the oath, but also the awkwardness of the phrasing in **v 10**, the

repeated assurance of his earnest desire to see them at the beginning of v 11, the yet further and somewhat labored reassurance of v 13 with its explanation of his having been prevented despite his best and often reaffirmed intention, and the final assurance of v 15. This continued consciousness of vulnerability to criticism and sensitivity to (likely) actual criticism, in a letter to unfamiliar congregations, is a reminder of how exposed Paul's position must have been within the earliest expansion of Christianity.

Douglas Moo: Few of us will have such clear direction about a call to ministry or about the direction our ministry should take. But the **imperative to evangelize** is an obligation, Paul suggests, that all believers share. In **1 Corinthians 3–4**, he describes his dedication to the task of evangelism (**3:3–15**), a task that brought him much personal hardship (**4:8–13**). He concludes with a call to the Corinthians to imitate him (**4:16**). Similarly in 2 Corinthians Paul asserts that, knowing the fear of the Lord, he tries to persuade people to follow Christ (**2 Cor. 5:11**). And the reason for his commitment? “*Christ’s love compels us*” (**5:14**). Contemplation of the benefits won for us by Christ should motivate all of us to seek to share these benefits with others.

But another motivation also appears regularly in Paul's discussion of his ministry: the enhancement of God's name and glory. We have seen such a concern already in Romans, as Paul claimed that his apostolic work was “*for his [Jesus Christ’s] name’s sake*” (**1:5**). In a climactic section of Romans, Paul announces that the inclusion of Gentiles within the people of God is so that they “*may glorify God for his mercy*” (**15:9**; see also **15:16**; **2 Cor. 4:15**; **Phil. 1:11**). Paul's evangelism, his letters suggest, has two great motivations: a sense of **obligation** derived from what God has done for him and commissioned him to do for others, and a **desire that God will be glorified** by as great a number of people as possible. We are to imitate Paul by extending God's grace in the gospel just as he did.

John Toews: Running through “the thanksgiving” and “disclosure formula” and into the “thesis statement” is a **pattern of argument** designed to embrace the Roman Christians. Three times Paul asserts his desire to visit Rome and each time he gives the reasons for these intentions.

Vv. 9-10 Intention—Paul's prayer to visit Rome

Vv. 11-12 Reason—to impart a spiritual gift, to be strengthened

Vv. 13a Intention—Paul's long-standing desire to visit Rome

Vv. 13b-14 Reason—to reap some harvest among the Gentiles

V. 15 Intention—Paul's long-standing eagerness

Vv. 16-18 Reason—the power of the gospel

The whole letter is framed by a formal structure (**chiastic**) that is designed to create a positive environment for hearing Paul:

A **1:8** Paul gives thanks for the Romans' faith

B **1:9** Paul's prayer for the Romans

C **1:10-11** Paul's desire to visit Rome

D **1:13** Paul prevented from visiting Rome

E **1:14-15** Paul's mission to the Gentiles

E 15:14-16 Paul's mission to the Gentiles

D 15:17-22 Paul hindered from visiting Rome

C 15:23-29 Paul will go to Rome after Jerusalem

B 15:30-32 Paul exhorts prayer for him

A 15:33 Paul invokes peace for the Romans

The parallelism between **1:1-15** and **15:14-33** reflects a deliberate composition. Paul wraps his pastoral concerns for the unity of Jews and Gentiles under the righteousness of God in the context of his apostolic presence.

Leedy Greek NT Diagrams

Rom 1:8

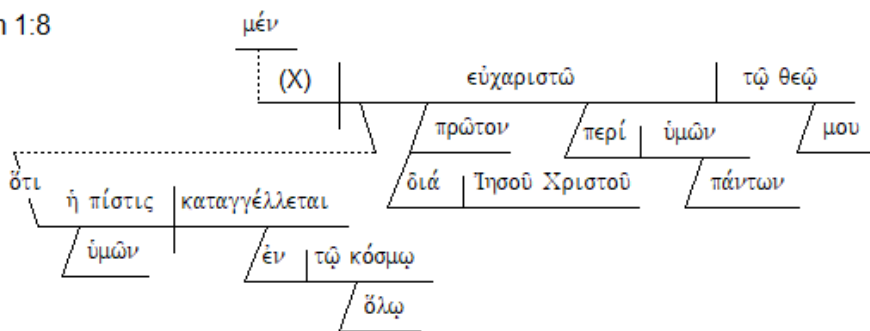

Rom 1:9-10

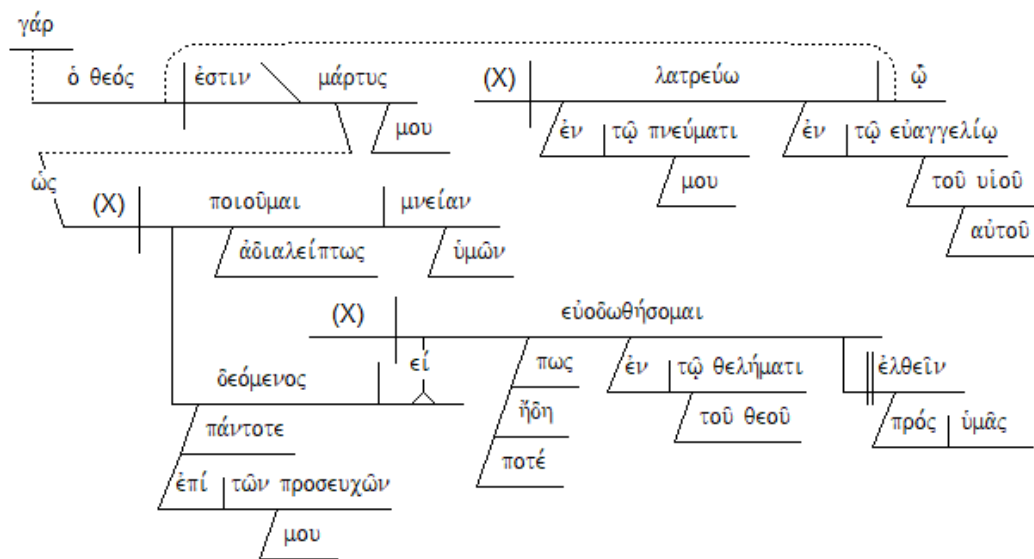

Rom 1:11-12

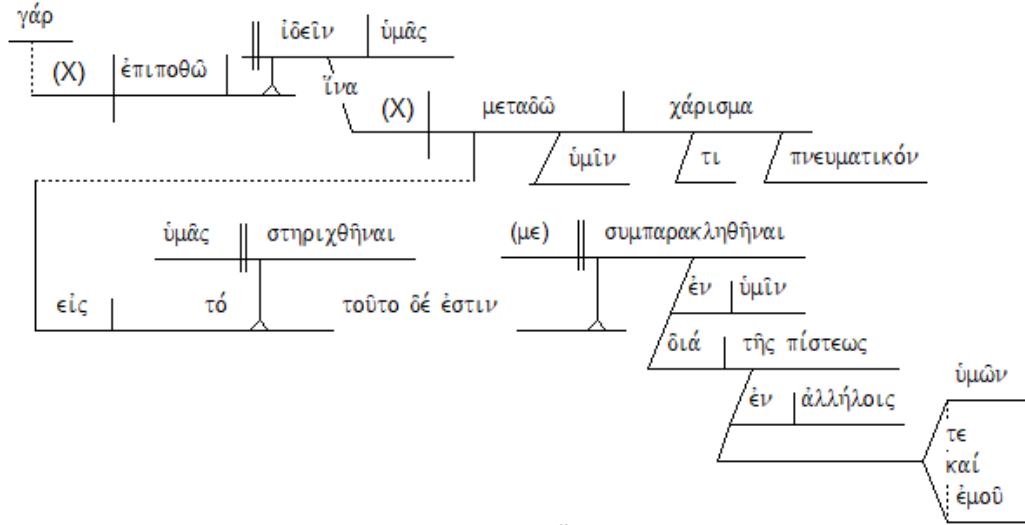

Rom 1:13

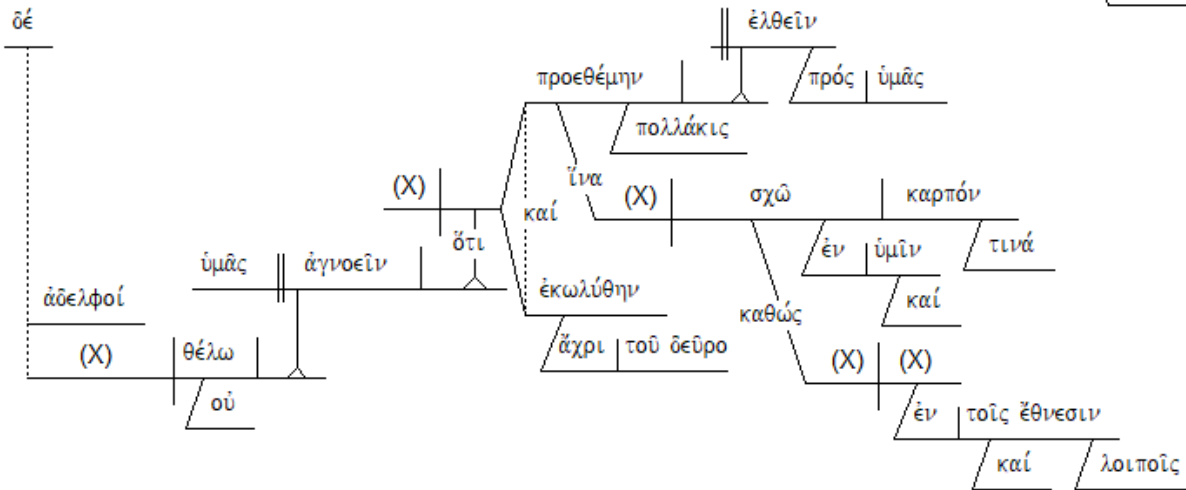

Rom 1:14-15

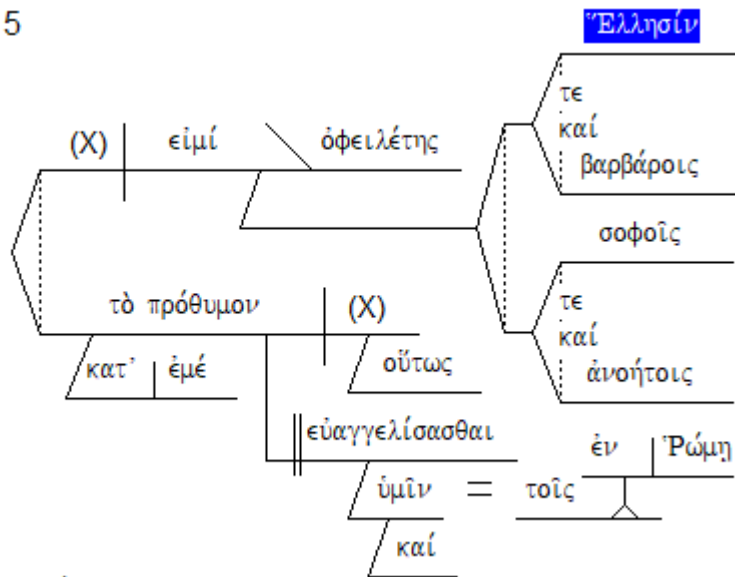

Frank Thielman:

8a Assertion b Means c Reference d Cause	First, I thank my God through Jesus Christ concerning all of you because your faith is proclaimed in the entire world.
9a Oath b Relationship c Sphere d Sphere e Content	For God is my witness whom I serve in my spirit in the gospel of his Son that I make mention of you unceasingly always in my prayers asking if I might succeed in coming to you somehow at last by the will of God.
10a Restatement b Content c Time d Time e Means	
11a Desire b Purpose c Purpose	For I long to see you in order that I might share some spiritual gift with you so that you might be strengthened that is, more precisely, to be encouraged together with you through one another's faith both yours and mine.
12a Expansion b Means c Restatement	
13a Assertion b Content c Purpose d Place e Comparison	Now I do not want you to be unaware, brothers and sisters, that I have often planned to come to you (but have been hindered ↺ until now) in order that I might have some fruit among you also just as [I] also [have] among the rest ↺ of the gentiles.
14a Assertion b Reference c Contrast d Reference e Contrast	I am a debtor to Greeks and to barbarians, to the sophisticated and to the foolish,
15a Result b Place	hence my eagerness, as far as depends on me, to proclaim the gospel also to you who are in Rome.

TEXT: ROMANS 1:16-17

TITLE: *THEME VERSES: BOASTING IN GOSPEL CLOUT*

BIG IDEA:

THE EFFICACY OF THE GOSPEL INSPIRES BOLDNESS IN PROCLAMATION

INTRODUCTION:

Are you ashamed of the gospel or do you boast in the gospel?
(overcomes our feelings of reluctance and inadequacy)

James Boice: [These verses] are the most important in the letter and perhaps in all literature. They are the theme of this epistle and the essence of Christianity.

Thomas Schreiner: The argument can be displayed as follows:

Paul is eager to preach the gospel in Rome (**15**).

Because (γάρ) he is not ashamed of the gospel (**16a**).

He is not ashamed of the gospel because (γάρ) it is the power of God bringing salvation to all who believe (**16b**).

The gospel is the saving power of God because (γάρ) the righteousness of God (i.e., his saving righteousness) is revealed in it by faith (**17a**).

This understanding of the righteousness of God is supported by the OT (καθώς), which says that the righteous will live (i.e., enjoy eternal life) by faith (**17b**).

Thus even though **verses 16–17** are grammatically subordinate to **verse 15**, the **thematic centrality** of **verses 16–17** is evident, since the desire to preach is intertwined with what is preached. The centrality of **verses 16–17** is apparent, since the reference to the εὐαγγέλιον (*euangelion*, gospel) in **verse 16** forms a bridge with **verses 1, 9, and 15**, where Paul emphasizes that his apostolic calling is in service to the gospel. To say that the righteousness of God alone is the theme of the letter is insufficient. **Verses 16–17** must be taken together, for the righteousness of God is revealed in the gospel. I summarize the theme as follows: **the gospel is the saving power of God in which the righteousness of God is revealed.**

Timothy Keller: Paul is often fond of contrasting “mere” words with power (see, for instance, **1 Corinthians 4:20**). Paul is saying that the gospel is not merely a concept or a philosophy. In the gospel, words and power come together. The message of the gospel is what God has done and will do for us. Paul says that the gospel is therefore a power. He doesn’t say it brings power or has power, but that **it actually is power**. The gospel message is actually the power of God in verbal, cognitive form. It lifts people up; it transforms and changes things.

Grant Osborne: **Verses 16 and 17** summarize the thrust of the rest of Paul’s letter and give the reason behind Paul’s missionary zeal. Paul was ready, even eager (**1:15**) to preach at Rome. And he was not ashamed of the gospel, even though the gospel was held in contempt by those who

did not believe; even though those who preached it could face humiliation and suffering. Paul was not intimidated by the intellect of Greece nor the power of Rome. When describing to the Corinthians the typical attitudes toward the gospel, Paul wrote, “*we proclaim Christ crucified, a stumbling block to Jews and foolishness to Gentiles,*” (1 Corinthians 1:23 NRSV). Paul was not ashamed, because he knew from experience that the gospel had the power to transform lives, so he was eager to take it to as many as would listen. This verse marks the beginning of Paul’s extended explanation of the gospel. Reading, understanding, and applying the gospel faithfully can also bring us to that point of being unashamed of what God has said and done.

John MacArthur: He is **proud of the gospel**. He is overjoyed at the privilege of proclamation. He is utterly and absolutely eager to preach Jesus Christ. And even though it is a stumbling block to the Jew, and foolishness to the Gentile, the gospel is still the power of God unto salvation to all that believe, and Paul is not hesitant to preach it.

He has been imprisoned in Philippi. He has been chased out of Thessalonica. He has been smuggled from Berea. He was laughed at in Athens. He was seen as a fool in Corinth. He was nothing but an irritant and sore spot in Jerusalem. He was stoned while in Galatia. And yet he will be **eager to preach the gospel** at Rome, also.

Thomas Constable: Verses 16-17 are the key verses in Romans because they state the theme of the revelation that follows. Paul’s message was the gospel. He felt no shame declaring it but was eager to proclaim it because it was a message that can deliver everyone who believes it from God’s wrath. It is a message of how a righteous God righteously makes people righteous. The theme of the gospel is the righteousness of God, and the theme of Romans is the gospel.

TWO REASONS WHY THE GOSPEL INSPIRES BOLDNESS IN PROCLAMATION

I. (:16) BECAUSE THE GOSPEL SAVES – IT IS THE POWER OF GOD UNTO SALVATION TO EVERYONE WHO BELIEVES (BOTH JEW AND GENTILE)

“For I am not ashamed of the gospel, for it is the power of God for salvation to everyone who believes, to the Jew first and also to the Greek.”

Thomas Schreiner: The hesitancy to “*bear witness*” to the gospel was rooted in fear of suffering harm. Paul’s boldness here points to his willingness to confess the gospel in public despite the response from opponents. These are not empty words in Paul’s case, since he has already endured much suffering (2 Cor. 11:23–27).

R. Kent Hughes: Paul is not ashamed of this good news because it is the dynamic, unharnessable power of God to effect salvation and all its temporal and eternal benefits for everyone who believes.

Frank Thielman: Rome was the seat of power and Greco-Roman culture in Paul’s world, and most people derived what power they had from their social connections with people higher up the social, political, or economic ladder. In such a context, the message of the early Christians, with its focus on one who had been crucified and on elements that were common to all humanity

(3:21–26), might appear shameful. Paul is not ashamed of it, however, because (γάρ) through the gospel God has demonstrated his power to bring people “*salvation*” (σωτηρία).

Thomas Constable: Paul's third basic attitude toward the gospel now comes out. Not only did he feel **obligated** (v. 14) and **eager** (v. 15) to proclaim it, but he also felt **unashamed** to do so. This is an example of the figure of speech called **litotes**, in which one sets forth a positive idea (I am proud of the gospel) by expressing its negative opposite (“*I am not ashamed of the gospel*”). The reason for using this figure of speech is to stress the positive idea. The reason for Paul's proud confidence in the gospel was that the gospel message has tremendous power.

William Hendriksen: Are the Romans always boasting about their power, the force by which they have conquered the world? “The gospel I proclaim,” says Paul, as it were, “is superior by far. It has achieved and offers something far better, namely, everlasting salvation, and this not for the people of one particular nation – for example, Rome – but for everyone who exercises faith.”

A. Its Content = Good News (not mixed with any bad)

B. Its Extreme Power When Appropriated by Faith -- we have what people need; it works

Charles Hodge: The faith of which the apostle here speaks includes a firm persuasion of the truth, and a reliance or trust on the object of faith. . . . The exercise, or state of mind expressed by the word faith, as used in the Scriptures, is not mere assent, or mere trust, it is the intelligent perception, reception, and reliance on the truth, as revealed in the gospel.

Everett Harrison: Paul himself goes on to explain in what sense “*power*” is to be understood. The stress falls not on its mode of operation but on its intrinsic efficacy. It offers something not to be found anywhere else – a righteousness from God.

C. Its Goal – not just temporarily changing lives for the better, but saving a person's life forever

C. Its Inclusiveness and Exclusiveness

Frank Thielman: This salvation is both **universal** in its reach and **individual** in its application.

John Toews: *To the Jews first and also to the Greek* explains *everyone*. And also indicates the fundamental equality of Jew and Gentile in the gospel. The word *first* denotes the historical reality that the Jews have precedence for the sake of God's plan. The letter insists there is no distinction (3:22; 10:12) yet supports the continuing validity of the Jew first. The thrust, on the one hand, is not to claim superiority for the Jew, but to argue for the equality of Jews and Gentiles. But, on the other hand, discrimination in Rome against Jews and Jewish Christians requires a reminder that God called the Jews first, and that God is and will be faithful to them. The tension between the priority of the Jew in salvation history and the equality of all people in the gospel is an issue to which Paul will return in the letter (see **chs. 3, 9-11**).

John Murray: In this text there is no suggestion to the effect that the priority is merely that of time. The implication appears to be rather that the power of God unto salvation through faith has **primary relevance to the Jew**, and the analogy of Scripture would indicate that this peculiar relevance to the Jew arises from the fact that the Jew had been chosen by God to be the recipient of the promise of the gospel and that to him were committed the oracles of God. Salvation was of the Jews (**John 4:22**; cf. **Acts 2:39**; **Rom. 3:1, 2; 9:4, 5**). The lines of preparation for the full revelation of the gospel were laid in Israel and for that reason the gospel is pre-eminently the gospel for the Jew. . . This priority that belongs to the Jew does not make the gospel less relevant to the Gentile.

II. (:17) BECAUSE THE GOSPEL REVEALS – THE RIGHTEOUSNESS OF GOD THAT IS APPROPRIATED BY FAITH ALONE

“For in it the righteousness of God is revealed from faith to faith; as it is written, ‘But the righteous man shall live by faith.’”

Answers the question: How can sinful man find acceptance with a holy God?

John Murray: In line with the force of the term “*revealed*” in these Old Testament passages we shall have to give to the word here (**vs. 17**) a **dynamic meaning**. When the prophet spoke of the righteousness of God as being “*revealed*” he meant more than that it was to be disclosed to human apprehension. He means that it was to be **revealed in action and operation**; the righteousness of God was to be **made manifest with saving effect**. So, when the apostle says, the “*righteousness of God is revealed*”, he means that in the gospel the righteousness of God is actively and dynamically brought to bear upon man’s sinful situation; it is not merely that it is made known as to its character to human apprehension but that it is manifest in its **saving efficacy**. This is why the gospel is the power of God unto salvation – the righteousness of God is redemptively active in the sphere of human sin and ruin.

A. The Source of the Gospel = comes to us by Divine Revelation

B. The Connection between Righteousness, Life, and Faith

1. God's righteousness

- a. Comes to us from God; we won't find it within ourselves
- b. Perfect righteousness (Illustration of a surgeon rejecting a contaminated scalpel – the amount of contamination does not matter)
- c. Greater than the Righteousness of the Pharisees (**Matt. 5:20**)
this is a God-righteousness; different from unrighteousness and different from any human righteousness
- d. Exactly what we need

Douglas Moo: “*righteousness of God*” -- Three interpretations are popular.

(1) “*God’s righteousness*”—an attribute of God. “Righteousness” can refer to God’s justice, but as Luther discovered long ago, it is hardly good news to disobedient sinners to learn about God’s justice. Thus it is more likely, if an attribute of God is in view, that the reference is to God’s faithfulness.

(2) “*Righteousness from God*”—a status given to people by God. This interpretation was championed by the Reformers and is the traditional view among Protestant theologians. When God “justifies” (the Gk. verb is *dikaioo*, cognate to the word for “righteousness”) the sinner, God gives that person a new legal standing before him—his or her “righteousness.”

(3) “*Righteousness done by God*”—an action of “putting in the right” being done by God. This view, held by a growing number of scholars, gives a dynamic sense to “righteousness.” It is God’s intervention to set right what has gone wrong with his creation.

The context does not point clearly in one direction. The verb “*reveal*,” which has a dynamic sense (*come into being, manifest*; see **1:18**) favors the third view. But the fact that this righteousness, as Paul goes on to say, is based on faith, favors the second view. . .

For Paul, as in the OT, “*righteousness of God*” is a **relational concept**. Bringing together the aspects of activity and status, we can define it as the act by which God brings people into right relationship with himself.

2. Spiritual Life

3. Genuine Faith (unmixed with anything else)

Don't wait to try to understand completely;
take advantage and respond to what you know

Thomas Schreiner: Saving faith, however, includes more than mental assent. It also involves commitment and reliance on God such as Abraham had in staking his whole future on God’s promises (**Rom. 4:18–22**). . . It is likely, then, that ἐκ πίστεως εἰς πίστιν is **emphatic** in nature, highlighting the **centrality** and **exclusivity** of faith.

Everett Harrison: Perhaps what it conveys is the necessity of issuing a reminder to the believer that justifying faith is only the beginning of Christian life. The same attitude must govern him in his continuing experience as a child of God.

Thomas Constable: The idea seems to be that faith is the method whereby we receive salvation, whatever aspect of salvation may be in view, and whomever we may be. The NIV interpretation is probably correct: “*by faith from first to last*.”

“Faith is the starting point, and faith the goal.” [**Lightfoot**]

“... man (if righteous [right before God] at all) is righteous by faith; he also lives by faith.” [**Barrett**]

Frank Thielman: Faith in God’s provision of Christ’s atoning death as the means for dealing with human sin brings righteousness to the believer, and this righteousness allows the believer to live.

John Witmer: In response to faith this righteousness is imputed by God in justification and imparted progressively in regeneration and sanctification, culminating in glorification when standing and state become identical.

C. This Connection is Consistent with the OT Teaching

“The just by faith shall live”

Thomas Schreiner: At this juncture we need to consider whether Paul’s use of the verse accords with the original context of Habakkuk. Yahweh threatens to punish sinful Judah because the nation has failed to keep God’s Torah (**1:4**). Such a judgment is a test of faith for the remnant. Will they still believe God’s promises, which include a future judgment of Babylon (**chap. 2**) and a future new exodus for Israel (**chap. 3**)? The many allusions to the exodus in **Hab. 3** indicate the promise of a new exodus, a new deliverance for the people of God. Hence Habakkuk functions as a paradigm for the people of God. He will continue to trust the Lord even if the fig tree doesn’t blossom and vines are lacking fruit (**Hab. 3:17–18**). He will continue to trust in and rejoice in God’s promise of future salvation in the midst of the impending judgment. The canonical context of the book assists us in interpreting **2:4**. Like Abraham, the people of God are summoned to trust in Yahweh when circumstances conspire against such trust. Thus the fundamental call of Habakkuk is to trust in the Lord (cf. **G. Davies** 1990: 44). This is not to deny that faithfulness flows from faith, for the former always proceeds from the latter. Faith is the foundation and faithfulness is the superstructure. It follows that Paul reads Habakkuk in both its **historical** and **canonical** context and doesn’t distort its message. A right relationship with God is obtained by faith, not by keeping the law.

* * * * *

DEVOTIONAL QUESTIONS:

- 1) In what situations do you find yourself ashamed of the gospel and how could this text address your hesitancy to witness?
- 2) How can you count on the efficacy of the power of the gospel in your everyday struggle against sin and temptation?
- 3) How can you best communicate to the sinner his need for God’s righteousness and how it is that man can obtain the righteousness that he needs?
- 4) Why is it important to understand that salvation is not just a human decision, but requires the very power of God in imparting new life?

* * * * *

QUOTES FOR REFLECTION:

John Murray: We might think that the negative way of expressing his estimate of the gospel, “*I am not ashamed of the gospel*” is scarcely consistent with the confident glorying which appears on other occasions (cf. **5:2, 3, 11; Gal. 6:14**) or with the confidence in the efficacy of the gospel enunciated later in these same verses. But when we remember the contempt entertained for the gospel by the wise of this world (cf. **1 Cor. 1:18, 23-25**) and also of the fact that Rome as the seat of world empire was the epitome of worldly power, we can discover the assurance which the disavowal reflects. The emotion of shame with reference to the gospel, when confronted with the pretensions of human wisdom and power, betrays unbelief in the truth of the gospel and the absence of shame is the proof of faith (cf. **Mark 8:38; 2 Tim. 1:8**)

Thomas Schreiner: To sum up, the argument made here is that the verbal phrase “*justified by faith*” and the noun phrase “*righteousness of God*” express the same idea, the right status believers have before God. An additional piece of evidence supporting a **forensic reading** is the use of both the verb “*justify*” and the noun “*righteousness*” in near context to each other.

I conclude that Paul isn't saying that human beings are **transformed** by faith; he teaches that **they stand in the right before God by faith**. God will announce publicly to the world the verdict “not guilty” on the last day, though this verdict already belongs to those who are united with Christ Jesus, since Jesus was vindicated at his resurrection as the righteous one (**1 Tim. 3:16**). Hence, the declaration that Jesus stands in the right is granted to all those who belong to him, to all those who are united with him by faith.

Grant Osborne: The Greek word for power (*dynamis*) is the source for our words *dynamite* and *dynamic*. Dynamite was not invented by Nobel until 1867, so it is obvious that Paul did not have that specific picture in mind. Instead, the inventor of the explosive took its name from the Greek. But the parallel is instructive. The gospel can be like spiritual dynamite. Under certain circumstances it has a devastating, even destructive effect, demolishing worldviews and traditions—paving the way for new construction. Placed inside a stone-hard heart that is resistant to God, it can shatter the barrier. God's power in the gospel is not only explosive; it also overcomes evil. Dynamite must be carefully handled, but it is very effective when put to its proper use. Keeping dynamite under lock and key, hidden by those who know about it, may keep it from being misused, but it also prevents the dynamite from doing what it was designed to do. The dynamite of the gospel deserves to be respectfully treated, but **effectively used!** Furthermore, it must never be used as a weapon, but as a constructive power.

The word dynamic also reminds us of another aspect of the gospel. While bringing spiritual life to a person, we cannot always predict the course it will take. Paul knew that Christians have the responsibility to proclaim the gospel whenever and wherever they can. Believers are not to be ashamed about its simplicity or universality—the gospel's effectiveness can be entrusted to God. Until we are convinced that the gospel is dynamic and effective, we will tend to be ashamed to pass it on. What has the gospel done in you? If the gospel is a message you know, but not a power that has changed you, it will matter little what you do with it.

Steven Cole: Because the gospel is the power of God for salvation to everyone who believes, we must believe it and proclaim it boldly.

God's righteousness is revealed in the gospel in that He can grant right standing to sinners because His Son met the righteous requirement of His perfect Law and died to pay the penalty that sinners deserve. Thus sinners are not justified by their own righteousness by keeping the Law (**Gal. 3:11**), but rather by God imputing the righteousness of Christ to them by faith. . .

“*Salvation*” includes both the negative aspect of being forgiven for all sin and delivered from the penalty of sin, but it also includes in it the positive idea of personal relationship with God, i.e., the restoration of a relationship previously ruined through sin (**Rom 5:10-11**). According to Paul, it is only the message of the cross that affects the power of God and restores the relationship between sinner and Lord.

David Thompson: PAUL WAS NOT ASHAMED TO PREACH THE GOSPEL OF GOD BECAUSE IT UNLEASHES THE POWER OF GOD AND REVEALS THE RIGHTEOUSNESS OF GOD.

Paul Washer: Regeneration vs Decisionism

[Paul exposes the common evangelistic practices of pressing people to depend on a simplistic decision of their own (“God loves you and has a wonderful plan for your life” – just say Yes to God -- rather than in the regenerating power of the true gospel.)

<https://media-cloud.sermonaudio.com/text/1021081230111.pdf>

Kevin Ivy: I am going to assume that, other than those who are fully devoted followers of Christ, there are 6 types of individuals here today. I want you to see if you find yourself in any of these groups. There are the...

1. **Disbelievers**—You don't believe the gospel or you don't believe it is the only way.
2. **Disinterested**—you don't care. You are living for this life and you are going to get the most fleshly pleasure and fulfillment you can get out of it and hope it all turns out ok in the end.
3. **Distracted**—you like the gospel, and want to believe and embrace it, you just don't have time. You are distracted with so much—work, family, fun, money matters, trials and troubles.
4. **Disillusioned**—hypocrites have turned you off to the gospel so you think it is all just a waste.
5. **Deceived**—you have been inoculated. False sense of assurance.
6. **Doubter**—you have believed, received, and embraced, but you just can't be sure. It is not that you have a false sense of assurance. You have no assurance.

Dan Kirk: Without the power of God through the gospel, no one ever receives the positive and negative benefits of the Gospel:

- Negatively it rescues us from sin's guilt.
- Positively it brings God's righteousness.
- Negatively it takes away our impurity.
- Positively it gives us holiness.

- Negatively it removes us from slavery to sin.
- Positively it ushers us into freedom.
- Negatively, it removes our punishment.
- Positively it fills us with blessedness and joy!
- Negatively it removes our alienation from God forever.
- Positively it brings us into fellowship with God.
- Negatively it removes the wrath of God.
- Positively it brings the love of God which is shed abroad in our hearts.
- Negatively it withholds everlasting death.
- And positively it grants to us everlasting life with God forever.

<https://media-cloud.sermonaudio.com/text/316212048507400.pdf>

Leedy Greek NT Diagrams:

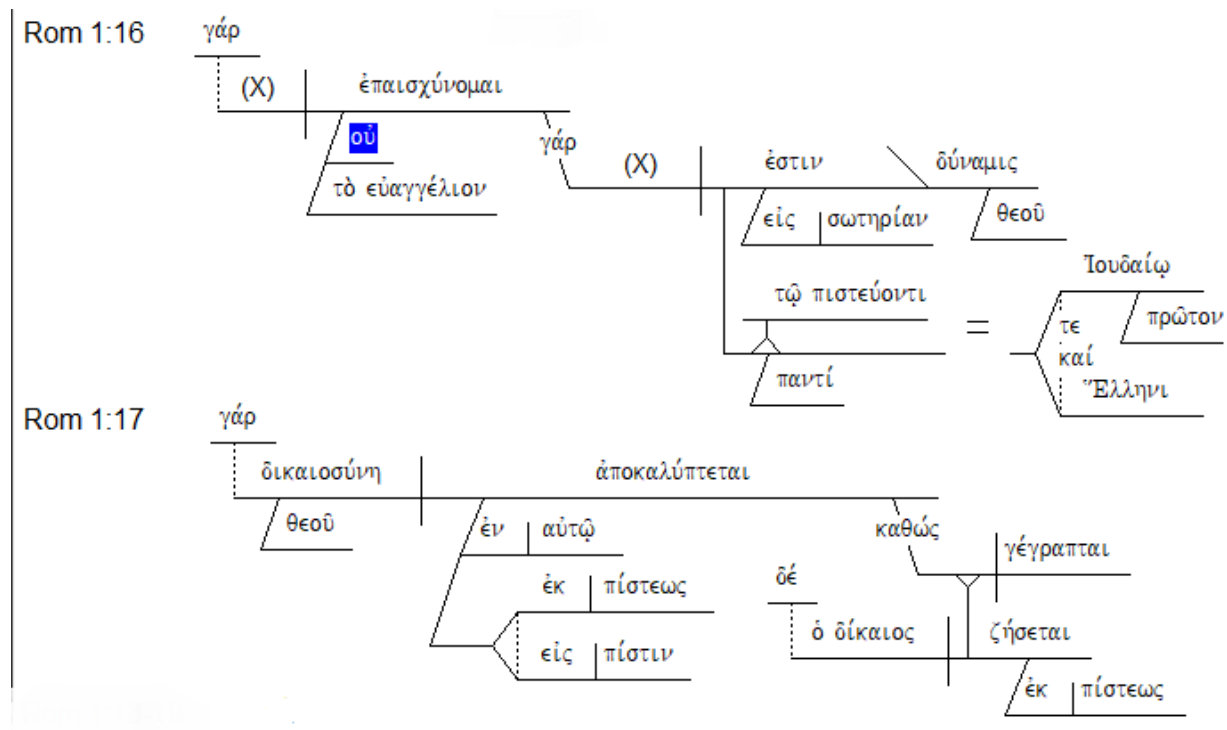

Frank Thielman:

- | | | | |
|-----|--------------------|-------------------------|--|
| 16a | Explanation | For I am not ashamed of | the gospel, |
| b | Explanation | for | it is the power of God for salvation |
| | | | to everyone who believes, |
| c | Restatement | | to the Jew first, and also to the Greek. |
| 17a | Explanation of 16b | For | the righteousness of God is revealed |
| b | Sphere | | in it |
| c | Means | | from faith to faith, |
| d | Verification | | just as it is written, |
| | | | “But the one who is righteous by faith will live.” |
| | | | (Hab 2:4) |

TEXT: ROMANS 1:18-23

TITLE: NO EXCUSES FOR REJECTING GOD'S TRUTH

BIG IDEA:

REJECTING WHAT WE NATURALLY KNOW ABOUT GOD LEAVES US WITHOUT EXCUSE AND ALWAYS BRINGS GOD'S WRATH

INTRODUCTION:

Douglas Moo: Verse 18 comes to the reader as quite a surprise. Paul has just announced his theme for the letter: the gospel as God's saving power, revealing his righteousness to all who believe. But instead of the exposition of these wonderful truths, we get dire news about God's wrath against sin. Indeed, it is not until fully two chapters later, in 3:21, that Paul finally picks up on the themes he broached in 1:16–17. Why is this? Apparently Paul thinks it necessary to make clear just why the revelation of God's righteousness in the gospel is necessary. Only by fully understanding the "bad news" can we appreciate the "good news." Thus, Paul goes to some lengths to detail for us the nature and dimension of the human predicament (1:18–3:20).

James Dunn: (1:18 – 3:20) **The Wrath of God on Man's Unrighteousness** –

1:18, with its double use of ἀδικία as a summary of human failure, serves as a heading for the whole section, to which the repetition of the word in 1:29, 2:8, and 3:5 recalls the reader. The indictment focuses first on man as such, but in effect on the Gentile "them" over against the Jewish "us" (1:18–32), then on "the Jew" himself (2:1–3:8), before summing up in 3:9–20. That is to say, the principal focus of critique is Jewish self-assurance that the typically Jewish indictment of Gentile sin (1:18–32) is not applicable to the covenant people themselves (2:1–3:20; cf. Synofzik, 87–88).

Frank Thielman: When God punishes human rebellion against himself, he acts as a righteous judge both in deciding to punish human beings and in the way he executes the punishment. They cannot plead ignorance in their defense, since he holds them responsible for acting in accord with the truth about himself that he has clearly shown to them in creation. They also cannot plead that his punishment is too harsh, because he has handed them over to the consequences of their own choice to rebel against the truth he has revealed.

John Toews: Paul is not making the case for a natural theology, that men and women can reason their way to God from nature (the argument from below to above), but asserts that humanity has no excuse because it has continuous access to knowledge of God.

The sin of humanity is that men and women did not glorify God or give thanks. Humanity knew God, but did not recognize or honor God. The fundamental human perversion is **rejection of God**.

Grant Osborne: Paul's description of the case against humanity can be outlined in three steps:

- (1) Man demonstrated an **aversion** to faith in God alone.
- (2) This was followed almost immediately by a **diversion** from God's way of thinking.
- (3) This led to **perversions** in relations with God (idolatry) and in relations among people (immorality).

The evidence against humanity requires the verdict of **guilty as charged**.

Steven Cole: To say that the concept of God's wrath is out of sync with our modern world is to state the obvious. Even many who claim to be evangelicals object to and minimize any mention of God's wrath. They may *say* that they believe it because it's in the Bible, but they're embarrassed by it. I've even heard of professing Christians who say, "I believe in a God of love, not a God of wrath." Sometimes such people ignorantly imply that the God of the Old Testament was a God of wrath, but by the New Testament, He mellowed out to be a nice old guy! I've been told that Jesus was always loving and never judgmental. I always want to ask such people, "When was the last time you actually read the New Testament?" . . .

God is just in pouring out His wrath on the human race because we have sinfully rejected His revelation of Himself and have worshiped the creature rather than the Creator.

I. (:18) SUPPRESSION OF TRUTH -- GOD ALWAYS RESPONDS IN WRATH AGAINST THOSE WHO REJECT HIS REVEALED TRUTH

A. Divine Wrath is Real and Revealed

1. Divine Wrath is Real

"For the wrath of God"

God by nature is a God of wrath – you doubt this at your own peril;

Divine wrath is emphasized in the Bible – look at word usage of "*wrath*," "*anger*," "*fury*" – over 400 times

Steven Cole: **J. I. Packer** (*Knowing God* [IVP], pp. 134-135) said, "One of the most striking things about the Bible is the vigor with which both Testaments emphasize the reality and terror of God's wrath." **A. W. Pink** (*The Attributes of God* [Baker], p. 82) wrote, "A study of the concordance will show that there are more references in Scripture to the anger, fury, and wrath of God than there are to His love and tenderness." So we cannot shove God's wrath into the closet!

R. W. Dale observed (cited by **R. C. Sproul**, *The Cross of Christ Study Guide* [Ligonier Ministries], p. 35), "It is partly because sin does not provoke our own wrath, that we do not believe that sin provokes the wrath of God."

R. Kent Hughes: God is a God of "*wrath*," or as some translations have it, "*anger*." It is important that we understand exactly what this means or the rest of the passage will be confusing. First, it does not mean that God is given to a capricious, uncontrolled anger. There are two basic words in the Greek language used to express anger. From *thumos* we get our words thermometer and thermos. This is red-hot anger—the kind that overcomes people when they lose control and punch someone on the nose. It is impulsive and passionate. That is not the word used

in our text. The word here is *orge*, which signifies a settled and abiding condition. It is controlled. “*The wrath of God*” is not human wrath, which at its best is only a distorted reflection of God’s wrath because it is always compromised by the presence of sin. “*The wrath of God*” is **perfect, settled, controlled**.

2. Divine Wrath is Revealed “*is revealed from heaven*”

James Dunn: The clear implication is that the two heavenly revelations are happening concurrently, as well as divine righteousness, so also divine wrath; to take the second ἀποκαλύπτεται as future (**Eckstein**) destroys the parallel and draws an unnecessary distinction between God’s wrath and the divine action in “*he handed over*” in παρέδωκεν (**vv 24, 26, 28**). In the OT the wrath of God has special reference to the covenant relation (SH), but here the implication, quickly confirmed (**vv 19 ff.**), is that Paul is shifting from a narrower covenant perspective to a more **cosmic or universal perspective**, from God understood primarily as the God of Israel to God as Creator of all. . .

In brief, his resolution is that the effect of divine wrath upon man is to show that man who rebels against his relation of creaturely dependence on God (which is what faith is) becomes subject to **degenerative processes**.

John Toews: The point of **v. 18** is that the end-time wrath of God is **now** being revealed in the world through the gospel just as the end-time righteousness of God is being revealed. It is being revealed now, in contrast to a Jewish emphasis on its future manifestation, though it will be revealed fully in the future. The wrath of God has both a **present** and a **future dimension** just as does the righteousness of God.

Look at historic biblical examples:

- The Curse instituted at the Fall (including pain of childbirth and difficulty of working in a hostile environment)
- Wrath unleashed against the pride of men at the Tower of Babel
- Wrath unleashed in the worldwide Flood in the days of Noah
- Wrath unleashed against Pharaoh and Egypt in the Exodus
- Wrath unleashed against the unbelieving generation in the wilderness
- Wrath unleashed in the Babylonian Captivity

John MacArthur: And above all, I believe the greatest demonstration of the wrath of God ever given was given **on Calvary’s cross**. God hates so deeply sin that He actually allowed His own Son to be put to death, the greatest manifestation of the wrath of God. He poured out His fury on His own beloved Son. He would not hold it back even from His own Son. That’s how He hated sin.

Thomas Schreiner: God’s judgments in history, then, **anticipate** the culmination of his wrath on the day of judgment (cf. **Schnabel** 2015: 211; **Kruse** 2012: 88).

Why should we believe that God is still a God of wrath today?

- Present tense of the verb (*is being displayed openly*)
- God is Unchanging

B. Divine Wrath is Deserved

1. Due to Sin

“against all ungodliness and unrighteousness of men,”

James Dunn: the ἀδικία of men is clearly set in antithesis to the δικαιοσύνη of God (v 17; note also 3:5; cf. 1QS 3.20). “*Unrighteousness*” is thus more precisely defined as failure to meet the obligations toward God and man which arise out of relationship with God and man. That the two aspects of unrighteousness go together and follow from failure to recognize and accept what is man’s proper relation to God is the thrust of what follows. It is this unrighteousness on the part of men which makes necessary the initiative of God’s righteousness.

Timothy Keller: What draws God’s anger is “*godlessness and wickedness.*” The first speaks to a disregard of God’s rights, a destruction of our vertical relationship with him. The second refers to a disregard of human rights to love, truth, justice etc, a destruction of horizontal relationships with those around us. It is a breaking of what Jesus said were the greatest two commandments: to love God, and to love our neighbor (**Mark 12:29-31**).

John Toews: The two words together offer a **complete description of sin**. *Ungodliness* focuses sin as an attack on the holiness and majesty of God. *Unrighteousness* defines sin as a violation of God’s just order in the world. Both stand opposed to the righteousness of God, and both are characterized as **assaults on the truth**.

2. Due to Suppression of Revealed Truth

“who suppress the truth in unrighteousness,”

Frank Thielman: God’s wrath is an expression of his righteousness because it is fair: he brings it against human beings who know the truth about him but intentionally stifle that truth.

R. Kent Hughes: What mankind holds down is the basic knowledge of the majestic transcending power of God as Creator and Sustainer. I cannot agree with those who think that this verse teaches a full-blown natural theology wherein all the attributes of God are easily discernible to the observer of nature, so that by watching the universe they come to the explicit conclusion of God’s existence and the need for the sacrifice of Christ. Our text is very clear that “*his invisible attributes*” are “*his eternal power and divine nature*” (v. 20), and that is what Nature reveals. Along with this, man sees by implication his own finiteness—the great gulf between himself and God. . .

Noting the order and design of our universe, **Kepler**—founder of modern astronomy, discoverer of the “*Three Planetary Laws of Motion*,” and originator of the term satellite—said, “The undevout astronomer is mad.”

Lenski: Whenever the truth starts to exert itself and makes them feel uneasy in their moral nature, they hold it down, suppress it. Some drown its voice by rushing on into their immoralities; others strangle the disturbing voice by argument and by denial.

Application: How do we know whether we are in danger of God's Wrath?
Are we suppressing the truth in unrighteousness?

II. (:19-20) ACCESS TO TRUTH -- GOD HAS CLEARLY REVEALED HIMSELF IN NATURE SO THAT MEN ARE WITHOUT EXCUSE

(What about those who haven't heard about the gospel of Jesus Christ?

How can God ever be angry with them?)

A. (:19) Universal Internal Awareness of God's Truth

*“because that which is known about God is evident within them;
for God made it evident to them.”*

Ps. 53 -- it is a fool who says there is no God

Steven Tackett: Remember, the Gentiles were never given the Law of Moses. However, all show the work of the law written in their hearts. How is this possible? It is because God gave all men a conscience; the ability to know the difference between right and wrong. **Everyone knows there is a God.** They know it naturally; they know it inherently. No one can look at creation and say there is no God. The other part of inherently knowing the difference between right from wrong is knowing **there are consequences to their actions.** We know inherently that there is right and wrong and that wrong must be punished. It is for that reason that their conscience also bearing witness and their thoughts the mean while accusing or else excusing one another. So, what people naturally do, they either accuse or excuse.

Michael Bird: Theologians have sometimes spoken of a **twofold natural knowledge of God.** First, an **innate knowledge** of God is hardwired into human existence — a sense of the divine, or an inherent awareness of God's being that connects immediately with human existence. Second, a **derivative knowledge** of God can be inferred from the immensity, order, and beauty of creation itself. Paul arguably refers to a knowledge of God of this order that is manifested, literally, “*in them*” (en autois) in vv. **19 – 20**. As **Schreiner** comments, “God has stitched into the fabric of the human mind his existence and power, so that they are instinctively recognized when one views the created world.”

Frank Thielman: Paul implies by this statement that human beings cannot know everything about God. They can only know as much about him as God allows them to know, but he has allowed all human beings to know enough to hold them responsible for worshiping him and treating one another justly.

Newell: Napoleon, on a warship in the Mediterranean on a star-lit night, passed a group of his officers who were mocking at the idea of a God. He stopped, and sweeping his hand toward the stars, said, “Gentlemen, you must get rid of those first!”

John MacArthur: General revelation is the foundation of all condemnation. Men have the opportunity because God is evident everywhere.

B. (:20a) Universal External Revelation of God's Truth Via Nature

1. Natural Revelation Began at Creation

"For since the creation of the world"

Robert Gundry: "*Since the world's creation*" doesn't leave human beings a chronological excuse for their ungodliness and unrighteousness any more than they have the excuse of unclarity. God's everlasting power and deity have been clearly visible and thus understood from the very start. Ignorance is no excuse, but human beings can't even plead ignorance as an excuse. Why? Because "*they knew God*" but "*didn't glorify [him] as God.*"

2. Natural Revelation Makes Plain Key Invisible Divine Attributes

"His invisible attributes, His eternal power and divine nature, have been clearly seen,"

R. Kent Hughes: We must ever keep before us the "*eternal power and divine nature*" of God as revealed in creation! We must always consciously strive to remember his **majestic transcendence** and his "**otherness**" or we will fall into idolatry. Quite frankly, even those of us in the evangelical tradition, with its valid and needed emphasis on the availability of God in Christ, are in danger of this form of idolatry. Very often we hear God addressed in casual terms that would scandalize some of our earthly employers. Sometimes we hear music that so sentimentalizes Christ that he is emptied of his divinity. We need to be careful! We must never address God with anything but the most humble attitude. We must never jest about him or about divine things. **We must keep our own creatureliness and his supremacy before us.**

John Calvin: (*Calvin's Commentaries* [Baker], pp. 71-72), His eternity appears evident, because he is the maker of all things—his power, because he holds all things in his hand and continues their existence—his wisdom, because he has arranged things in such an exquisite order—his goodness, for there is no other cause than himself, why he created all things, and no other reason, why he should be induced to preserve them—his justice, because in his government he punishes the guilty and defends the innocent—his mercy, because he bears with so much forbearance the perversity of men—and his truth, because he is unchangeable.

Illustration of missing cupcake -- "the evidence is all over the little boy's face"

Nature reveals power, orderliness, consistency, faithfulness

Natural revelation sufficient to condemn but not to save --

Specific gospel message about Christ is still needed

3. Natural Revelation Enhances Human Understanding

"being understood through what has been made,"

Thomas Constable: Four things characterize natural revelation:

- First, it is a clear testimony; everyone is aware of it.
- Second, everyone can understand it. We can draw conclusions about the Creator from His creation. "His invisible attributes ... have been clearly perceived" is an oxymoron (a figure of speech in which apparently contradictory terms appear together).
- Third, this revelation has gone out since the creation of the world in every generation.
- Fourth, it is a limited revelation in that it does not reveal everything about God (e.g., His love and grace) but only some things about Him (i.e., His power and divine nature).

C. (:20b) **Universal Condemnation of All Men**

"so that they are without excuse."

Conclusion: God will judge men against the revelation they have.

III. (:21-23) **PERVERSION OF TRUTH -- FALLEN MEN REPLACE GOD'S GLORIOUS TRUTH WITH THINGS THAT ARE FAR INFERIOR**

A. (:21a) **The Privilege of Revelation Brings Accountability**

1. Privilege of Revelation

"For even though they knew God,"

2. Accountability

a. Do We Honor God?

"they did not honor Him as God,"

Thomas Schreiner: We need to reflect further on the main thesis that Paul advances. **Failing to glorify God is the root sin.** Indeed, glorifying God is virtually equivalent with rendering him proper worship, since Paul describes (v. 25) the same reality as surrendering the truth of God for worship of the creature (**Hooker** 1959–60: 305). We saw in **1:17** that the righteousness of God is rooted in his desire for the glory and honor of his name. He saves his people because it will bring glory to his name. It is hardly surprising to see, then, that **the essence of sin is a rejection of God's glory and honor.** Sin doesn't consist first and foremost in acts that transgress God's law, although **verses 24–32** indicate that sin includes the transgression of the law. Particular sins all stem from a rejection of God as God, a failure to give him honor and glory.

b. Do We Give Thanks?

"or give thanks;"

James Dunn: Paul is obviously thinking more in terms of thanksgiving as **characteristic of a whole life**, as the appropriate response of one whose daily experience is shaped by the recognition that he stands in debt to God, that his very life and experience of living is a gift from God (cf. 4 Ezra 8.60); cf. **Kuss**. In Paul's perspective this attitude of awe (the fear of the Lord) and thankful dependence is how knowledge of God should express itself. But human behavior is marked by an irrational disjunction between what man knows to be the true state of affairs and a life at odds with that knowledge. This failure to give God his due and to receive life as God's gift is Paul's way of expressing the primal sin of humankind.

B. (:21b-23) The Rejection of Revelation Replaces Glorious God with Inferior Idols

1. (:21b) Darkening of Mind and Heart

a. Impact on Mind

“but they became futile in their speculations,”

b. Impact on Heart

“and their foolish heart was darkened.”

James Dunn: Paul’s point is that man’s whole ability to respond and function not least as a rational being has been damaged; without the illumination and orientation which comes from the proper recognition of God his whole center is operating in the dark, lacking direction and dissipating itself in what are essentially trifles.

Thomas Schreiner: The **limitations** of one’s knowledge of God through natural revelation should be acknowledged. Nothing is said here about God’s mercy and love. The natural order with its hurricanes, earthquakes, and floods does not clearly or always communicate God’s love. The revelation through nature doesn’t bring salvation; Paul’s purpose is to underscore that the knowledge of God obtained through creation is suppressed and therefore distorted.

Grant Osborne: The heart is the seat of feeling, intelligence, and moral choice. Their hearts are foolish because they refuse to recognize God (see **1:22**). Futile thinking is followed by futile living. Then both mind and heart become devoid of light. When confused thinking becomes a permanent mind-set, people are unable to turn to God.

2. (:22) Delusion

“Professing to be wise, they became fools,”

3. (:23) Degeneration

“and exchanged the glory of the incorruptible God for an image in the form of corruptible man and of birds and four-footed animals and crawling creatures.”

Michael Gorman: Nature abhors a vacuum, so desertion of the one true God led to blatant idolatry (**1:23, 25**) in an act of exchange (**1:23, 25**; see also **1:26**). Godlessness, or being un-godded, is impossible for humans, and so it inevitably devolves into idolatry. This idolatry led in turn to various immoralities (**1:24, 26–27, 28b–31**; cf. **Eph 4:17–19**). As **John Calvin** observed, “Surely, just as waters boil up from a vast, full spring, so does an immense crowd of gods flow from the human mind, while each one, in wandering about with too much license, wrongly invents this or that about God himself.” In fact, **Calvin** adds, human nature is “a perpetual factory of idols.” . . . **Stephen Fowl**, in his book *Idolatry*, argues that a basic meaning of idolatry is **pledging allegiance to something that is not God**. This does not happen overnight, however. We don’t wake up and say, “Today I will become an idolater!” Rather, Fowl maintains, idolatry is a process of small decisions and compromises that create dispositions, habits, and practices that eventually become idolatry. The result, says Paul, is behavior that is appropriate to the resulting misplaced devotion and allegiance. But such behavior is a misguided

replacement for the sort of behavior appropriate to a covenantal relationship of love and obedience to God.

Frank Thielman: Paul designed his description of what human beings worshiped instead of God to emphasize the **ridiculous nature of the exchange**. Human beings worshiped “*the likeness of the image of corruptible humanity*.” The wordiness of the phrase is a rhetorical move called **pleonasm**, which multiplies words to “enrich the thought.” Here, Paul is communicating just how far human beings had moved from the worship of the incorruptible God. According to **Genesis 1:26** (LXX), human beings were made in the “*image*” (εἰκών) and “*likeness*” (ὁμοίωσις) of God, but here Paul speaks not even of people worshiping other people but of people worshiping “*the likeness of the image*” of other people, something God had expressly forbidden in **Deuteronomy 4:16** (LXX). In contrast to God, moreover, human beings are “*corruptible*” (φθαρτός), that is, they wither and die quickly. As if this were not enough, people moved ever further from God as they gave their worship to a variety of animals. Paul’s list follows an order that matches the animals’ habitats from high to low, moving from the heavens (“*birds*”) to just above the surface of the earth (“*quadrupeds*”) to the surface of the earth itself (“*reptiles*”)—ever further, in other words, from God.

Timothy Keller: We must worship something. We were created to worship the Creator, so if we reject him, we will worship something else. We are “tellic” creatures—purposed people; we have to live for something. There has to be something which captures our imagination and our allegiance, which is the resting place of our deepest hopes and which we look to calm our deepest fears. Whatever that thing is, we worship it, and so we serve it. It becomes our bottom line, the thing we cannot live without, defining and validating everything we do. . .

This exchange in our worship and service undoes the created order. Humans are uniquely made in the image of God, made to relate to him in his world and reflect his nature and goodness to the world (**Genesis 1:26-29**). In **Romans 1:23**, humanity turns its back on God and turns to bowing down to created things. We do not worship what is immortal; we worship what is made. Put another way, we do not worship the Creator; we worship the created (**v 25**).

From God’s perspective, this is the behavior of “*fools*” (**v 22**). How has this happened? Because, Paul says in a few very revealing words in **verse 21**, in refusing to treat God as God, and live in dependence on and gratitude to him, “*their thinking became futile and their foolish hearts were darkened*.” In order to suppress the truth that there is a Creator, people engage in non-sequiturs and irrational leaps. Since the fundamental truth about God is being held down and ignored, life cannot be lived in a consistent way.

* * * * *

DEVOTIONAL QUESTIONS:

- 1) Are you offended by the concept of God’s wrath or tempted to minimize it in discussions with sinners?
- 2) Why is it so important to hold on to the biblical view of Creationism rather than compromise

with naturalistic theories of evolution?

- 3) How does the level of received revelation correlate to the severity of God's judgment?
- 4) How can we give more attention to the fundamental issues of glorifying God and giving thanks?

* * * * *

QUOTES FOR REFLECTION:

David Thompson: Verse 18 begins a section in Romans that develops from **1:18-3:20**. The theme of this section is not positive or popular. The theme is ALL MANKIND STANDS GUILTY BEFORE GOD AND IS UNDER THE WRATH OF GOD.

Donald Grey Barnhouse called this section "...the charge of the prosecution in the case against man."

Dr. S. Lewis Johnson entitled his exposition of this section "All mankind on death row."

Dr. Charles Ryrie called this section "God's indictment of the world."

Dr. C. I. Scofield called this "The Whole world guilty before God."

D. Martyn-Lloyd Jones said, this is "the most perfect summary of the history of man that can be found even in the Bible."

God is the sovereign judge and jury and according to His assessment, every human being stands guilty and condemned and is heading toward His wrath. It doesn't matter what the gender, what the ethnicity, or what the religion or the sin. All are guilty. . .

Paul is building a case for the **guilt of every human**. Every human being, no matter who they are or where they live, is guilty and deserves God's wrath. By their works they prove they do not have God's righteousness and deserve God's wrath. So far he has built a strong case, but he is far from over:

- 1) People are guilty because they do ungodly and unrighteous things. **1:18a**
- 2) People are guilty because they suppress the truth God gives them. **1:18b**
- 3) People are guilty because they reject clear evident knowledge God put within them. **1:19**
- 4) People are guilty because they reject His power and Deity in Creation. **1:20**

Now as we come to [verses **21-23**], what we see is this: GOD'S RIGHTEOUSNESS IS PERFECTLY JUST IN POURING OUT HIS WRATH ON PEOPLE BECAUSE THEY HAVE REJECTED HIM AND DEMEANED HIM BY BRINGING HIM DOWN TO DETESTABLE LEVELS.

Michael Bird: What is more, a further connection between v. 17 and v. 18 is that the revelation of God's wrath is itself a manifestation of God's righteousness. Let us remember that the biblical background for God's righteousness refers to God's saving justice for Israel. Yet God would save Israel by entering into contention against her enemies, such as the Canaanites, the Assyrians, or the Babylonians. God's deliverance of Israel was principally through his retributive judgment of Israel's enemies, establishing justice over the earth; this was his "*righteousness*" (e.g., Isa 11:3 – 5; Pss 89:5 – 18; 98:1 – 9). Yet the Israelites also knew that God could enter into contention against them, and they would ask God to pardon them for no other reason than his covenant faithfulness toward them; this too was his "*righteousness*" (e.g., Pss 51:14; 143:1 – 3; Dan 9:2 – 19). God's saving righteousness and his punitive wrath are then different aspects of the one event.

Thus, God's righteousness is a duality containing both a punitive verdict and a pardoning vindication, judgment and justification, retribution and redemption. The upshot is that the shift from v. 17 to v. 18 is a shift from God's saving justice to God's retributive justice. As such, v. 18 is not introducing a new topic. I would paraphrase the verse as, "In speaking of God's saving justice, we cannot forget his punitive justice against evil either. For the righteous rage of God is even now being revealed from heaven against all who act without recourse to God and who descend into utterly wicked ways." . . .

The point is that God's anger burns against people who commit vertical sins against God (i.e., godlessness) and horizontal sins against their fellow humans (i.e., wickedness). This behavior derives from a suppression of the truth about God — a keeping down the truth that God is there and that he will treat each according to their deeds. Evidently God's existence and justice are so traumatic for people who treasure their personal evils that they are left with only one option to cope with such a predicament: **denial**.

Witmer: God never condemns without just cause. Here three bases are stated for His judgment of the pagan world.

- a. For suppressing God's truth (1:18) . . .
- b. For ignoring God's revelation (1:19-20) . . .
- c. For perverting God's glory (1:21-23) . . .

Thomas Schreiner: Despite some impressive arguments in favor of including both Jews and gentiles, five points indicate that Paul probably refers to gentiles in 1:19–32, with **verse 18** being understood as the **theme verse** for all of 1:18–3:20 (cf. Schnabel 2015: 204–5).

- First, the critique here is remarkably similar to the typical Jewish view of gentile idolatry. It has often and rightly been noted that this text reflects Jewish tradition, especially Wis. 11–15 (so Adams 1997: 49). Paul's appeal to creation as a standard of judgment instead of the law also points to an indictment of gentiles (Adams 1997: 48–49). A Jew reading **Rom. 1** would naturally conclude that Paul was criticizing the pagan world.
- Second, the overt form of idolatry depicted was virtually nonexistent among Jews of Paul's day but was almost routine among the gentiles.
- Third, homosexual relations were not uncommon in the Greco-Roman world, while they were consistently frowned upon by Jews. Jews who practiced same-sex relations

doubtless existed, but if they remained in Jewish society, they almost certainly kept it a secret to avoid social ostracism. Upon reading this section a Jew would inevitably think of the vices of gentile culture.

- Fourth, most Jews would not fit with the criticism enunciated in **verse 32**. They would not endorse the sins of others but condemn them, whereas the evil of the gentile world was expected, since gentiles were outside the covenant of the one true God.
- Last, it is true that **Ps. 106:20** and **Jer. 2:11** refer to the idolatry of the Jews, but here Paul applies those texts to gentiles (**Fitzmyer** 1993c: 270–71; **Esler** 2003b: 148–49).

The strategy of Paul’s argument is comparable to what we find in **Amos 1–2** (**Popkes** 1982: 499). Paul attacks the gentiles first, and while the Jews are saying “amen,” he implicitly indicts them as well, and his indictment will come into the open in **chapter 2**. In other words, **1:19–32** is directed against the gentiles, but upon reading **chapter 2** a Jew would begin to understand that they are not exempt from the charges pressed in **chapter 1**. The allusion to **Ps. 106:20** suggests that the Jews are implicitly in view even at this juncture of Paul’s argument.

Grant Osborne: **Psalm 19:1–4** says, “*The heavens declare the glory of God; the skies proclaim the work of his hands. Day after day they pour forth speech; night after night they display knowledge. There is no speech or language where their voice is not heard. Their voice goes out into all the earth, their words to the ends of the world*” (NIV). One look at creation in all its splendor tells people that a mighty power made this world—but not just an abstract, impersonal force; rather, a personal God. Thus, creation shows both God’s eternal power and his divine nature. Indeed, nature reveals a God of might, intelligence, intricate detail, order, beauty, and power; a God who controls powerful forces. God’s qualities are revealed through creation (**Acts 14:17**), although creation’s testimony has been distorted by the Fall. Adam’s sin resulted in a divine curse upon the whole natural order (**Genesis 3:17–19**), thorns and thistles were an immediate result, and natural disasters have been common from Adam’s day to ours. Nature itself is eagerly awaiting its own redemption from the effects of sin (**8:19–21**; **Revelation 22:3**).

How can intelligent people turn to idolatry? Idolatry begins when people reject what they know about God. Instead of looking to him as the Creator and sustainer of life, they see themselves as the center of the universe. They soon invent gods that are convenient projections of their own selfish plans and decrees. These gods may be wooden figures, or they may be things we desire—such as money, power, or comfort. They may even be misrepresentations of God himself—a result of making God in their image, instead of the reverse. The common denominator is this: Idolaters worship the things God made rather than God himself. It is a tendency that we must constantly watch for in ourselves.

S. Lewis Johnson: It is important for us because it is the passage that contains an answer to the perennial question, “**Are the heathen lost?**” And the apostle answers it very directly for he says of all men that they are without excuse. It is a passage, also, that illustrates a very important principle that we’ll talk about a little bit later on. And that is that **perversion in life stems from perversion in faith** and that’s why the faith is so important for us. That’s expressed in verse 18 and again in other places throughout this passage.

Among theologians who study this passage, Romans chapter 1, verse 18 through verse 23, is known as the **classic passage on natural theology**. That is, the things that we can know by looking at nature as God created it, and, Paul has a very important word to say concerning that here. He begins by speaking of the wrath of God as being revealed from heaven upon all unrighteousness and ungodliness of men who are holding down the truth in unrighteousness.

Leedy Greek NT Diagrams:

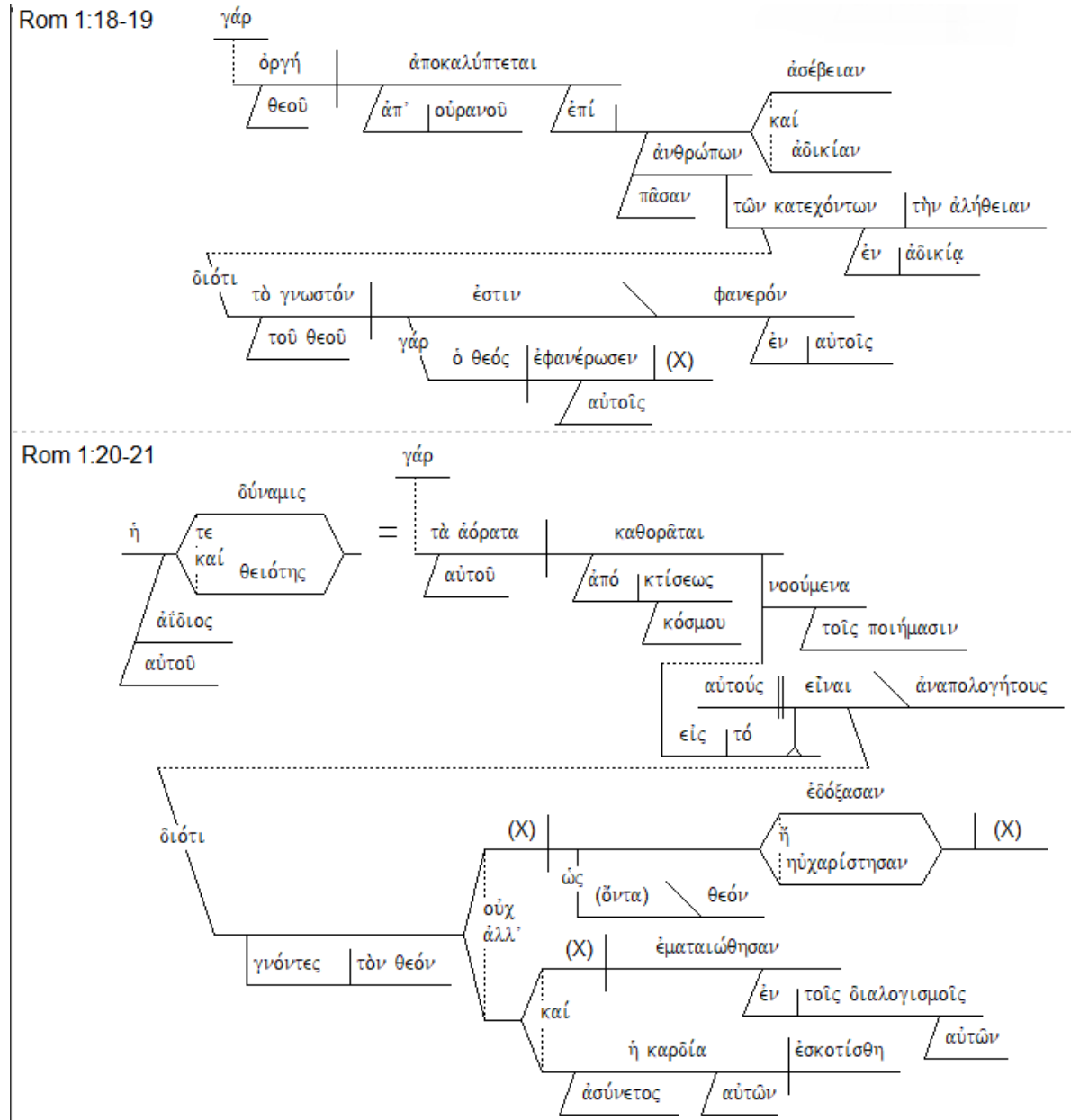

Rom 1:22-23

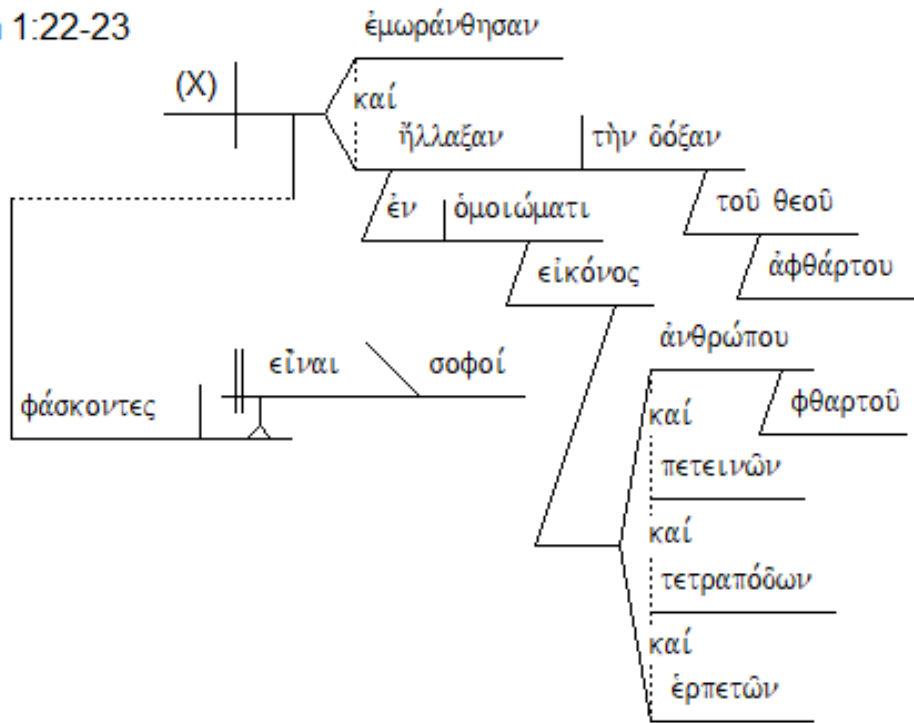

Frank Thielman:

- 18a Explanation For **the wrath of God** **is revealed**
 b Source from heaven
 c Disadvantage against all the impiety and unrighteousness
 d Source of human beings
 e Description who stifle the truth
 f Sphere in unrighteousness.
- 19a Basis of 18a For **what is knowable about God is** **visible**
 b Identification to them,
- c Basis of 19a for **God has made it** **visible**
 d Identification to them
- 20a Explanation of 19c for **his unseen attributes are** **clearly seen**
 b Cause because they are perceived
 c Means through what is made
 d Time from the time of the world's creation
- e Restatement (that is, his eternal power and divinity)
- f Result with the result that they are without excuse.
- 21a Concession For, although they knew God,
 b Basis of 20f **they did not glorify or**
thank him as God
- c Contrast but **they were rendered futile**
 d Sphere in their reasoning processes
- e Contrast and **their foolish heart was darkened.**
- 22a Concession Claiming to be wise,
 b Assertion **they became fools**
- 23a Assertion and **they exchanged the glory of the incorruptible God**
 b Contrast for the likeness of the image of corruptible humanity and
 c List birds and
 d quadrupeds and
 e reptiles.

TEXT: ROMANS 1:24-32

TITLE: *THE DOWNWARD SPIRAL TO TOTAL DEPRAVITY AND DISINTEGRATION OF SOCIETY*

BIG IDEA:

A SOCIETY THAT ABANDONS TRUTH (THEIR KNOWLEDGE ABOUT GOD) IS IN DANGER OF BEING ABANDONED BY GOD TO GROSS SIN AND IMMORALITY

INTRODUCTION:

Examples of Sodom and Gomorrah; Roman Empire; etc. – Look at their manifestation of depravity and the disintegration of their societies.

What is the present state of decadence in the U.S.? How far along are we on this downward spiral?

Thomas Schreiner: The content of **verses 24–32**, however, indicates that the emphasis of the text has shifted, since now Paul details the consequences of failing to worship and honor God. God gave people over to sexual sin (**24**), because they abandoned the true God and worshiped idols (**25**). Therefore, God gave people over to same-sex desires and actions (**26–27**). . . . Sexual sin is a consequence, or outworking, of the rejection of God and a failure to honor him. The fundamental sin isn't sexual but the **failure to worship God**. All other sin is a consequence of this one (**Käsemann** 1980: 47). The fundamental truth of the universe is that God exists and that he should be worshiped and served and his name should be praised (**v. 25**).

R. Kent Hughes: The logic here is so clear: first a **suppression** of the majestic revelation of God, then a perversion to **man-centered idolatry**, and finally a **perversion of man himself**. “In the end their humanism (man-centeredness) resulted in the dehumanization of each other.” In the end, man lowers himself to a condition below God's created purpose. As we will see in our next study, man, having rejected the witness of God in creation, goes on to live contrary to the very order of creation.

We have seen something of the “why” of the wrath of God, but our text also tells us something of the “how” of God's wrath: “*God gave them up . . . to impurity.*” This terrifying phrase (“*God gave them up*”) is repeated three times before **chapter 1** closes. God avenges himself by allowing the ever-deepening decline of evil men and women. That is what we see today all around us—men and women have slipped to such depths that it would disgrace animals to have such conduct among them. God's wrath is all around us, and it seems that more wrath (God's giving people up to sin) is falling daily.

Frank Thielman: The form in which God's wrath is being revealed against this ongoing rebellion, moreover, is itself just, since it is commensurate with the crime. Just as it was irrational not to conclude from the creation that a powerful, eternal God was its maker and instead to claim in effect that creatures made themselves, so God's punishment of this rebellion affected the ability of human beings to think clearly about God, his creatures, and how they

should relate to one another. They became “*futile*” in their reasoning powers and “*their foolish heart was darkened*” (1:21). They called foolishness wisdom (1:22) and traded the truth for a lie (1:25). They refused to give God their stamp of approval, and so God gave them minds that could not distinguish between the worthwhile and the worthless (1:28).

This inability to think in accord with the truth about God, his creation, and the way creatures should relate to one another worked itself out in practical terms in a wide variety of social ills. Paul probably highlighted homoerotic sexual activity because it was such a clear example of human beings, blinded by passion, engaging in activity that was contrary to nature and ended in dishonor and futility. The social ills Paul fires off in rapid succession in 1:29–31, similarly, describe a society that does not function because its individual members are blinded by their own passions and have therefore lost the ability to think clearly and act rationally for the good of the whole. In summary, human beings have suppressed the truth about God; this has led to impiety and unrighteousness; and the unrighteousness is itself the outpouring of God’s wrath in the present on those who richly deserve precisely this punishment (1:18).

I. (:24-25) SEXUAL IMPURITY IS GOD’S JUDGMENT FOR IDOLATRY

A. (:24) How Did God Judge Them? Sexual Impurity

“Therefore God gave them over in the lusts of their hearts to impurity, that their bodies might be dishonored among them.”

Frank Thielman: The term “*therefore*” (διό) reaches back to the entire section stretching from 1:19 to 1:23 with its description of why God reveals his wrath against humanity. Now Paul describes how God reveals his wrath, and, again, the focus lies on the fairness of the punishment. Not only does the crime merit punishment, but it merits precisely the punishment God gives. God hands people over to the consequences of their knowing refusal to acknowledge him as God. . .

The expression “*to hand someone over to something*” was often used in **judicial contexts** (e.g., **Matt 10:17; 20:19; 24:9; Luke 21:12; 24:20; Acts 8:3**), and so Paul assumed that the punishment he described here was a judicial punishment. Paul pictures God as a just judge giving to people precisely what they deserve. He could use the terms “*lust*” (ἐπιθυμία) and “*uncleanness*” (ἀκαθαρσία) together elsewhere with sexual connotations (**Gal 5:16, 19, 24; Eph 4:19, 22; Col 3:5; 1 Thess 4:5, 7**), and as 1:26–27 shows they carry those connotations here. . .

The uncleanness to which God has handed over idolatrous human beings is specifically the mutual **dishonoring** of their bodies. Here, too, the fairness of God’s punishment is clear: just as they have dishonored him, so he has handed them over to their dishonorable conduct toward one another.

Grant Osborne: Why is sexual sin so powerful? The Bible frequently urges believers to avoid sexual sin. Did God, the creator of sex, decide he had made a mistake? Definitely not! God invented sex as a pleasurable part of the unique relationship between women and men, who are made in his image. Like most gifts, sex has proper and improper uses. What was created to be an expression of fidelity, intimacy, comfort, and sheer pleasure can also be the expression of

selfishness, betrayal, deception, and manipulation. In its rightful place sex builds self-worth and deepens intimacy. Used wrongfully, it destroys people and relationships, undermining trust and acceptance. Sex is a wonderful gift to be shared by those for whom God designed it.

Because sex is such a powerful and essential part of what it means to be human, it must be treated with great respect. Sexual desires are of such importance that the Bible gives them special attention and counsels more careful restraint and self-control than with any other desire. One of the clearest indicators of a society or person in rebellion against God is the rejection of God's guidelines for the use of sex.

James Dunn: Paul would see the act of handing over as **punitive**, but not as spiteful or vengeful. For him it is simply the case that man apart from God regresses to a lower level of animality. God has handed them over in the sense that he has accepted the fact of man's rebellious desire to be free of God (in terms of **Gen 3**, to be "*as God*"), and has let go of the control which restrained them from their baser instincts. The rationale is, presumably, that God does not retain control over those who do not desire it; he who wants to be on his own is granted his wish.

Thomas Constable: The third characteristic of humankind in rebellion against God that Paul identified—after ignorance (v. 21) and idolatry (v. 23)—is impurity (v. 24). Here Paul evidently had natural forms of moral uncleanness in view such as adultery and prostitution. He went on in **verses 26-27** to describe even worse immorality, namely, unnatural acts such as homosexuality. "*Natural*" here means in keeping with how God has designed people, and "*unnatural*" refers to behavior that is contrary to how God has made us.

B. (:25) How Did They Abandon the Truth? Delusion and Idolatry

1. Delusion = Exchanged the Truth of God for a Lie

“For they exchanged the truth of God for a lie,”

Frank Thielman: The verb “*exchanged*” (μετήλλαξαν) is repeated from **1:23** (ἤλλαξαν), but now with a preposition (μετά) that **intensifies** its meaning: people completely abandoned the truth God had revealed to them about himself (**1:19–20**). God revealed the truth about himself as Creator to them, but they knowingly exchanged this truth for a lie—the lie that the images they “*revered and served*” were actually gods who would respond to their worship with salvation and blessing. This was a common Jewish view of non-Jewish religious practices (e.g., **Isa 44:20; Ep Jer 6:8, 34–38, 47; cf. 1 Cor 8:4; 10:19–20; Gal 4:8**), but they were also practices to which the Jews themselves had sometimes fallen prey (e.g., **Jer 2:26–28**). The thought of idolatry was so **repulsive** to Paul that he utters a common Jewish benediction, praising the Creator in defiance of the idol worship he has just described.

2. Idolatry

*“and worshiped and served the creature rather than the Creator,
who is blessed forever. Amen.”*

Application: How can we tell whether our focus is on God the Creator and heavenly priorities? What would you do with 2 days alone and no responsibility or accountability?

II. (:26-27) HOMOSEXUALITY IS GOD'S JUDGMENT FOR WORSHIPING THE HUMAN BODY

A. (26a, 27b) How Does God Judge Such a Society? Degradation

“For this reason God gave them over to degrading passions;”

“and receiving in their own persons the due penalty of their error.”

Thomas Schreiner: The context suggests that the “penalty” is not something in addition to same-sex sin. The penalty is rather being handed over to the sin of same-sex relations.

James Dunn: Paul would certainly affirm that the typical association between pagan idolatry and sexual license was no accident: the more base the perception of God, the more base the worship and corresponding conduct appropriate to it (cf. Wisd Sol 14:12).

B. How Did They Abandon the Truth? Homosexuality

1. (:26b) Women Rejected Natural Sexual Relations for Unnatural

“for their women exchanged the natural function for that which is unnatural,”

Not a legitimate sexual orientation, but an unnatural perversion that is living proof of God's wrath

R. Kent Hughes: Why does Paul single out homosexuality then? **Because it is so obviously unnatural**, and therefore automatically underlines the extent to which sin takes mankind. Other sins are just as evil, but they are naturally evil. God has emphasized the sin of inversion to show us that inside the unbelieving man is a running sore that indicates a far deeper dimension of the wounds of sinful society.

2. (:27a) Men Rejected Natural Sexual Relations for Unnatural

“and in the same way also the men abandoned the natural function of the woman and burned in their desire toward one another, men with men committing indecent acts”

Thomas Schreiner: It is clear, then, that Paul condemns not just the activity but also same-sex lust, though, of course, such lust translates itself into actions that are shameful.

Frank Thielman: Paul thought that the eternal power and divinity of the Creator were obvious from the physical world and led clearly to the conclusion that people should glorify and thank the Creator (**1:20–21**). In the same way, Paul probably considered the “*natural*” character of heterosexual activity to be obvious from the physical anatomy of male and female and from the role of heterosexual intercourse in the production of children.

When human beings chose to revere and serve the creature rather than the Creator (**1:25**) and irrationally failed to glorify and thank God, their reasoning powers became futile and blurry, and they were shown to be foolish (**1:21–22**). In the same way, Paul considered homoerotic sexual activity to be foolish at an obvious level: it used the human body in a way contrary to its natural

design, and it could accomplish nothing. Because of this, those who engaged in it dishonored themselves, and this is the sense in which they received “*in themselves*” the recompense for their sin. At the level of human relations, this was equivalent to worshiping the creature rather than the Creator (1:25).

Illustration: "You are acting like animals" – but even animals don't stoop to this level of indecency

III. (:28-32) UNRESTRAINED TOTAL DEPRAVITY IS GOD'S JUDGMENT FOR CASTING OFF THE FEAR OF GOD

A. (:28) How Did God Judge Them? Unrestrained Total Depravity --

“And just as they did not see fit to acknowledge God any longer, God gave them over to a depraved mind, to do those things which are not proper,”

Vine: A mind which is reprobate, worthless, useless, is unable to fulfill its natural functions as designed by God; it confuses right and wrong, failing to distinguish what is pleasing to Him from what is displeasing.

B. (:29-32) How Did They Abandon the Truth? Smorgasbord of Sins

1. (:29-31) Practice of All Kinds of Sin

“being filled with all unrighteousness, wickedness, greed, evil; full of envy, murder, strife, deceit, malice; they are gossips, 30 slanderers, haters of God, insolent, arrogant, boastful, inventors of evil, disobedient to parents, 31 without understanding, untrustworthy, unloving, unmerciful;”

Grant Osborne: Every Kind of Wickedness

- **Evil**—What is sinister and vile. Greed—Relentless urge to get more for oneself.
- **Depravity**—A condition of moral evil.
- **Envy**—Desire for something possessed by another.
- **Murder**—Greed, envy, and strife, left unchecked, could lead even to killing another in order to obtain what is desired.
- **Strife**—Competition, rivalry, bitter conflict.
- **Deceit**—To trick or mislead by lying.
- **Malice**—Doing evil despite the good that has been received.
- **Gossips**—They create problems by rehashing idle talk or rumors concerning others' private affairs.
- **Slanderers**—Destroy another's good reputation.
- **God-haters**—Not only do they ignore God; some actively hate him and attempt to work against any of his influences.
- **Insolent**—Arrogant behavior toward those who are not powerful enough to fight back. This particularly refers to a person's attempt to shame another without mercy.
- **Arrogant and boastful**—Making claims of superior intelligence or importance.
- **Invent ways of doing evil**—Trying new kinds of perversions.
- **Disobey their parents**—When God's authority is tossed aside as worthless, parental authority cannot be far behind. How unfortunate that the parents, in many cases, had set

the example. By ignoring God's authority, they set the example for the children to ignore parental authority.

- **Senseless**—Unable to discern spiritual and moral things.
- **Faithless**—Unfeeling, unkind, harsh, cruel.
- **Ruthless**—Without pity or compassion; merciless.

Timothy Keller: Romans 1:28-32 is unsettling because, as we've already seen, all of us find ourselves there, one way or another. This is not an exhaustive list of the outworkings of idolatry—of not thinking it "*worthwhile to retain the knowledge of God*" (v 28)—but it is a wide-ranging one. Here we have economic disorder ("*greed*," v 29); social disorder ("*murder, strife, deceit and malice*," v 29); family breakdown ("*they disobey their parents*," v 30); relational breakdown ("*senseless, faithless, heartless, ruthless*," v 31). This is what theologians call the doctrine of **total depravity**: while not everything we do is always completely sinful, **nothing we do is completely untouched by sin.**

2. (:32) Celebration of All Kinds of Sin

"and, although they know the ordinance of God, that those who practice such things are worthy of death, they not only do the same, but also give hearty approval to those who practice them."

You either value God's light or you ignore it and become your own guide thru life.

Thomas Constable: The final step down in human degradation is people's promotion of wickedness (v. 32). It is bad to practice these things, but it is even worse to encourage others to practice them.

James Dunn: It is this character of so much of man's social relations, as deliberate rejection of what is known to be best, as willful rebellion against God's ordering of things, which Paul reemphasizes with one final flourish. "*They not only do such things but give their approval to those who do so too.*" Their rejection of God is not merely a spur of the moment, heat of the instant flouting of his authority, but a considered and measured act of defiance. This is an important insight into one aspect of human sinfulness—its character of rebellion against what is known to be right (or best) its act of defiance in the face of known and perilous consequences of the act, its seemingly heroic "I/we will do what I/we will do and damn the outcome!" The miserable list of antisocial behavior (vv 29–31) illustrates just what human wisdom in its vaunted independence from God ends up justifying to itself (it would not be difficult to extend the list with twentieth-century examples). It is such self-delusion which lies at the heart of so much human conduct. And precisely because it is self-delusion, a self-destructive and society-destructive delusion, Paul attacks it so fiercely as the opening argument of his broader indictment.

CONCLUSION:

If we insist on living an immoral life that we know is opposed by God (or if a society does so), we are in danger of God abandoning us

- Illustration: looting during heavy snowstorm manifests how inner depravity manifests itself once restraints are removed.
- Illustration: removing grass from a hillside leads to erosion and a mudslide.
- Illustration: society operates like a Yo-Yo; we drift down and then recover for awhile; the danger is God might cut the string.

* * * * *

DEVOTIONAL QUESTIONS:

- 1) What are the characteristics of a reprobate mind?
- 2) Where do you see society calling good evil and evil good?
- 3) What is the significance of our society degenerating to the point that people are not only pressured to tolerate immoral practices but forced to actually celebrate them?
- 4) Are you growing in your hatred of those sins that reflect a rejection of God's truth while still showing mercy towards sinners and avoiding the pitfall of self-righteousness?

* * * * *

QUOTES FOR REFLECTION:

Timothy Keller: Recently, many have attempted to suggest that the traditional understanding of these verses is mistaken; that this refers to people who act against their own nature; or that it refers only to promiscuous homosexual sex, and not to long-term settled relationships. But "*unnatural relations*" (v **26, 27**) is literally "*against nature*"—*para phusin*. This means that homosexuality is a violation of the created nature God gave us. And there is nothing here to suggest that Paul only has some kinds of homosexual acts in mind. As a cultured and traveled Roman citizen, Paul would have been very familiar with long-term, stable, loving relationships between same-sex couples. That does not stop him from identifying them as not the Creator's intention for human flourishing.

Charles Ryrie: Notice the words Paul uses to describe lesbianism and homosexuality: '*degrading*,' '*unnatural*,' '*indecent*.' Even though homosexuals and lesbians say that such conduct is not degrading or unnatural, that does not change the character of these sins in God's eyes. Lesbianism and homosexuality are in themselves wrong.

Until 1973 homosexuality was on the American Psychiatric Association's list of **mental disorders**, but it was removed that year. Defenders of the movement tell us that homosexuality should no longer be considered a deviant lifestyle but rather an **alternative lifestyle**. It has even

been compared to left-handedness in an effort to make it morally neutral and therefore acceptable.

David Malick: A contextual and exegetical examination of **Romans 1:26-27** reveals that attempts by some contemporary writers to do away with Paul's prohibitions against present-day same-sex relations are false. Paul did not impose Jewish customs and rules on his readers; instead he addressed same-sex relations from the transcultural perspective of God's created order. God's punishment for sin is rooted in a sinful reversal of the created order. Nor was homosexuality simply a sin practiced by idolaters in Paul's day; it was a distorting consequence of the fall of the human race in the Garden of Eden. Neither did Paul describe homosexual acts by heterosexuals. Instead he wrote that homosexual activity was an exchange of the created order (heterosexuality) for a talionic [equal in kind] perversion (homosexuality), which is never presented in Scripture as an acceptable norm for sexuality. Also Hellenistic pederasty [sexual activity involving a man and a boy] does not fully account for the terms and logic of **Romans 1:26-27** which refers to adult-adult mutuality. Therefore it is clear that in **Romans 1:26-27** Paul **condemned homosexuality as a perversion of God's design for human sexual relations.**

R. Kent Hughes: I would also offer a brief word to those who are involved in homosexual inversion. **It is not a sickness, but a sin**, and that ought to be encouraging because there is a remedy for sin, whereas many sicknesses have no cure. The Scriptures indicate that homosexuality is a sin from which one can recover.

Or do you not know that the unrighteous will not inherit the kingdom of God? Do not be deceived: neither the sexually immoral, nor idolaters, nor adulterers, nor men who practice homosexuality, nor thieves, nor the greedy, nor drunkards, nor revilers, nor swindlers will inherit the kingdom of God. And such were some of you. But you were washed, you were sanctified, you were justified in the name of the Lord Jesus Christ and by the Spirit of our God. (1 Corinthians 6:9–11)

Some of the Corinthians were previously homosexuals, drunkards, thieves, but they were “washed”—cleansed.

Paul also emphasized this sin because it was all around him. He was writing from Corinth, the sin capital of Asia. Greek culture taught that homosexual love was the purest and highest of loves. Many highborn Greeks maintained male lovers along with their wives. It was no different in Rome. Fourteen of the first fifteen emperors were homosexuals. Sounds like today, does it not? **Romans 1** describes any major city in the world today: Hong Kong, San Francisco, Vienna, Zagreb, Berlin, New York, Tokyo, Chicago.

Grant Osborne: Here are some questions to help you see if your attitudes are like **idolatry**.

- Who created you?
- Whom do you ultimately trust?
- To whom do you look for ultimate truth?
- To whom do you look for security and happiness?
- Who is in charge of your future?
- What do you think you can't live without?

- Who do you think you can't live without?
- What priority in your life is greater than God?
- What dream would you sacrifice everything to realize?
- Does God have first place in your life?

Steven Cole: Going Down, Down, Down

If you were born after 1970, you may not realize how drastically America and the West changed during the 1960's. I grew up in the 1950's watching TV shows like "Ozzie and Harriet," "Leave it to Beaver," and "Father Knows Best," all of which depicted the typical American family. The father wore a suit, supported the family, and was looked to as the head of the home. The mother wore a dress, prepared the meals, and dispensed wisdom to the kids to help them navigate life's normal struggles. There was not a hint of sexual immorality, whether with the parents or kids. A kiss between a teen boy and girl was about as far as things went for the kids. There were no references to drugs. It was pretty radical when Ricky Nelson formed a rock band, even though their music was pretty tame compared to today's standards. . .

We've gone down a long ways from the 1950's! Some would say that because of these flagrant sins, America is on the brink of God's judgment. But Paul would say, "No, America is *already* under God's judgment." When a society flaunts and gives hearty approval to such sins, even applauding them as right, it shows that God has already given that society over to impurity, to degrading passions, and to a depraved mind. . .

One aspect of God's wrath is to give sinners over to their lusts, so that they experience the inevitable, horrible consequences of sin. That is to say, sin itself is its own punishment! People think that sin will bring them fulfillment and happiness. It may feel good in the short run. But God has designed His moral laws so that if you break them individually or if a society casts them off collectively, those laws turn around and break you! It's like the law of gravity: you can break it, but then it breaks you. . .

Paul here makes two main points:

(1) The root sin is to reject the truth of God and to worship the creature rather than the Creator (1:25).

(2) When people reject God, He gives them over to their sins and the horrible consequences (1:24, 26-32). He shows this judgment three times by stating, "*God gave them over*" (1:24, 26, 28).

- First, God gave them over to **impurity**;
- second, He gave them over to the **degrading passions of homosexuality**;
- third He gave them over to a **depraved mind**, expressed in all sorts of socially destructive sins.

Leedy Greek NT Diagrams:

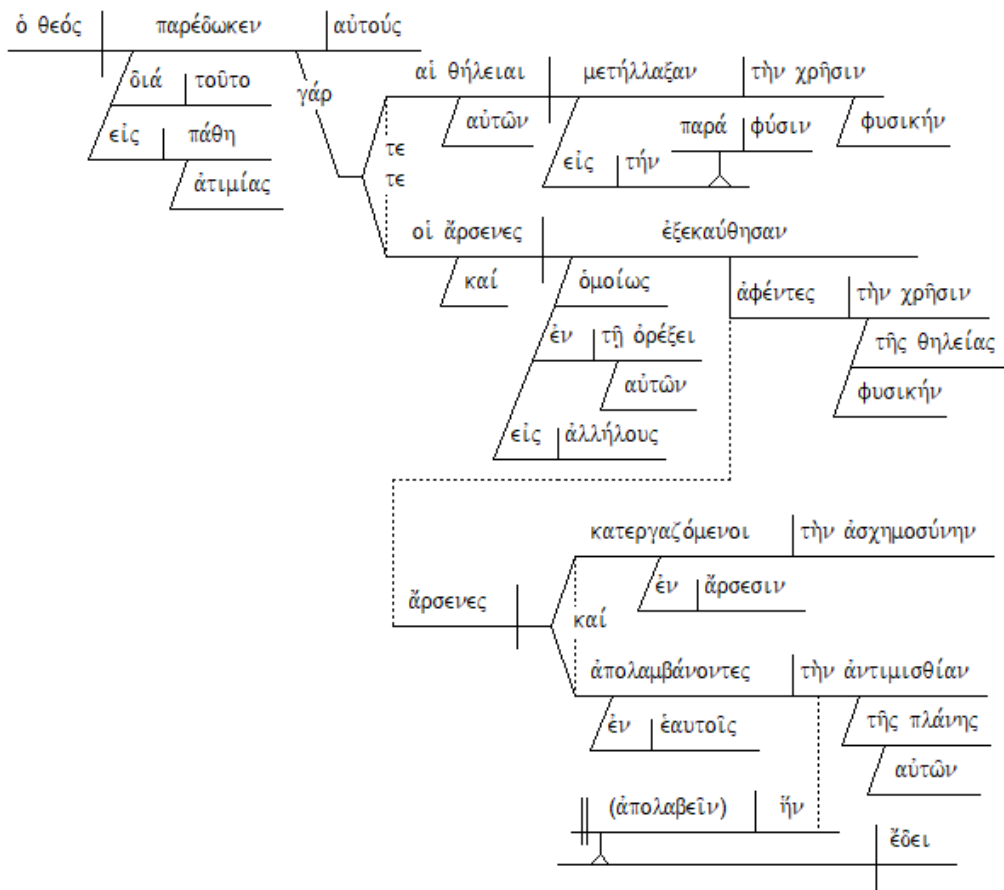
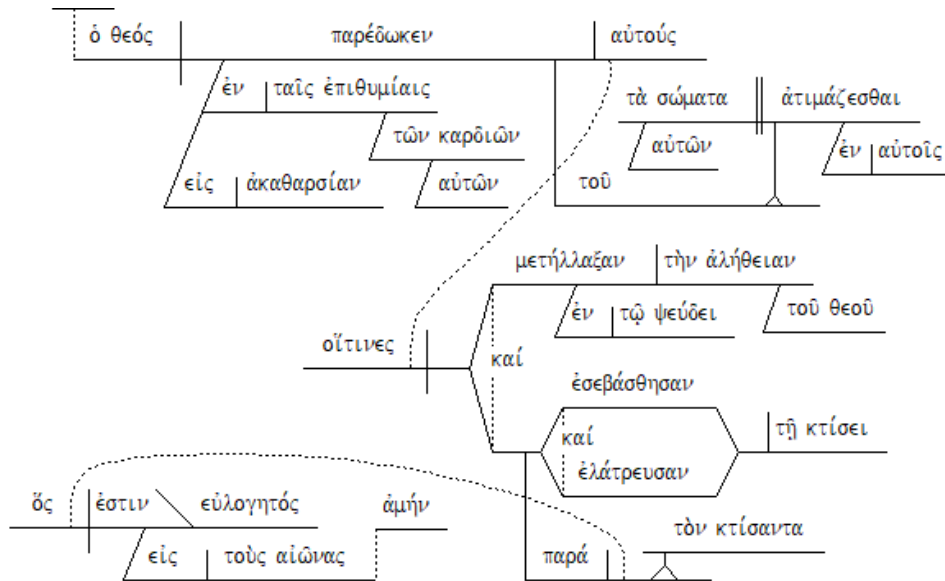

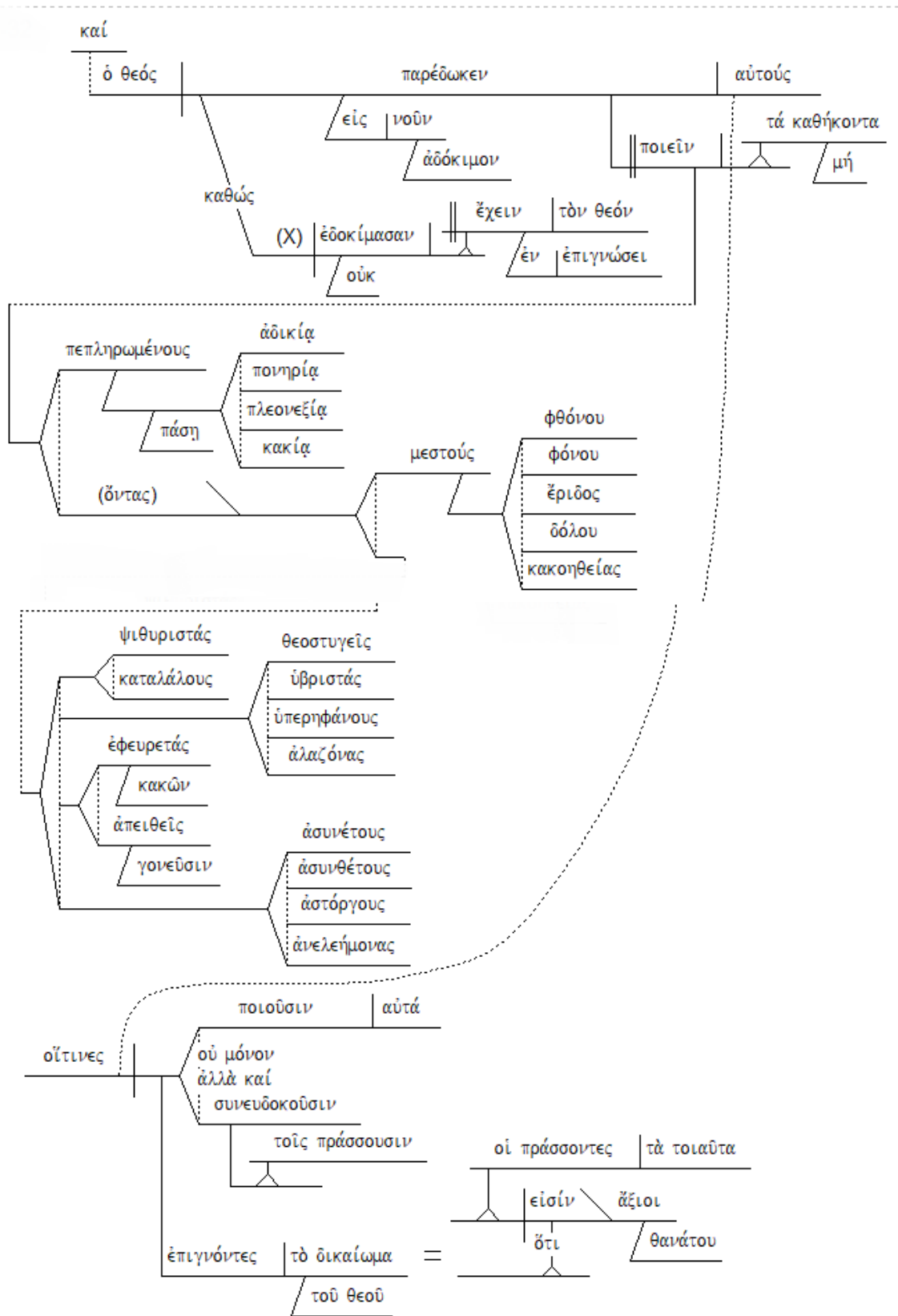

Frank Thielman:

- 24a Result Therefore, **God handed them over**
b Simultaneous in the lusts of their hearts
c Object to the uncleanness
d Description of the dishonoring of their bodies among themselves.
- 25a Basis **They exchanged the truth that came from God**
b Contrast for a lie
c Expansion and **revered and served** the creature rather than
d the Creator,
e Description who is blessed forever, amen.
- 26a Basis of 25a–c Because of this **God handed them over** to dishonorable passions
b Explanation of 26a for, the fact is, **their females exchanged their natural sexual role**
c Contrast for a sexual role contrary to nature.
- 27a Parallel And **males, likewise,**
b abandoned the natural sexual role of the female and
c Contrast **burned in their strong desire for one another,**
d Explanation males with males "accomplishing" what is obscene and
e receiving by way of return the recompense
f Sphere in themselves
g Explanation that was necessary <
h for their error.

<p>28a b Assertion c Sphere d</p>	<p>And just as they did not deem it worthwhile to acknowledge God, God handed them over to a worthless mind, to do things that are not fitting,</p>	<p>filled with all [1] unrighteousness, [2] cunning, [3] greed, [4] malice; full of [5] envy, [6] murder, [7] strife, [8] treachery, [9] mean-spiritedness, [10] rumormongers, [11] slanderers, [12] God-detesting, [13] bullies, [14] arrogant, [15] braggarts, [16] contrivers of evil, [17] disobedient to parents, [18] senseless, [19] faithless, [20] heartless, [21] ruthless.</p>
<p>29a Description List b Description List</p>		
<p>c Description, List 30</p>		
<p>31</p>		
<p>32a Concession b Content c Assertion</p>	<p>Although they know full well they not only do them but also applaud those who practice them.</p>	<p>the righteous decree of God that those who practice such things are ζ worthy of death,</p>

TEXT: ROMANS 2:1-16

TITLE: *GOOD IS NEVER GOOD ENOUGH . . . JEWISHNESS PROVIDES NO FREE PASS*

BIG IDEA:

HYPOCRITICAL HUMANITY (RELIGIOUS MORALIZERS) CANNOT ESCAPE GOD'S IMPARTIAL RIGHTEOUS JUDGMENT

INTRODUCTION:

Frank Thielman: In Romans, Paul wants to show that the gospel is for everyone without exception. He is obligated to proclaim the gospel to Greeks, to barbarians, to wise, to the unlearned—and to Jews. If the good news of God's saving righteousness in Jesus Christ is for everyone, then the bad news that all stand under condemnation apart from God's righteousness is also for everyone. Thus, in **1:18–32** Paul explained that God is revealing his wrath against all humanity for its ungodliness and unrighteousness. Paul explained this in such a way, however, that some Jewish unbelievers might well assume he was only describing gentiles, not Jews. . .

In **Romans 2:1–29**, therefore, Paul wants to show that the good news of God's saving righteousness is not merely for impious and wicked gentiles but for Jews also, because they stand as much in need of God's saving power as gentiles. Paul does this by emphasizing God's fairness in judging the whole world impartially, Jews included. It is not enough to condemn evil, to possess the Mosaic law, to teach the law to others, or to carry the physical mark of circumcision in order to avoid God's wrath and receive eternal life on the final day. As an impartial judge, God focuses on what one does, not on the social group to which one belongs. . .

Paul exposes as unbiblical and un-Jewish his interlocutor's hardhearted attitude toward his own sin and God's mercy. His interlocutor, like the gentile, is unrighteous, and since God is an impartial judge the interlocutor stands as firmly under the sentence of condemnation as any gentile. . .

Here Paul explains that doing what is good, not merely condemning those who are bad, will count on the day of judgment, and the doing, not the hearing of God's law, leads to justification on that day. Paul demonstrates this in the service of his overall point that God will not favor Jews over gentiles on the day of judgment but will treat all in the same way, condemning the wicked among the Jews just as he condemns the wicked among the gentiles.

Michael Gorman: It becomes clear here that **hypocrisy** and **presumption** are as serious as any evil listed in **1:18–32**, for what is at stake is the interlocutor's future justification—here meaning acquittal at the eschatological divine court on judgment day (**2:5, 13, 16**) and reception of life eternal (**2:7**). It also becomes clear in this passage, as in **1:18–32**, that the entire person being described is out of sync with God: body/deeds, mind/imagination (**2:3**), and heart (**2:5**). We will see later in the chapter (**2:25–29**) that the heart is the heart of the problem. . .

In summary: just as the divine gospel is for Jew and gentile alike, so also is the divine criterion of judgment: performance, not possession, of God's law.

Douglas Moo: To be sure, Paul does not directly address his "opponent" as a Jew until **2:17**. But the language he uses in **verses 1–5** points unmistakably to a **Jewish situation**. Paul has shown in **1:21–32** that Gentiles have suppressed the truth that God revealed to them in nature and they therefore have "*no excuse*" before God. He now begins to show that Jews also suppress the truth God has given them and that they, too, are "*without excuse*."

Paul's argument in these verses develops in two clear stages, marked by a shift from the second person (vv. 1–5) to the third person (vv. 6–11).

- In the former paragraph, he exposes as false the Jews' presumption of superiority over the Gentile.

In the latter, he sets forth the theoretical basis for this exposé, arguing that God assesses all people on the same basis.

Charles Simeon: Paul is countering the pervasive Jewish view that no Jew could perish, except through apostasy or idolatry; and that no Gentile could be saved, but by subjecting himself to the institutions and observances of the Mosaic ritual (*Expository Outlines on the Whole Bible* [Zondervan], 15:36).

Thomas Schreiner: God's Impartial Judgment -- The argument proceeds in three movements:

(1) The Jews, despite their covenant with God, cannot shield themselves from God's wrath by appealing to his grace (**2:1–5**). God judges all people according to what they have done, and the Jews will be judged, since they have sinned.

(2) God does not grant his rewards to the Jews merely because of their Jewish heritage (**2:6–11**). God judges on an impartial basis, and therefore the one who does good works (whether Jew or gentile) will be rewarded with eternal life, whereas the one who does evil will face God's eschatological wrath.

(3) Jews cannot appeal to the mere possession of the Torah as a saving advantage (**2:12–16**). Vindication on the last day comes from keeping the law, not merely by having it. All those who violate God's commands will perish on the final day.

I. (:1-4) NO POSSIBLE EXCUSES OR ESCAPE FROM GOD'S RIGHTEOUS JUDGMENT

A. (:1) No Excuses Because Your Conduct Condemns You as You Judge Others

"Therefore you are without excuse, every man of you who passes judgment, for in that you judge another, you condemn yourself; for you who judge practice the same things."

Illustration: **2 Samuel 12** – Incident of the prophet Nathan confronting David with his sin

We stand condemned by our own moral evaluations of right and wrong. Paul does not try to argue that they are greater sinners but rather that they stand condemned by whatever standard of morality they apply to others. Since they are hypocrites, their guilt is even greater.

Frank Thielman: Who is this person? Paul becomes more explicit about his identity in **2:12, 17, 23,** and 25. He is addressing a Jew who possesses the Mosaic law, the ethical and legal code of Israel that separates them from the nations. Sometimes Paul's interlocutor believes that he is basically obedient to the law, and Paul seeks to show him that he too is a sinner (**2:1–3b, 17–24**). Yet most of Paul's argument assumes that his interlocutor expects God to hold him to a different standard than the gentiles. He thinks God will condemn the unrighteous among the gentiles to the death they deserve (**1:32**) but will treat his own people Israel more leniently because of his covenant with them.

David Guzik: After gaining the agreement of the moralist in condemning the obvious sinner, now Paul turns the same argument upon the moralist himself. This is because at the end of it all, you who judge practice the same things.

James Dunn: The list of **1:29–31** largely consists of vices into which an individual can slide without being fully aware of it. In particular, the last five items are applicable to the sort of attitude among the Pharisees already criticized within the Jesus tradition (**Mark 7:9–13**; cf. also **Mark 7:21–22** with **Rom 1:29–31**). The prominence given in that list to sins of **pride** and **presumption** (ὕβριστας, ὑπερηφάνους, ἀλαζόνας) may well already have had the **Jewish interlocutor** in mind, since it is precisely Jewish presumption regarding their favored status as the people of God which underlay so much Jewish disparagement of Gentile religion.

Timothy Keller: **2:1** comes as a bucket of cold water to the religious person. It is an absolute masterstroke. Paul turns to the person who has been sitting and listening to his exposé of pagan lifestyles in chapter 1, and feeling pleased that they are not like “them.” Paul says: You do the same things! Whenever you judge a non-religious person, you are judging yourself! It turns out that the end of **chapter 1** is written to expose the idols of the religious person as much as those of the irreligious person.

John Murray: Now in the case of the Jew Paul's indictment presupposes the thing that was absent in the case of the Gentiles, namely, a condemnatory judgment of others for sins committed. It is to be noted, however, that the indictment brought against the Jew is not that he judged others for sins committed; it is rather that he judged others for the very things he practised himself. In other words, it is the **blindness** and **hypocrisy** of the Jew, hypocrisy because he judged others for the same sins of which he himself was guilty, blindness because he failed to see his own self-condemnation in the condemnation he pronounced on others. The state of mind characterized by hypocrisy and blindness is brought home not in these express terms but in the form of the charge of inexcusableness and in this respect the Jew is placed in the same category as the Gentile.

Steven Cole: Illustration -- A man complained about the amount of time his family spent in front of the TV. His girls watched cartoons and neglected schoolwork. His wife preferred soap operas to housework. His solution? “As soon as the baseball season's over, I'm going to pull the plug” (*Reader's Digest*, June, 1981, p. 99). How easy it is to fall into this deadly sin of **self-righteousness!**

B. (:2) No Excuses or Escape Because God’s Judgment Is Righteous and Certain

“And we know that the judgment of God rightly falls upon those who practice such things.”

We stand condemned by God who knows all and judges us objectively based on our conduct.

Frank Thielman: God, who sees into the human heart (cf. **2:16**), has no trouble piercing through the hypocrisy of those who condemn others for the same conduct that they “*practice*” (πρασσοντας; cf. 1:32). The negative verdict he renders (κρίμα) matches the truth of what the defendant has done (cf. **2:5–6**). This strict truthfulness stands in contrast to human thinking, which suppresses the truth that it knows about God and exchanges it for a lie (**1:18, 25**).

Grant Osborne: Paul assumes that all his readers will agree with him regarding God’s judgment. Human judgment is based on prejudice and partial perception; God’s judgment is based on the truth—he judges on the basis of the facts about what we do. We know only in part, but God knows fully. Whereas our judgment of others is imperfect and partial, his is perfect and impartial.

C. (:3-4) No Escape Because God Requires Repentance

1. (:3) False Presumption that You Will Escape Judgment

*“And do you suppose this, O man,
when you pass judgment upon those who practice such things
and do the same yourself,
that you will escape the judgment of God?”*

Why would people think that they are exempt from God’s judgment?

Frank Thielman: Paul asks his interlocutor if he thinks that somehow he is an exception to the rule of God’s impartial judgment. The conclusion should be obvious: he is not an exception.

James Dunn: Paul implies also that Jewish pride in the law (**2:17–20**) obscured the degree to which Jews themselves failed to “do” the law (**2:21–29**).

John Murray: The impossibility of leniency resides in the fact that the judgment of God is according to truth and therefore knows no respect of persons.

2. (:4) False Presumption that God Will Keep Delaying Judgment

*“Or do you think lightly of the riches
of His kindness and forbearance and patience,
not knowing that the kindness of God leads you to repentance?”*

God’s kind forbearance should not be interpreted as a stay of execution but as an invitation to repentance.

Frank Thielman: In **2:1b–5** Paul assumes that his fictional interlocutor has joined him in condemning the ungodly and unrighteous people of **1:18–32**. He points out that having such an

attitude toward others at the same time that one is oblivious to one's own sin and impending judgment reveals a heart hardened toward God's kindness, forbearance, and patience, and positions one directly underneath the Damocles's sword of God's coming wrath.

In **2:6–11** Paul explains how he can say this with such assurance and why his interlocutor should agree with him: they both know that God is an impartial judge. Paul states this principle at the beginning (**2:6**) and end of this paragraph (**2:11**) in language that echoes the biblical text that both he and his interlocutor accept as authoritative. Sandwiched between these two expressions of the principle is a carefully arranged explanation of it. Paul first explains the principle simply from the perspective of the “works” that form the criterion of God's judgment, using both positive (**2:7**) and negative (**2:8**) expressions. He then explains the principle from the same perspective but with the issue of ethnicity introduced, and again uses positive (**2:10**) and negative expressions (**2:9**), this time in reverse order. The whole paragraph follows a chiasmic pattern and progresses from a simple statement of God's impartial judgment according to works to the more specific point that God's impartiality implies the exclusion of ethnicity as a criterion of God's judgment.

Douglas Moo: Relying on “*the riches of [God's] kindness, tolerance and patience*” to avoid judgment will not work (**vv. 3–4**). These words together connote God's grace and willingness to forgive. “*Kindness*” (chrestotes) occurs again in Romans in **11:22**, where it is the opposite of God's “*sternness*,” and it appears regularly in the Psalms to denote God's goodness to Israel. “*Tolerance*” (anochē) occurs in only one other place in the New Testament, where it refers again to God's “*forbearance*” (**Rom. 3:25**). Paul's use of this language suggests he is thinking at this point of the Jewish people. For we must remember that the Jews' assumption of superiority over Gentiles was not a matter of ego or personal boasting. Out of all the nations of the earth, God had chosen Israel as his people. Surely, Jews may well have reasoned, as God's chosen people, they are immune from judgment—his “*tolerance*” and “*kindness*” will always cause him to overlook our sins.

R. Kent Hughes: So we see the **psychology of the self-righteous**: their ignorance of the nature and extent of sin, blindness to their own sins, extreme judgmentalism, siding with God against others' sins, interpreting God's kindness as approval. God understands those who are truly self-righteous. **He is never fooled.** That is why his judgment will be rendered with unerring, terrible perfection. **He sees all.** In **Psalm 139:4** David says, “*Even before a word is on my tongue, behold, O LORD, you know it altogether.*” God knows the real intention behind every spoken word. God knows instantly and effortlessly everything about us. A man may be a “good” person—upright, outwardly moral, sure of his goodness. But if he dies without Christ, Christ will say to him, “*You have no excuse*” (**Romans 2:1**). And his judgment will be perfect.

John Murray: The abundance of God's “*forbearance and longsuffering*” to Israel was exemplified again and again in the history of the Old Testament but the apostle must be thinking particularly, if not exclusively, of the forbearance and longsuffering exercised to the Jew at the time of writing. For in the rejection of the grace and goodness manifested in Christ the Jew had given the utmost of ground for the execution of God's wrath and punishment to the uttermost. Only “*the riches*” of forbearance and longsuffering could explain the preservation accorded to him. We must not press unduly and thus artificially the distinction between “*forbearance*” and

“*longsuffering*”. Together they express the idea that God suspends the infliction of punishment and restrains the execution of his wrath. When he exercises forbearance and longsuffering he does not avenge sin in the instant execution of wrath. Forbearance and longsuffering, therefore, reflect upon the wrath and punishment which sin deserves and refer to the restraint exercised by God in the infliction of sin’s desert. It needs to be noted that the apostle does not think of this restraint as exercised in abstraction from the riches of God’s goodness, the riches of his benignity and lovingkindness. There is a complementation that bespeaks the magnitude of God’s kindness and of which the gifts of covenant privilege are the expression. . .

To “*despise*” is to underestimate the significance of something, to think lightly of it and thus fail to accord to it the esteem that is due. It can also take on the strength of scorning and contemning. The Jew whom Paul is addressing had indeed failed to assess the riches of goodness of which he was the beneficiary, and whenever God’s gifts are underestimated they are truly despised. However, when we think of the unbelief with which the apostle is dealing as that of a Jew who had rejected the revelation of grace in Christ, we must predicate of him contempt and scorn in the most express and direct fashion. It is in these terms that we shall have to interpret Paul’s question. . .

The presumptuous Jew interpreted the special goodness of God to him as the guarantee of immunity from the criteria by which other men would be judged and he claimed for himself indulgence on the part of God; the Gentile needed repentance but not he. What the apostle says is that the goodness of God when properly assessed leads to repentance; it is calculated to induce repentance, the frame of mind which the Jew considered to be the need only of the Gentile. The goodness of God has not only this as its true intent and purpose; when properly understood this is its invariable effect. And the condemnation of the Jew is that he failed to understand this simple lesson.

II. (:5-11) NO PARTIALITY IN GOD’S RIGHTEOUS JUDGMENT

Chiastic Structure: A (:6) B (:7) C (:8) C1 (:9) B1 (:10) A1 (:11)

Douglas Moo: Sometimes in a chiasm, the main point comes at the center. In this case, however, the main point appears at the outer edges. [Although the center thought – wrath for those who do evil – could also be said to be the key]

A. (:5-6) Judgment Will Be Consistent with One’s Conduct

1. (:5) Accumulating Storehouse of Future Wrath

*“But because of your stubbornness and unrepentant heart
you are storing up wrath for yourself
in the day of wrath and revelation of the righteous judgment of God,”*

Steven Tackett: Let us define hardness and impenitent heart. It is fixed and unchanging; it is unwilling to show sorrow and remorse. In other words, it is an unwillingness to change or repent. It is a resolve to continue rejecting God and what God says.

James Dunn: The pious interlocutor assumes that by his faithfulness to the covenant he is laying up treasure in heaven; but by his failure to recognize the need for a more radical repentance he is actually storing up not “good,” not “life,” but wrath.

2. (:6) Universal Basis for Judgment

“who will render to every man according to his deeds.”

Frank Thielman: In order to demonstrate God’s impartiality, Paul says that in principle God will repay eternal life to those whose good works merit it (2:6, 10, 13), but he does not mean that anyone will actually receive eternal life in this way.

John Murray: Verse 6 enunciates three features of God’s righteous judgment:

- (1) the universality—“*to each one*”, a fact reiterated in **verses 9, 10**;
- (2) the criterion by which judgment is to be executed—“*according to his works*”;
- (3) the certain and effective distribution of award—“*who will render*”.

B. (:7-10) Two Possible Destinies for God’s Impartial Righteous Judgment

1. (:7-8) Case Study #1

a. (:7) Positive Destiny

“to those who by perseverance in doing good seek for glory and honor and immortality, eternal life;”

John Murray: The three words define **aspiration** in terms of the highest reaches of Christian hope. The reward of this aspiration is in like manner the eschatology of the believer, “*eternal life*”.

b. (:8) Negative Destiny

“but to those who are selfishly ambitious and do not obey the truth, but obey unrighteousness, wrath and indignation.”

Timothy Keller: Verse 8 then gives us two indicators that a person is not right with God:

- “*Self-seeking*” is the tell-tale sign. It means to have a spirit of self-will, or self-glorification—of seeking to be our own Lord and/or Savior. This is something that can be pursued either through being irreligious and licentious, or through being moral, religious and upright.
- “*Reject the truth and follow evil*” means there is an unwillingness to be instructed and learn from God’s truth. There is a lack of teachability, a refusal to submit to truth outside one’s own convictions and heart. Irreligious people do this in a very obvious way, but religious people do it, too! If we want to think of ourselves as righteous through our law-keeping, we are willing to listen to God’s commands about how to live; but we ignore his word when it tells us that we must keep it perfectly, and that we don’t keep it perfectly, and that we need to be given righteousness that we cannot earn. If we think we can save ourselves, we reject the truth as much as if we think we do not need to be saved at all.

2. (:9-10) Case Study #2

a. (:9) Negative Destiny

“There will be tribulation and distress for every soul of man who does evil, of the Jew first and also of the Greek,”

b. (:10) Positive Destiny

“but glory and honor and peace to every man who does good, to the Jew first and also to the Greek”

Frank Thielman: He now explicitly states what has been his point all along, that the Jew who does evil will not escape God’s condemnation. The day of God’s wrath will reveal his “*righteous judgment*” (2:5), which means that God’s judgment will be fair. The Jew does have priority over the gentile in ways that Paul has hinted at in 1:16 and will explain more fully in 3:2 and 9:1–5, but this priority does not mean that God will judge the Jew in a different way than he judges the gentile.

C. (:11) Judgment Will Be Without Partiality

“For there is no partiality with God.”

John Toews: The phrase “*God does not show the face*” is a classic Hebrew assertion of God’s impartiality. “*To show the face*” to one person, but not another, is to show partiality. God does not show the face to anyone. . . Impartiality is the ground for God’s righteousness. Because this righteousness excludes partiality, God judges all people and makes righteous all people “*without distinction.*” Therefore, people are called to live justly without regard for the ethnic identity or social status of others.

John Murray: The criterion of judgment is not privilege or position but that affirmed repeatedly in the preceding verses, namely, **the character of men’s works**. It might appear that the priority accorded to the Jew in **verses 9, 10** is inconsistent with the principle that there is no respect of persons with God. But it is to be remembered that the priority accorded to the Jew gives him no immunity from the criterion of judgment which is applied to all indiscriminately. The determining factor in the awards of retribution or of glory is not the privileged position of the Jew but evil-doing or well-doing respectively. And the priority of the Jew applies to retributive judgment as well as to the award of bliss. As will be noted in connection with **verse 12**, the equity of God’s judgment and the fact that there is no respect of persons with him do not interfere with the diversity of situations which are found among men. Equity of judgment on God’s part takes the diversity of situation into account and hence the priority belonging to the Jew, because of his privilege, accentuates his condemnation in the event of evil-doing just as the righteous judgment of God is verified and most relevantly exemplified in the award of glory in the event of well-doing. It needs to be noted, furthermore, that no greater degree of glory, honour, and peace is represented as bestowed upon the Jew by reason of his priority.

III. (:12-16) NO MERE POSSESSION OF THE LAW OR PLEADING OF IGNORANCE WILL EXEMPT ONE FROM GOD’S RIGHTEOUS JUDGMENT

Frank Thielman: In **2:12–16** Paul introduces the issue of the **Mosaic law** into the argument to explain that Jewish possession of the law does not nullify the principle that God will make no distinction between Jew and gentile on the day of judgment. **Doing the law**, not possessing the law, will lead to justification on that day. Gentiles too have a **moral compass** that functions as a form of God’s law. It sometimes agrees with the Mosaic law and sometimes leads them to righteous conduct. Because of this, God will be able to judge people justly on the final day apart from the question of whether or not they possess the Mosaic law.

Douglas Moo: Paul intends to show here that the Jews’ possession of the law does not give to them a decisive advantage over the Gentiles (**2:12**). He shows this by arguing that

- (1) it is doing, not possessing, the law that counts (**2:13**), and
- (2) even Gentiles have “law” in a certain sense (**2:14–15**).

A. (:12-13) Universal Requirement = Obedience to God’s Law

1. (:12) Obedience Required Regardless of Level of Spiritual Privilege

“For all who have sinned without the Law will also perish without the Law; and all who have sinned under the Law will be judged by the Law;”

Timothy Keller: Paul is saying that God is right to judge those who know the law but have not kept it; and Paul is also warning that God will rightfully judge those who don’t know the law externally—because they know it internally, yet have not kept it.

2. (:13) Obedience Required Regardless of Familiarity with Divine Revelation

“for not the hearers of the Law are just before God, but the doers of the Law will be justified.”

God’s final judgment requires obedience to moral standards that are obvious (not just agreement with those standards).

Key = what have we done with what we know?

Frank Thielman: The law in **2:13** is the Jewish law, the revelation of God’s will that sets the Jews who live by it apart from the gentiles. This means that gentiles cannot fall into the category of “*hearers of the law*.” They fall “*by nature*” (φύσει) outside the boundaries of those who hear the law read Sabbath by Sabbath.

John Murray: The apostle is undoubtedly guarding against that perversion so characteristic of the Jew that the possession of God’s special revelation and of the corresponding privileges would afford immunity from the rigour of the judgment applied to others not thus favoured.

B. (:14-16) Universal Judgment Makes Everyone Accountable Before God

1. (:14-15) Conscience and Inward Moral Deliberations Provide Sufficient Accountability

“For when Gentiles who do not have the Law do instinctively the things of the Law, these, not having the Law, are a law to themselves, 15 in that they show the

work of the Law written in their hearts, their conscience bearing witness, and their thoughts alternately accusing or else defending them,”

Grant Osborne: Some Gentiles who did not know anything about God’s law had moral sensitivity and lived as though following it. They had the **law of conscience**. The knowledge of God’s character was available to them, for they knew within their hearts the difference between right and wrong. Their moral awareness will serve in place of the law to judge them.

Paul does not attempt to prove that people are incapable of any good. His point is that not one of us is capable of **perfect goodness**. At the human level, we all behave more or less in line with the standards of our society. But righteousness is not determined by what most people do, or even by what most people think might be possible for someone who tries very hard. Righteousness is God’s standard, God’s character. Comparisons with others are of no help when we measure ourselves before God’s standard. Ultimately, whatever our background, we will be held accountable by God for our life.

Frank Thielman: When they do what God requires without having the Mosaic law to guide them, gentiles show that they have an instinctive sense of right and wrong. The idea that some people felt instinctively what was right to do and could therefore function as “a law to themselves” (ἐαυτοῖς εἶσιν νόμος) was a traditional Greek philosophical notion by Paul’s time, although it was construed in various ways. **Aristotle** thought that some people were so virtuous they did not need laws, “for they are themselves a law” (αὐτοὶ γὰρ εἶσι νόμος; Politics 1284a 13 [H. Rackham, LCL]). The **Stoics** thought that living virtuously was synonymous with living in accord with nature (Arius Didymus, Epitome of Stoic Ethics 5b3; cf. Aristotle, Rhetoric 1375a; Philo, Joseph 29). **Philo** believed that ethnic tradition could function as an unwritten, willingly obeyed law, which was particularly praiseworthy (On the Special Laws 4.150), and so on. Paul commits himself to none of these specific ideas, but their presence in the ancient literature does show that the general notion of an innate, unwritten law was in the air and that Paul’s use of it here is likely. Paul uses the notion to serve his general point that being a “*hearer of the law*” was not necessary for doing the law, and so being a Jew gave one no advantage over being a gentile on the day of God’s wrath. . .

Paul next introduces two genitive-absolute constructions . . . two further pieces of evidence, in addition to the law written on their hearts, that gentiles have a moral standard to which God justly holds them accountable.

- First, their **conscience** functions as a moral compass. Since the conscience in antiquity referred to a knowledge that one shared with one’s self, it is possible for the conscience to “*bear witness together with*” (συνμαρτυρέω) one’s self, and that is probably Paul’s meaning here. Gentiles have a conscience that is capable of alerting them that what they have done is wrong, or, by the absence of a painful conscience in a given situation, of confirming that their conduct was correct.
- Second, their **moral deliberations** with each other yield accusation and, occasionally, defense of one another. . . the “*thoughts among one another*” to which Paul refers are the reasoned decisions that gentiles make about the moral quality of the actions of others around them. These moral judgments sometimes accuse and sometimes even defend the conduct of others.

John Murray: “*Their conscience bearing witness therewith.*” Conscience must not be identified with “*the work of the law written in their hearts*” for these reasons:

- (1) Conscience is represented as giving **joint witness**. This could not be true if it were the same as that along with which it bears witness.
- (2) Conscience is a **function**; it is the person functioning in the realm of moral discrimination and judgment, the person viewed from the aspect of moral consciousness. The work of the law written in the heart is something ingenerated in our nature, is antecedent to the operations of conscience and the cause of them.
- (3) The precise thought is that the operations of conscience bear witness to the fact that the work of the law is written in the heart. Not only does the doing of the things of the law prove the work of the law written in the heart but the witness of conscience does also. **Hence the distinction between the work of the law and conscience.**

2. (:16) Future Day of Judgment Will Extend to One’s Hidden Secrets

*“on the day when, according to my gospel,
God will judge the secrets of men through Christ Jesus.”*

Frank Thielman: Paul’s gospel teaches that God will judge human beings through the Messiah Jesus, and the future day on which he does that will reveal that God has used no different standard of judgment with the gentiles than he has with the Jews. . . the final day will bring to light the existence of an internal moral standard among the gentiles by which God can judge them, a moral standard that for the purposes of a just judgment is identical to the law that the Jews possess in written form. The God who knows “*the hidden things*” within people will have no trouble judging people by conformity to an internal law (cf. **2:28–29; 1 Cor 4:5**; cf. **1 Kgs 8:39**).

Robert Gundry: As objects of judgment, “*the hidden things of human beings*” recalls “*their hearts*” but also indicates that nothing, whether good or evil, will fail to be judged.

* * * * *

DEVOTIONAL QUESTIONS:

- 1) How do you counter the argument that the Apostle Paul is here preaching justification by works?
- 2) How can you see this passage as especially applicable to the Pharisees of Jesus’ day?
- 3) What sins are you inclined to excuse in yourself while condemning in others?
- 4) How could you use these verses in witnessing to somebody who professes that compared to others they believe that they are good enough to get into heaven?

* * * * *

QUOTES FOR REFLECTION:

Charles Hodge: The object of this chapter is to establish the same charges against the Jews, which had just been proved against the Gentiles; to show that they also were exposed to the wrath of God. It consists of three parts.

- The first contains an exhibition of those simple principles of justice upon which all men are to be judged, **vers. 1-16**.
- The second is an application of these principles to the case of the Jews, **vers. 17-24**.
- The third is an exhibition of the true nature and design of circumcision, intended to show that the Jews could not expect exemption on the ground of that rite, **vers. 25-39**.

Thomas Constable: In summary, in order to convict any self-righteous person of his guilt before God, Paul reminded his readers of three principles by which God will evaluate all people.

- He will judge **righteously**, in terms of reality, not just appearance (**v. 2**).
- He will judge people because of **their deeds**, what they actually do, both covertly and overtly (**v. 6**).
- Moreover, He will judge **impartially**, not because of how much or how little privilege they have enjoyed but how they responded to the truth that they had (**v. 11**).

Everett Harrison: The implication in the opening verse is that a Jew is auditor, heartily endorsing the verdict rendered concerning the Gentiles, fails to realize his own plight. True judgment rests on the ability to discern the facts in a given case. If one is able to see the sin and hopelessness of the Gentile, he should logically be able to see himself as being in the same predicament. But he is so taken up with the faults of others that he does not consider his own failures (cf. **Matt 7:2, 3**). . . As he moves to state the first of the principles of divine judgment, he carries the observer with him. Surely this man will agree (“*we know*”) that when God pronounced judgment on those who make a practice of indulging in sin, his judgment is **based on truth**. . .

Paul carries the probing deeper still (**v. 4**), suggesting that in addition to self-righteousness with its accompanying false security there is an ignoring and despising of the fact that God, to be true to himself, must bring sin into judgment. . .

The apostle speaks plainly (**vs. 5-11**) in order to startle the Jew out of his lethargy of self-deception. What the nation is doing by its stubbornness and impenitence is to invite retribution, which is slowly but surely building up a reservoir of divine wrath that will be crushing when it breaks over the guilty in the day of reckoning. Then the judgment will be revealed, patent to all, on contrast to the indirect working of God’s wrath in the present scene, as depicted in **chapter 1**. At that time a second principle of divine judgment will become apparent, emphasizing **performance**: “*to each person according to what he has done*” . . .

Mention of the two divisions of mankind [those who persist in doing good and those who follow an evil course] leads naturally to the pronouncement of the third principle: God’s judgment is **impartial**.

R. Kent Hughes: Inherent in the common thinking that because everyone is doing it, it is not so bad—as long as we do not commit the “biggies” we will be okay—is the assumption that God does not mean what he says or say what he means.

This problem is twofold: first, man does not understand God’s holiness, and, second, he does not understand his own sinfulness. As to God’s holiness, sinful man’s idolatrous mind fails to see God as the transcendent, wholly other, perfect God who is infinitely above him, but rather imagines that he is like himself. As to sin, man forgets that he is made in the image of God and that every sin communicates a distortion of the image of God to the rest of creation. It is through such ignorance that the world suggests that if God does judge as he says, he insults his own integrity, holiness, and justice.

The eternal fact is, God means what he says and says what he means. Moreover, his judgment, despite moralisms to the contrary, is perfect. That is what **2:1–16** is all about. As we come to understand (or reaffirm our understanding of) the perfection of God’s judgment, we will bring health to our souls. For those of us who are believers, this will drive us toward a greater authenticity in life—and thus spiritual power. For the non-Christian, there will be strong encouragement to face fundamental issues about oneself and God.

James Boice: The Principle of God’s Judgment

- a. It is according to truth (**2:2**).
- b. It is proportionate to the number of sins (**2:5**).
- c. It is according to the standard of perfect righteousness (**2:5**).
- d. It is impartial (**2:11**)
- e. It is according to one’s deeds (**2:6-10, 12-15**).

Alva McClain. We are going to find some “*things hard to be understood*” (**2 Pe 3:16**). Some say, for instance, that Paul teaches salvation by works, and at first glance it looks that way too. But remember that Paul is not trying to show men how to be saved; he is trying to show men why they are lost. So you will find not gospel in this section. He is dealing with a crowd of men who stand off and say, “We are righteous in ourselves.” He is trying to sweep away their refuge, to cut the foundation from beneath them. God is talking about judgment!

Leon Morris: It is the invariable teaching of the Bible and not the peculiar viewpoint of any one writer or group of writers that judgment will be on the basis of works, though salvation is all of grace. Works are important. They are the outward expression of what the person is deep down. In the believer they are the expression of faith, in the unbeliever the expression of unbelief and that whether by way of legalism or antinomianism.

Leedy Greek NT Diagrams:

Rom 2:1

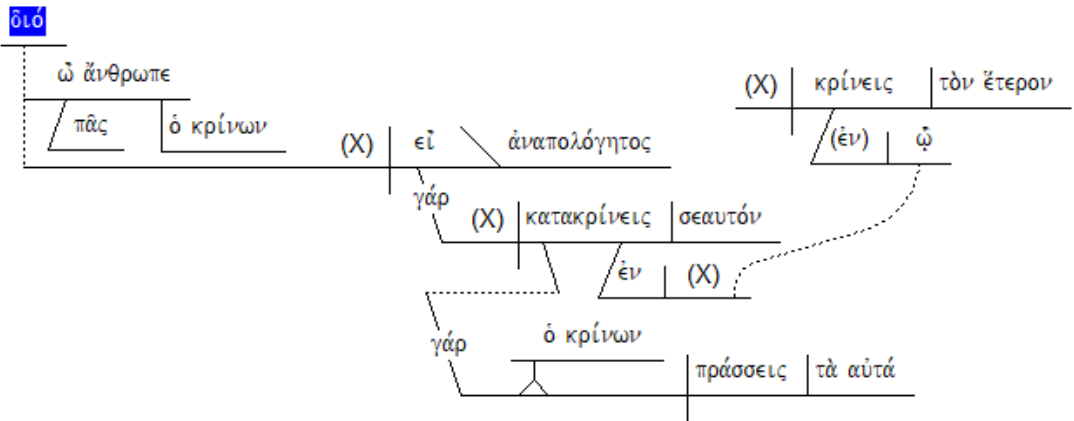

Rom 2:2

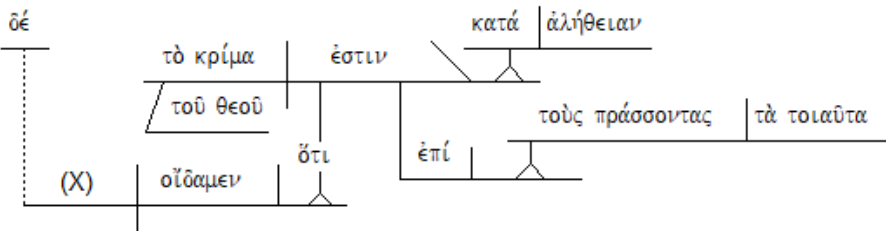

Rom 2:3

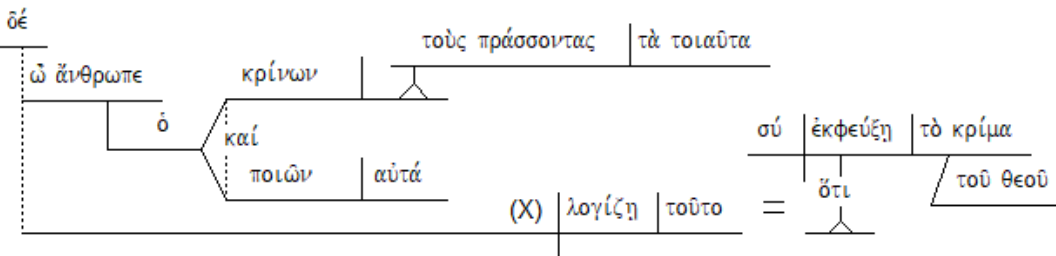

Rom 2:4

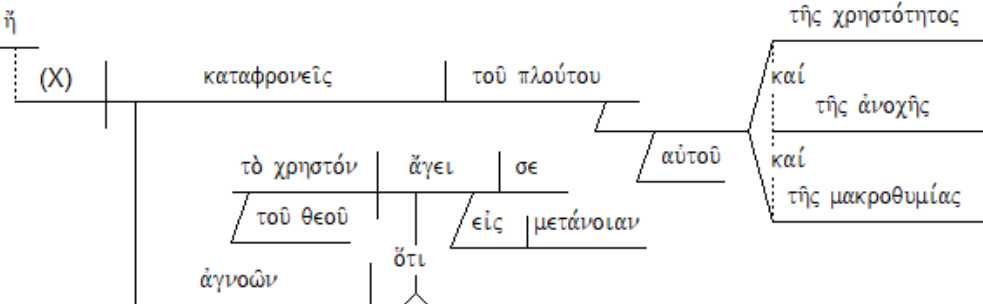

Rom 2:5-8

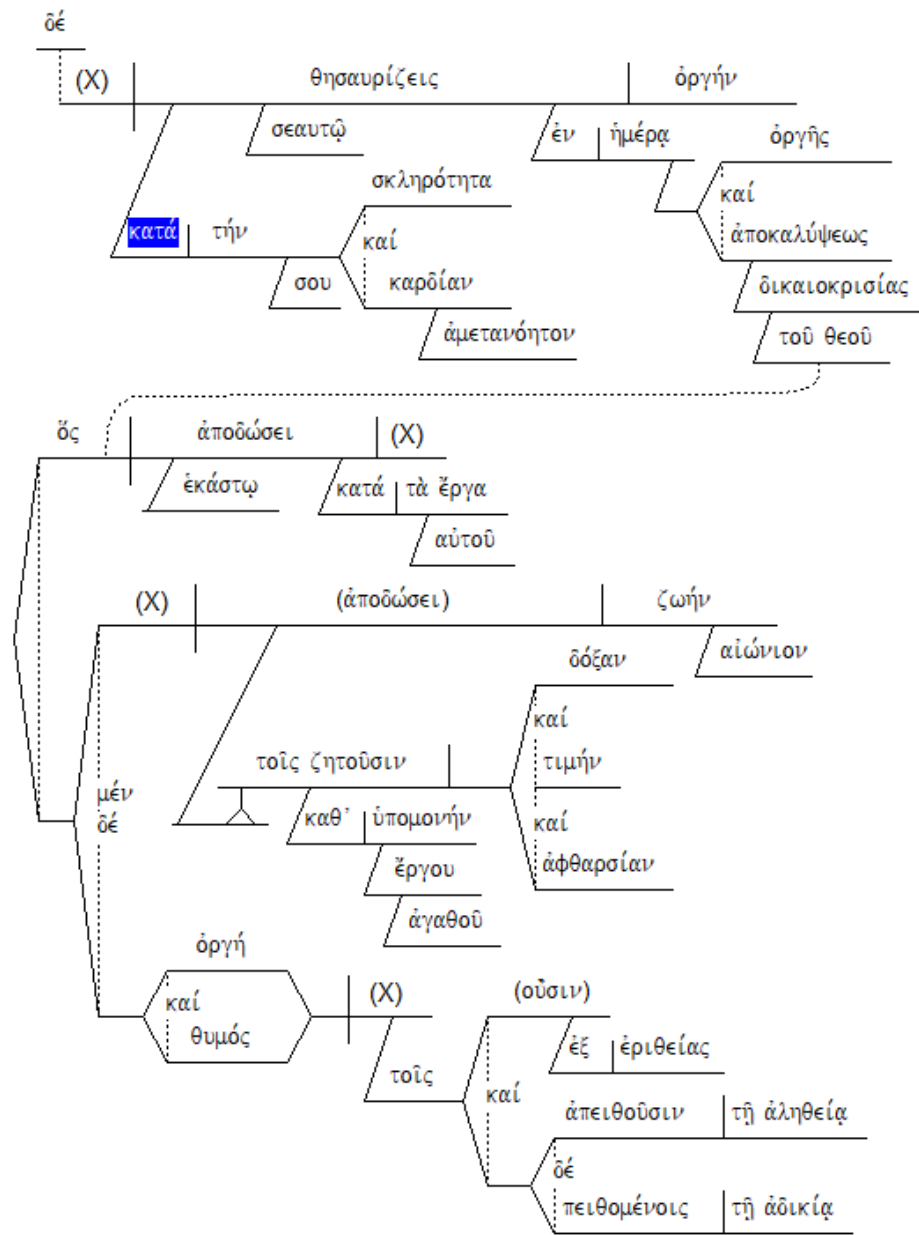

Rom 2:9-11

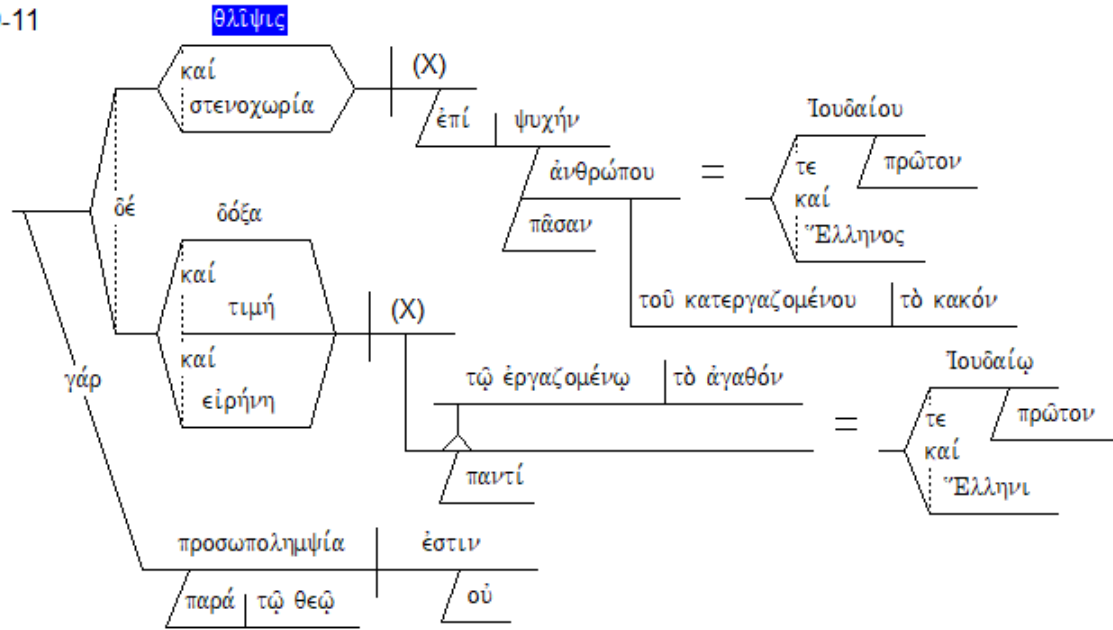

Rom 2:12-13

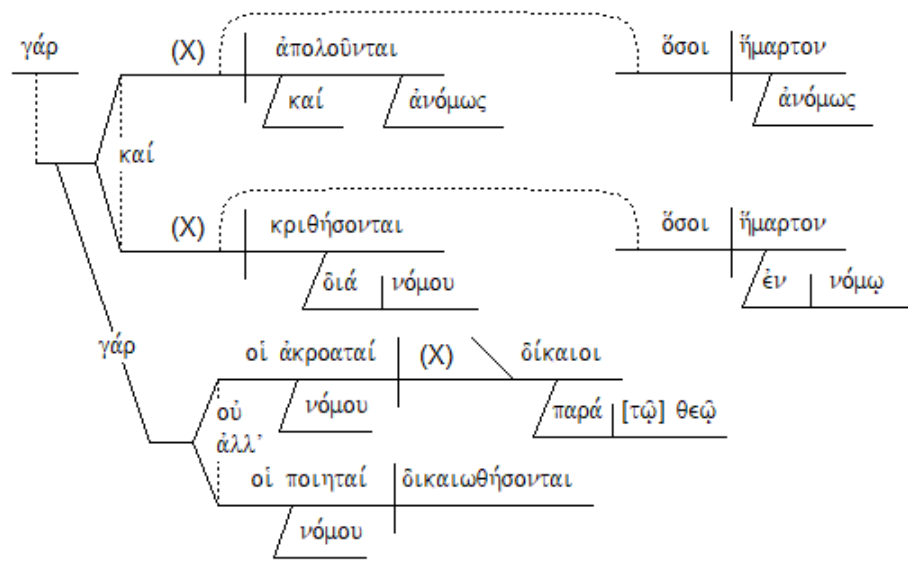

Rom 2:14-16

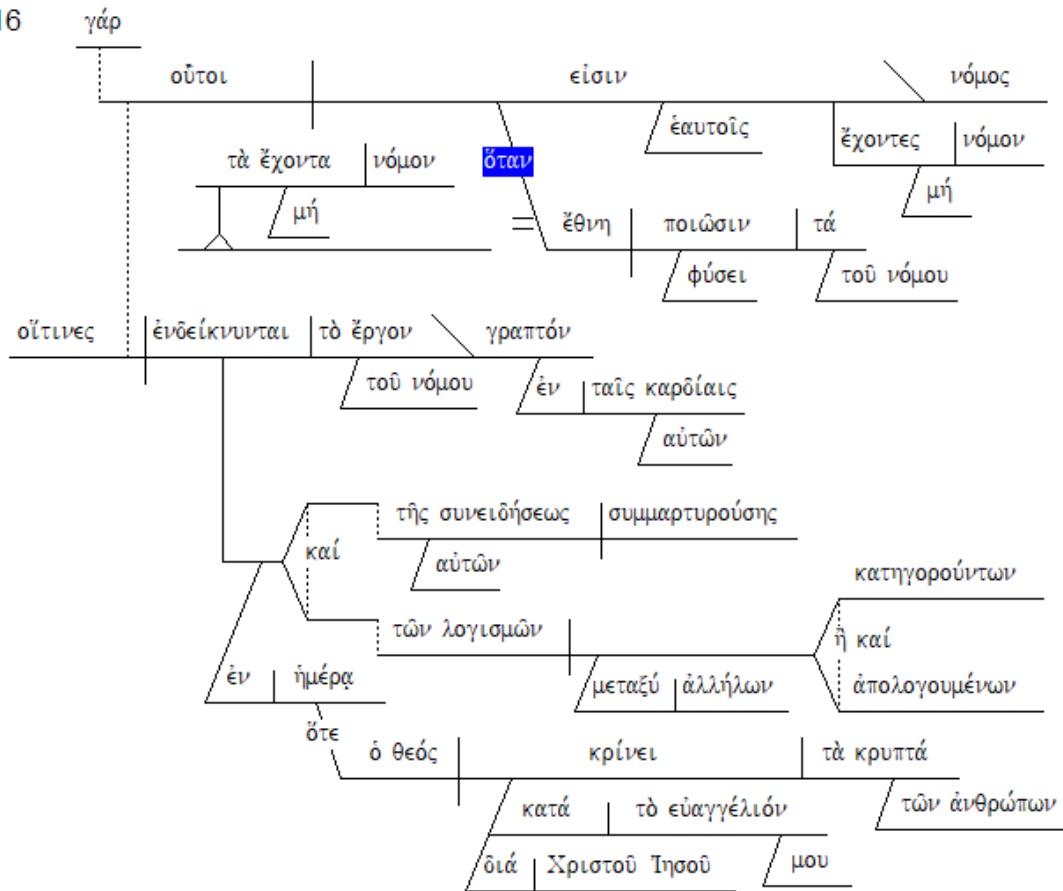

Frank Thielman:

1a Inference	Therefore, you are without excuse, O man
b Description	everyone who judges.
c Sphere	For in that which you judge the other,
d Explanation of 1a	you condemn yourself,
e Explanation of 1c-d	for you—the one who judges—practice the same things.
2a Assertion	Now we know that the judgment ...
b Agency	pronounced by God
	on those who practice such things
c Object	... is according to truth.
3a Rhetorical Question	And do you, O man think this:
b Description	who judges those who practice such things and does them yourself
	that you will escape the judgment pronounced by God?
c Content	
4a Rhetorical Question	Or do you despise the abundance
b List	of his [1] kindness and
c	[2] forbearance and
	[3] patience.
d	not knowing that the kindness of God is trying to lead you to a complete change of mind?
5a	But in accord with your hardness and unchanging heart
b Assertion	you are treasuring up wrath for yourself in the day of
c Expansion	the wrath and
d	the revelation
e Agency	of the righteous judgment of God
6a Description	who will render
b Manner	in accord with his or her works: (Prov 24:12; Ps 62:12)
	to each person
7a Explanation	on one hand
	eternal life
	to those who seek glory and

b List			honor and
c			immortality
d Means			by endurance in good work; but,
8a Alternative	on the other hand, there will be	wrath and anger	for those characterized by selfish ambition and
b Description			who are disobedient to the truth but obedient to unrighteousness
9a Restatement (of 8a)		affliction and distress	on every human life who works at what is bad, the Jew first and also the Greek; but
b Expansion			
c			
d Alternative		glory and honor and peace	
10a Object			to everyone who works what is good, the Jew first and also the Greek.
b Expansion			
c			
11a Explanation of 2:6-10	For there is no partiality with God.		
12a Explanation cont.	For as many as have sinned ...		
b Sphere	apart from the law		
c Result	... will also be destroyed		
d Sphere	apart from the law,		
e Restatement/Contrast	and as many as have sinned ...		
f Sphere	in the law		
g Result	... will be judged		
h Sphere	through the law.		
13 Explanation of 2:11-12	For it is not the hearers of the law who are righteous before God, but the doers of the law will be justified		
14a Explanation of 2:13	For	whenever gentiles	do the things of the law, who do not have the law by nature,
b Description			
c Assertion	they are a law to themselves		
15a Explanation	in that (1) they show the work of the law written in their hearts, (2) their conscience bearing witness with them and (3) their thoughts among one another		
b List			accusing or even defending
c			
16a Time			on the day when God judges the hidden things of human beings
Standard			according to my gospel, through Christ Jesus.
b Agency			

TEXT: ROMANS 2:17-29

TITLE: RELIGION NEVER SAVED A SOUL – JEWS NOT EXEMPT FROM CONDEMNATION – EXPOSING FALSE RELIGIOUS SECURITY

BIG IDEA:

EVEN THE MOST RELIGIOUS PERSON (DEVOUT JEW) CANNOT ESCAPE GOD'S RIGHTEOUS JUDGMENT--TRUE SPIRITUALITY IS MUCH MORE THAN POSSESSING RELIGIOUS PRIVILEGES AND PRACTICING RELIGIOUS RITUALS

INTRODUCTION:

Frank Thielman: Paul wants to demonstrate to his Roman readers, by means of this fictional dialogue with a Jew, that Jews as well as gentiles are transgressors and that their Jewishness gives them no privileges over gentiles on the day of judgment. Just as condemning the unrighteous person and possessing the Mosaic law will not permit Jews to escape God's judgment (2:1–16), so teaching the Mosaic law and possessing physical circumcision will count for nothing on that day (2:17–29). **Keeping the law from the heart**, not making judgments based on it, possessing it, or teaching it to others, will bring praise from God. The difference in the two sections lies in the way Paul makes his point: now he focuses on the failure of Jews to fulfill their vocation of being a light to the gentiles (2:17–24) and shows that physical circumcision is not the defining boundary of the people of God (2:25–29).

Main Idea: Neither knowing the law so well that one can teach it to others nor possessing physical circumcision will exempt the Jew from God's judgment of the sinner. Only doing what God requires, from the heart, will bring praise from God on the final day. . . This section is devoted to the question of Jewish identity: What makes a Jew a Jew and therefore part of the people who will survive the final day of judgment?

The paragraph consists of fifteen elements (2:17–23) and a closing quotation from Scripture (2:24). The fifteen elements describe Paul's interlocutor with three lists of five characteristics each, and the whole list of fifteen exerts a powerful rhetorical force, using anacoluthon, polysyndeton, and asyndeton.

Douglas Moo: Possession of the law and the covenant sign of circumcision were perhaps the two most distinguishing marks of being Jewish. Given to Israel by God himself, they signaled the fact that the Jews were a special people, elevated above all other peoples. In discussing their value in these verses, then, Paul is discussing the ultimate value of being Jewish.

Let us recall the key point the apostle has made thus far: The Jews, because they do "*the same things*" as the Gentiles, are, like the Gentiles, subject to God's wrath (vv. 1–5). But in putting the Gentiles and the Jews on equal footing, Paul could be accused of ignoring the special place that Jews have before God. Thus, without dismissing the Jews' privileges entirely (see 3:1), he insists that the blessings God gave his people Israel did not, in themselves, bring rescue from divine judgment. Those blessings must be responded to in **obedience**. As Paul has made clear already

(vv. 6, 13), it is doing God's will, not knowing it or teaching it, that matters in the judgment. At precisely this point the Jews have fallen short.

Timothy Keller: **Moralism** is extremely common, and always has been. It is the biggest religion in the world today. It is the religion of people who compare themselves with others, who notice that they are "a lot more decent than other people," and conclude: If there is a God, he'll certainly accept me. I'm a good person.

How do we know if we have lapsed into "Christian" moralism as the source of our righteousness? Whenever we brag about something we have done—when we rely on our own action, profession or identity—we are living as functional moralists. . .

The crushing result of Christian moralism is that it dishonors God (v 23). When religious people boast about their law-keeping while breaking the law, usually the only person who cannot see what they are doing is them. "*God's name is blasphemed among the Gentiles because of you*" (v 24). This is a convicting principle. A life of religious legalism is always distasteful to those outside the faith. A moralist will be **smug** (they are good people); **over-sensitive** (their goodness is their righteousness, so must not be undermined); **judgmental** (they need to find others worse than them in order to be good); and **anxious** (have they done enough?).

John Murray: The thrust of the passage flows out of the principle enunciated in **verse 13** that "*not the hearers of the law are just before God but the doers of the law shall be justified*". The apostle now addresses the Jew directly and pointedly and shows him that all the privileges and prerogatives he enjoyed only **aggravated his condemnation** if he failed to carry into effect the teaching which he inculcated.

John MacArthur: He is exploding the myth of **Jewish false security** in order that they might be brought to the point of true and genuine security. Now they felt themselves secure before God and they felt that some day they would go to heaven and enter the kingdom. They felt that they would never be judged or punished or condemned for three basic reasons. And these were the basic elements of their security.

- Number one was their **nation**.
- Number two was their **law**.
- And number three was their **sign**.

Based on the nation, the part of the law they had been given, and the sign of circumcision, they felt themselves to be secure. Paul then attacks those securities and shows that they are no security at all; in fact they only serve to **aggravate the condemnation** that is inevitable. It is necessary to tear down people's false security in order to reveal their danger and then to offer to them the true security, faith in Christ.

I. (:17-24) TRUE SPIRITUALITY IS MUCH MORE THAN POSSESSING RELIGIOUS PRIVILEGES

A. (:17-20) Religious Privileges Can Produce False Security

1. (:17a) Privilege of Special Identity

“But if you bear the name ‘Jew,’”

Barclay: The Jew believed that everyone was destined for judgment except himself. It would not be any special goodness which kept him immune from the wrath of God, but simply the fact that he was a Jew.

2. (:17b-18) Privilege of Special Revelation and Discernment

*“and rely upon the Law, and boast in God, 18 and know His will,
and approve the things that are essential, being instructed out of the Law,”*

Lenski: To glory in God means to find one's highest treasure in God and to manifest this.

3. (:19-20) Privilege of Special Ministry to the Gentiles

*“and are confident that you yourself are a guide to the blind,
a light to those who are in darkness,
20 a corrector of the foolish,
a teacher of the immature,
having in the Law the embodiment of knowledge and of the truth,”*

Timothy Keller: First, Paul lists six things the Jews were proud of when it came to how they lived—their **moral goodness**:

- *“You call yourself a Jew”* (v 17)—they were proud of their nationality, pleased to be Jews.
- *“You rely on the law”* (v 17)—a pride in having and knowing the law God had revealed to their ancestor, Moses, at Mount Sinai (see **Exodus 19 – 31**).
- You *“brag about your relationship to God”* (**Romans 2:17**)—God had chosen Israel to be his people (**Exodus 19:4-6**).
- *“You know his will and approve of what is superior”* (**Romans 2:18**)—they were able to make correct ethical decisions, and they were able to see the wrong choices others were making. Following the detailed rules and regulations in the law of God gave them a sense of being pleasing to God, particularly as they compared themselves to others.
- *“You are instructed by the law”* (v 18)—they did not only *“have”* the law, they had mastered it. They could quote it; cross-reference it; go deep into the details of it.
- *“You are convinced that you are a guide for the blind”* (v 19)—they know that they can see, and that others cannot because they are lost in idolatry, and so they spread the knowledge of the law.

B. (:21-24) Religious Privileges Mean Nothing If Your Life Doesn't Measure Up

Your life will show whether or not you truly belong to God or whether you are a hypocrite.

1. (:21a) General Test of Authenticity vs. Hypocrisy =

You Must Practice What You Preach

*“you, therefore, who teach another,
do you not teach yourself?”*

Assumption = what you teach is God's truth and His standard of righteousness

2. (:21b-22) Three Specific Examples of Hypocritical Law Breaking

- a. (:21b) Stealing
“*You who preach that one should not steal, do you steal?*”
- b. (:22a) Adultery
“*You who say that one should not commit adultery, do you commit adultery?*”
- c. (:22b) Idolatry
“*You who abhor idols, do you rob temples?*”

Frank Thielman: As the frequent occurrence of “temple robbery” in vice lists from antiquity shows, profiting from goods stolen from temples was common. Paul is probably pointing out here that the Mosaic law prohibited temple robbery because of the danger that it might lead those who possess such materials into idolatry (cf. **1 Cor 10:14, 20**). His point, then, is that his interlocutor detests idolatry but opens the door to this very vice by profiting from the sale of items taken from gentile temples.

3. (:23-24) Spiritual Hypocrisy Dishonors God and Destroys Your Testimony

“*You who boast in the Law, through your breaking the Law, do you dishonor God? 24 For ‘the name of God is blasphemed among the Gentiles because of you,’ just as it is written.*”

John Murray: The tragic irony is apparent. The Jews who claimed to be the leaders of the nations for the worship of the true God had become the instruments of provoking the nations to blasphemy. With this the indictment has reached its climax.

II. (:25-27) TRUE SPIRITUALITY IS MUCH MORE THAN PRACTICING RELIGIOUS RITUALS

A. (:25) Religious Rituals Have No Value Apart from Obedience

1. Circumcision Has Value If You Obey the Law

“*For indeed circumcision is of value, if you practice the Law;*”

Frank Thielman: What is this **benefit**? Since Paul says that transgression of the law metaphorically turns the circumcised Jew into someone who is uncircumcised, the benefit of circumcision must be **membership among the Jewish people**. Their advantage is access to God’s word in the Mosaic law, with its promises that God would be faithful to his people (**3:1–4**; cf., e.g., **Deut 4:31**).

2. Circumcision Has No Value If You Transgress the Law

“*but if you are a transgressor of the Law, your circumcision has become uncircumcision.*”

B. (:26-27) Obedience Transcends Religious Rituals

1. (:26) Obedience Qualifies for Covenant Status

“If therefore the uncircumcised man keeps the requirements of the Law, will not his uncircumcision be regarded as circumcision?”

2. (:27) Obedience Qualifies for Moral Superiority over Transgressors

“And will not he who is physically uncircumcised, if he keeps the Law, will he not judge you who though having the letter of the Law and circumcision are a transgressor of the Law?”

III. (:28-29) TRUE SPIRITUALITY THAT PLEASURES GOD IS AN INWARD REALITY ACCOMPLISHED BY THE HOLY SPIRIT

A. (:28) Outward Appearances Can Be Deceiving

1. Outward Appearance Cannot Validate Our Spiritual Identity

“For he is not a Jew who is one outwardly;”

2. Outward Appearance Cannot Give Significance to Religious Rites

“neither is circumcision that which is outward in the flesh.”

B. (:29) Inward Reality Constitutes True Spirituality

1. Inward Reality Validates Our Spiritual Identity

“But he is a Jew who is one inwardly;”

Arnold G. Fruchtenbaum: These verses [vv. 25-29] must be kept in their context, which is that Paul is dealing with Jews and making a distinction between Jews who believe and Jews who do not believe. He is not teaching that every Gentile Christian is a spiritual Jew. Rather, he is teaching that **every Jew is not a full Jew**. A completed Jew is one who has had both circumcisions, the circumcision of the flesh, which is outward in obedience to the Abrahamic covenant, and an inward circumcision of the heart as an act of obedience to the new covenant.

2. Inward Reality Accomplished by the Spirit Gives Significance to Religious Rites

“and circumcision is that which is of the heart, by the Spirit, not by the letter;”

Robert Gundry: The contrast lies between God’s Spirit as the enabler of Law-keeping and the Law as a dead letter on scrolls that can’t enable obedience to it (compare **7:6; 2 Corinthians 3:1–11**). Though human beings—in particular, non-Christian Jews— withhold praise from such a Gentile because he hasn’t gotten physically circumcised, God will praise him at the Last Judgment. It helps Paul’s line of reasoning that the Hebrew word for “*Jew*” plays on the Hebrew word for “*praise*,” as in **Genesis 49:8** according to the original Hebrew text. The Mosaic law required circumcision for membership in God’s people, Israel; but Paul declares circumcision unnecessary for membership in God’s people, the church. For Christians, then, the Law that’s necessary to be kept and is evidentially kept consists in the moral law exclusive of ritual law.

3. Only Inward Reality Pleases God

“and his praise is not from men, but from God.”

Douglas Moo: Verses 28–29 are a kind of appendix to this argument. Paul has made clear that being circumcised and possessing the law (v. 27b) do not, by themselves, qualify a person to be part of God’s true, spiritual people. Such outward marks, to be sure, can show that a person belongs to the “physical” Israel. But real Jewishness can never be determined by physical birth, by cuts on our skin, or by devotion to a particular book. To be a “real Jew” is an inward matter. It is marked by the “circumcision of the heart,” a circumcision that comes in the context of the Spirit, not the “written code.”

* * * * *

DEVOTIONAL QUESTIONS:

- 1) Does the Word of God convict you in your heart and do you modify your behavior to practice what you learn from the Word and what you preach to others?
- 2) Are there ways in which you see Christian churches promoting a dead orthodoxy or fostering false security?
- 3) Are you able to value your spiritual privileges without exempting yourself from your own accountability before God?
- 4) Where do you make your boast when it comes to the basis of your salvation?

* * * * *

QUOTES FOR REFLECTION:

Frank Thielman: The Scriptures frequently assert that God is far more concerned that his people practice justice and mercy than that they observe various sacrificial rituals. **Psalm 50** is an especially clear statement of this concern. It pictures the just Creator of all the earth calling his people together in the presence of all he has created and testifying against them (**Ps 50:1–7**). “*Not for your sacrifices do I rebuke you,*” God begins; “*your burnt offerings are continually before me*” (**50:8**). God is not that interested in these things. It is not as if he is hungry and needs “*to eat the flesh of bulls*” and “*drink the blood of goats*” (**50:13**). Rather, God wants his people to be thankful and faithful to him and to trust him to deliver them in the day of trouble (**50:14–15**). In other words, he is not a petty deity that human beings can bribe with sacrifices but the one God who wants to be in a personal, heartfelt relationship with those whom he has created. Similarly, God is not impressed with people who recite his statutes and take his covenant on their lips but are pleased with thievery, keep the company of adulterers, and slander others behind their backs (**50:16–20**). God wants his people to be thankful to him for all he has done for them and, out of these thankful hearts, to live in the way God has charted for them (**50:23**).

God complains in this Psalm that his people know sacrificial procedure well and enjoy discussing and practicing it, but, in the process, their gratitude to him has grown dim and they have forgotten his commitment to justice.

At the beginning of Isaiah, God indicts Israel in the same way. They have paid inordinate attention to sacrificial ritual and the religious calendar at the same time that they are practicing “*iniquity*” and their “*hands are full of blood*” (**Isa 1:10–15**). God has had enough of their sacrifices (**1:11**) and their mixture of solemn assembly with iniquity (**1:13**). His people need to “*learn to do good; seek justice, correct oppression; bring justice to the fatherless,*” and “*plead the widow’s cause*” (**1:17**; cf. **Hos 6:4–6; Amos 4:4–5; 5:21–25; Mic 6:6–8**).

R. Kent Hughes: The Heart of the Matter

We have the antidote to such **self-deception** in **2:17–29**, where Paul warns religious people like us to guard ourselves from the dangers of a false religious confidence. Paul underlines two principal dangers here.

- The first is the danger of thinking we are okay because we possess the truth. **Paul’s Warning About Overconfidence (vv. 17–24)** This, of course, was the great danger for the religious-minded Jew of Bible times. Every Jew realized that in respect to the truth he was privileged far above the rest of the people on the earth. Paul insightfully describes this sense of privilege in **verses 17, 18**. . . These six things were wonderful privileges. But as wonderful as they were, they had a deluding effect on the Jews. When they compared their enlightenment with the abysmal theological ignorance of the Gentiles they looked very good. Of course they were acceptable to God!
- **Paul’s Warning about False Security in Association (vv. 25–27)** There is another danger, a natural twin to the danger of thinking we are acceptable to God because we have the truth: namely, thinking we are right before the Lord because we are affiliated with his people. The Jews supposed they were secure because they were part of God’s chosen people through circumcision. They believed circumcision somehow secured salvation.

In applying this to ourselves, all we have to do is substitute for the word “*circumcision*” any of the following: church membership — baptism — confirmation — Methodist — Baptist — Presbyterian — and so on. The great mistake of Catholics, Protestants, and Jews when asked about their relationship to God is to cite their religious affiliation as evidence of their relationship.

- “Are you a believer?” “Of course. I’ve been a member of First Church for twenty-five years.”
- “Are you a believer?” “I’m a Catholic! Does that answer your question?”
- “Are you a believer?” “Why yes, I was baptized right here in Christian Church.”

There are as many answers as there are affiliations and rites, but none will convince God—they are all **outward circumcisions**.

David Thompson: IN MAKES NO DIFFERENCE HOW RELIGIOUS A PERSON IS, WITHOUT A PERSONAL RELATIONSHIP WITH JESUS CHRIST THAT PERSON IS GUILTY AND CONDEMNED IN THE SIGHT OF GOD.

- A person's guilt is not eliminated by a person's religious heritage. **2:17-20**
- A person's guilt is established by a person's own religious teaching. **2:21-24**
- A person's guilt is not eliminated by external religious rites, but by an internal righteous heart. **2:25-29**

<https://media-cloud.sermonaudio.com/text/10722192784163.pdf>

Mounce: In the previous section Paul addressed his Jewish readers in a relatively restrained manner. But here the mood changed. Once again he employed the **diatribe style** that he used in the opening verses of **chap. 2**. His tone became quite severe as he laid out before them the absolute necessity of bringing their conduct into line with their profession. From this point on to the end of the second major division (**Rom 3:20**), we hear Paul the preacher convincing his listeners of their need for a different kind of righteousness. Although in another letter he claimed that his preaching was not eloquent (**1 Cor 2:1-5**), it is hard to deny that here in Romans we are dealing with the dynamic rhetoric of an evangelist bent on persuasion.

Timothy Keller: How can we tell if our "faith" is empty, dead, and under God's judgment? These verses push us to some potentially uncomfortable self-diagnosis. There are two signs Paul gives us here:

- There is a **theoretical-only stance toward the word of God (Romans 2:21)**. The moralist or dead orthodox Christian loves the concepts of truth, but is never changed by them. They often see how a sermon or Bible text ought to convict others, but they seldom (if ever) let it convict them. A real Christian finds the Bible "*living and active*" (**Hebrews 4:12**); when they hear it or read it, they are convicted, comforted, thrilled, disturbed, melted, slammed down, lifted up. Paul prompts us to ask: Which am I? Do I teach myself?
- There is a **moral superiority**, an in-built bragging. If you are relying on your spiritual achievements, you will have to "look down" on those who have failed in the same areas. You will be at best cold, and at worst condemning, toward those who are struggling. Rather than speaking words of encouragement to the struggler, helping to lift them up, you speak words of gossip about them to others, to show yourself in a comparatively good light. A sign of this condition is that people don't want to share their problems with you, and you are very defensive if others point out your problems to you. . .

Dead orthodoxy makes the church into a religious cushion for people who think they are Christians, but in fact are radically and subconsciously insecure about their acceptance before God. So every Sunday, people gather to be reassured that they are all right. Various churches offer this reassurance in different ways:

- Legalistic churches produce detailed codes of conduct and details of doctrine. Members need continually to hear that they are more holy and accurate, and that the "liberals" are

wrong. They functionally rely on their theological correctness. Sound doctrine equals righteousness.

- Power churches put great emphasis on miracles and spectacular works of God. Members need continually to have powerful or emotional experiences and see dramatic occurrences. They rely on their feelings, and on dramatic answers to prayer. Great emotion equals righteousness.
- Sacerdotal churches put great emphasis on rituals and tradition. Guilt-ridden people are anaesthetized by the beauty of the music and architecture, and the grandeur and mystery of the ceremony. Following liturgy equals righteousness.

Of course theological accuracy, moral conscientiousness, praying in faith, being powerfully affected by gospel truths and beautiful worship are all good things! But these elements are so easily, and so regularly, used as a form of “dead works”—replacements for reliance on the righteousness revealed by God in Christ, and received by us in Christ.

Steven Cole: (:17-24) Big Idea: Hypocrisy deceives the hypocrite, damages unbelievers, and dishonors God. . .

Since deception is always a tricky thing to overcome, **how can we overcome the deception of hypocrisy?** There are no slick formulas, but let me offer a few action points:

First, fight daily to maintain reality with God on the heart level. Meet with Him in the Word and in prayer, not to check off that you did your “quiet time,” but to come before Him and expose everything in your heart to Him. Confess your sins and your struggles. Seek His strength. Be aware that He examines your heart (**1 Thess. 2:4**).

Second, cultivate honesty and humility towards others. Don’t try to impress others with your godliness. Let them know that you are weak, but the Lord is strong.

Finally, when you read and meditate on the Bible, aim at applying it personally. Ask, “So what? How am I supposed to live in light of this text?” And, if you struggle with a particular sin (anger, lust, greed, etc.), memorize relevant verses to help you apply it. Don’t let the sin of hypocrisy deceive you, damage unbelievers, or dishonor our glorious God!

<https://bible.org/seriespage/lesson-12-what-hypocrisy-does-romans-217-24>

(:25-29) Big Idea: Reality with God is not a matter of outward conformity to religious rituals, but rather of obedience that results from God changing your heart. . .

The New Testament is clear that being baptized or partaking of communion are of no spiritual value, unless you do them out of faith in Christ. Baptism, whether performed on infants (which I believe is wrong) or on those old enough to understand what it means, does not convey salvation or forgiveness of sins. Neither does partaking of the Lord’s Supper. If the baptized person acts in obedience to Christ as a confession of saving faith in Christ, then baptism is of great value. If we partake of the Lord’s Supper as a reminder of His death on our behalf and of all that that means to us, it, too, is of great value. We should not minimize or abandon these rituals. But there is no spiritual benefit conveyed just by going through these religious rituals, apart from reality with God through faith in Christ. So Paul’s first point is that reality with God is not a matter of outward conformity to religious rituals.

<https://bible.org/seriespage/lesson-13-ritual-versus-reality-romans-225-29>

Leedy Greek NT Diagrams:

Rom 2:17-21

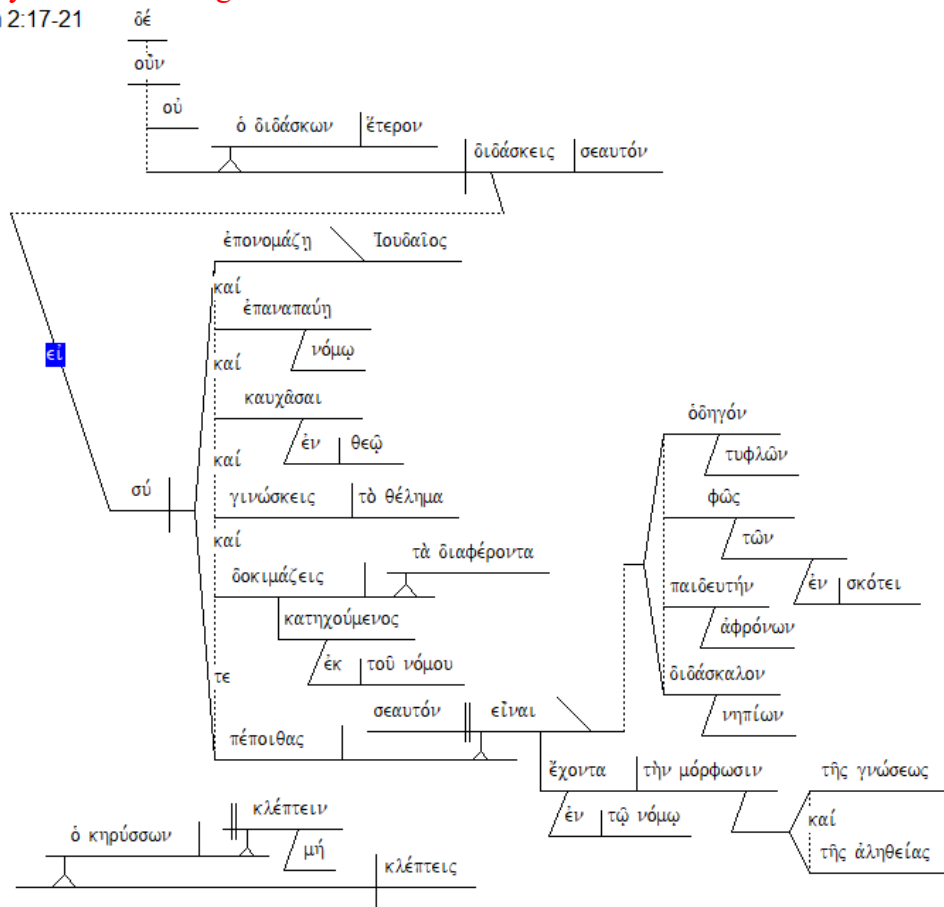

Rom 2:22

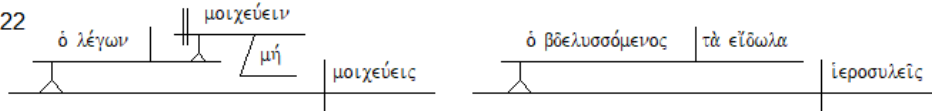

Rom 2:23-24

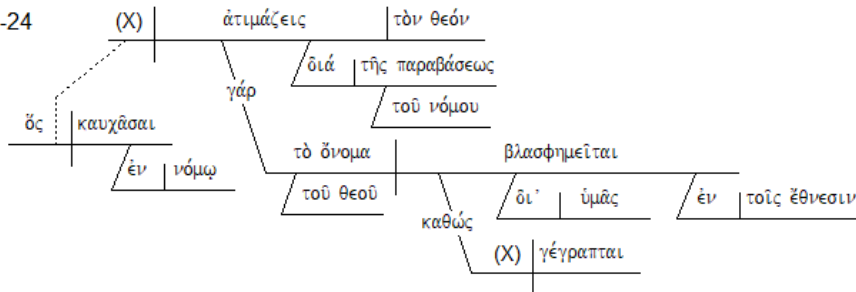

Rom 2:25

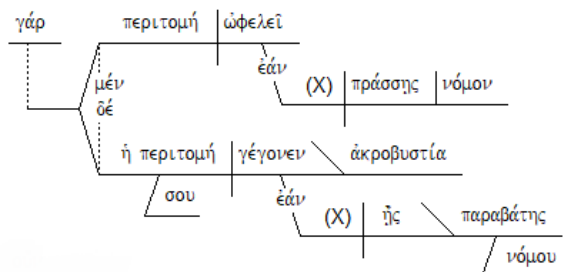

Rom 2:26

οὖν

οὐχ

ἡ ἀκροβυστία λογισθήσεται

αὐτοῦ

εἰς

περιτομὴν

ἡ ἀκροβυστία φυλάσσει τὰ δικαιώματα

τοῦ νόμου

Rom 2:27

καί

ἡ ἀκροβυστία

κρινεῖ

σέ

=

τὸν παραβάτην

γράμματος

ἐκ φύσεως

τελοῦσα τὸν νόμον

νόμου

διὰ

καί

περιτομῆς

Rom 2:28-29

γάρ

ἐν τῷ φανερῷ

ὁ

ἐστίν

Τουδαῖος

οὐδέ

ἐν τῷ φανερῷ

ἡ

ἐν σαρκί

(ἐστίν) περιτομή

οὐ

ἀλλ'

ἐν τῷ κρυπτῷ

ὁ

(ἐστίν) Τουδαῖος

καί

περιτομή

(ἐστίν) καρδίας

πνεύματι

ἐν

οὐ

γράμματι

ὁ ἔπαινος

(ἐστίν)

ἐξ ἀνθρώπων

οὐ

οὐκ

ἀλλ'

ἐκ τοῦ θεοῦ

Frank Thielman:

- | | | | | | |
|-----|---------------------|------|--|--|-----------------------------------|
| 17a | Condition/List | But | if you | [1] call yourself a Jew and | |
| b | | | | [2] rely on the law and | |
| c | | | | [3] boast in God and | |
| 18a | | | | [4] know his will and | |
| b | | | | [5] discern what is important, | |
| c | Cause | | | because you are instructed from the law. | |
| 19a | Condition/List | And, | | likewise, | |
| b | | | [if] you are persuaded that you are yourself | [1] a leader of the blind, | |
| c | | | | [2] a light to those in darkness, | |
| 20a | | | | [3] an instructor of the foolish, | |
| b | | | | [4] a teacher of infants, | |
| c | | | | [5] having the embodiment of knowledge ↵ | |
| | | | | and truth in the law. | |
| 21a | Rhetorical Question | [1] | You who | teach the other person— | do you not teach yourself? |
| b | Rhetorical Question | [2] | You who | preach not to steal— | do you steal? |
| 22a | Rhetorical Question | [3] | You who | say not to commit adultery— | do you commit adultery? |

- b Rhetorical Question [4] **You who detest idols— do you rob temples?**
 23 Rhetorical Question [5] **Do you who boast in the law dishonor God through ↯ ↯ transgression of the law?**
- 24a Result/OT Quotation For “the name of God is blasphemed
 b Sphere among the gentiles
 c Cause because of you” (Isa 52:5)
 d Comparison just as it is written.
- 25a Explanation For, on one hand,
 b Assertion **circumcision is beneficial**
 c Condition if you practice the law,
 d Contrast but, on the other hand,
 e Condition if you are a transgressor of the law,
 f Assertion **your circumcision becomes uncircumcision.**
- 26a Condition If, ...
 therefore, ... the uncircumcised person keeps the just ↯ ↯ requirements of the law,
- b Rhetorical Question **will not his uncircumcision be counted as circumcision?**
 27a Result **And the one who is by nature uncircumcised but**
 b Result/Concession **carries out the law will judge you**
 c Description who transgress the law
 d Contra-expectation despite the letter and circumcision.
- 28a Explanation For **the one who is a Jew in what is visible**
 b Restatement nor **is not a Jew, is circumcision in what is visible,**
 c Restatement **is circumcision in the flesh**
- 29a Contrast But **the Jew in secret is a Jew,**
 b Restatement **and circumcision of the heart is circumcision,**
 c Sphere in the Spirit and
 not the letter,
 d Assertion whose praise is not from human beings but from God.

TEXT: ROMANS 3:1-8

TITLE: *THE FAITHFUL RIGHTEOUS JUDGE*

BIG IDEA:

**GOD'S CONDEMNATION OF ALL MEN (EVEN THE MOST RELIGIOUS)
DOES NOT CONTRADICT:**

- THE VALUE OF SPIRITUAL PRIVILEGES OR
- THE CONSISTENCY OF GOD'S OWN CHARACTER
(HIS FAITHFULNESS AND JUSTICE)

INTRODUCTION:

Michael Bird: Paul now tries to anticipate the objections of his imaginary Jewish interlocutor. If it is true that the inherited privileges of the Jewish people (i.e., their monotheistic worship, divine election of the nation, and receiving the Torah) have had a null and void impact in making Israel any better than the pagan nations, then is the failure not really Israel's but actually God's failure? If Israel falters, has God failed to be faithful to his chosen people? If Paul is right, is not God's faithfulness put under a cloud of suspicion because God has reneged on his covenant promise to sustain and save Israel? Furthermore, if the logic holds that Gentiles and Jews alike are caught in evil and are justly condemned, then why bother following the Jewish way of life?

John Toews: The diatribe does not represent a digression in Romans, but a continuation of the discussion of **God's impartiality**. Paul correlates God's impartiality with God's faithfulness and righteousness in relationship to Israel even in **judgment**. The covenantal language affirms that God remains faithful to the promises to Israel despite her unfaithfulness and despite God's just judgment for this unfaithfulness.

Grant Osborne: Having firmly described the shared sinful condition of humankind, Paul turns to several thoughts about the unique benefits of being Jewish. He wants to remind his Jewish brothers that their lack of faith has not hindered God's plan. Paul does not want his people to miss the **significance of God's faithfulness**. In spite of their failures, God still allows them to be the people of the Messiah. In fact, the Jews' lack of faith is a clear witness to the absolute need for a Savior. Neither they nor we can save ourselves. God's faithfulness is our only hope.

Frank Thielman: Paul recognized that this second element of God's righteousness—that it means the impartial punishment of Jews alongside gentiles—was the most difficult part for biblically literate people to accept because the Scriptures single out the Jewish people as God's special possession and object of his love, mercy, and faithfulness (e.g., **Exod 19:5–6; Deut 4:32–39; 1 Kgs 8:52–53**). Paul therefore emphatically insists that God will punish Jews who disobey him no less than gentiles who disobey him. He makes his case so forcefully that he ends chapter two with the astonishing picture of an uncircumcised gentile keeping the law and receiving a more favorable judgment from God in the end than a circumcised Jew who breaks the law (**2:26–27**).

Paul knew that his explanation of God's righteousness along these lines generated an important set of questions. Has Paul left Jews with any advantage? Does his argument imply that the tables have turned and Jews are actually at a disadvantage when compared to gentiles? . . .

These questions come up again in **9:1 – 11:36**. There Paul will again address the question of whether his explanation of God's righteousness means that Israel has lost the advantage that, according to Scripture, God gave to it. In **9:1 – 11:36** Paul will be more concerned than he is here with exactly what the Scripture promised Israel and how these promises can be fulfilled in light of his gospel's explanation of salvation history. Here in **3:1–8** his concern is restricted to the issue of **whether God is fair** in punishing his people with his wrath since God promised to be faithful to them.

Timothy Keller: In the first eight verses of the chapter, Paul anticipates and answers some objections he knows **chapter 2** may have provoked among those in the Roman church who are from a Jewish background. These objections are not critical to Paul's argument, and they may not be objections we often hear raised today. But Paul was a great evangelist, and we see him here placing himself in his listeners' shoes, respecting them enough to think hard about how they would be responding to his teaching (he does something similar in **Acts 17:22-31** as he preaches in Athens).

These verses are thus best understood as a **Q+A session** between Paul and his imagined reader:
Q: Paul, are you saying there is no advantage to biblical religion (**v 1**)?

A: No, I'm not saying that. There is great value in having and knowing the words of God (**v 2**).

Q: Yes, but those words have failed, haven't they, because so many haven't believed the gospel of righteousness revealed in God's Son Jesus. What has happened to the promises (**v 3a**)?

A: Despite his people's failure to believe, God's promises to save are advancing. Our faithlessness only reveals how committed to his truth he is (think of what he's done in order to be faithful to his promises!) (**v 3b-4**).

Q: But if unrighteousness is necessary for God's righteousness to be seen, how is it fair for him to judge us (**v 5**)?

A: On that basis, God would not judge anyone in the world. And we (ie: Paul and religious Jews) all agree God should judge (**v 6**).

Q: Well then, if me sinning makes God look better, that means that I should sin more, shouldn't I, so that his glory is more clearly seen (**v 7-8**)?

A: I've been accused of thinking this, and I certainly don't. And saying you're sinning so that God will love you is an attitude that is absolutely worthy of judgment (**v 8**).

I. (:1-2) GOD'S CONDEMNATION OF ALL MEN DOES NOT CONTRADICT THE VALUE OF SPIRITUAL PRIVILEGES

A. (:1) Key Question – Any Value to Spiritual Privileges If They Can't Save?

1. Stated with Respect to Ethnic Identity

“Then what advantage has the Jew?”

2. Restated with Respect to Religious Rites

“Or what is the benefit of circumcision?”

Spiritual identity and religious heritage do not automatically gain God's favor – but that does not mean they are all a big waste.

B. (:2) Positive Answer --

1. Summary Answer

“Great in every respect.”

2. Primary Example

“First of all, that they were entrusted with the oracles of God.”

- a. There are many advantages and benefits--with the most important being possession and knowledge of the Word of God

"entrusted" implies a stewardship

Revelation (although it carries with it accountability) is a privilege and much preferred above the state of ignorance

- b. God has granted spiritual privileges not to promote complacency but to encourage application and outreach to others

Frank Thielman: Jews do retain important advantages over gentiles, despite their lack of any soteriological advantage over them. The gift of God's law, together with the responsibility of sharing that gift with the nations, is one of those advantages.

II. (:3-8) GOD'S CONDEMNATION OF ALL MEN DOES NOT CONTRADICT THE CONSISTENCY OF HIS OWN CHARACTER

A. (:3-4) He Remains Faithful to His Promises to the Jews

(reliable in performing His promises)

1. (:3) Is God's Faithfulness Nullified?

“What then? If some did not believe, their unbelief will not nullify the faithfulness of God, will it?”

Frank Thielman: Paul insists that the unfaithfulness of some Jews to their covenant responsibility to obey the law and be a light to the gentiles does not mean that God will be unfaithful to his word concerning them.

2. (:4) May It Never Be!

“May it never be! Rather, let God be found true, though every man be found a liar, as it is written, ‘That Thou mightest be justified in Thy words, And mightest prevail when Thou art judged.’”

Proof text from **Ps.51** where David reminds us that God will always be proved right (when all the facts are in) when He speaks--what He says will prove out to be true

Frank Thielman: Paul emphatically rejects the idea that the unfaithfulness of some Jews to their covenant with God could cancel God’s faithfulness to them. The expression “*certainly not!*” (μη γένοιτο) was an **interjection** used for putting a thought as far away from the discussion as possible. Depending on the context, it could mean, “Perish the thought!” (e.g., **Aeschylus**, Seven against Thebes 5; **Plutarch**, Lyc. 20.6; **Luke 20:16**), “Far be it from me!” (**Epictetus**, Diatr. 1.2.35; 1.5.10; 1.8.15), “Far from it!” (**Epictetus**, Diatr. 1.5.10), or, as here, “Certainly not!” Paul uses it in **1 Corinthians (6:15)** and **Galatians (2:17; 3:21; 6:14)**, but most frequently in **Romans (3:6, 31; 6:2, 15; 7:7, 13; 9:14; 11:1, 11)**, and his use of it often closely parallels its use in the Discourses of the Stoic philosopher **Epictetus**. Both Paul and Epictetus use the expression, for example, to reject a position and at the same time to initiate an explanation of why the position should be rejected. In Paul this subsequent discussion tends to focus on a certain topic such as “righteousness” (3:4–5) or “judgment” (3:6–8). . .

Thomas Schreiner: If salvific purposes exhaust the relationship between God and the Jews, then it is difficult to understand how any Jews would experience his judgment. In **verse 4b** Paul introduces the theme that God’s faithfulness and truth can’t be confined to his saving righteousness. God is also faithful to his promises in the judgment of his people. In other words, the saving righteousness of God does not rule out his judging righteousness. Even though God has promised salvation to the Jews, no individual Jew should presume upon those promises and think their salvation is guaranteed. God is still just and righteous when he judges sin among the Jews, for no individual is automatically granted God’s covenant mercies.

John Murray: The thought would appear to be as follows. Sin is directed against God and sin even against fellow men (as was David’s) is sin against them because it is first of all and ultimately sin against God; therefore God in his judgments upon men for sin is always just. And not only so. The character of sin as directed against God, and for the reason that it is directed against God, subserves the purpose of vindicating the justness of God’s condemnatory judgment. So far from detracting from the justice of God, sin as against God promotes the vindication and exhibition of his justice in the judgment he pronounces with reference to it. While this may appear to be harsh reasoning yet it is consonant with the subject the apostle has in hand. He has been making emphatic protestation to the effect that the unbelief of men does not bring to nought the faithfulness of God. The appeal to David’s confession provides him with the strongest kind of confirmation. For David had said that sin, since it is against God, vindicates and establishes God’s justice. If sin does not disestablish the justice of God, neither can man’s faithlessness and untruth make void the faithfulness and truth of God. God must be true though every man be a liar. That this is the apostle’s use and interpretation of **Psalm 51:4** the succeeding context indicates. For he proceeds forthwith to deal with the false inferences which opponents would

derive from the proposition that sin vindicates the justice and judgment of God—“*but if our unrighteousness commendeth the righteousness of God, what shall we say?*” (vs. 5).

B. (:5-6) He remains Just (manifesting His righteousness in action)

1. (:5) Is God’s Justice Nullified?

“But if our unrighteousness demonstrates the righteousness of God, what shall we say? The God who inflicts wrath is not unrighteous, is He? (I am speaking in human terms.)”

Frank Thielman: God is not unjust to punish those who sin, even if their sin results in the demonstration and verification of his righteousness.

Thomas Schreiner: Paul defends the thesis that even though the Jews possess salvific promises, they are not thereby exempt from moral responsibility and God’s judgment. In this sense **verses 5–8** explicate and defend more fully the theme broached in the citation of **Ps. 51:4** in **Rom. 3:4b**.

John Murray: There is one further expression in this passage that needs explication—“*I speak as a man*” (vs. 5). Paul is not to be interpreted as contrasting what he says now as a mere man with what on other occasions he says as an apostle or Christian. He is writing as an apostle. The thought is that in asking the foregoing questions he is accommodating himself to the human mode of interrogation and reasoning. In reality the questions are impertinent and out of place. For God’s justice is not something that may be called in question. And we may only utter these questions as voicing those that arise in the human mind and then only for the purpose of intimating the recoil of abhorrence from the very suggestion that God might be unjust. This is exactly what Paul does; he adds immediately the formula (cf. vs. 4 and note thereon) of emphatic negation, “*God forbid*”. The holiness and righteousness of God do not allow for calling his rectitude into question or for any suggestion of his inequity. It is that fundamental datum that Paul’s apologetic expression, “*I speak as a man*” underlines. It is for the purpose of repudiating the suggestion that he voices the questions.

2. (:6) May It Never Be!

“May it never be! For otherwise how will God judge the world?”

Lightning appears brightest when the sky is the darkest;
In the same way God's righteousness looks even better against the backdrop of darker sin.
But that does not make God inconsistent when He judges sin.
Sin can never be justified; only condemned.
Every Jew would grant that God is obligated to judge the world.

Frank Thielman: Paul backs up his denial that God is unjust in punishing the unjust by appealing to a principle Jews would have accepted as axiomatic: **God will judge the world**. Paul knows that in a Jewish context God’s judgment of the world is always just. God “*practices steadfast love, justice, and righteousness in the earth*” (**Jer 9:24**) and judges the peoples of the earth justly and equitably (**Pss 9:8; 96:10, 13; 98:9; Wis 12:12–13**). Just judgment, as the Scriptures define it, involves condemning the guilty and exonerating the innocent (**Gen 18:25; Exod 23:7**). Paul knows no other god than the God who views judgment as just judgment and who defines justice

in such a way that the unrighteous are condemned and punished. Paul’s point, then, is simply that if God is to judge the world at all (and the Scriptures affirm that he will), he must judge it justly. For the one true God, no other option is available.

C. (:7-8) Restatement and Conclusion -- final answer to the objectors:
the absurdity of the logical extension of their arguments

1. (:7) The Absurdity of the Argument against God's Truthfulness

“But if through my lie the truth of God abounded to His glory, why am I also still being judged as a sinner?”

2. (:8a) The Absurdity of the Argument against God's Righteousness

“And why not say (as we are slanderously reported and as some affirm that we say), ‘Let us do evil that good may come ‘?’”

Frank Thielman: If human unrighteousness and deceit somehow promote God’s reputation as righteous and truthful, then God should not punish the unrighteous. It is a short step from this sort of reasoning to the claim that one should intentionally do bad things in order to achieve good results. Paul assumes that his readers will be appropriately horrified at such a conclusion, and he frames the rhetorical question that articulates it so that it expects a resounding “no!”

3. (:8b) Conclusion

“Their condemnation is just.”

* * * * *

DEVOTIONAL QUESTIONS:

- 1) How have you appreciated and responded to the spiritual privileges that God has granted to you?
- 2) How are theological objections often a smokescreen for a heart that does not want to face accountability before God?
- 3) Why is it important that God demonstrate His faithfulness not only regarding promises of righteousness but of judgment?
- 4) How does this passage mesh with the arguments in **Romans 9-11**?

* * * * *

QUOTES FOR REFLECTION:

R. Kent Hughes: These were irrational, foolish arguments! Even so, they accurately represent the thinking of those who had the privilege of having the written Word of God but rejected it. I have heard unbelievers who were raised under the Word say things that are just as crass.

The truth is, our advantage is great in every way. First and foremost, we have the written self-revelation of God. We know what God is like—and the rest of the world does not. We know what we are like as well, but others without God’s Word lack this knowledge. We know what God’s standards are. It is hard for us to imagine what it is like to be without his Book. We have no idea what it is like to grow up without the Church. Some of us have great-grandparents, grandparents, parents, brothers and sisters, and spouses who all know Christ. Our massive advantage is not a thing to be trifled with. We should thank God every day for our incalculable advantage.

Thomas Schreiner: An explanation for this Jewish objection to his theology needs to be provided. **Why would they object to Paul’s theology of God’s judgment?** The key is to understand Pauline anthropology, since Paul has a radical theology of human corruption. When Paul speaks of the “*unrighteousness*” (ἀδικία, cf. **1:18, 29; 2:8**) of the Jews in **3:5**, it contains all the associations of human inability found in **1:18 – 3:4**. Some Jews believed that people were granted the ability to obey the law when God gave them free will (cf. Pss. Sol. 9.4–5; Sir. 15:11–20; 2 Esd. [4 Ezra] 8:55–57; 2 Bar. 54.15, 19; 85.7; m. Avot 3.16). What Paul implies in **Rom. 1–3** and makes explicit elsewhere is that human beings are unable to keep God’s law (cf. **8:5–8**) and God’s electing grace is their only hope for salvation (**Rom. 9–11**). This theme is adumbrated in what Paul says about every person being a liar and God being true in **3:4**. The Jewish objection to Paul’s gospel, then, was as follows (cf. **Räsänen** 1986: 198):

“Paul, your gospel teaches that the unrighteousness of Jews has a good end, in that it highlights God’s righteousness and justice in judging sinners. But the flaw in your theology is that the corruption of the Jews is so radical that the only way God can fulfill his saving promises to them is by a sovereign divine choice (cf. **Rom. 9–11**). If we Jews can do nothing to contribute to our own salvation and are fundamentally corrupt, then God is “*unrighteous*” (ἄδικος, adikos) to inflict his wrath on us.”

They protested that it was arbitrary for God to judge if the only hope for salvation was God’s electing grace. **Räsänen** (1986: 198) rightly says the justice of divine judgment in view of human inability is the real issue that informs the question in **verse 5**. He also remarks (1986: 197) that the question in **3:5** is parallel to the one asked in **9:14**, μή ἀδικία παρὰ τῷ θεῷ (mē adikia para tō theō, is there unrighteousness with God?). In **9:14** Paul responds with “*Certainly not*” (μὴ γένοιτο, mē genoito), because the thought of divine unrighteousness so repulses him. Similarly, in **3:5** he adds κατὰ ἄνθρωπον λέγω (kata anthrōpon legō, *I am speaking humanly*) and then adds μή γένοιτο in **verse 6** since even the suggestion of divine unrighteousness should scarcely be considered by finite creatures.

This reconstruction of the Jewish objection is plausible, since it is reasonable to ask how God could be righteous in condemning the Jews if they are frail creatures who have no ability to choose righteousness and their only hope is God’s grace. According to the interpretation suggested here, the question is pertinent and disturbing, demanding some kind of answer. Interestingly, the similar question about God’s justice in **9:14** has the same disquieting quality, for the previous argument in **9:6–13** also raises the question as to how God can be righteous. The parallel with **Rom. 9** is strengthened when one observes that **Rom. 3** addresses the same issue

raised in **Rom. 9–11**: whether the failure of the Jews to believe in the gospel calls into question the righteousness of God. . .

To sum up, **chapter 2** functions as a sustained attack on the adequacy of the old covenant. The Jews didn't obey the law sufficiently to inherit the salvation promised in the OT, proving that they were still enslaved to sin. They were under God's wrath in the same way as gentiles. But if this is so, then how can Israel's special election as God's people be accounted for, and was the covenant with the Jews a fabrication? These questions arise in **3:1–8**. One might expect Paul to reject the election of Israel, but he insists instead that God will fulfill his saving promises to Israel. **Räsänen** (1986: 202) says that Paul ends up in a muddle here. Paul wants to say that the Jewish covenant is ineffective and so they must believe in Christ, but he also says that the old covenant will be fulfilled and they will experience salvation. Yet Paul's answer is more complex than **Räsänen** allows. Thus God will shower his mercy on Israel as he pledged, but it does not follow from this that Israel is exempt from judgment. God also manifests his righteousness in judging Israel for their sin. How this works out is explained in more detail in **Rom. 9–11**, where Paul teaches that **God promises the salvation of a remnant**. The claim that **God's righteousness has both a saving and judging dimension** is crucial and comes to its climax in **3:21–26**. What Paul has accomplished in **3:1–8** is to **defend the thesis that Israel is still guilty for its sin, while affirming that the promises of their salvation will still be fulfilled**.

John Murray: So here his thought is that though the external rite is of no avail when it is accompanied by transgression of the law, yet this does not make void the advantage and profit accruing to the Jew as the depository of divine institution. The direction of the apostle's thought here is relevant as rebuke to much that is current in the attitude of the present day, namely, neglect of, if not contempt for, institutions which God has established in the church, on the plausible plea that in many cases those who observe these institutions do not prove faithful to their intent and purpose and that many who are indifferent and perhaps hostile to these institutions exhibit more of the evangelical faith and fervour which ought to commend these institutions. The same answer must be given and given with even greater emphasis. For if Paul could say with reference to the advantage and profit of an institution that had been discontinued as to its observance "*Much every way*", how much more may we esteem the institutions that are permanent in the church of Christ and which regulate its life and devotion until Christ will come again.

We should expect the apostle to specify several of the respects in which the advantage and profit of which he speaks actually obtained. He does this later in this epistle when he says that to Israel pertained "*the adoption, and the glory, and the covenants, and the giving of the law, and the service of God, and the promises*" (**9:4**). And we might all the more expect this when he begins by saying, "*first of all*"; we would naturally look for a second and a third. But this is not what we find. He gives us what is first and is content with that. It makes little difference whether we regard the word he uses as "first" or "chiefly". In either case what Paul appeals to is that which was preeminent in the privileges of the Jews—"they were intrusted with the oracles of God". They were the depositories of God's special revelation.

Steven Cole: If you contend with God, He will win and you will be condemned.

1. “Doesn’t your argument about being a Jew inwardly imply that there is no advantage in being a Jew?”

“No, because God entrusted His Word to the Jews.” (3:1-2)

2. “But doesn’t the unbelief of many Jews nullify God’s promises?”

“No, Jewish unbelief does not nullify God’s faithfulness to them or His right to judge their sin.” (3:3-4)

3. “But if our sin demonstrates God’s righteousness, how can He judge us for it?”

Paul replies, “But that argument would mean that God can’t judge even the Gentiles.” (3:5-6)

4. “But your teaching, Paul, implies that if my sinning abounds to God’s glory, not only should I not be judged; also, I ought to sin all the more.”

“That’s ridiculous! You just hung yourself!” (3:7-8)

Applications:

1. SPIRITUAL PRIVILEGES DO NOT GIVE YOU ANY ADVANTAGE WITH GOD IF YOU DO NOT RESPOND IN FAITH AND OBEDIENCE; RATHER, THEY INCREASE YOUR ACCOUNTABILITY TO GOD.

2. THE BIBLE IS A GREAT TREASURE THAT GOD HAS ENTRUSTED TO US. THEREFORE, WE SHOULD STUDY IT AND SEEK TO OBEY IT AS THE ONLY WISE WAY TO LIVE.

3. IF YOU ARE FIGHTING AGAINST GOD, YOU ARE FIGHTING A LOSING BATTLE. THE ONLY WAY TO WIN IS TO GIVE UP AND SUBMIT TO HIM.

4. BE CAREFUL NOT TO USE YOUR QUESTIONS AND OBJECTIONS AS AN EXCUSE FOR NOT REPENTING OF YOUR SIN AND TRUSTING IN CHRIST.

Bob Deffinbaugh: The Jew objects in this fashion to Paul’s argument: “From what you have said in chapter two, Paul, there is no practical benefit to being a Jew at all.” We might expect Paul to answer “yes” to this objection. Especially so if we adhere to **covenant theology**, which does not like to distinguish between Israel and the church. If Israel and the church are forever fused into one entity, and if all the promises of God to Israel are thus ‘spiritually fulfilled’ in the church, Paul would nearly have to agree that **Judaism offers no benefit any longer to the Jew.**

It would be inadequate for Paul to say that it was a privilege to be a Jew because they were formerly the custodians of God’s revelation. What profit is that to the Jew now? The advantage of being a Jew is that **God still has promises**, yet unfulfilled, for the nation Israel and they will be literally consummated. This we see in much fuller detail in **Romans chapter 11.**

Leedy Greek NT Diagrams:

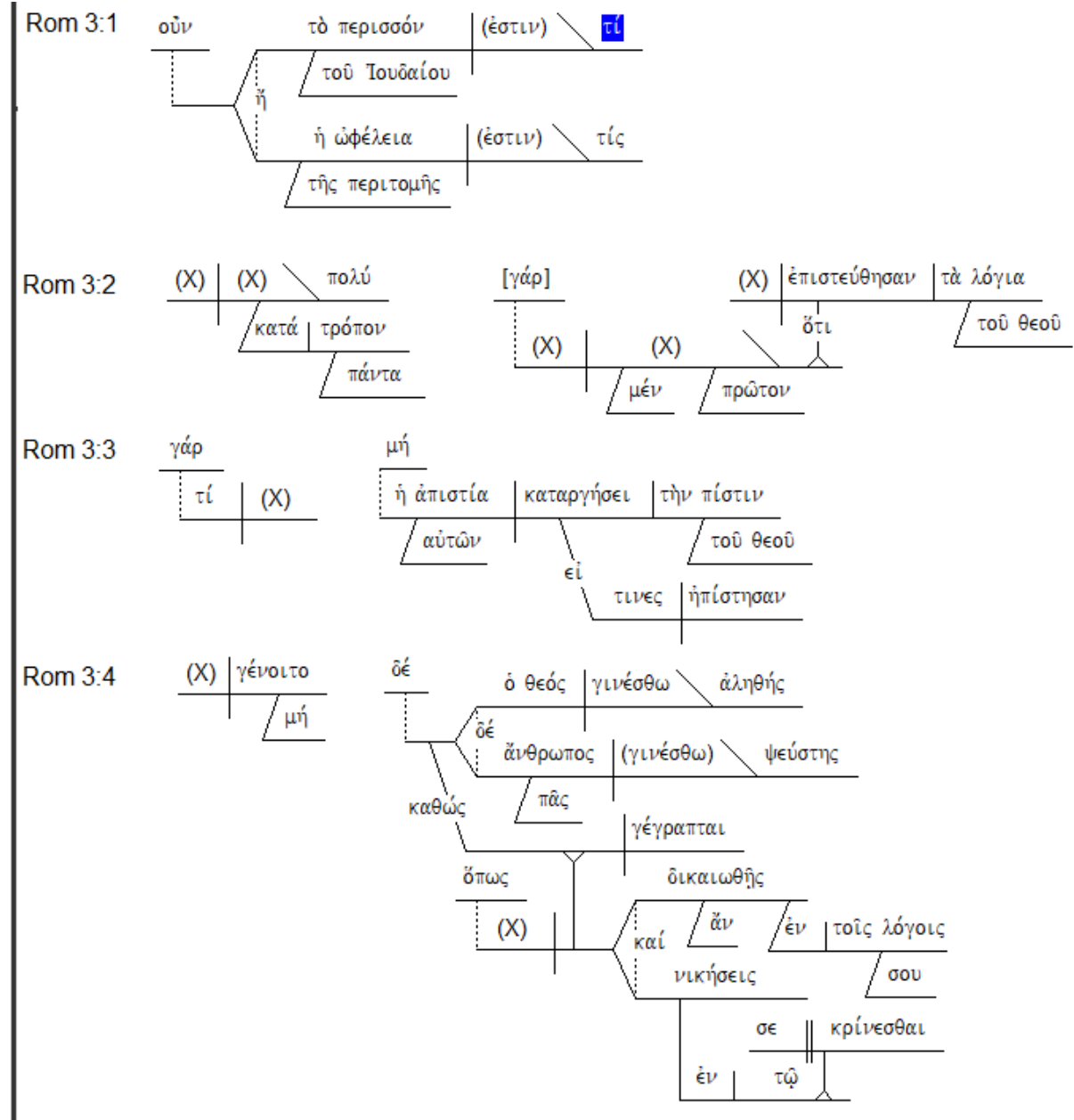

Rom 3:5

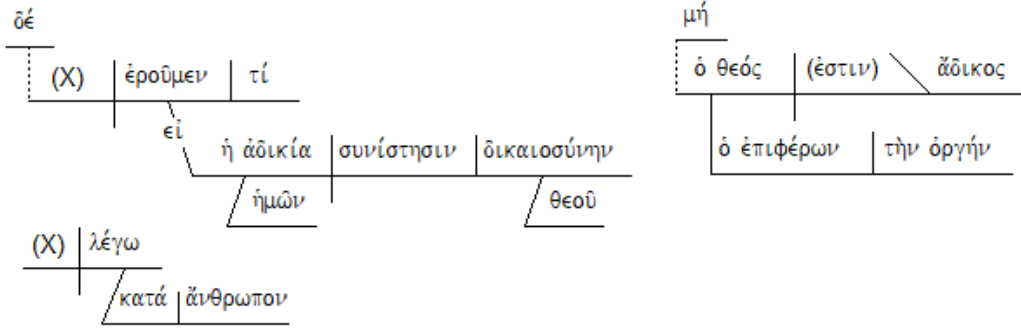

Rom 3:6

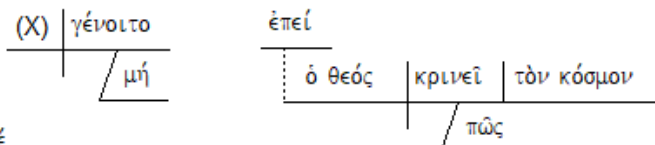

Rom 3:7

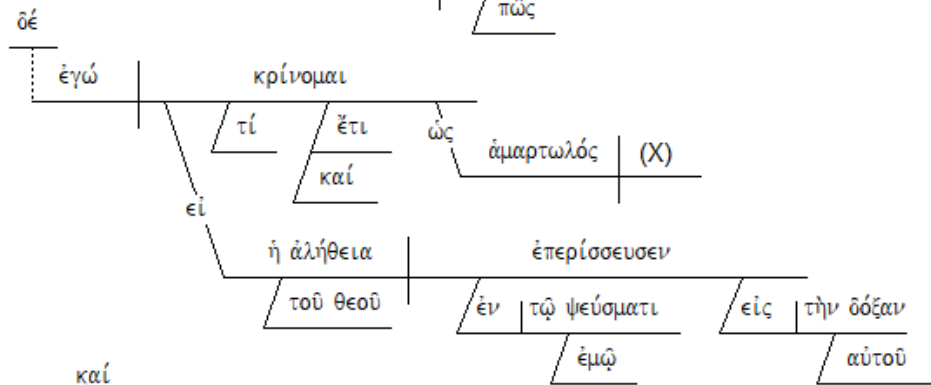

Rom 3:8

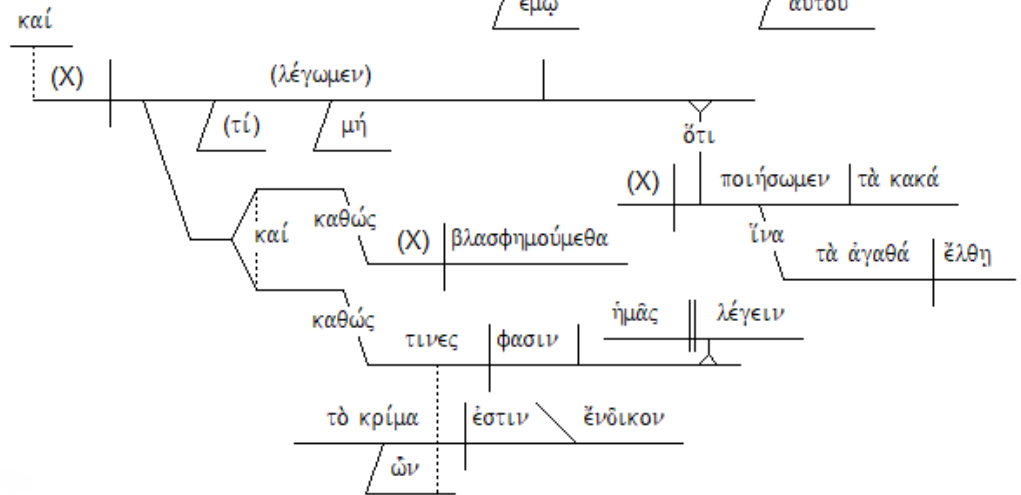

Frank Thielman:

- 1a Rhetorical Question **What, then, is the advantage of the Jew, or**
b Restatement **what is the benefit of circumcision?**
2a Measure **Much in every way!**
b Explanation For, first of all, that they were entrusted with the oracles of God.
- 3a Rhetorical Question **What, then?**
b Condition If some were unfaithful,
c Rhetorical Question **will their unfaithfulness cancel**
d Contrast **the faithfulness of God?**
- 4a Exclamation **Certainly not!**
b Assertion **Rather, let God be true and every human being a liar,**
c Comparison just as it is written,
OT Quotation "So that you may be justified
d Sphere in your words and
e Restatement win
f Time when you are judged." (Ps 51:4)
- 5a Condition But if our unrighteousness demonstrates the righteousness of God,
b Rhetorical Question **what shall we say?**
c Rhetorical Question **The God who inflicts his wrath is not unjust is he?**
d Assertion **(I speak in a human way.)**
- 6a Exclamation **Certainly not!**
b Rhetorical Question **Otherwise, how will God judge the world?**
- 7a Condition But if the truthfulness of God abounded
b Means by means of my lie
c Purpose for his glory,
d Rhetorical Question **why am I too still judged as a sinner?**
- 8a Rhetorical Question **And we should not do bad things that good things may come should we?**
b Comparison As we are slandered and
c Repetition as some claim that we say.
d Assertion **Their condemnation is just.**

TEXT: ROMANS 3:9-20

TITLE: TESTIMONY OF SCRIPTURE -- GUILTY AS CHARGED

BIG IDEA:

THE CONCLUSION: UNIVERSAL CORRUPTION LEAVES ALL MEN WITHOUT EXCUSE BEFORE GOD'S CONDEMNATION

INTRODUCTION:

The situation is worse than you think so stop trying to earn your salvation because you will never be good enough.

Frank Thielman: So far, however, Paul has demonstrated only that all social groups are under sin, taking both Jews and Greeks as representative of them all. He has not yet shown that every individual is **unrighteous**. He has described sin's deep entrenchment among Jews as well as gentiles, but he has not yet shown that no one is exempt from the charge that he or she is a sinner. It might even be possible to misunderstand certain sections of the argument in **1:18 – 3:8** to mean that some people would be justified on the final day by their faithful adherence to the law's commands (**2:6–10**; cf. **2:14–16, 26–27**). Probably to avoid this misunderstanding, in **3:9–20** Paul both summarizes his previous argument—that Jews are as unrighteous as gentiles—and takes the argument a step further to say that no one has kept God's requirements faithfully enough to merit justification before him on the final day.

With this concluding summary and intensification of his case in **1:18 – 3:8**, Paul brings the first major part of his argument to a close. He has shown that God's righteousness means the fair distribution of his wrath across social boundaries and, apart from the gospel briefly explained in **1:16–17**, the punishment of every individual for his or her sin. This prepares the way for his detailed explanation in **3:21 – 4:25** of how God's righteousness also means his saving power, distributed equally across social boundaries and to every individual on the basis of his or her faith. . .

Romans 3:9–20 can be divided into three sections.

- The first section introduces Paul's main point that no social group can claim any special privilege on the day of judgment because all are under sin (**3:9**).
- The second section proves this from Scripture, but takes the point even further by stating that no individual is free from the power of sin (**3:10–12**) and that sin pervades the existence of every individual (**3:13–18**). Sin wells up from within (**3:13a**), affecting one's speech (**3:13b–14**) and the direction of one's life (**3:15–18**).
- The third section draws the inevitable conclusion from the Scripture quotations in **3:10–18**—it is not possible to be declared just on the day of judgment by means of living morally, not even for a Jew who possesses the Mosaic law, since that law can only show one to be a sinner (**3:19–20**).

Douglas Moo: Paul now draws from his extended discussion of sin and God’s wrath in **1:18 – 3:8** a conclusion and an implication from that conclusion, both of which are foundational to his argument in the letter as a whole. The conclusion comes in **verse 9**: All people, including both Jews and Gentiles, are “*under sin.*” Paul states the implication at the end of the passage: “*No one will be declared righteous in his [God’s] sight by observing the law.*” Supporting the conclusion of **verse 9** is a series of Old Testament quotations—the longest such series in the New Testament (**vv. 10–18**).

I. (:9) EVERYONE (BOTH JEW AND GENTILE AND BELIEVER) IS IN THE SAME BOAT = “UNDER SIN” (AND THE BOAT IS DEFINITELY SINKING)

“What then? Are we better than they?”

Not at all; for we have already charged that both Jews and Greeks are all under sin;”

John MacArthur: Now immediately you're faced with one question. What is it? Who is the “*we*”? **Of whom is he speaking?** Many commentators feel he's speaking about the Jews. I tend to think not because he has just finished their section. And he has just answered the questions the Jews would ask in **verses 1** through **8**. He has already showed the Jews that they do have an advantage over the Gentiles in having the law of God. So why would he ask the same question again? Why would he be saying are we Jews any better, when he has just answered in verse 1 what advantage then has a Jew? And he's just shown that the Jew is really no better off even though he has the law of God. He's under a greater condemnation if he doesn't believe. Whether you're an immoral man, or a moral man or a religious Jew, you're under the same condemnation. They're all sinners. One is no better than the other. One may have the law of God written, one may have the law of God in conscience, but when it comes to guilt before God, they're all the same and they all need salvation.

I would also add that never in the rest of the epistle to the Romans does Paul identify himself with the Jew with a rhetorical “*we*.” Why would he do that here? I think the “*we*” here is the “*we*” that gathers up the only remaining people that he hasn't discussed and that would be **himself and the Romans** to whom he writes, which would be representative of the **believers**. And he's simply asking this question: Are we any better than these people? Are we any better than the immoral pagan, the moral religious man, and the religious Jew, who are condemned before God? Are we some kind of elite who are intrinsically better than everybody else? I think this fits with **verse 8** where you have a “*we*,” as “*we are slanderously reported and as some affirmed that we say.*” And there the “*we*” definitely refers to Paul and his companions in ministry. And so the question is very simple. Are we believers — now mark this very carefully — by nature? **Are we who are Christians, by nature in ourselves any better than the rest of the condemned world?** What's the answer? No. And that's what he says: No, in no way.

R. Kent Hughes: The force of the language here leaves no doubt about what is meant. The word is “*sin*”—not “*sins*”—and means “the dynamic of sin,” and “*under*” means “under the power or dominion of.” **Everyone in the world is under the power of the dynamic of sin!**

Douglas Moo: The problem with people is not just that they commit sins; their problem is that they are enslaved to sin.

Morris: He is regarding sin as a tyrant ruler, so that sinners are ‘*under*’ it (Jerusalem Bible, ‘under sin’s dominion’); they cannot break free.

II. (:10-18) HOW BAD IS IT? DESCRIPTION OF UNIVERSAL CORRUPTION

R. Kent Hughes: Paul substantiates his charge by stringing a series of Old Testament texts together. This is called a *charaz*, which literally means “stringing pearls.” He quotes six Old Testament sources in fourteen sweeping statements with devastating artistry.

David Guzik: These quotations from the Psalms (**Psalm 14:1-3; 5:9, 140:3, 10:7 and 36:1**) and from **Isaiah 59:7-8** all support this opening statement.

A. (:10-12) Corrupt in Nature

“*as it is written, There is none righteous, not even one;
11 There is none who understands,
There is none who seeks for God;
12 All have turned aside, together they have become useless;
There is none who does good, There is not even one.*”

Thomas Schreiner: Verses 10–12 hammer home the **universality of sin** five times with “*there is no one*” (οὐκ ἔστιν). The one line that lacks οὐκ ἔστιν contains “*all*” (πάντες), stressing again the **pervasiveness of sin**. The universal dimensions of the indictment are underlined in **verses 10 and 12** with the words οὐδὲ εἷς (*there is not even one*), and ἕως ἐνός (*not even one*), respectively. The **all-encompassing reality of sin** could hardly be put in stronger terms.

R. Kent Hughes: “. . . *no one seeks for God*” (v. 11). That is, no one by nature wants to know God. This is a verse that many Christians simply do not believe. Often we speak of someone we know who is “really seeking after God.” That just is not so! The word translated “*seek*” means “to seek out,” implying a determined search. Mankind does not search for God or the truth. Rather, he suppresses it and finally turns to idolatry (**1:18–23**). There is one exception: if the Holy Spirit is truly working in one’s heart, there is an authentic seeking.

“*All have turned aside; together they have become worthless.*” This describes the logical outcome of the preceding statements. Because no one has stayed on the path to God, they have become useless. They cannot fulfill their purpose as creatures made in the image of God. They are like fish that cannot swim or birds that cannot fly.

David Guzik: The word *unprofitable* has the idea of rotten fruit. It speaks of something that was permanently bad and therefore useless.

Steven Cole: Paul hammers the lid with so many nails that you cannot pry it open: *none* righteous; *not even one*; *none* who understands, *none* who seeks for God; *all* have

turned aside, *together* they have become useless; there is *none* who does good, there is *not even one!* Paul does not let anyone slip under the radar! We *all* have sinned.

John MacArthur: Not only is he **bad** but he is hopelessly **stupid**. When it comes to divine truth, men have a natural, innate **inability to understand the things of God**. In fact, we learned back in chapter 1, didn't we, that even in man's history, when he knows God, **verse 21**, and that's a very limited knowledge, when he knows there is a God and that God is powerful and supernatural, as we saw in **verse 20**, even when he knows that he refuses to glorify Him as God, is not thankful and immediately becomes empty in his thinking and his foolish heart is (What?) darkened. And what that is saying is that you can look at it two ways. You can look at it historically or you can look at it individually. Historically, originally man was given the knowledge of God and man by an act of his will turned out the lights. Individually, I believe people come into this world born with a sense of God in their conscience, with a sense of God visible through creation, and if they reject that then the last little flicker of God's revelation that exists even in conscience and creation is gone and the lights go out. But men in the midst of that stand up and announce that they're wise. Remember that? Which is the ultimate stupidity; as a blind man who goes around telling everyone that he can see when everyone knows he can't see at all. It's like the emperor's new suit, remember? Everybody knew he was stark naked but him. Darkened. Man is in blackness, he does not know the truth. He is blind.

B. (:13-14) Corrupt in Speech

*“Their throat is an open grave,
With their tongues they keep deceiving,
The poison of asps is under their lips;
14 Whose mouth is full of cursing and bitterness;”*

Frank Thielman: It is perhaps not accidental that Paul takes up so much space describing verbal sins in this part of his argument. He speaks of the throat, the tongue, the lips, and the mouth and how people often use them to wish harm on others and actually to do them harm (**3:13–14**). If we think about our own speech over the past day or week, it is likely that we will be less optimistic about our own basic decency and fairness. The image of the throat as an open grave implies that the harmful words we often use against others arise from hearts with a tendency toward sinfulness. *“How can you speak good,”* Jesus asked his opponents, *“when you are evil? For out of the abundance of the heart the mouth speaks”* (**Matt 12:34**).

Thomas Schreiner: The universal dimension of sin is nowhere more evident than in human speech (cf. **James 3:1–12**). In **Rom. 3:13–14** Paul employs **colorful images** from the OT to portray the **destructive character** of the tongue. The clause *“their throat is an open grave”* (τάφος ἀνεωγμένος ὁ λάρυγξ αὐτῶν, *taphos aneōgmenos ho larynx autōn*, v. 13) denotes either the inner corruption from which hurtful speech flows or the deadly effects of speech (**Cranfield 1975: 193**). The words *“they deceive”* (ἐδολιοῦσαν, *edoliousan*) concentrate on the falseness and flattery that permeate much of human speech. Even kind words may hide insidious purposes. We may flatter and praise others to advance ourselves. The **destructive nature** of communication is highlighted in *“poison of snakes”* (ἰὸς ἀσπίδων, *ios aspidōn*). Our speech toward others is deadly, cruel, and demonic. That the sins of the tongue are not occasional is conveyed in **verse 14**. Their

mouths are “full” (γέμει, gemei) of cursing (ἄρας, aras) and bitterness (πικρίας, pikrias). Resentment, malice, and words that cut down others are typical of human conversation.

C. (:15-17) Corrupt in Conduct

*“Their feet are swift to shed blood,
16 Destruction and misery are in their paths,
17 And the path of peace have they not known.”*

Thomas Constable: A sixth quotation, from **Isaiah 59:7-8** (cf. **Prov. 1:16**), appears in **verses 15-17**.

This passage is one of the most forceful in Scripture that deals with the **total depravity** of man. Total depravity does not mean that every person is as bad as he or she could be. It means that sin has affected every part of his or her being, and consequently there is nothing anyone can do to commend himself or herself to a holy God.

"Depravity means that man fails the test of pleasing God. He [sic It] denotes his unmeritoriousness in God's sight. This failure is total in that

- (a) it affects all aspects of man's being, and
- (b) it affects all people." [Charles Ryrie]

D. (:18) Fundamental Problem = No Fear of God

“There is no fear of God before their eyes.”

Mickelsen: This collection of OT quotations illustrates the various forms of sin, the undesirable characteristics of sinners, the effect of their action, and their attitude toward God. This is the same picture that Paul himself has been painting.

John Calvin: In short, as it [the fear of God] is a bridle to restrain our wickedness, so when it is wanting, we feel at liberty to indulge every kind of licentiousness.

Thomas Schreiner: The purpose of life is to fear and reverence God so that he is esteemed as holy and majestic and mighty. Sin at its heart decenters God; it degods God; it rejects his rule over our lives. The ferocity and brutality of human sin as described in **verses 13–17** might cause one to understand it primarily in sociological terms. Thus Paul reminds the reader that the root and basis of all sin is the failure to fear and reverence God. Sin is fundamentally theological in nature, but it has terrible social consequences. The barbarity of human beings to one another is ultimately explicable by a rejection of God and the failure to fear and honor him. . .

The OT texts that distinguished between the righteous and wicked are now applied to Jews who believed they were righteous, to prosecute the theme that all are guilty before God. By abolishing the distinction between the righteous and the wicked, Paul overturns the Jewish concept of covenant protection. The sin of the Jews places them in the same situation as the gentiles: guilty before God. The indictment of “all” as sinners is confirmed by the remarkable emphasis on **universality** noted earlier. Saying that “all” are under sin, both Jews and gentiles (**v. 9**), and excluding everyone from being righteous in such emphatic terms indicates that Paul speaks

universally. Indeed, we shall see that the all-pervasiveness of sin continues to be prominent in **verses 19–20**. Thus we can be assured that Paul intends to say that all, without exception, including the so-called righteous, are sinners and guilty before God.

III. (:19-20) THE LAW CAN NEVER SAVE – IT ONLY CONVICTS MEN AND LEAVES THEM WITHOUT EXCUSE BEFORE GOD’S CONDEMNATION

A. (:19) How is the Knowledge of the Law an Aid to Salvation?

1. Gets People’s Attention

“Now we know that whatever the Law says, it speaks to those who are under the Law,”

2. Eliminates All Excuses

“that every mouth may be closed, and all the world may become accountable to God;”

Frank Thielman: A day will come when all the world, Jews as well as gentiles, will give account to God for their evil and unjust actions. On that day no one will be able to defend themselves as innocent, and on that day God will bring injustice to an end.

B. (:20) How Is the Limitation of the Law Actually an Aid to Salvation?

1. Human Attempts to Keep God’s Righteous Standards Cannot Justify

“because by the works of the Law no flesh will be justified in His sight;”

Michael Bird: I prefer to describe the “*works of the law*” as referring to the Jewish way of life as codified in the Torah.

2. God’s Righteous Standards Increase Awareness of Sin and Create Sense of Need

“for through the Law comes the knowledge of sin.”

Douglas Moo: Having told us what the law cannot do—bring one into relationship with God—Paul concludes by telling us what the law does accomplish: Through it “*we become conscious of sin.*” “Become conscious” in the NIV translates the Greek noun *epignosis*, “*knowledge.*” But since “*knowledge*” in the Bible often refers to intimate acquaintance or understanding, the NIV rendering is on target here. By setting before people a detailed record of God’s will, the law makes people vividly aware of how short of God’s requirements they fall. It therefore brings **awareness of sinfulness**.

David Guzik: **J.B. Phillip**’s paraphrase of this phrase is striking. He writes, “it is the straight-edge of the Law that shows us how crooked we are.”

* * * * *

DEVOTIONAL QUESTIONS:

- 1) Why do many pastors shrink back from preaching hard-hitting messages on sin and man's **depravity**?
- 2) Some people like to argue that the concept of **fearing God** is relegated to the OT since the NT emphasizes God's love. How does this passage address that argument?
- 3) Why do we exhort people to **seek God** if the Scripture text asserts that no one seeks God on his own initiative?
- 4) What line of argument do you use in your witnessing to awaken the **awareness of sinfulness**?

* * * * *

QUOTES FOR REFLECTION:

Steven Cole: Why God Gave the Law

As we've seen in recent messages, the most difficult people to reach with the gospel are relatively "good" people, especially religious "good" people. They go to church. They are outwardly moral. They take pride in their good deeds. They think, "Sure, I've got my faults. Who doesn't? But, God knows that I'm a basically good person. Criminals and terrorists may deserve hell, but I'm not like they are." Filled with self-righteousness, they trust in their good works to justify them on judgment day. They don't see their need for a Savior from sin. And so they never repent of their sins and trust in Jesus Christ. . .

So Paul shows ("*we know*" appeals to something that is common knowledge, which even the religious Jews would agree with) that the Law speaks to all who are under it. Yes, God's Law condemns the Gentiles, too, so that "*the whole world may become accountable to God.*" But the Law speaks to those who are "*in the Law*" (literal translation), namely, **to the Jews**. He is showing that their own Law, in which they boasted, condemns them. They will not be justified by the Law unless they have kept it perfectly, which no one has. We can't expect to be justified by a law that we have only kept occasionally and have broken often. That is his closing argument before resting his case.

But this raises a question: Then why did God give the Law? Paul shows,

God gave the Law to reveal His standard of absolute righteousness to convict us all of our true guilt before Him, so that we would see our need for the gospel.

1. God gave the Law to reveal His standard of absolute righteousness.
 - A. THE TWO GREAT COMMANDMENTS SUM UP GOD'S ABSOLUTE STANDARD.

B. THE TEN COMMANDMENTS ELABORATE ON THE TWO GREAT COMMANDMENTS.

C. THE SERMON ON THE MOUNT REVEALS THAT GOD JUDGES US ON THE HEART LEVEL, NOT JUST ON EXTERNAL OBEDIENCE.

2. God's Law convicts us all of our true moral guilt before Him.

A. THE LAW CLOSES EVERY MOUTH.

B. THE LAW MAKES US ALL ACCOUNTABLE TO GOD.

C. KEEPING THE LAW CANNOT BE THE WAY TO JUSTIFICATION.

3. Our utter failure to keep God's Law should drive us to the gospel for salvation.

Conclusion:

Years ago, **Donald Grey Barnhouse**, the pastor for many years of Tenth Presbyterian Church in Philadelphia, used to ask those with whom he shared the gospel, "When you die and God asks, 'What *right* do you have to come into my heaven?' what will your answer be?" He was trying to get people to understand that their only right to heaven had to be that they were trusting in the Lord Jesus Christ and His death on the cross to pay for their sins.

On one occasion, an Arthur Murray dance instructor had been out late on a Saturday night. In the early hours of the morning, he stumbled back to his hotel room and fell into bed. The next morning, he was jolted awake by his clock radio, where the speaker asked, "If in the next few moments some great disaster should happen and you should be killed and if you should find yourself before God and he should ask you, 'What right do you have to come into my heaven?' what would you say?"

The question amazed and confounded the dance instructor. He had never heard such a question before. He realized that he didn't have an answer. His mouth was stopped. He sat silently on the edge of his bed while the speaker, Dr. Barnhouse, explained the answer. The dance instructor put his trust in Jesus Christ that day in his hotel room.

His name was **D. James Kennedy**. He went on to become the pastor for many years of the Coral Ridge Presbyterian Church in Fort Lauderdale, Florida. He also developed the Evangelism Explosion program that has led thousands to Christ by asking that question: "If you were to die today and God asked you, 'Why should I let you into my heaven?' what would you say?" (This story related by **James Boice**, *Romans* [Baker], 1:326-327.)

"Lord, I've tried to be a good person; I've done my best to keep the Golden Rule," won't cut it. "Lord, I'm a guilty sinner, but I put my trust in Your Son Jesus who died to pay my penalty," is the only answer that will be accepted. Make sure that your trust is in Christ alone!

Bob Deffinbaugh: All of this is viewed from the divine perspective. This is not to say that a man never does any thing good and kind for his fellow-man. Paul is not saying that men have no good thoughts or aspirations as judged by men. He is saying that man has nothing to commend himself to God. Man is incapable of doing anything to please God and to earn His approval, for man is born an enemy of God.

Michael Bird:

Recurring Vices in Romans 1 – 3	
Unrighteousness	1:18, 29; 2:8; 3:5, 10.
Wickedness	1:30; 2:9; 3:8.
Denying the truth	1:18, 25; 2:8; 3:4.
Without excuse	1:20, 29; 2:1.
Arrogance	1:22, 29 – 30; 2:1 – 5, 17, 21.
Rejecting God's glory	1:21, 23, 30; 2:23; 3:11, 18.
Debased thinking	1:21, 28, 31; 2:4; 3:11.
Sexual sins	1:26 – 28; 2:22.
Sins with idolatry	1:25; 2:22.
Violence	1:29, 30; 3:15.
Sinful speech	1:29; 3:7, 13 – 15.
Blasphemy	1:30; 2:24; 3:8.
Unfaithfulness	1:31; 3:3.
Sins in the heart	1:21, 24; 2:5, 15.
Strife	1:29; 2:8.

Leedy Greek NT Diagrams:

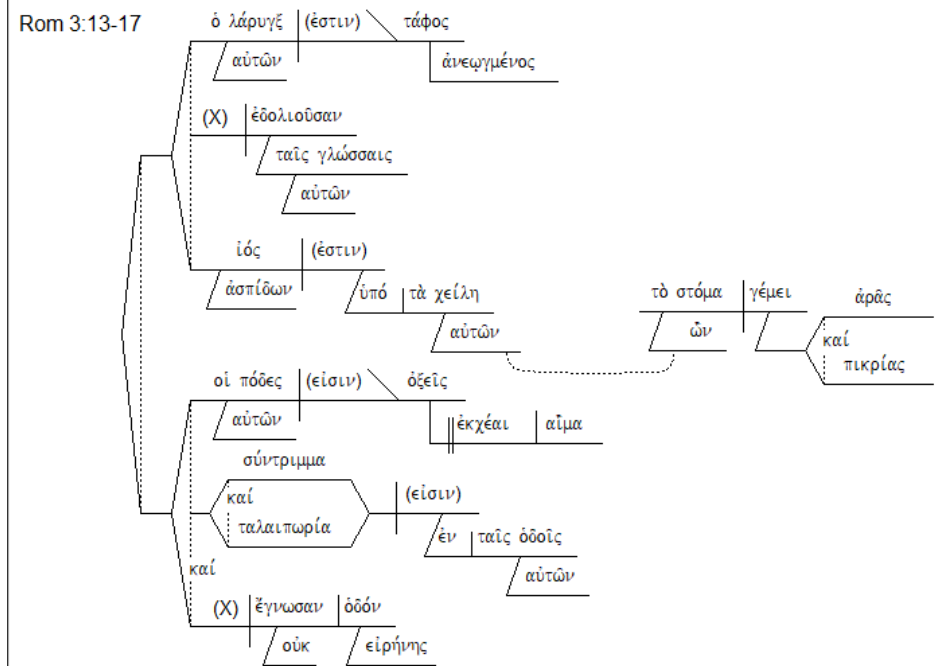
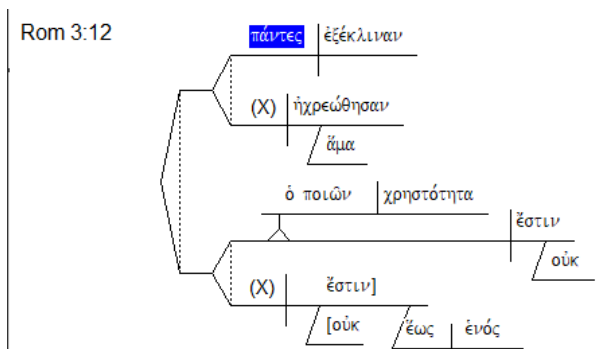
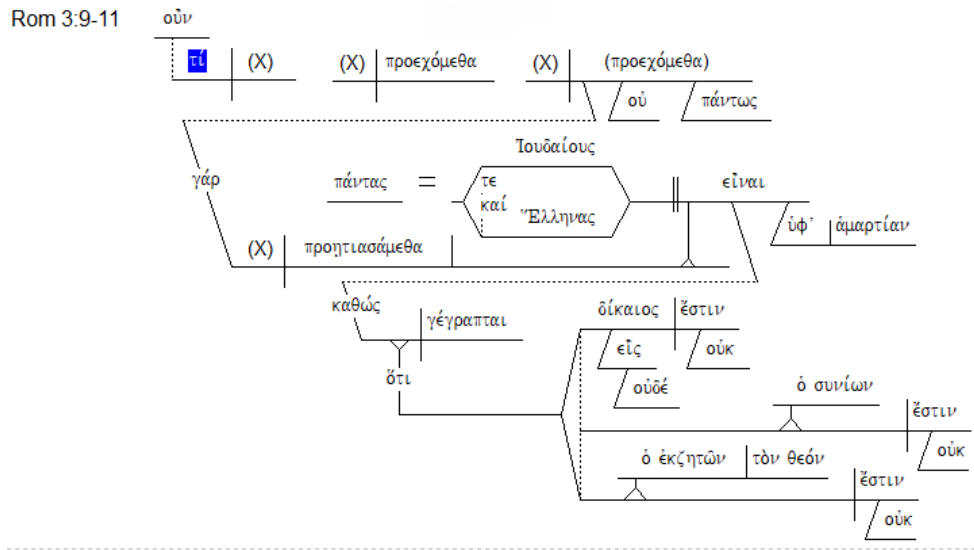

Rom 3:18

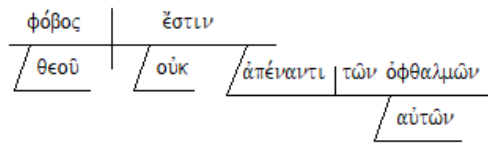

Rom 3:19-20

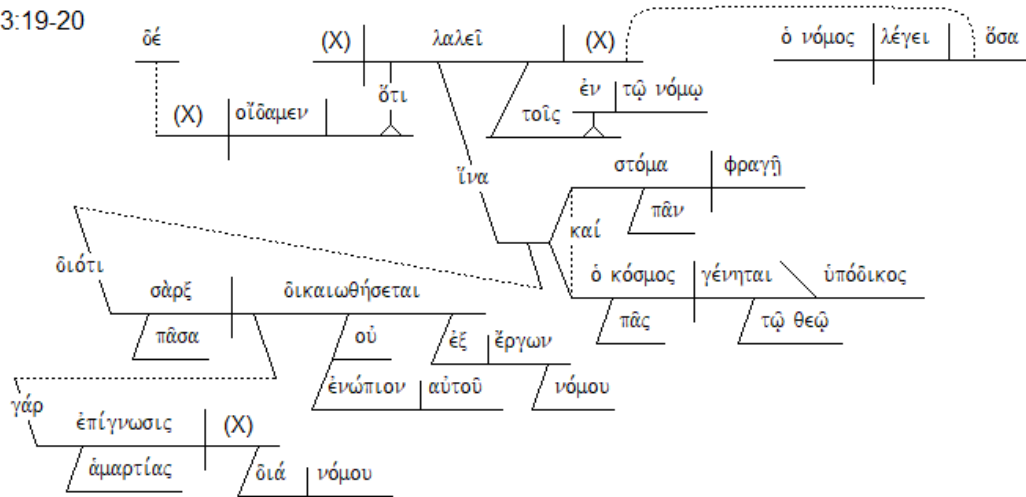

Frank Thielman:

- 9a Rhetorical Question **What then?**
- b Rhetorical Question **Are we surpassed?**
- c Exclamation **Not at all!**
- d Explanation **For we have charged beforehand that both Jews and Greeks—
all— are under sin**
- 10a Comparison
OT Quotation
Repetition just as it is written,
“There is no one righteous,
not even one.” (Ecc 7:20 LXX; Ps 14:1)
- 11a Assertion “There is no one who understands;
b Assertion there is no one who seeks after God.
- 12a Assertion All have steered clear;
b Assertion they have become useless together.
c Assertion There is no one who practices kindness;
d Assertion there is not even one.” (Ps 14:2–3)
- 13a Assertion “Their throat is an open tomb;
b Assertion with their tongues they were speaking deceit.” (Ps 5:9b)
c Assertion “The poison of cobras is under their lips.” (Ps 140:3)
- 14 Assertion “Whose mouth is full of cursing and bitterness.” (Ps 10:7)
- 15 Assertion “Their feet are quick to shed blood;
16 Assertion destruction and misery are in their ways,
17 Assertion and the way of peace they have not known.” (Isa 59:7–8)
- 18 Assertion “There is no fear of God before their eyes.” (Ps 36:1)
- 19a Assertion **Now we know that whatever the law says it speaks to those who are in the law**
b Purpose so that every mouth might be stopped and
c Repetition all the world become answerable ☞
to God.
- 20a Explanation of 19b–c For **by works of the law no flesh will be justified** before him (Ps 143:2),
b Explanation of 20a for **through the law comes the knowledge of sin.**

TEXT: ROMANS 3:21-31

TITLE: *THE GUTS OF THE GOSPEL*

BIG IDEA:

GOD MANIFESTS HIS RIGHTEOUSNESS IN PAYING THE PRICE TO JUSTIFY SINNERS BY GRACE THROUGH FAITH--THE GUTS OF THE GOSPEL

INTRODUCTION:

Frank Thielman: In **3:21–31** Paul returns to his definition of the gospel as the righteousness of God that powerfully saves those who believe and explains it in more detail. He focuses on two elements of the gospel.

- First, the gospel shows God’s fairness and impartiality, although it entails God declaring sinful people to be right with him.
- Second, the gospel excludes any form of human pride, whether pride in one’s performance or pride in one’s social status.

Main Idea: The righteousness of God powerfully saves sinful people from God’s wrath but maintains God’s fairness and impartiality through the sacrificial and atoning death of Christ. Like the mercy seat in the biblical tabernacle, Christ’s death on the cross was the “place” where God’s necessary and justified wrath against human rebellion ceased, allowing reconciliation between God and his people. That God took the initiative in this atoning sacrifice leaves no room for human boasting either in one’s achievements or in one’s social status.

Thomas Schreiner: Most scholars acknowledge this paragraph as the **heart of the epistle**. From **1:18** to **3:20** Paul has argued that all people deserve God’s wrath and judgment. Not even the covenant people are an exception, since they have failed to keep the Mosaic law. Indeed, the burden of **2:1–29**, which is summed up in **3:19–20**, is that even the covenant people failed to keep God’s law. Instead, the law reveals the transgressions of both Jews and gentiles. Thus reliance on the law or on Jewish distinctives is a false path. **Romans 3:21–26** turns the corner in the argument. The saving righteousness of God is not available through the law but has been revealed in Jesus Christ and his atoning death.

James Dunn: The **centrality** of this passage in the development of Paul’s argument is clearly indicated by the re-emergence of the two key terms in the thematic statement of **1:17**: δικαιοσύνη—**3:21, 22, 25, 26**; πίστις—**3:22, 25, 26, 27, 28, 30, 31**. . .

In exegetical analysis we mark off here the beginning of a new section of the overall argument, and it is clear enough that Paul at this point switches from indictment of all, Jew and Greek, to outline in fuller terms what his gospel actually says to this otherwise depressing analysis. But the transition does not involve a complete discontinuity in the thought, and it will be necessary to bear in mind the preceding context if we are fully to understand Paul’s exposition of his gospel. The point, which bears some reiteration, is that his gospel is good news precisely to the situation elaborated in **1:18 - 3:20**, the good news of God’s action on behalf of man, to and in the believer,

to establish him in the relation with God broken by man's (Adam's) unrighteousness and distorted by Israel's misunderstanding of the law.

I. (:21-26) GOD'S PLAN OF SALVATION FOCUSES ON THE GIFT OF HIS RIGHTEOUSNESS

Alva McClain: This section is the very heart of the book of Romans. For this reason, all Christians ought to memorize **verses 21-26**. If someone should ask me, "Brother McClain, if you could have just six verses out of the Bible, and all the rest be taken away, which would you take?" I would select these six verses. All of God's gospel is there, and in a way found nowhere else in the Word of God.

A. (:21) The Manifestation of the Righteousness of God

1. Revealed Now

"But now"

Frank Thielman: The passage begins with an expression ("*but now*" [νῦν δέ]) that alerts Paul's readers and hearers of a dramatic switch in the course of the argument. He is now about to describe in detail the saving righteousness of God that he had briefly mentioned in **1:16–17** and that answers the human plight he has just described at length in **1:18 – 3:20**. This contrasting section can be divided into two parts.

- The first part (**3:21–26**) consists of one long, complex sentence of high-sounding prose, a style that was fitting for the solemn announcement that God's saving righteousness was displayed in the atoning death of Christ Jesus.
- The second part (**3:27–31**) returns to the feisty give-and-take of the philosophical diatribe, a style that Paul had last used in **3:9**.

John Murray: **Meyer** contends that the "*now*" at the beginning of **verse 21** is not an adverb of time expressing "the contrast between two **periods**", but that it expresses the contrast "between two **relations**", namely, "the relation of dependence on the law and the relation of independence on the law". He does draw attention to the pivotal contrast instituted here between justification "through law" (which is nonexistent) and justification "without law" or "apart from law" which is the provision of the gospel and with which Paul proceeds to deal forthwith. But it is not apparent that the "*now*" in question should be deprived of its temporal force. Paul is emphasizing not only the contrast between justification through the works of law and justification without the law, that is, without works of law, but he is also emphasizing the **manifestation** of the latter which came with the revelation of Jesus Christ. *Now*, in contrast with the past, this righteousness of God is manifested; it has come to lie open to full view, as **Meyer** so admirably shows later on in his exposition. This does not mean for Paul that justification without the law was now for the first time revealed and that in the earlier period all that men knew was justification by works of law. It is far otherwise. To obviate any such discrepancy between the past and the present Paul expressly reminds us that this righteousness of God now manifested was witnessed by the law and the prophets. He is jealous to maintain in this matter as in other respects the continuity between the two Testaments. But consistently with this continuity there can still be distinct emphasis upon the momentous change in the New

Testament in respect of manifestation. The temporal force of the “*now*” can therefore be recognized without impairing either the contrast of relations or the continuity of the two periods contrasted.

2. Revealed Independently of the Principle of Law (e.g. earning by obeying)
“apart from the Law”

John Murray: The absoluteness of this negation must not be toned down. He means this without any reservation or equivocation in reference to the justifying righteousness which is the theme of this part of the epistle. This implies that in justification there is no contribution, preparatory, accessory, or subsidiary, that is given by works of law.

3. Revealed Openly in the Gospel and in the Person of Christ
“the righteousness of God has been manifested,”

Michael Bird: God’s righteousness describes the actions whereby God rectifies creation and shows himself faithful to the covenant. God’s righteousness is chiefly a way of designating his saving action as it is expressed in his feats of deliverance for his people. The righteousness of God then is the character of God embodied and enacted in his saving works. The principle benefit for humanity is that this new unveiling of God’s righteousness enables persons to be justified by faith in Messiah Jesus.

Note Paul’s emphasis that the revelation of God’s saving righteousness in the gospel is simultaneously discontinuous and continuous with the law. To begin with, when Paul says that the righteousness of God is manifested “*apart from the law,*” he means, first, that obedience to the precepts of the law is not the basis for access to salvation. In other words, performance of the works of the law, getting your Jewish lifestyle on, will not put you in the right. Second, adherence to the law does not demarcate the community who will experience God’s justifying verdict. The law is not a badge of covenant membership in the messianic age. Alternatively, “*the Law and the Prophets testify to*” this saving righteousness. According to **Brian Rosner**, Paul sees the law as possessing a prophetic function. The law (i.e., Torah) with its stories and sacrificial system all pointed ahead to the redemptive work of Israel’s messianic king.

Everett Harrison: **God’s righteousness**, that is, his method of bringing men into right relation to himself, is “*apart from law,*” which is agreeable to the declaration that the law operates in quite another sphere – viz., to make those who live under it conscious of their sin (v. 20).

4. Revealed in Harmony with the Testimony of the OT Law and Prophets
“being witnessed by the Law and the Prophets,”

Thomas Schreiner: The saving righteousness of God has become a reality through the work of Jesus Christ, not through the Mosaic law. It doesn’t follow from this that the OT is an inferior revelation. The OT repeatedly promises that God will fulfill his saving promises and looks forward to the day when they will become a reality

B. (:22) The Appropriation of the Righteousness of God

1. This Righteousness Comes from God
(we can't try to mix in our works)
“*even the righteousness of God*”

Thomas Schreiner: The “*righteousness of God*” (δικαιοσύνη θεοῦ) in **verses 21–22** is not a reference to the judging righteousness of God, in contrast to **Rom. 3:5**. The term reaches back to **1:17**, where the accent is on the saving righteousness of God that is revealed in the gospel. This saving righteousness . . . is forensic.

2. This Righteousness Only Requires Faith in Jesus Christ
(we can't try to mix in our works)
“*through faith in Jesus Christ*”

Thomas Schreiner: *Faithfulness of or faith in Jesus Christ?* More and more scholars dispute the idea that πίστις Ἰησοῦ Χριστοῦ refers to *faith in Christ*. The debate on this matter appears to be unending. Many now understand the genitive to be **subjective**, denoting the *faithfulness of Christ*. . .

Grammatically equivalent constructions in Paul reveal that an **objective sense** is plausible because Paul uses objective genitives as the object of a verbal action. We see examples of *hope in Christ* and *knowledge of Christ*, and thus it also makes sense to speak of *faith in Christ*. . .

The emphasis on faith in Jesus Christ is theologically important. In contrast to his opponents, Paul affirms that righteousness isn't obtained through obeying the law, since no one can practice the law sufficiently. Believing in Christ, not obeying the law, is the means by which the saving righteousness of God is received. The desire to underscore the centrality of faith explains why the faith of believers is inserted in verse 26. A. Hultgren (1980: 259–60) correctly argues that the contrast between believing and doing, which appears so often in Paul, suggests that believing in Christ is in view. The sustained emphasis on faith in Christ is present because it distinguishes Paul's gospel from that of his opponents. Typically, Second Temple Jews had a more optimistic view of human ability. By contrast, Paul asserts that human beings cannot obey the law.

An emphasis on human faith hardly detracts from the centrality of God's work in Christ (against **Keck** 1989: 454), since faith is explicitly distinguished from works and in Pauline theology is the consequence of election (**8:29–30**), and Paul also says faith is a gift of God (*Phil. 1:29; Eph. 2:8*). **Contextually**, then, an emphasis on faith in Christ makes good sense.

John Murray: In representing Jesus Christ as the **object of faith** the apostle brings to the forefront a consideration which had not been expressly stated so far in this epistle. The faith that is brought into relation to justification is not a general faith in God; far less is it faith without well-defined and intelligible content. It is faith directed to Christ, and when he is denominated “*Jesus Christ*” these titles are redolent of all that Jesus was and is personally, historically, and officially. . . Faith is focused upon him in the specific character that is his as Saviour, Redeemer, and Lord.

3. This Righteousness is Available without Favoritism

(the same plan of salvation applies to all -- Jew, Gentile, moralist, most corrupt)
“for all those who believe; for there is no distinction;”

John Murray: The glory of the gospel is that there is no discrimination in the favourable judgment of God when faith comes into operation. There is no discrimination among believers – the righteousness of God comes upon them *all* without distinction.

James Dunn: The πάντα is obviously the point of the repetition (the phrase is neither a mere repetition nor a new thought)—emphatic, both to balance the repeated “*all/every*” of vv 19–20 and 23, and at the same time to emphasize the universal outreach of God’s saving purpose and action (as in 1:5, 16; 2:10; 4:11, 16; 10:4, 11–13). See further on 1:16.

C. (:23) The Desperate Need for the Righteousness of God
“for all have sinned and fall short of the glory of God;”

Frank Thielman: God’s saving power and status of acquittal comes to anyone who believes because God, as a fair God, does not distinguish between social groups in administering his saving power. Everyone, without distinction, needs God’s righteousness because everyone, without distinction, has sinned and experienced the corrupting effects of sin.

John Murray: to come short of reflecting the glory of God, that is, of conformity to his image (cf. 1 Cor. 11:7; 2 Cor. 3:18; 8:23). . . We are destitute of that perfection which is the reflection of the divine perfection and therefore of the glory of God.

D. (:24-25a) The Redemptive Aspects of the Righteousness of God

1. (:24a) The Essence of Justification
“being justified as a gift by His grace”

Thomas Constable: Justification is an act, not a process. And it is something that God does, not man. As mentioned previously, justification is a **forensic** (legal) term. On the one hand it means to acquit (**Exod. 23:7; Deut. 25:1; Acts 13:39**). On the other positive side it means to declare righteous. But it does not mean to make one's behavior righteous. It means **to make one's position in the sight of God righteous.**

Warren Wiersbe: The characteristics of justification are that it is: apart from the Law (v. 21), through faith in Christ (v. 22a), for all people (vv. 22b-23), by grace (v. 24), at great cost to God (vv. 24b-25), and in perfect justice (v. 26).

Alva McClain: **Justify means to pronounce and treat as righteous.** It is vastly more than being pardoned; it is a thousand time more than forgiveness. You may wrong me and then come to me; and I may say, “I forgive you.” But I have not justified you. I cannot justify you. But when God justifies a man, He says, “I pronounce you a righteous man. Henceforth I am going to treat you as if you have never committed any sin.” Justification means sin is all past and gone – wiped out – not merely forgiven, not merely pardoned; it means clearing the slate and setting the sinner before God as a righteous man, as if he had never sinned, as if he were as righteous as the Lord Jesus Christ Himself.

2. (:24b) The Essence of Redemption

“through the redemption which is in Christ Jesus;”

Thomas Schreiner: The question is whether ἀπολύτρωσις involves the idea of a ransom paid in **Rom. 3:24**. Two lines of evidence converge to support the idea of a **price paid** (see esp. **Marshall** 1974).

- First, Paul says that all are justified “*freely*” (δωρεάν, dōrean). Human beings pay nothing to receive God’s righteousness. The freedom of justification, however, involves a cost on God’s part, since it was obtained “*through the redemption*” (διὰ τῆς ἀπολυτρόσεως) accomplished in Christ. The contrast between freely (δωρεάν) and the redemption provided by God suggests that the latter includes the idea of a price being paid.
- Second, the sacrificial character of the context points to the payment of a price. Whether one understands ἱλαστήριον as hailing from a cultic or martyrological background or both, the sacrificial dimensions of the term cannot be expunged (against **Hill** 1967: 75–76). The reference to αἷμα (haima, blood) in **verse 25** confirms that sacrificial motifs are employed here (cf. **Schnabel** 2015: 401). Since sacrifices involved the payment of a price (i.e., the blood of an animal) and since Paul elsewhere specifies that Christ’s blood was the price of redemption (**Eph. 1:7**; cf. **Acts 20:28**; **1 Cor. 6:20**; **7:23**), we should conclude that the payment of a price is intended here as well. **Büchsel**’s (TDNT 4:355) objection that ἱλαστήριον would be superfluous if a ransom were specified falters because the two themes together highlight the sacrificial quality of Christ’s death.

Hence, believers in Jesus are freed from their sins in that they are forgiven of their transgressions by virtue of his redeeming work.

John Murray: Justification is through the redemption that is in Christ Jesus; it is not through any price of ours; it is the costly price that Christ paid in order that free grace might flow unto the justification of the ungodly.

3. (:25a) The Essence of Propitiation

“whom God displayed publicly as a propitiation in His blood through faith.”

Michael Bird: There is widespread agreement among commentators that the background to this word comes from the sacrificial cultus prescribed by the Torah. The *hilastērion* designated the “*mercy seat*,” the cover of the ark of the covenant over which Yahweh appeared on the Day of Atonement, and over which the blood of sacrifices was poured (see **Exod 25:17 – 22**; **Lev 16:13 – 15**; **Heb 9:5**). This is why the NET opts for “*God publicly displayed him at his death as the mercy seat*.” The sacrificial context is underscored further by the reference to “*the shedding of his blood*” because it was the shedding of blood that made atonement for sins (see **Lev 17:11** and esp. **Matt 26:28**; **Eph 1:7**; **Heb 9:22**). By using this cultic imagery, Paul was “presenting Jesus as the ultimate ‘*mercy seat*,’ the ultimate place of atonement, and, derivatively, the ultimate sacrifice.”

Thomas Schreiner: The presence of propitiation doesn’t exclude the concept of expiation. Both are present in **3:25**. The death of Jesus removed sin and satisfied God’s holy anger. . .

That Jesus functioned as the priest, victim, and the place where the blood is sprinkled should not trouble us. Paul is trying to communicate that Jesus fulfills the sacrificial cultus, and the fulfillment transcends the cult. The sprinkling of Jesus's blood makes it possible for believers to meet with God. . .

Paul's employment of cultic terminology from the Day of Atonement signals a crucial theological judgment. The cultus of the temple is no longer effective (B. Meyer 1983: 206). The OT sacrifices cannot bring forgiveness; Paul implies that they simply foreshadowed the forgiveness effected through Jesus, since God patiently bore with sins committed during the Mosaic era. God looked ahead to the death of Jesus as the true sacrifice for sins. The salvation-historical dimension of Pauline theology emerges here. Those who revert to the law for righteousness will be disappointed because the atonement provided in the law does not really forgive. Only Jesus's death satisfies God's wrath. The saving righteousness of God, therefore, cannot be obtained through the law. The exclusive means of becoming right with God is through faith in Jesus the Messiah.

John Murray: Redemption contemplates our bondage, and is the provision of grace to release us from that bondage. **Propitiation** contemplates our liability to the wrath of God and is the provision of grace whereby we may be freed from that wrath.

David Thompson: The term "*propitiation*" (*ilasthriōn*) is one that refers to the actual means and point of appeasing that satisfies all the demands necessary to be right with God.

The question on this doctrine is **what needs appeasing**. **Dr. Ryrie** thought it was the wrath of God that needs to be appeased (Basic Theology, p. 294). **Dr. Chafer** believed it was the righteousness of God and the law of God that needed to be appeased (Systematic Theology, Vol. 3, p. 93). That was basically the same view as **C. I. Scofield** (Ibid., p. 95). We think the propitiation satisfies the demands of and appeases the righteousness of God and the violated O.T. law of God.

E. (:25b-26) The Vindication of the Righteousness of God

"This was to demonstrate His righteousness, because in the forbearance of God He passed over the sins previously committed; 26 for the demonstration, I say, of His righteousness at the present time, that He might be just and the justifier of the one who has faith in Jesus."

James Dunn: "*in the forbearance of God.*" The phrase simply strengthens the clear implication of the preceding phrases that whatever the rationale of God's not pressing for punishment of the sins committed by his covenant people in the preceding epoch (whether the sacrificial system "worked" or merely foreshadowed Christ's sacrificial death), it was an act of divine forbearance or "*restraint*" (Williams, Saving Event, 28). The thought was hardly strange to Jewish ears (cf. particularly the often repeated theme of **Exod 34:6-7**—see on **9:15**, and further **11:31, 32**; **Wilckens**; and further **Zeller**, "Sühne," 64-70); yet it would be easy to fall into the habit of taking that forbearance for granted simply because the sacrificial system was so well established

Frank Thielman: God intended Christ's death to prove that, although he had kindly dismissed the sins of his people prior to the death of Christ, he had not ceased to be committed to the impartial and fair administration of justice.

Thomas Schreiner: What Paul argues in these verses is that God vindicates his righteousness in the cross. He satisfied his wrath in sending his Son as a substitute for sin, to demonstrate that the passing over of former sins was not because he winked at sin. He tolerated the sin of human beings only because he looked ahead to the death of his Son as an atonement for sin. In the present era of salvation history (ἐν τῷ νῦν καιρῷ, **3:26**) God's righteousness has been vindicated in the death of Jesus. These comments by Paul make clear that the question he asked was not How can God justly punish human beings? His question was rather **How can God justly forgive anyone?**

Verses 25–26 also solve the problem that has been building since **1:17**. How do the saving righteousness and the judging righteousness of God relate to each other? How can God mercifully save people without compromising his justice? Paul's answer is that in the death of Jesus, the saving righteousness and judging righteousness of God meet. God's justice (εἰς τὸ εἶναι αὐτὸν δίκαιον) is satisfied in that the death of his Son pays fully for human sin. He can also extend mercy (καὶ δικαιοῦντα τὸν ἐκ πίστεως Ἰησοῦ) by virtue of Jesus's death to those who put their faith in Jesus. To be more specific, the καὶ joining the last two clauses is probably concessive (**Cranfield** 1975: 213; **D. Moo** 1991: 243) or perhaps expegetical (so **Linebaugh** 2013: 148–49n80). God is just even in justifying the one who has faith in Jesus. **Piper** (1983: 127–30) is also correct in seeing the fundamental issue as the glory of God's name. Even though, against Piper, God's righteousness should not be defined as his desire to maintain his glory, the desire for his glory undergirds his desire to demonstrate his righteousness. **Romans 1:18–32** indicates that the gentiles experienced God's wrath because they scorned his name, and that the Jews dishonored his name among the nations (**2:24**). By demonstrating his saving righteousness and his judging righteousness, God has vindicated his name before the world so that all those who believe receive forgiveness of sins.

II. (:27-31) GOD'S PLAN OF SALVATION LEAVES NO ROOM FOR A SPIRIT OF PRIDE – A REFUTATION OF 3 PRIDEFUL QUESTIONS

Thomas Schreiner: The paragraph has three major points.

- First, since righteousness is based on faith in what God has accomplished in Christ (**vv. 21–26**) and not human works, boasting is ruled out (**vv. 27–28**).
- Second, the oneness of God demands that Jews and gentiles are justified in the same way: by faith (**vv. 29–30**).
- Third, Paul concludes (οὖν, oun, therefore) that faith does not nullify the law but establishes it (**v. 31**).

James Dunn: Following the log-jam of prepositional phrases and somewhat tortuous syntax of the preceding paragraph (**vv 21–26**), the **change of style** is abrupt. The staccato interchange of brief question and answer would give relief after the intensity of concentration required to catch the full force of what had obviously been a major statement of the letter's central theme. The

change is certainly deliberate and shows Paul's awareness of the need to vary his style in order to retain the attention of those listening to his letter read out.

A. (:27-28) What about Boasting in Works?

Faith Leaves No Room for Boasting in Our Own Accomplishments

“Where then is boasting? It is excluded.

By what kind of law? Of works? No, but by a law of faith.

28 For we maintain that a man is justified by faith apart from works of the Law.”

David Thompson: When it comes to justification, man's big mouth cannot boast or brag about one thing because it is all a grace gift found in Jesus Christ. You cannot brag about your works or commitment or your discipleship or obedience because it has nothing to do with God's justification. **Human boasting finds no place in grace salvation.** Why? Because grace salvation is found in Jesus Christ and it is His righteousness that is imputed to us and it has nothing to do with our righteousness. He is our redemption and He is our propitiation and He is our justification.

B. (:29-30) What about Boasting in Ethnicity?

The Oneness of God Means a Universal, Common Plan of Salvation that Leaves No Room for a Spirit of Exclusivity

“Or is God the God of Jews only? Is He not the God of Gentiles also?

Yes, of Gentiles also, 30 since indeed God who will justify the circumcised by faith and the uncircumcised through faith is one.”

John Murray: Identity of principle in his saving operations follows from the unity of his relationship to all as the one God of all (cf. **Isa. 43:11; 45:21, 22**).

John Witmer: The next two questions cover the same issue of Jewish distinctiveness from a different angle. Because the Gentiles worshiped false gods through idols, the Jews concluded that Yahweh, the true and living God (**Jer. 10:10**), was **the God of Jews only**. That was true in the sense that the Jews were the only people who acknowledged and worshiped Yahweh (except for a few proselyte Gentiles who joined with Judaism). But in reality Yahweh, as the Creator and Sovereign of all people, is the God of all people. Before God called Abraham and his descendants in the nation Israel to be His Chosen People (**Deut. 7:6**) God dealt equally with all people. And even after God's choice of Israel to be His special people, God made it plain (e.g., in the Book of Jonah) that He is the God of everyone, **Gentiles** as well as Jews. And now since there is *“no difference”* among people for all are sinners (**Rom. 3:23**) and since the basis for salvation has been provided in the sacrificial death of Jesus Christ, God deals with everyone on the same basis. Thus there is only one God (or *“God is one”*). Paul no doubt had in mind here the “Shema” of Israel: *“Hear, O Israel: The Lord [Yahweh] our God [Elohim], the Lord [Yahweh] is One”* (**Deut. 6:4**). This one God over both Jews and Gentiles **will justify all** who come to Him regardless of background (**circumcised** or **uncircumcised**) on the same human condition of faith.

C. (:31) What about the Role of the Law -- Is the Law then Worthless?

The Value of the Law Leaves No Room for a Spirit of Independent Lawlessness –

Instead, Justification by Faith Should Motivate Holy Living

*“Do we then nullify the Law through faith? May it never be!
On the contrary, we establish the Law.”*

Frank Thielman: Paul anticipates an objection from what he has said so far about the lack of any role for works or social identity in justification. Does this mean that faith in the gospel cancels the law (**3:31a**)? This was not the place for an extended answer to that question, but he briefly denies that its implication is true (**3:31b–c**) in anticipation of what he will say later in **7:7 – 8:17**.

John Murray: Paul is well aware of the danger of the antinomian inference from the doctrines of grace. He deals with it in detail in chapter 6 and offers the arguments which not only refute it but reduce it to absurdity. But here he anticipates the objection and he answers it summarily. The summariness is eloquent. He is guarding against a distortion which cannot be granted a moment’s toleration.

Alva McClain: There is only one religion in all the world that can save men and still establish, exalt, and honor the law: Christianity. All other systems that are based on legality, on salvation by works, dishonor the law, because nobody ever kept it. The inevitable result is that they pull the law down a little bit so that man can win his salvation by keeping it. But God punished Christ, His Son, for our transgression, and in so doing, He not only saves us, but at the same time he also establishes His throne in the heavens as a throne of justice and mercy.

* * * * *

DEVOTIONAL QUESTIONS:

- 1) Why are these verses so key to the Apostle Paul’s argument in the Book of Romans?
- 2) How can you explain justification as a judicial action rather than as a lifelong process?
- 3) How does our pride tempt us to boast in our own achievements or merit?
- 4) If people are not capable of exercising faith in Christ on their own, how can God command them to believe?

* * * * *

QUOTES FOR REFLECTION:

Michael Bird: Paul’s exposition of the revelation of God’s righteousness in **3:21 – 31** brings together massive themes from the story of Scripture. There is imagery drawn from the exodus, the Day of Atonement, and Isaiah’s prophetic word to the exiles. There is the picture of sin as glory lost and lacking. Paul describes the saving nature of Jesus’ death with a triangulation of biblical themes of redemption, atonement, and justification. We also meet here for the first time in Romans the motif of union with Christ. Then there is the law as pointing to salvation but not

itself providing it. Paul soars in between anthropological, christological, and redemptive-historical horizons. Thus, **3:21 – 20** is the cross section of so many biblical stories and presents Christ as the climax of God’s saving purposes.

Douglas Moo: One of the striking things in these verses is that they are **objective** in their orientation. That is, they do not say much about a difference in the way we may feel. They focus on the **difference of who we are in God’s sight**. A basic theme of Romans, coming to expression again and again in the letter, is the need for Christians to understand who they are. Paul will say much more on this subject in **chapters 5–8**. But he lays the foundation here by reminding us of the great turning point in world history: the revelation of God’s righteousness in Christ, inaugurating a new age in which a restored relationship with the God of the universe is available for all.

R. Kent Hughes: What is the miraculous arrangement whereby profoundly corrupt sinners can be made just before a holy God? This is possible for three reasons, stated consecutively in **verses 21–26** of our text. The first is in verse 21, where we see that the miracle of justification is possible because a special righteousness exists separate from the works of the Law.

I. The Miracle of Justification: Righteousness Apart from the Law (v. 21)

The Law pointed to this radical righteousness as mankind kept falling short of the Law’s commands. Along with this, the Law’s insistence on blood sacrifice reminded mankind that the works of righteousness would never be enough. . .

The greatest display of this radical righteousness was of course the **life of Christ**. From a human perspective Jesus Christ achieved eternal life through sheer merit. He is the only man who ever deserved eternal life simply by the way he lived. Jesus is the radical righteousness of God! As Paul says in **1 Corinthians 1:30**, “*You are in Christ Jesus, who became to us wisdom from God, righteousness and sanctification and redemption.*”

II. The Miracle of Justification: Righteousness by Faith (vv. 22, 23)

As radically corrupt sinners, we rise from helplessness to hope when we see that a righteousness exists apart from the Law. And our hope skyrockets when we see that our righteousness comes through faith. Everyone who believes will have it!

III. The Miracle of Justification: Righteousness from Christ’s Work (vv. 24–26)

Steven Cole: Understanding Biblical Propitiation

But we need to understand several things that distinguish biblical propitiation from the pagan expressions of it. In pagan religions, the person who is experiencing some difficulty assumes that he has offended the gods in some way, but he often doesn’t know how. The gods are unpredictable, but something apparently got them upset! And, he’s not quite sure which sacrifice will work to calm down the gods so that he or his family can get relief from their troubles. But the shamans have more experience with these sorts of things. So the troubled man pays them their fee, offers the prescribed sacrifice, and hopes that the deities will be happy for a while. His sacrifice is an attempt to propitiate the gods.

But biblical propitiation is much different. In the first place, God's wrath against sin is not capricious or mysterious. Rather, **it is His settled holy opposition to evil, expressed in both temporal and eternal judgments.** We see the temporal consequences of God's wrath in both the Old and New Testaments. God cast Adam and Eve out of the garden and pronounced curses on them, on the earth, and on the serpent because of their sin. He sent the flood to destroy everyone on earth in the days of Noah. He rained fire and brimstone on the decadent people of Sodom and Gomorrah. However you interpret the Book of Revelation, it's clear that God's temporal judgments were not limited to the Old Testament. He pours out His wrath on rebellious people right up to the time of Christ's return. That same book shows what Jesus often taught, that God's temporal wrath will turn into horrible, eternal wrath at the final judgment.

We've already seen the concept of God's wrath in Romans. In **1:18**, Paul wrote, "*For the wrath of God is revealed from heaven against all ungodliness and unrighteousness of men who suppress the truth in unrighteousness.*" We saw that a large part of God's presently revealed wrath against sin is to let us suffer the consequences of sin, as described in **1:24-32**. In **2:5**, Paul refers to God's wrath as it pertains to eternal judgment: "*But because of your stubbornness and unrepentant heart you are storing up wrath for yourself in the day of wrath and revelation of the righteous judgment of God.*" Again in **3:5**, he mentions "*the God who inflicts wrath.*" So the concept of propitiation as the satisfying of God's wrath is not foreign to the Bible or to Romans.

But there is another major difference between the pagan concept of pacifying the anger of the gods and the biblical concept of propitiation. In the pagan religions, people take the initiative by offering sacrifices in an attempt to placate the gods. But in the Bible, **God takes the initiative** by providing the specific means of averting His wrath on sin. First, God always spells out what sin is, so that no one should accidentally do something to make God angry. He warned Adam and Eve not to eat the fruit of the tree of the knowledge of good and evil and He spelled out the consequences that would follow if they disobeyed: they would die. The same is true in the Law of Moses. God spells out what Israel should do or not do, along with the consequences for disobedience.

Also, in mercy God provides the way to satisfy His wrath and be reconciled to Him. He slaughtered an animal and provided their skins to clothe Adam and Eve. He told Noah to build the ark to preserve his family and him from the flood. He provided the ram, so that Abraham did not have to sacrifice Isaac. He gave detailed instructions to Moses about the sacrificial system. And, finally and supremely, by sending His own Son to die in our place on the cross, God satisfied His own wrath against our sin. Jesus paid the debt that we owed, so that God can show His grace and love to all that trust in Jesus Christ.

Paul makes this clear by the phrase, "*whom God displayed publicly.*" Other versions read, "*set forth*" (New KJV), "*presented*" (NIV, Holman CSB), and "*put forward*" (ESV). The verb that Paul uses can also mean to purpose or plan beforehand (**Rom. 1:13; Eph. 1:9**; the noun is used in **Rom. 8:28; 9:11; Eph. 1:11; 3:11**) and some scholars argue for that meaning here. It would then mean that God planned beforehand to provide Jesus as the propitiation for our sins. But it also can mean to display or set forth publicly. In this view, God's setting forth or displaying Jesus as a propitiation would refer to His public death on the cross or to the apostolic preaching

of the cross. Whichever view is correct, they both point to the fact that **God took the initiative** in providing the sacrifice that we need to satisfy His wrath.

Grant Osborne: HOW CAN GOD ACCEPT US?

The Problem

We resist God.

We ignore God.

We attempt to deceive God.

We work against God's interests.

We acknowledge God only when we are in trouble.

We consider our plans and desires before God's.

We do not love God with all our heart, soul, and mind.

How can we even hope to have an intimate relationship with God, or to go to heaven after this life?

False Solutions:

Deny there is a God, but create our own god out of something or someone else.

Live in guilt, punishing ourselves or masking the guilt behind alcohol and drugs.

Use religion (works, church attendance, service) as a substitute for faith, loving God, and obeying him.

Assume or vaguely hope God will save us anyway.

Conclude God is too demanding and live in despair or apathy.

True Solution:

Recognize the answer to our problem is faith and trust in Christ.

Accept God's gracious gift of forgiveness, believing in his love.

Realizing that God is willing to declare us not guilty, and that he alone can do that.

Live in the freedom provided by God, enjoying the opportunity to express our thanks by obedience rather than trying to earn his acceptance.

Humbly accept the fact that Christ's substitution for us accomplished what we could not have done for ourselves.

Leedy Greek NT Diagrams:

Rom 3:21-22a

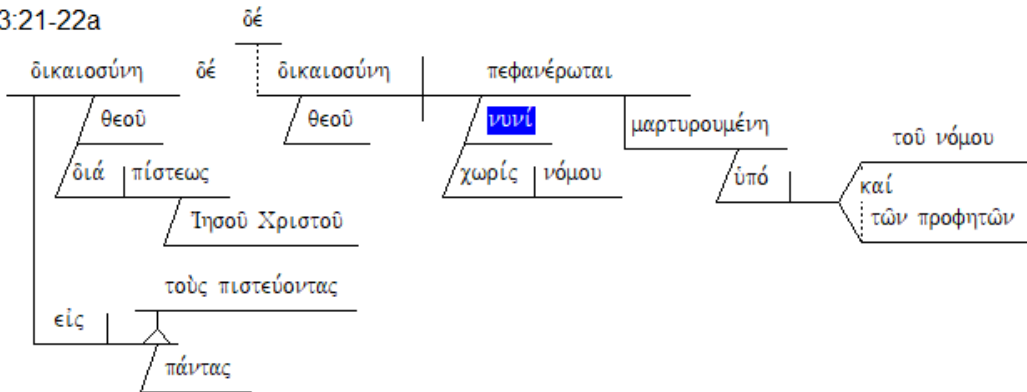

Rom 3:22b-26

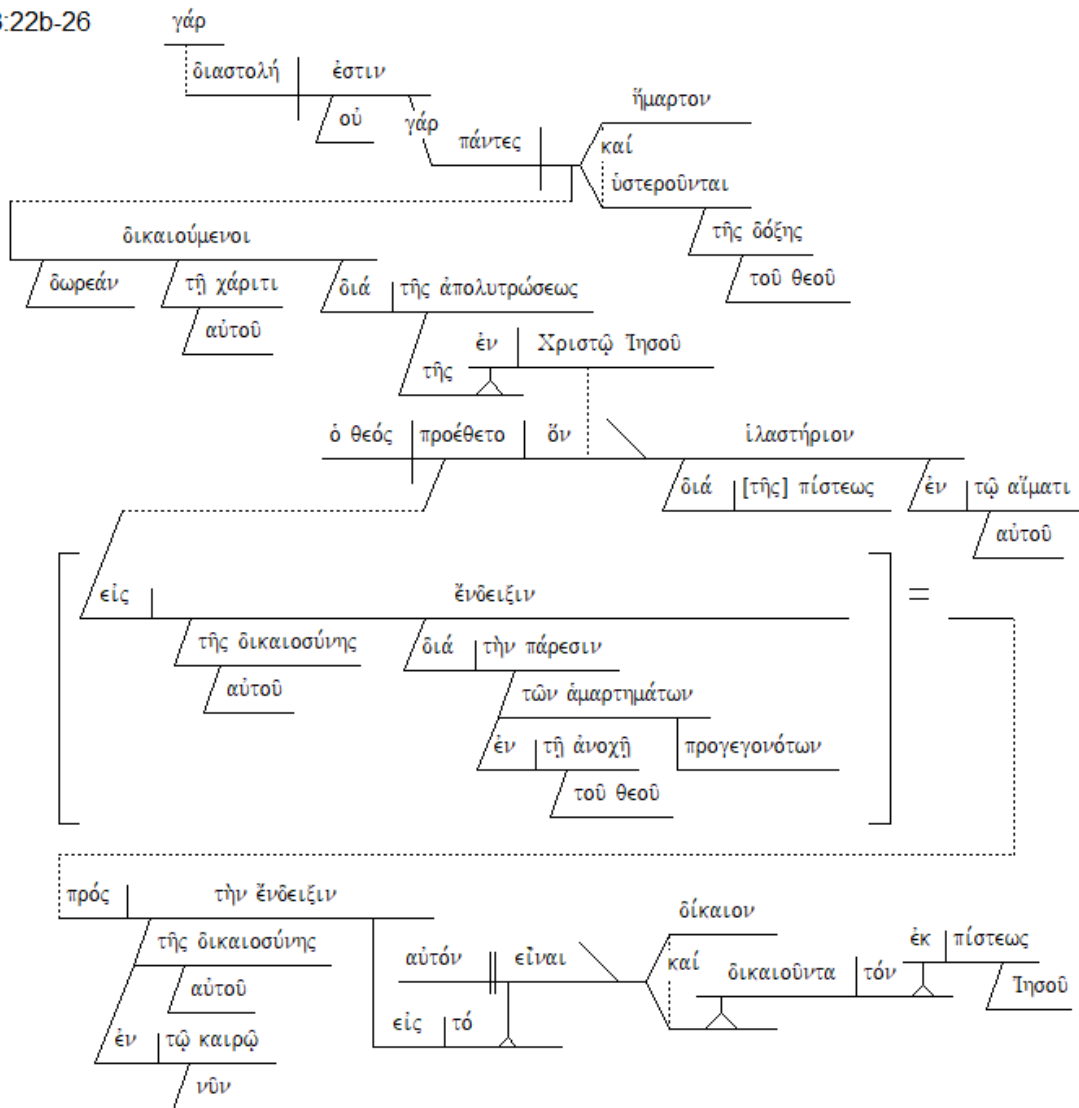

Rom 3:27

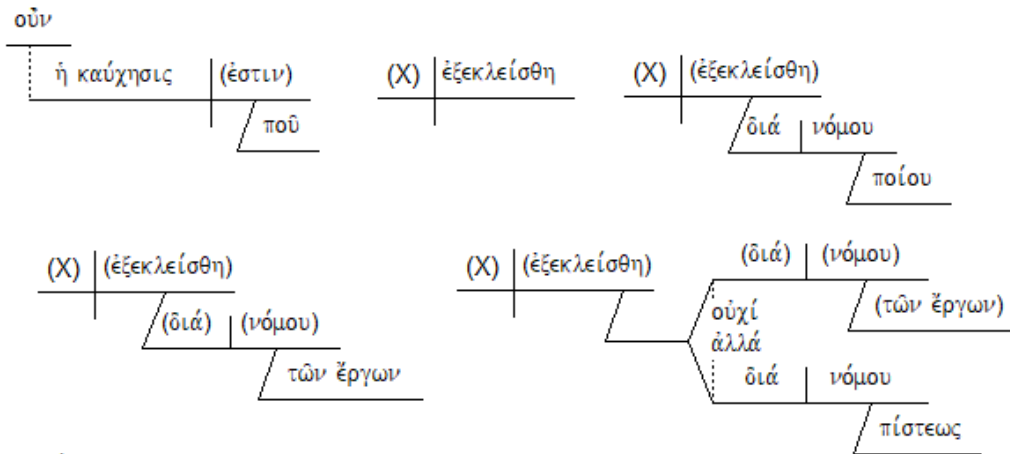

Rom 3:28

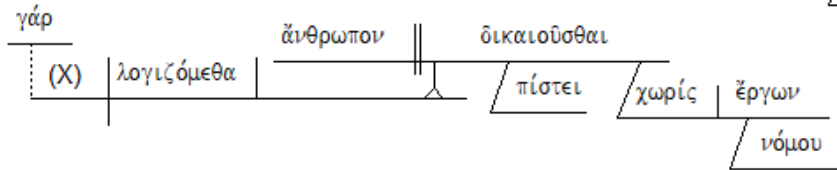

Rom 3:29-30

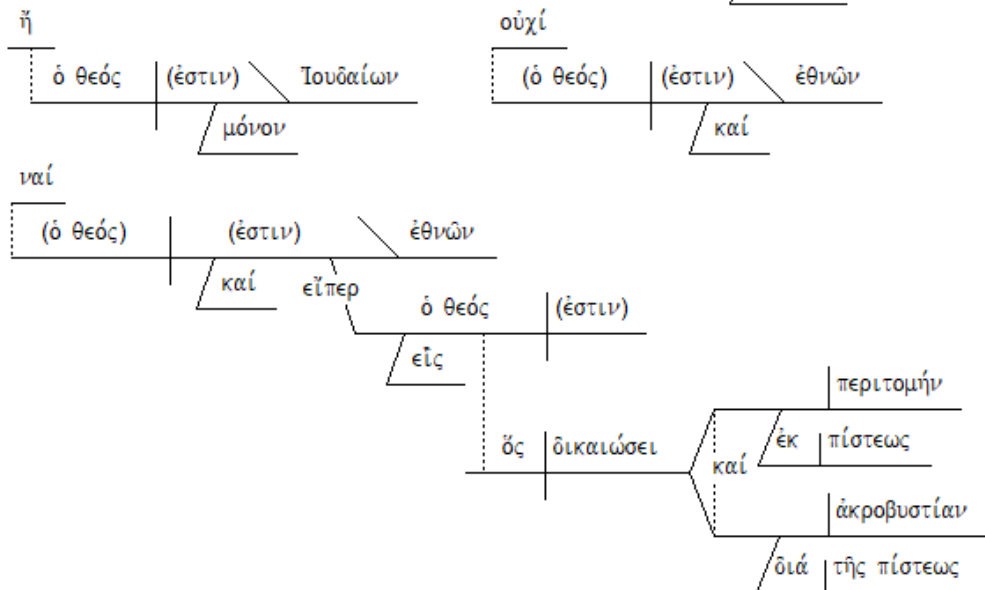

Rom 3:31

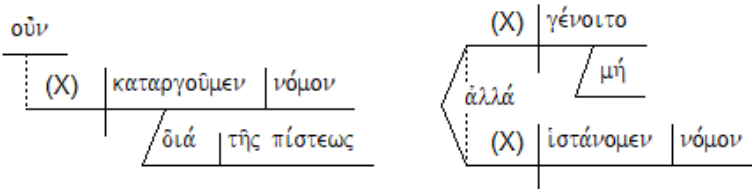

Frank Thielman:

- 21a Contrast But now, **the righteousness of God is disclosed,**
 b Separation apart from the law,
 c Concession although it is attested by the law and the prophets
- 22a Restatement that is, the righteousness of God
 b Means through faith in Jesus Christ
 c Reference to all who believe.
- d Explanation of 22c For **there is no distinction,**
 23a Explanation for **all have sinned and**
 b Explanation **lack the glory of God and**
 24a Explanation are justified
 b Manner freely,
 c Means by his grace,
 d Means through the deliverance
 that is in Christ Jesus,
 whom God displayed publicly
 as the mercy seat,
 through faith,
 by his blood
- 25a Expansion
 b Restatement
 c Means
 d Means
- e Purpose of 25a–d for a proof of his righteousness,
 on account of the dismissal of sins previously committed
 because of the forbearance of God
- f Explanation of 25e
- 26a Explanation
 b Restatement for the proof of his righteousness
 c Time in the present time,
 d Purpose in order that he might be just
 even while justifying the one who has faith in Jesus.
- 27a Rhetorical Question **Where, then, is boasting?**
 b Assertion (Inference) **It has been shut out.**
 c Rhetorical Question **Through what law?**
 d Rhetorical Question **That of works?**
 e Assertion **No, but through the law of faith.**
- 28a Explanation For **we hold that a human being is justified**
 b Manner by faith
 c Manner apart from works of the law.
- 29a Rhetorical Question **Or is God the God of the Jews only?**
 Rhetorical Question **Is he not also God of the gentiles?**
 Assertion (Inference) **Yes, also of the gentiles,**
- 30a Basis since God is one,
 b Contrast/Comparison who will justify the circumcision
 by faith and
 the uncircumcision
 through that same faith.
- 31a Rhetorical Question **Do we cancel the law through this faith?**
 b Exclamation **Certainly not!**
 c Assertion **Rather, we uphold the law.**

TEXT: ROMANS 4:1-17A

TITLE: OT ROOTS TO NT TRUTH – SOLA FIDE

BIG IDEA:

JUSTIFICATION BY FAITH APART FROM WORKS HAS ALWAYS BEEN GOD'S UNIVERSAL PLAN OF SALVATION--THE OT EXAMPLE OF ABRAHAM

INTRODUCTION:

Thomas Schreiner: In **chapter 4** Paul introduces Abraham as an example to confirm the first two themes of **3:27–31**: that righteousness is by faith and not works (**4:1–8** and **3:27–28**) and that all people receive righteousness in the same manner (**4:9–16** and **3:29–30**). Both of these arguments serve to defend the thesis that gentiles can join Jews in the new people of God as the children of Abraham. God always intended that the salvation pledged to Abraham would embrace the entire world, and this point is clarified when one considers the case of Abraham. Thus any notion that the people of God should be confined to the Jews is rejected.

Frank Thielman: Abraham, the forefather of the Jewish people, proves Paul's point that the gospel of justification by faith excludes boasting, whether in one's works or in one's ethnic origins. God counted Abraham righteous not because of his works but because he trusted God to be gracious to him. Moreover, God graciously gave Abraham the blessing of forgiveness as a response to Abraham's faith, not as a response to his circumcision, which occurred after God had already counted Abraham righteous. Abraham, therefore, is the father of all who believe, not merely the father of those who have received physical circumcision. . .

This passage seeks to show that the principle of God's free and gracious forgiveness of sin apart from any human effort is not something newly revealed in the gospel but also sits at the theological center of the Old Testament. Paul has already made his basic point that God justifies people by faith apart from works of the law in **3:21–31**, and now he makes that same point over again but does so out of the Old Testament narrative of God's dealings with Abraham.

Douglas Moo: In **3:27–31**, Paul briefly mentions two implications of the truth that we are justified by faith and not by "*observing the law*" (**v. 28**):

- We cannot boast in our own religious accomplishments (**v. 27**), and
- Jews and Gentiles have equal access to justification (**vv. 29–30**).

In **chapter 4** he develops both these points with reference to Abraham

Thomas Constable: Paul's readers could have understood faith as being a new method of salvation, since he contrasted faith with the Mosaic Law. The apostle began this epistle by saying that the gospel reveals a righteousness from God, implying something new (**1:17**). Was justification by faith a uniquely Christian revelation contrasted with Jewish doctrine? No. In this chapter the apostle showed that God has always justified people by faith alone. In particular, he emphasized that God declared Abraham, the father of the Jewish nation, righteous because of his faith. One of the present values of the Old Testament is that it shows that God justified people by

faith in the past. If Paul could show from the Old Testament that Abraham received justification by faith, he could convince his Jewish readers that there is only one method of salvation (3:29-30).

David Thompson: BEING IN A RIGHT RELATIONSHIP WITH GOD IS BY HAVING THE RIGHTEOUSNESS OF GOD, WHICH COMES BY JUDICIAL CALCULATION AND THAT HAS NEVER BEEN BY RELIGIOUS RITES OR RITUALS, BUT IT HAS ALWAYS BEEN BY FAITH.

1. (:1-5) JUSTIFICATION BY FAITH ALONE IS ROOTED IN THE OT EXAMPLE OF ABRAHAM – ONLY NAKED FAITH LEADS TO RIGHTEOUSNESS SINCE ANY RELIANCE ON HUMAN ACHIEVEMENT MAKES GRACE IMPOSSIBLE

A. (:1) Abraham Makes a Good Proof Case

“What then shall we say that Abraham, our forefather according to the flesh, has found?”

R. Kent Hughes: Paul acknowledges that Abraham was righteous, but he denies that the Jews had any right to present him as an example of righteousness by the works of the Law. Here in **Romans 4** Paul takes Abraham away from the proponents of works-righteousness and brilliantly sets him forth as an example of those who are saved, not by works, but by faith alone—**sola fide**.

Michael Gorman: Abraham, especially as portrayed in this chapter and in **Galatians 3**, is highly significant for any interpretation of justification. What Paul does with Abraham here is quite fascinating.

For Jews in Paul’s day, Abraham filled a variety of roles:

- founder of monotheism who abandoned polytheism/idolatry
- paradigmatic convert to Judaism
- exemplar of virtue, righteousness, fidelity, and meritorious obedience, especially in his offering of Isaac (**Gen 22**, known to Jews today as the Akedah [*“binding”*] but not discussed by Paul here)
- biological father (forefather/ancestor) of all Jews: the first to be circumcised and thus the first member of the covenant people

Ancient Jews embraced Abraham and especially stressed their father’s obedience. Some believed he obeyed the law even before Moses gave it. And clearly some saw him not only as the father of the Jewish people but also as the model proselyte (convert), a former gentile/pagan. A Jewish argument about who and what a Jew actually is (recall **2:28–29**) needs Abraham to be convincing. . .

We can summarize the role of Abraham in **Rom 4** with two words: **proof** and **paradigm**. Abraham is not only the proof but also the paradigm of justifying faith.

B. (:2) Human Achievement Would Leave Room for Boasting

“For if Abraham was justified by works, he has something to boast about; but not before God.”

Grant Osborne: If God could be put in debt to any person, he would not be God. The idea of earning one's salvation is based on the erroneous assumption that people can somehow cause God to owe them something because of something they have done. The picture of a person standing before God and asking to be given "only what I deserve" is wrong in two ways:

- (1) It fails or refuses to recognize the depth of human sinfulness, and
- (2) it displays a disregard for the holiness and majesty of God.

Being given only what we deserve would result in our worst nightmare. Trying to earn God's favor may come from pride or misunderstanding, but it is neither effective nor right.

If Abraham was accepted by God because of what he did, then he would have something to boast about. This was the traditional rationale for religious pride that Paul expects from his Jewish questioner. Many Jews saw Abraham as justified by his works, especially in his obedience to God's command to sacrifice Isaac. They believed that he had every reason to boast in his relationship with God. As Abraham's descendants, they believed that they also had reasons for pride. But Paul knocks down that argument by saying . . .

But not before God. There can be no boasting about anything when it comes to God. The pride of the Jews in their special status before God and in all their laws had made them unable to see that the only way to be justified before God is by humble faith.

C. (:3) The Testimony of the OT Regarding Abraham is Clear

"For what does the Scripture say?"

'And Abraham believed God, and it was reckoned to him as righteousness.'"

John Murray: The condensation of the apostle's expression here is liable to obscure for us his argument. It is to the effect of the following syllogism.

- (1) If a man is justified by works he has ground for glorying.
- (2) Abraham was justified by works.
- (3) Therefore Abraham had ground for glorying.

Paul emphatically challenges and denies the conclusion. He is saying in effect: though the syllogism is formally correct, **it does not apply to Abraham.** How does he disprove the conclusion? By showing that the minor premise is not true. He proves that Abraham was not justified by works and, by proving this, he refutes the conclusion. This is the import of the statement, "*But not toward God*". And how does he disprove the minor premise? Simply by appeal to Scripture; he quotes **Genesis 15:6** which must on all accounts be regarded as the most relevant to the case in hand. **Genesis 15:6** says nothing of works. "*For what saith the Scripture? Abraham believed God and it was reckoned to him for righteousness*" (vs. 3).

Thomas Constable: Exactly what Abraham believed is not clear in **Genesis 15**. The Hebrew conjunction *waw* used with a perfect tense verb, as in **Genesis 15:6**, indicates a break in the action. A good translation is: *Now he [Abram] had believed in the LORD.*" Abraham had obviously believed God previously (cf. **Gen. 12:1- 4, 7; 14:22-24; Heb. 11:8**). However when Abraham was promised that he would receive an heir from his own body, plus innumerable descendants (**Gen. 15:4**), He believed this promise as well. Later, in **Romans 4:13**, Paul revealed that Abraham believed God's promise that "*he would be heir of the world.*" That is, he

believed that God would bless the whole world through him. Exactly what Abraham believed is incidental to Paul's point, which was that he trusted God and, specifically, **believed God's promise**.

David Thompson: Now the **context** of **Genesis 15:6** is crucial to understanding Paul's point.

- 1) Abraham was in the Promised Land (**Genesis 13:14-18**).
- 2) He was somewhere around 85 years old (**Genesis 12:4; 16:16**).
- 3) He had no physical heir even though God had promised him one (**Genesis 15:2a**).
- 4) He thought his slave Eliezer of Damascus would inherit all his promised blessings (**Genesis 15:2b**).
- 5) God came to Abraham and told him that he would father a son and produce a lineage as vast as the stars (**Genesis 15:4-5**).

Now here is the main point - Abraham believed what God told him and God counted or calculated that faith for righteousness (**Genesis 15:6**).

Bob Deffinbaugh: If justification were on the basis of our works we would face several problems.

- First, man would have a basis for boasting. Surely this is wrong for we are created and saved in order to praise and bring glory to God, not to boast concerning ourselves.
- Second, we would then operate under a system of obligation, rather than under grace. Under grace God is free to give us what we do not, in and of ourselves, deserve, while under obligation, God must give us exactly what we deserve—and, who wants that?
- Third, it is contrary to both Old and New Testament Scripture.

D. (:4-5) Application of Accounting Analogy from Employment: Justification is By Grace Through Faith Apart from Works

1. (:4) Grace Cannot Co-Exist with Obligation

“Now to the one who works, his wage is not reckoned as a favor, but as what is due.”

Frank Thielman: An employee's pay is not a gift but the discharge of a financial obligation. With Abraham in Genesis 15:6, however, there is no mention of work, only of reliance on the generosity of God and of God's willingness, surprisingly, to count that reliance as righteousness.

John Murray: God isn't praising laziness here. “The antithesis is not simply between the worker and the non-worker but between the worker and person who does not work but believes.”

2. (:5) Justification Must Be By Faith Alone Apart from Works – God Imputing Righteousness to the Undeserving

“But to the one who does not work, but believes in Him who justifies the ungodly, his faith is reckoned as righteousness,”

John Murray: The description given in **verse 5**, “*him who justifies the ungodly*” is intended to set off the munificence of the gospel of grace. The word “*ungodly*” is a strong one and shows the magnitude and extent of God's grace; his justifying judgment is exercised not simply upon the unrighteous but upon the ungodly. **Verse 5** is a general statement of the method of grace and is

not intended to describe Abraham specifically. We have here, rather, the governing principle of grace; it is exemplified in the case of Abraham because he believed in accordance with that principle.

John Schultz: Ungodliness is the prerequisite for justification. Only the ungodly will be justified. This means that when a person considers himself to be good, or even half-good, he does not qualify for God's justification in Jesus Christ. Salvation is for those who know themselves to be lost. In order to be saved, we have to declare our own bankruptcy. The **Jamieson, Fausset, and Brown Commentary** puts it more bluntly: "The apostle in this verse expresses himself in language the most naked and emphatic, as if to preclude the possibility of either misapprehending or perverting his meaning. The faith, he says, which is counted for righteousness is the faith of 'him who worketh not.' But as if even this would not make it sufficiently evident that God, in justifying the believer, has no respect to any personal merit of his, he explains further what he means, by adding the words, 'but believeth on Him who justifieth the ungodly;' those who have no personal merit on which the eye of God, if it required such, could fasten as a recommendation to His favor. This, says the apostle, is the faith which is counted for righteousness." **Geneva Notes** adds: "That makes him who is wicked in himself to be just in Christ."

II. (:6-8) JUSTIFICATION BY FAITH ALONE IS SUPPORTED BY THE OT TESTIMONY OF DAVID – FORGIVENESS OF SINS BRINGS TRUE HAPPINESS SINCE RIGHTEOUSNESS IS RECKONED APART FROM WORKS

Steven Cole: The greatest blessing of all is to have God forgive all your sins.

A. WE MUST FEEL THE HEAVY BURDEN OF OUR GUILT.

So a guilty conscience is a good thing. It's like the pain sensors in our body, which alert us to a problem. A person with leprosy can't feel pain, and so he can burn his finger off without knowing it. If we suppress our guilt, it often leads to other emotional, physical, and relational problems. But guilt should get our attention by shouting, "You're not right with God!" David suppressed his guilt over his sin with Bathsheba for about a year until the prophet Nathan cornered him with a story and then directly said, "You are the man!" You're guilty!

B. FORGIVENESS IS THE GREATEST OF ALL BLESSINGS.

A. (:6) David Makes for a Good Supporting Witness

"just as David also speaks of the blessing upon the man to whom God reckons righteousness apart from works:"

Frank Thielman: The translation "*happiness*" (cf. REB, TOB [*"bonheur"*]) is an effort to communicate the idea of "inner contentment" that is present in Paul's use of the term but is obscured by the usual translations "*blessed*" and "*blessedness*." The term is rare in the Greek Bible, occurring only here, in **4:9**, and in **Galatians 4:15**. Its use in **Galatians 4:15**, however, is particularly instructive. The wider context of that occurrence shows that we should understand it as the contentment and well-being people feel about their relationships with each other when those relationships are peaceful. That would also be a fair description of what the psalmist felt,

according to **Psalm 32:1–5**, about his relationship with God now that he has confessed his sins and God has forgiven them. Here, then, Paul probably used the term to interpret **Psalm 32:1–2a** as the psalmist’s expression of happiness that God has counted him righteous despite his sin and apart from any good works, and so his relationship with God is now peaceful.

B. (:7-8) True Happiness Depends on Removing the Shame and Guilt of Sin

1. (:7a) Forgiveness of Sins

“Blessed are those whose lawless deeds have been forgiven,”

- Sin is Inevitable
- Works are Inadequate

2. (:7b) Covering of Sins

“And whose sins have been covered.”

3. (:8) Removal of Accountability for Sin

“Blessed is the man whose sin the Lord will not take into account.”

Thomas Schreiner: To be counted as righteous apart from works is to have one’s lawless deeds forgiven, one’s sins covered, and one’s sin not taken into account. The close relationship between justification and forgiveness supports the forensic and relational meaning of righteousness.

R. Kent Hughes: Paul calls David blessed, and David twice calls himself “blessed” because when there was no work that could possibly atone for his sins he was forgiven on **sola fide!** So the principle of faith alone was mightily established and illustrated in the life of Israel’s greatest king—a “*man after [God’s] own heart*” (**I Samuel 13:14**). Nothing you and I can ever do can atone for our sins. Our only hope is “*the righteousness of God [that] has been manifested apart from the law, although the Law and the Prophets bear witness to it—the righteousness of God through faith in Jesus Christ for all who believe*” (**Romans 3:21, 22**).

III. (:9-12) JUSTIFICATION CANNOT DEPEND ON RELIGIOUS RITES (CIRCUMCISION) OR ETHNIC IDENTITY (JEWS) SINCE FAITH IS GOD’S UNIVERSAL PLAN DOWN THROUGH THE AGES

Michael Gorman: (**4:9–15**) establishes Abraham’s justification prior to his circumcision (**vv. 9–12**) and apart from the law of Moses (**vv. 13–15**). Abraham’s circumcision is narrated in **Gen 17:9–14**, which is obviously an event that **postdates** his justification by faith recounted in **Gen 15:6**. Circumcision, then, was not a prerequisite for Abraham’s justification but a sequel to it, serving as a seal (**4:10–11**). The implication, of course, is that still in Paul’s day, circumcision is not necessary for the blessings of forgiveness, justification, and membership in God’s family (cf. **3:30**), and, in fact, circumcision is insufficient to make one a descendant of Abraham. He is the “*ancestor*” (lit. “*father*”) of the uncircumcised who believe (**4:11b**) and of the circumcised who believe in the way Abraham did before his circumcision (**4:12a**).

A. (:9-10) Circumcision Not Essential for Justification

1. (:9) Justification by Faith Applies to All Apart from Circumcision

“Is this blessing then upon the circumcised, or upon the uncircumcised also? For we say, ‘Faith was reckoned to Abraham as righteousness.’”

Grant Osborne: Ceremonies and rituals serve as reminders of our faith, and they instruct new and younger believers. But we should not think that they give us any special merit before God. They are outward signs and seals that demonstrate inward belief and trust. The focus of our faith should be on Christ and his saving actions, not on our own actions.

2. (:10) Circumcision Not a Factor in Abraham’s Justification

“How then was it reckoned? While he was circumcised, or uncircumcised? Not while circumcised, but while uncircumcised;”

Frank Thielman: The biblical story of Abraham describes his justification by faith (**Gen 15:6**) well before his circumcision (**Gen 17:24**), and so Abraham’s circumcision could have played no role in his justification. God justified Abraham by faith as a gentile, not as a Jew, and this makes the literal rite of circumcision or one’s membership in the Jewish people irrelevant to the question of one’s standing with God (cf. **1 Cor 7:18–20; Gal 5:6; 6:15**).

B. (:11-12) Circumcision Still Significant in the Case of Abraham

1. (:11a) Relation of Circumcision to Abraham’s Faith:

a. A Sign

“and he received the sign of circumcision,”

b. A Seal

“a seal of the righteousness of the faith which he had while uncircumcised,”

John Murray: At **verse 11** Paul does define for us, however, **the relation of circumcision to Abraham’s faith**. Although circumcision contributed in no way to the exercise of faith nor to the justification through faith, for the simple reason that it did not yet exist, yet circumcision did sustain a relationship to faith. Circumcision, he insists, was not a purely secular rite nor merely a mark of racial identity. The meaning it possessed was one related to faith. Paul did not make the capital mistake of thinking that, because it had no efficiency in creating faith or the blessedness attendant upon faith, it had therefore no religious significance or value. Its significance, he shows, was derived from its relation to faith and the righteousness of faith. *“And he [Abraham] received the sign of circumcision, a seal of the righteousness of the faith which he had in uncircumcision” (vs. 11)*. In a word, it signified and sealed his faith. . .

It is usual to discover a distinction between a **sign** and a **seal**; a sign points to the existence of that which it signifies, whereas a seal authenticates, confirms, and guarantees the genuineness of that which is signified. This distinction was no doubt intended by the apostle. The seal is more than definitive of that in which the sign consisted; it adds the thought of authentication. And the seal is that which God himself appended to assure Abraham that the faith he exercised in God’s promise was accepted by God to the end of fulfilling to Abraham the promise which he believed.

Bob Deffinbaugh: The mere presence of an inspection sticker on your car does not make that car road-worthy, but it does represent in a visible fashion its road-worthiness. On the other hand, putting an inspection sticker on a car with bald tires, a faulty muffler, and no brakes will be of little help in hazardous driving conditions. Circumcision was a seal which attested to the faith of Abraham. It signified that he was righteous in the eyes of God.

Steven Cole: What then is the benefit of religious “rituals,” such as baptism and communion? Should we do them at all? Yes, because Scripture commands us to do them. But they should only be done *after* you have put your trust in Christ as your righteousness. They then become a sign pointing to that reality and a seal that attests to your faith in Christ.

2. (:11b-12) Relation of Abraham to All True Believers

a. (:11b) Father of True Uncircumcised Believers

“that he might be the father of all who believe without being circumcised, that righteousness might be reckoned to them,”

David Guzik: “*Our father Abraham*” is an important phrase, one that the ancient Jews jealously guarded. They did not allow a circumcised Gentile convert to Judaism refer to Abraham as “our father” in the synagogue. A Gentile convert had to call Abraham “your father” and only natural born Jews could call Abraham “our father.” Paul throws out that distinction, and says that through faith, all can say, “*our father Abraham.*”

b. (:12) Father of True Circumcised Believers

“and the father of circumcision to those who not only are of the circumcision, but who also follow in the steps of the faith of our father Abraham which he had while uncircumcised.”

IV. (:13-17a) JUSTIFICATION CANNOT DEPEND ON OBEDIENCE TO LAW SINCE GOD OPERATES VIA GRACIOUS PROMISES

A. (:13) Principle: God’s Gracious Promises Are Appropriated by Faith Not by Obedience to the Law

“For the promise to Abraham or to his descendants that he would be heir of the world was not through the Law, but through the righteousness of faith.”

B. (:14) Disconnect between Obedience to Law and Faith in God’s Promise

“For if those who are of the Law are heirs, faith is made void and the promise is nullified;”

C. (:15) Purpose of the Law

“for the Law brings about wrath, but where there is no law, neither is there violation.”

R. Kent Hughes: the Law promotes transgression and wrath (cf. **5:20; 6:7, 8**). No one can keep the Law; so the Law enhances one’s sense of transgression and failure and the sense of being under God’s wrath. The Law promotes defeat and pessimism, but faith brings joy, assurance of

the promise, and thus a life of optimism.

“Don’t be fooled,” says Paul in effect, “the principle of faith transcends the Law.” Abraham was counted as righteous because of his faith. So was David. **Sola fide** preceded the Jews; it preceded the Law; it is for everyone!

D. (:16-17) Only Faith Is Consistent with Grace and Brings Assurance of Promise

“For this reason it is by faith, that it might be in accordance with grace, in order that the promise may be certain to all the descendants, not only to those who are of the Law, but also to those who are of the faith of Abraham, who is the father of us all, 17 (as it is written, ‘A father of many nations have I made you’)”

David Guzik: To speak technically, we are not saved by faith. We are saved by God’s grace, and grace is appropriated by faith.

Spurgeon: Grace and faith are congruous, and will draw together in the same chariot, but grace and merit are contrary the one to the other and pull opposite ways, and therefore God has not chosen to yoke them together.

DEVOTIONAL QUESTIONS:

- 1) What contribution does this passage make to the argument regarding infant baptism vs. believer baptism?
- 2) What are some specific promises of God that you are currently believing?
- 3) What are some of the ways that we wrongly try to manipulate God or put Him under obligation?
- 4) Are we living out our Christian faith under the principle of works or of grace?

QUOTES FOR REFLECTION:

S. Lewis Johnson: So the apostle in the 4th chapter is expounding the **one way of salvation**, Old Testament or New Testament, **men are saved on the principle of grace through the instrumentality of faith**. Now this is something that the apostle has alluded to twice already. He has said in the **2nd verse** of the 1st chapter concerning the gospel, that it was promised before hand by his prophets in the Holy Scriptures, and then in chapter 3 **verse 21**, he says, "*Now the righteousness of God apart from the law is manifested, being witnessed by the law and the prophets.*" So if you had come to Paul and you had said to Paul, "Paul, is the doctrine you are proclaiming different from the doctrine that we have been told down through the centuries?" He

would have said, "Absolutely not, what I am saying to you is witnessed by the law and the prophets and the gospel of God is that which is promised beforehand by his prophets in the Holy Scriptures. I am just expounding to you the same message that God has been teaching down through the centuries."

Frank Thielman: Abraham Was Justified neither by His Works nor by His Circumcision but by Faith (4:1–12)

1. Abraham Was Counted Righteous by Faith rather than by Works and Therefore Had No Ground for Boasting (4:1–8)
 - a. **Genesis 15:6** proves Paul's point (4:1–3)
 - b. What **Genesis 15:6** means in accounting terms (4:4–5)
 - c. The same principle from a different text, **Psalm 32:1–2** (4:6–8)
2. Abraham Was Counted Righteous by Faith before He Was Circumcised and Therefore Had No Ground for Boasting in His Identity as a Jew (4:9–12)

Douglas Moo: The focus is especially on the nature and meaning of Abraham's believing. Another way to look at the chapter, then, is in terms of a series of antitheses by which Paul unfolds the significance of Abraham's faith—and of ours:

1. Faith is something completely different from "works" (vv. 3–8).
2. Faith does not depend on any religious ceremony (e.g., circumcision) (vv. 9–12).
3. Faith is not related to the law (vv. 13–17).
4. Faith often rests in a promise that flies in the face of what is natural and normal (vv. 18–22).

David Thompson: Abraham is a tremendous illustration to every Jew that religious rituals and circumcision will not save them. Circumcision gives Abraham a relationship with all Jews. Faith gives Abraham the righteousness that relates him to God.

There is only one way to have God credit a person with the righteousness that will save them. It is by faith in Jesus Christ. Faith in Jesus Christ is God's gospel that will save you.

This is not about your religious rites or rituals. This is not about your circumcision. This is not about your baptism. This is not about your catechism. This is not about your confirmation. This is not about your religious law-keeping or religious traditions of men or a denomination.

There is only one way to get God to legally take care of the sin debt we have and that is by faith in Jesus Christ. He has paid the full price. Believe in Jesus Christ and you will be saved.

F. Godet: Abraham being for the Jews the embodiment of salvation, his case was of capital moment in the solution of the question here treated. This was a conviction which Paul shared with his adversaries. Was the patriarch justified, by faith and by faith alone, his thesis was proved. Was he justified by some work of his own added to his faith, there was an end of Paul's doctrine. In the first part of this chapter, **Ro 4:1-12**, he proves that Abraham owed his righteousness to his faith, and to his faith alone. In the second **Ro 4:13-16**, he supports his argument by the fact that the inheritance of the world, promised to the patriarch and his posterity, was conferred on him independently of his observance of the law.

Leedy Greek NT Diagrams:

Rom 4:1

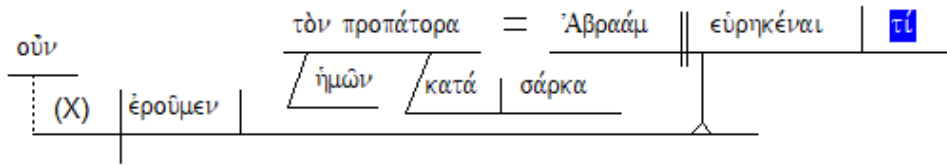

Rom 4:2

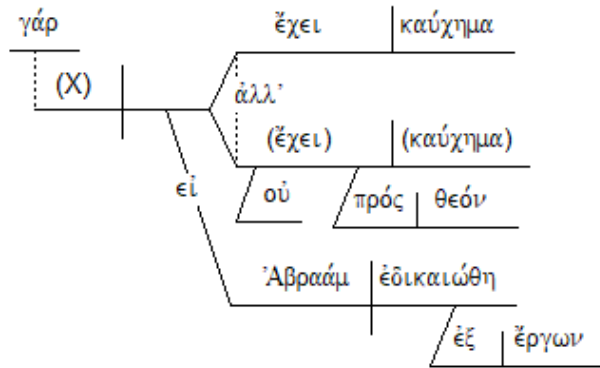

Rom 4:3

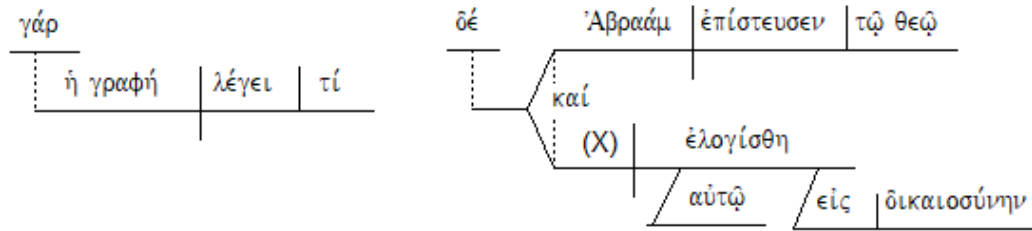

Rom 4:4-8

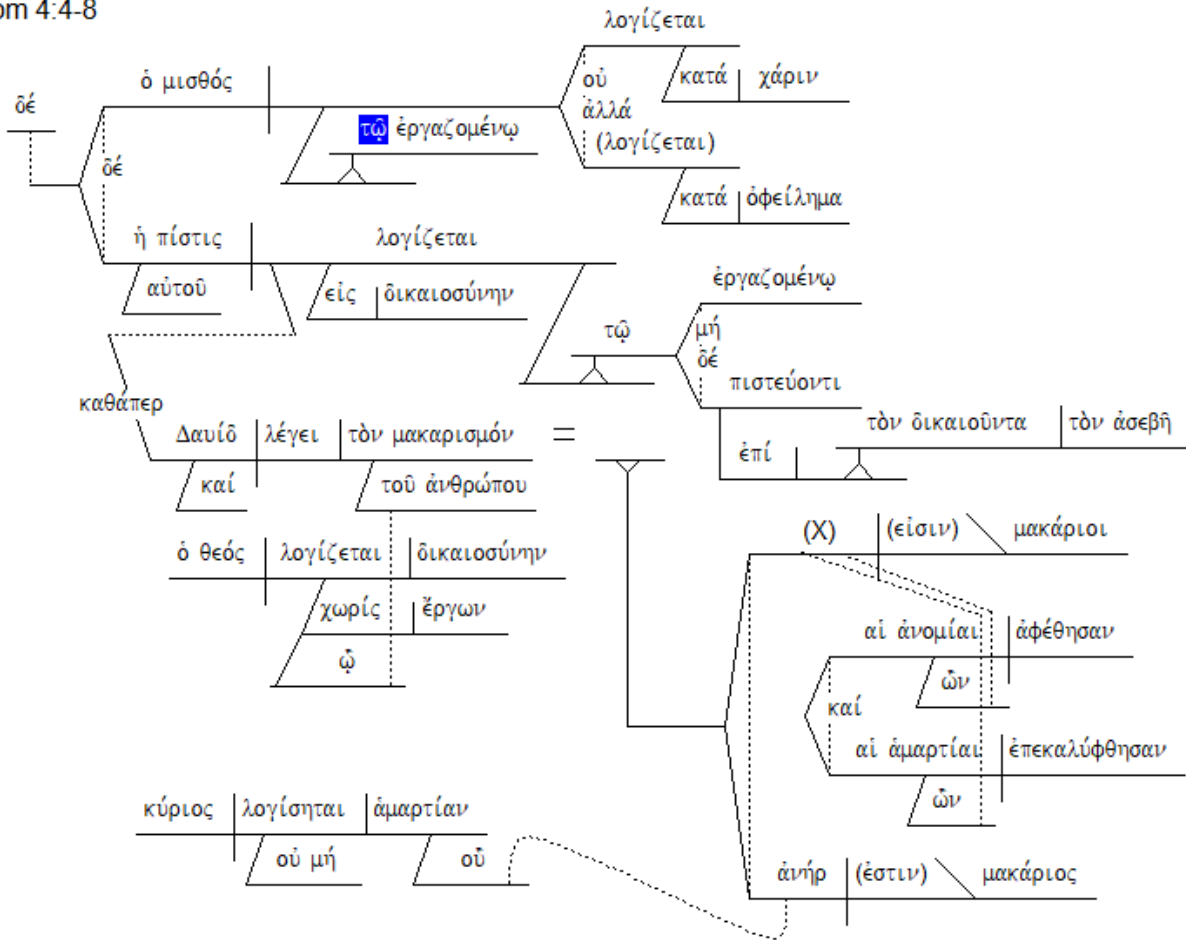

Rom 4:9

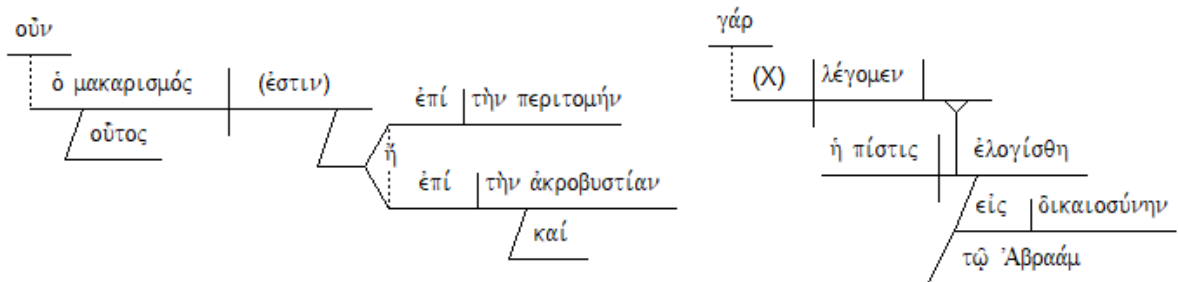

Rom 4:10-12

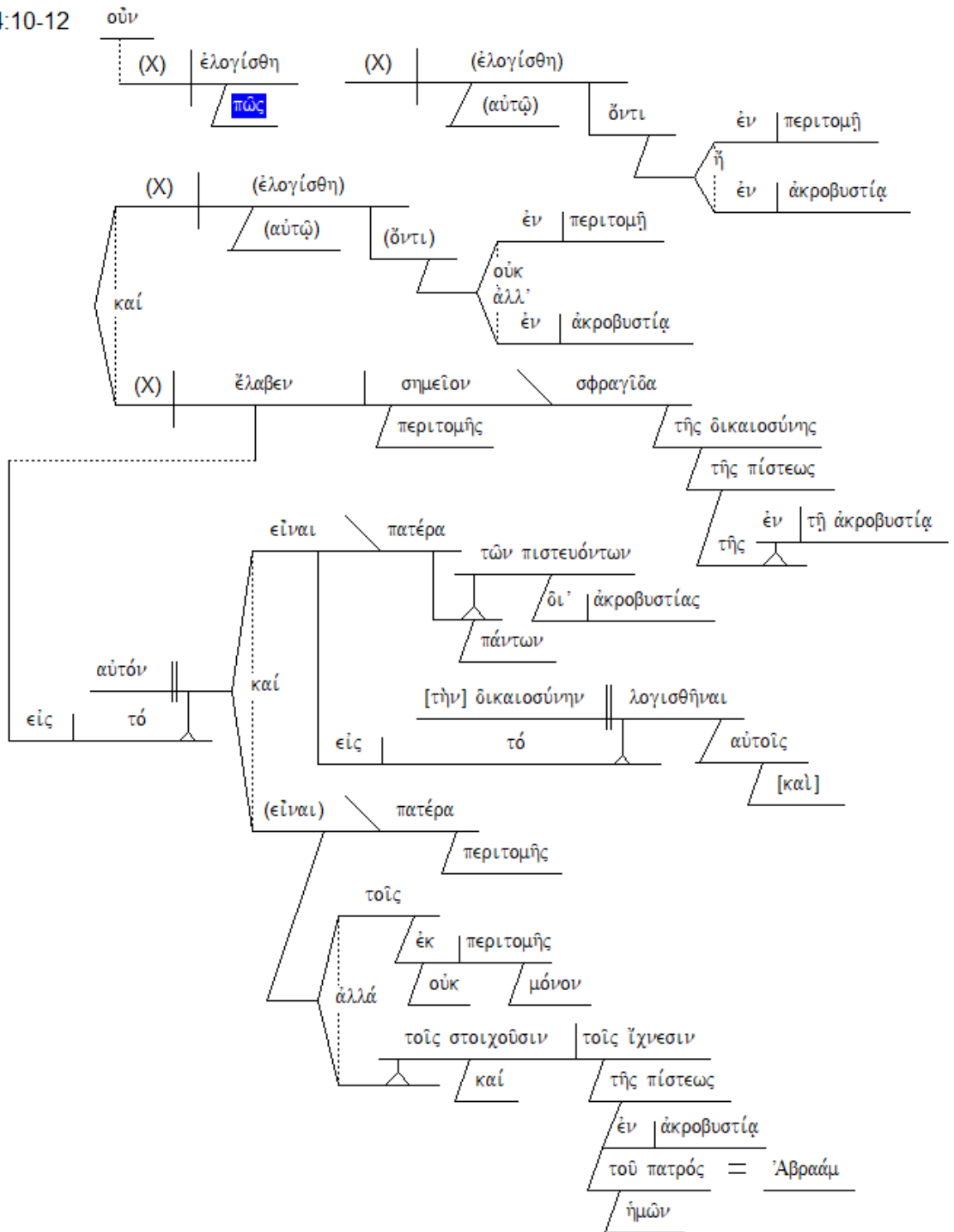

Rom 4:13

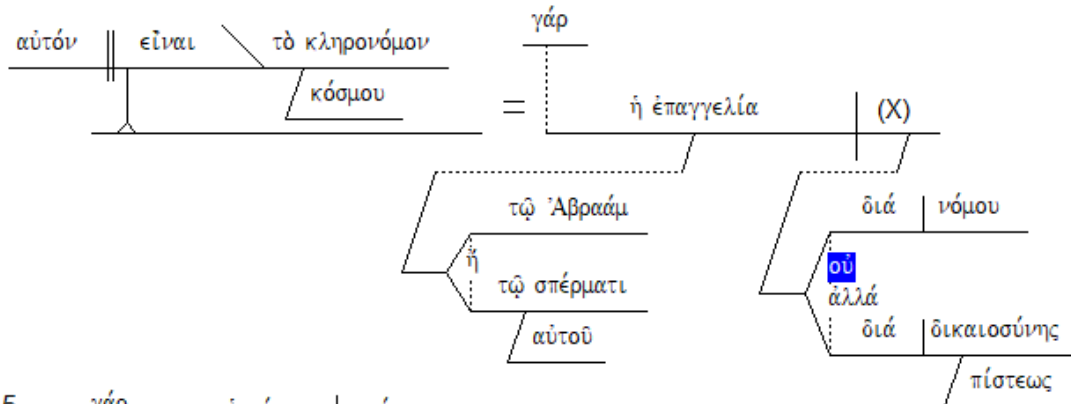

Rom 4:14-15

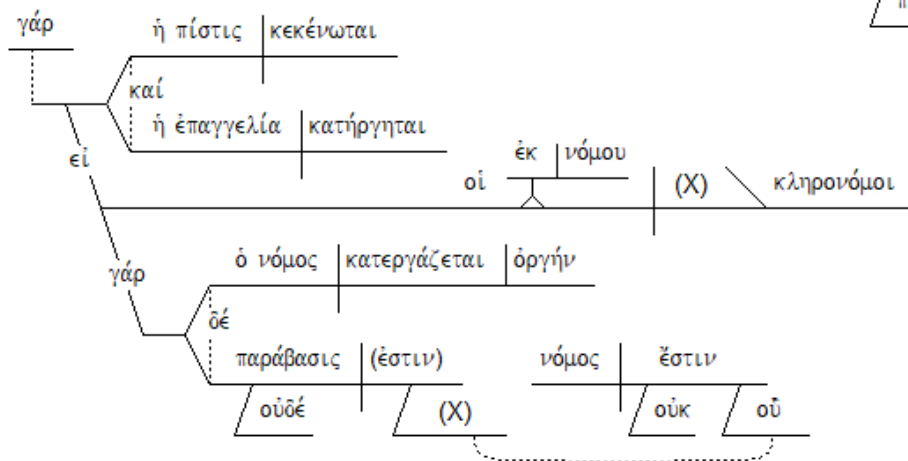

Rom 4:16-21

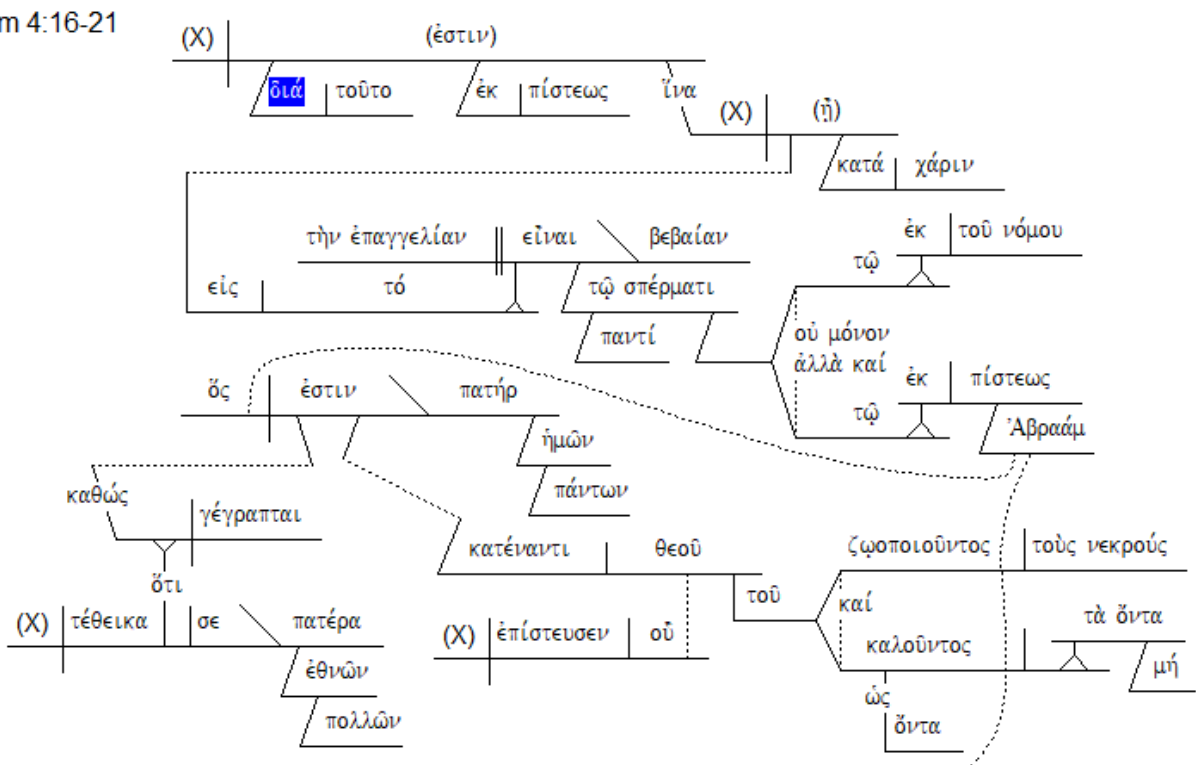

Frank Thielman:

1a Rhetorical Question	What, then, shall we say that Abraham,
b Apposition	our forefather according to the flesh, found to be the case?
2a Explanation	For
Condition	if Abraham was justified by works,
b Inference	he has a reason for boasting—but
c Contrast	not with God.
3a Rhetorical Question	For what does the Scripture say?
Verification (of 2c)	
b Cause	"But Abraham believed God, and
c Result	it was counted to him as righteousness." (Gen 15:6)
4 Illustration	Now wages are not counted as a favor to the one who works but
Contrast/Comparison	as a debt;
5a Explanation	but
b Contrast/Comparison	to the one who does not work but
	believes on him who justifies the impious,
c Assertion	his faith is counted as righteousness.
6 Verification (of 4–5)	Just as David describes the happiness of the human being for whom God counts righteousness apart from works
7a Assertion	"Happy are those
b Restatement	whose lawless acts are forgiven and
	whose sins are covered.
8 Restatement (of 7a–b)	Happy is the person
	whose sin the Lord will not count." (Ps 32:1–2a)
9a Rhetorical Question	Is this happiness for the circumcision or also
b General	for the uncircumcision?
c Explanation	For we say faith was counted
d	to Abraham
e	as righteousness.
10a Restatement (of 9a)	How, then, was it counted?
Specific	
b More specific	When he was circumcised or when he was uncircumcised?
c Exclamation	Not when he was circumcised but when he was uncircumcised!
11a Explanation	And he received the sign of circumcision
Manner	as a seal of the righteousness
Means	by faith
Identification	that he had in his uncircumcised state,
b Purpose	in order that he might be
c Circumstances	the father of all who believe
d Result	while uncircumcised, so that righteousness might be counted to them, and
12a Parallel	the father of the circumcised
b Advantage	for those who are not only from the circumcised but also
	follow
	in the footsteps
	of the faith of our father Abraham,
c Description	faith that he had in his uncircumcised state.

<p>13a Basis (of 11b–12c)</p> <p>Content of 13a</p> <p>Contrast</p>	<p>For it was not through the law that the promise came</p> <p style="margin-left: 100px;">to Abraham or to his offspring</p> <p style="margin-left: 100px;">that he would be heir of the world, but</p> <p style="margin-left: 100px;">through the righteousness of faith.</p>
<p>14a Explanation (of 13)</p> <p>Condition</p> <p>b Inference</p>	<p>For if the people of the law are heirs,</p> <p>faith is rendered useless and the promise invalidated.</p>
<p>15a Explanation (of 14b)</p> <p>b Expansion (of 15a)</p>	<p>For the law produces wrath (indeed where there is no law, neither is there transgression).</p>
<p>16a Result (of 13–15a)</p> <p>b Assertion</p> <p>c Purpose (of 16a)</p> <p>d Purpose (of 16b)</p> <p>e Description</p> <p>f Expansion (of 16d)</p> <p>g Description</p>	<p>Because of this,</p> <p>it is by faith,</p> <p>so that it might come as a gift,</p> <p>in order that the promise might be confirmed</p> <p style="margin-left: 100px;">to all his offspring, not only to those of the law but also to those of the faith of Abraham,</p> <p style="margin-left: 100px;">who is the father of us all.</p>
<p>17a Verification (of 16f)</p> <p>b Place (of 17a)</p>	<p>Just as it is written, "I have made you the father of many nations" (Gen 17:5)</p> <p style="margin-left: 100px;">—in the sight of God.</p>

TEXT: ROMANS 4:17B-25

TITLE: REAL FAITH: OT EXAMPLE AND NT APPLICATION

BIG IDEA:

RECEIVING GOD'S PROMISED BLESSING HAS ALWAYS REQUIRED REAL FAITH—THE KIND OF FAITH THAT LOOKS BEYOND NATURAL OBSTACLES TO FIND ASSURANCE IN GOD'S POWER AND FAITHFULNESS

INTRODUCTION:

Frank Thielman: Paul, then, describes Abraham's faith in God's willingness and ability to bring life to the dead despite the human improbability that this could happen (4:18–22). Paul and the Roman Christians similarly trust that God raised from the dead the same Lord Jesus who died for their trespasses. This faith provides the context in which God accounts them righteous, just as he did with Abraham (4:23–25).

A. Berkeley Mickelson: In this section the reader sees the God in whom Abraham believed. He also learns what obstacles and difficulties Abraham overcame because of his firm trust. Both Abraham and the Christian share the same conviction: God gives life to the dead.

Warren Wiersbe: These verses are an expansion of one phrase in **Romans 4:17**: "*who quickeneth the dead.*" Paul saw the rejuvenation of Abraham's body as a picture of resurrection from the dead, and then he related it to the resurrection of Christ.

One reason why God delayed in sending Abraham and Sarah a son was to permit all their natural strength to decline and then disappear. It was unthinkable that a man ninety-nine years old could beget a child in the womb of his wife who was eighty-nine years old! From a reproductive point of view, both of them were dead.

But Abraham did not walk by sight; he walked by faith. What God promises, He performs. All we need do is believe.

Charles Hodge: The object of this section is the illustration of the faith of Abraham, and the application of his case to our instruction.

- With regard to Abraham's faith, the apostle states, first, its **object**, viz. the divine promise, **vers. 18**.
- He then illustrates its **strength**, by a reference to the apparent impossibility of the thing promised, **vers. 19, 20**.
- The **ground** of Abraham's confidence was the power and veracity of God, **ver. 21**.
- The consequence was, that he was justified by his faith, **ver. 22**.
- Hence it is to be inferred that this is the true method of justification; for the record was made to teach us this truth. We are situated as Abraham was; we are called upon to believe in the Almighty God, who, by raising up Christ from the dead, has accepted him as the propitiation for our sins, **vers. 23-25**.

I. (:17b) REAL FAITH MAKES SENSE BECAUSE OF WHO GOD IS = HIS POWER AND FAITHFULNESS

“in the sight of Him whom he believed,”

Frank Thielman: The words translated here “*in the sight of God, whom he believed*” (κατέναντι οὗ ἐπίστευσεν θεοῦ) are difficult and have been understood to mean “*in light of which [promise] he believed*” or “*in the presence of the God whom he believed.*” The proper translation hangs on the meaning one gives to the preposition (κατέναντι), whether “*in the sight of,*” “*in light of,*” or “*in the presence of.*” It also depends on the antecedent one chooses for the relative pronoun (οὗ), whether the promise of **Genesis 17:5** in the previous clause or “*God*” in the following clause. It is very difficult to find a use of the preposition with the meaning “*in light of,*” and the attraction of an antecedent (θεοῦ) into the case of the relative pronoun (οὗ) is reasonably common in Greek. The most obvious reading of the phrase, then, according to the standard meaning of the terms and the rules of Greek grammar is that in the sight of God Abraham was the father of many nations, Jews as well as gentiles.

The God in whose sight Abraham was the father of believers from many people groups (**4:16c–17a**), and the God in whom Abraham believed (**4:17c**), is the God who makes the dead alive. The broader context of this statement shows that Paul was thinking both of God giving life to Abraham and Sarah’s “dead” child-bearing abilities (**4:19c–e**) and of God raising Jesus from the dead (**4:24–25**). Without both these life-giving miracles, God’s promise to Abraham would have remained unfulfilled.

John Murray: The clauses which follow . . . are descriptive of the aspects of God’s character which are peculiarly appropriate to the faith exercised; they point to those attributes of God which are the specific bases of Abraham’s faith or, at least, to the attributes which were in the forefront of Abraham’s apprehension when he believed the promises and put his trust in the Lord.

A. He is the God of Resurrection Power

“even God, who gives life to the dead”

Thomas Schreiner: Abraham believed in the God who could infuse life where there was none by his resurrecting power. The bodies of Sarah and Abraham, which were dead in terms of childbearing, were renewed so that they could beget and conceive a child in fulfillment of God’s promise.

James Stifler: Old Testament faith rests on **resurrection**. Acceptable faith is not merely the conviction that there is a God and that He is benevolent and a just rewarder of the good and evil; this is the world’s faith. Abraham’s was more; he became the father of many nations by believing in God as one “*who quickeneth the dead.*” He not only believed in God’s existence and that he could bless; this is not sufficient; he believed that that blessing could only come from God as now active in nature for spiritual ends – a spiritual creator just as once he was a creator of nature. Faith gets its character from that character in which it accepts God. Abraham looked on

Him as one who in spite of nature is **making alive the dead**. This is the leading thought in this section. God calls the things that are not, not in the possibilities of nature, as if they already were; He calls them into existence.

B. He is the God of Sovereign Faithfulness

“and calls into being that which does not exist.”

Frank Thielman: Paul, then, describes God as one whose purposes and promises are so certain to happen that God speaks of them as if they already exist. This understanding of the phrase fits neatly into the context of **Genesis 17:5** where God names Abraham the “*father of a multitude*” when he and Sarah remain childless, and also speaks definitively in the **perfect tense** of having made (τέθεικα) Abraham the father of many nations.

John Murray: These things do not yet exist, but since determined by God they are “*called*” by him as having existence. The certainty of their futurity is just as secure as if they had come to pass. And the word “*call*” is used of God’s effectual word and determination. The promises given to Abraham were in that category; the things promised had not yet come into being, they were non-existent as respects realization. But, because God had promised them and therefore determined that they should come to pass, the certainty of their realization was secure. . . . God’s promise was for Abraham as good as fulfilment. The things that were not yet did not belong to the category of the possible but to that of determinate certainty, and Abraham possessed the promises in God (cf. **Heb. 11:1**).

Application to Us Today:

- God’s character has not changed
- God’s power has not waned

II. (:18-19) REAL FAITH LOOKS BEYOND NATURAL OBSTACLES

A. (:18) God’s Promise Seemed Unattainable

“In hope against hope he believed, in order that he might become a father of many nations, according to that which had been spoken, ”So shall your descendants be.”

Frank Thielman: Abraham could not reasonably hope for children from the human perspective, but he nevertheless based his faith on a hope that was grounded in the character of the God Paul has just described—the God who gives life to the dead and speaks of his future plans as if they have already happened.

Michael Gorman: Faith, therefore, is **forward-looking**—centered on resurrection and new creation—and therefore virtually synonymous with **hope**: “*Hoping against hope, he [Abraham] believed*” (**4:18a**), meaning he demonstrated unwavering trust and fidelity. Hope, then, is future-oriented, even eschatological (focused on the age to come)—but also focused on the realization of God’s promises in this age, especially the promise of life out of death. Such was Abraham’s focus.

Alva McClain: “*believed against hope*” – That looks like a contradiction. But it means simply that there was no human ground for any hope, but he believed God anyway, and his faith gave him a hope. That is the way we do today. Sometimes when things are going wrong, if we can just believe God, then we have hope. Out of our faith comes hope.

B. (:19) Natural Obstacles Seemed Insurmountable

1. Abraham’s Old Age

“And without becoming weak in faith he contemplated his own body, now as good as dead since he was about a hundred years old,”

2. Deadness of Sarah’s Womb

“and the deadness of Sarah’s womb;”

Michael Gorman: In **4:19–22**, Paul describes the bleak situation in which Abraham and Sarah found themselves: **a state of death**. English translations often fail to convey the severe stench of death arising from Paul’s words. Abraham did not consider his body to be “*as good as dead*” (NRSV, NIV, CEB); it was, to him, literally “*already dead*” (**4:19** MJG). Furthermore, he recognized the “*deadness*” (NET; cf. NIV, CEB) of Sarah’s womb; Paul uses a Greek word indicating the condition of a corpse (*nekrōsis*), obviously a much stronger image than simply “*barrenness*” (NRSV). For Jews of Paul’s day, a barren womb and the lack of children were a living death. Abraham and Sarah **needed a resurrection from the dead**.

Application to Us Today:

- How unattainable do God’s promises seem to us today?
- What are the obstacles facing us today = a test of our faith?

III. (:20-21) REAL FAITH FINDS ASSURANCE IN GOD’S POWER AND FAITHFULNESS

A. (:20a) Confident Faith Does Not Waver But Strengthens

*“yet, with respect to the promise of God,
he did not waver in unbelief,
but grew strong in faith,”*

Frank Thielman: In the face of his difficult physical circumstances Abraham responded with a divinely strengthened faith and trusted God’s word. This, it turns out, was an act of worship—the sort of worship that God desires. . . . Abraham’s trust in God’s promise, against all humanly conceived odds, was the appropriate act of worship for someone whose relationship with God was what it should be.

Grant Osborne: **Wavering** is vacillating between choices, fluctuating in our resolve, and faltering in our commitment. Here are some warnings for the wavering:

- Do you waver in your opinion?
Seek counsel from God’s Word.
- Do you falter in your allegiance?
Place your will under God’s control.

- Do you hesitate in your decision making?
Trust God and follow him.

Strengthened in his faith. When we act upon trust, it becomes stronger. **Exercised faith** develops persistence. As Abraham encountered obstacles, his faith saw him through, and his confidence in God grew. When we meet and overcome opposition, we **strengthen our spiritual muscles**. Victories over temptation urge us on to new resolutions. Faced with the facts that would lead Abraham to doubt, he still maintained his trust. He may have hesitated or questioned his own ability, but he maintained his trust in God. When God's promises conflict with the hard facts, our stronger faith will enable us to obey him.

B. (:20b) Confident Faith Focuses on Giving Glory to God
“giving glory to God,”

Thomas Schreiner: Here the **God-centered character of faith** emerges again. The secret of Abraham's faith is that he acknowledged **God's glory** (here his power; cf. also **6:4**) by trusting God's ability to carry out his promises as the resurrecting and sovereign God. We have seen that the fundamental sin of human beings is the failure to give glory to God (**Rom. 1:21–23**), the worship of the creature rather than the Creator (**1:25**; cf. **Byrne** 1996: 154–55). By contrast, faith glorifies God because it acknowledges that life must be lived in complete dependence on him (**Nygren** 1949: 182; **Keck** 2005: 130). The supreme way to worship God is not to work for him (**4:4–5**) but to trust that he will fulfill his promises. As **Schlatter** (1995: 116) says, “To disavow the credibility of God is to refuse him the honor that the individual owes him.”

John Murray: “*Giving glory to God*” and “*being fully persuaded that what he has promised he is able also to perform*” are coordinate and describe the exercises or states of mind which were involved in Abraham's faith. To give glory to God is to reckon God to be what he is and rely upon his power and faithfulness. To be fully persuaded denotes the full assurance and efflorescence of conviction (cf. **14:5**; **Col. 4:12**). The object of this conviction is stated to be “*that what he [God] has promised he is able also to perform*”. Both causes in coordination mark a fullness of expression indicative of the strength and vigour of Abraham's faith.

C. (:21) Confident Faith Expects God to Deliver on His Promises
“and being fully assured that what He had promised, He was able also to perform.”

Frank Thielman: Here Paul refers to Abraham being completely filled with the conviction that God was powerful enough to make Abraham the father of many nations despite his human limitations (cf. **14:5**). The idea of **completeness** and **integrity** contained in the term forms a neat contrast with the divided mind pictured in **4:20**.

Application to Us Today:

- What type of attacks threaten to weaken our faith?
- How is our faith strengthened?

IV. (:22-25) REAL FAITH WILL ALWAYS RECEIVE GOD'S PROMISED BLESSING

A. (:22) Connection Between Faith and Justification

“Therefore also it was reckoned to him as righteousness.”

Frank Thielman: The repetition of this climactic statement from **Genesis 15:6** brings Paul's description of Abraham's justification by faith full circle. He has now carefully defined what he means by faith. It is reliance on God's promise that he is able to bring life to the dead, despite appearances to the contrary. Faith of this quality brings glory to God, and God graciously puts it down in the heavenly books as righteousness. Although this faith is not a work, it is nevertheless the right approach to God. God accepts it and withholds his wrath from all whose lives are characterized by it.

Douglas Moo: What Paul is claiming is that Abraham, overall, maintained a firm conviction in God's promise and acted on it. He had his momentary doubts, it is true, but they were momentary and always overcome by his faith in the God who had promised. By doing so, Abraham glorified God, because he took him at his word (**4:20b–21**). This is why, Paul concludes, *“it [faith] was credited to him as righteousness.”* Here, at the end of Paul's exposition of Abraham's faith and its consequences, he cites again the key verse with which he began (**Gen. 15:6**; cf. **Rom. 4:3**).

B. (:23-24) Connection between Abraham's Justification and Future Believers

“Now not for his sake only was it written, that it was reckoned to him, 24 but for our sake also, to whom it will be reckoned, as those who believe in Him who raised Jesus our Lord from the dead,”

Frank Thielman: Paul says in this section that the description of the **object** and **quality** of Abraham's faith in the scriptural narrative provides instruction to believers in the present about the object and quality of their faith in God.

Thomas Schreiner: The application of Abraham's experience to the Romans doesn't constitute an unreflective transfer of an OT text to Christian believers. In this chapter Paul has labored to show that the OT itself anticipated that Abraham would function as the father of many peoples, and he has explained that the universal blessing promised to Abraham involves the inclusion of the gentiles. Thus that his life would become the exemplar for future generations is hardly surprising. We would expect that Abraham's children would be counted righteous in the same way that he was counted righteous. This explains why the nature of Abraham's faith is depicted for us in **verses 17–21**. . .

Although the continuity between Abraham and Christian believers is emphasized, we should not overlook the implicit discontinuity. Nowhere does Paul say that Abraham believed in the resurrection of Jesus. The element of continuity is that both Abraham and Christians believed in the God who resurrects the dead and in a God who fulfills his promises. For Christians such faith necessarily involves belief in the resurrection of Jesus in history, while Abraham could not have such a specific faith because he lived before the time of fulfillment.

C. (:25) Christ's Death and Resurrection = the Key to the Gospel

1. Significance of Sacrificial Death of Christ

"He who was delivered up because of our transgressions,"

Douglas Moo: In **verse 25**, Paul adds a description of this Jesus whom God raised from the dead. The description falls into two parallel lines:

<i>Who</i>	<i>was delivered over to death</i>	<i>for our sins</i>
<i>And</i>	<i>was raised to life</i>	<i>for our justification</i>

In the first line of this confession, the preposition "*for*" (Gk. *dia* followed by accusative) probably means "*because of*." In the second line, however, it is difficult to give the same word this meaning. For Christ's resurrection was not based on, or caused by, our justification. Probably, then, the word "*for*" in the second line has the sense "*in order to accomplish*." The parallelism between the two lines is rhetorical and does not extend to the meaning of the word.

[Alternate interpretation has the advantage of treating the two uses of *dia* as parallel:]

Everett Harrison: So "*delivered over to death for our sins*" can mean "*because our sins were committed*" and it was on account of them that Jesus had to die if salvation were to be procured. Similarly, "*raised to life for our justification*" can mean that Jesus was resurrected because our justification was accomplished in his death (cf. "*justified by his blood*," **5:9**).

2. Significance of Powerful Resurrection of Christ

"and was raised because of our justification."

Steven Cole: Perhaps the simplest way to understand it is that Jesus was delivered up to death as a consequence ("*because*") of our sin; He was raised as a consequence ("*because*") of our justification, which He achieved by His death (**Rom. 5:9**). In other words, when God raised Jesus, He put His seal of approval on Christ's death as obtaining our justification (**Murray J. Harris**, *The New International Dictionary of New Testament Theology*, ed. by Colin Brown [Zondervan], 3:1184). So the resurrection confirms that our justification was valid and acceptable to the Father.

Michael Bird: In this verse there are strong echoes of **Isaiah 53:5, 11-12**, where Jesus appears as the Suffering Servant who was handed over to death, bore the sins of many, was vindicated by seeing the light of life, and resultantly makes many righteous. Importantly, the main verbs are **divine passives**, so that Jesus was handed over *by God* (*paredothē*) and raised up *by God* (*ēgerthē*), which indicates we are dealing with a theocentric act of God in the cross and resurrection. Furthermore, the two prepositional phrases, though both beginning with the preposition *dia*, are inexact in their parallelism. The first phrase is **retrospective** in that Jesus was delivered over to death *because of* our transgressions (*dia ta paraptōmata hēmōn*), while the second phrase is **prospective** in that Jesus was raised up to life *for the purpose of securing* our justification (*dia tēn dikaiōsin hēmōn*). Taken together, Jesus' death has dealt with sins, while Jesus' resurrection establishes the justification of believers.

The link between resurrection and justification has struck some commentators as odd. While Paul often ties justification to the cross and blood of Christ (see **Rom 3:24-25; 5:9**), he can also put salvation in relation to Jesus' resurrection (see **1 Cor 15:17**). We must remember that the resurrection constitutes Jesus' own justification since the resurrection is God's cosmic verdict that Jesus is the Messiah, Lord, and Son of God (see **Acts 2:36; Rom 1:3-4; 1 Tim 3:16**). So, on the cross Jesus undergoes our condemnation for sin (**Rom 8:1**), and in his resurrection he becomes the source of our justification (**1 Cor 1:30**). The death and resurrection of Jesus Christ is an apocalyptic event within which the justification of believers takes place. Thus, by a Spirit-forming faith, we have union with Christ, and what is true of him becomes true of us. In other words, we are justified because our transgressions have been forgiven at the cross and because we are incorporated into the justification of Jesus the Messiah in his resurrection.

Frank Thielman: Bruce A. Lowe, in an important article on **Romans 4:25**, has provided the most likely explanation of the **link between Christ's resurrection and the believer's justification**. **Lowe** ties the sentence closely to what Paul has just said about Abraham's faith in the God "*who makes the dead alive*" (**4:17-22**). The context of Abraham's justifying faith was a situation in which, against all human hope, Abraham trusted that God could enliven his and Sarah's ability to bear a child so that Abraham would become the father of many nations. In the same way, Paul and the Roman Christians have placed their trust, against all human hope, in the gospel's affirmation that God raised Christ from the dead and in the further conviction that Christ's resurrection is the first instance of the general resurrection of believers from the dead (**8:11, 18-25**; cf. **1 Cor 15:12-20; 2 Cor 4:13-14**). The resurrection of Christ, then, provided the basis for the justification of believers because it gave a concrete, if unseen, object for their hope and for their trust in God. Christ's resurrection provided an opportunity analogous to the opportunity that God gave to Abraham in **Genesis 15:1-6** for his people to put their faith in him and for him to count this trust as righteousness.

Application to Us Today:

- In what ways do you see yourself as following in the footsteps of OT saints like Abraham?
- How can we keep our faith focused on the implications for us of Christ's death and resurrection?

* * * * *

DEVOTIONAL QUESTIONS:

- 1) Why can we be confident that God will fulfil His promises to us?
- 2) What support do you find in the OT that God's people believed in resurrection power and in God's ability to bring life from death?
- 3) What are some of the qualities of authentic faith from this passage?
- 4) In what sense or degree are the obstacles to your faith not as seemingly insurmountable as those faced by Abraham and Sarah?

* * * * *

QUOTES FOR REFLECTION:

Thomas Schreiner: Establishing a **paragraph division** here is debatable, since **verse 17** continues the sentence begun in **verse 16**, and the *καθώς* (*kathōs, just as*) clause introduces a Scripture citation supporting Abraham’s universal fatherhood. **Verse 16** closes by affirming that Abraham is the father of all, and the citation of **Gen. 17:5**—“*I have appointed you as the father of many nations*”—provides evidence that Abraham’s fatherhood over all nations was God’s intention from the beginning. Moreover, the theme of **Abraham’s paternity** continues in the following verses. It is specifically mentioned in **verse 18**, and God’s promise regarding his descendants is the object of his faith in **verses 19–21**.

Despite these observations, a **shift in emphasis** is also discernible in these verses. Paul doesn’t lose sight of Abraham’s universal fatherhood, but the paragraph as a whole stresses the **nature of Abraham’s faith**. Paul glides, almost imperceptibly—even in the middle of the sentence in **verse 17**—from the fatherhood of Abraham to the kind of faith that made Abraham a suitable father. Paul highlights Abraham’s fatherhood because universal blessing is promised to the world through Abraham, but he also explores the **quality and nature of Abraham’s faith**. If Abraham by his faith functions as the father of all peoples, and if his faith was counted to him as righteousness, then it is imperative to define the nature of his faith. This is crucial because one cannot be a child of Abraham and have righteousness counted to oneself (cf. **vv. 23–24**) without possessing the faith of Abraham.

Schnabel (2015: 499–500) -- **Ten qualities of authentic faith in this text:**

- (1) Authentic faith trusts in God’s righteousness, not in mere human wishes and hopes, such as healing from diseases.
- (2) Authentic faith trusts in God’s sovereign and creative power, which raised Jesus from the dead.
- (3) Authentic faith trusts in God’s promise instead of human calculation.
- (4) Authentic faith puts its hope in God’s promise.
- (5) Authentic faith doesn’t concentrate on human weakness.
- (6) Authentic faith is realistic and doesn’t overlook human incapacity.
- (7) Authentic faith doesn’t doubt God’s reliability and promise.
- (8) Authentic faith grows strong through God.
- (9) Authentic faith gives glory to God, who raises the dead and gives life where there is none.
- (10) Authentic faith acknowledges God as sovereign, as the Almighty One who brings salvation.

R. Kent Hughes: The Faith of Abraham

I. Abraham’s Perception of the Object of Faith (v. 17)

The object of Abraham’s faith is very easy to discern. It was God alone, according to **verse 17**. . .

Abraham grasped two massive concepts about God. First, he understood that God “*gives life to the dead*.” Although there had been no recorded resurrection at this point in history, and although God had not revealed any doctrine of resurrection, **Abraham believed in God’s resurrection**

power! This was borne out when he obediently raised the knife above Isaac. He knew that if Isaac died, God could resurrect him (cf. **Genesis 22:5; Hebrews 11:19**).

Second, he saw God as a God who “*calls into existence the things that do not exist.*” God creates *ex nihilo*, from nothing. This is, of course, a towering concept. Perhaps, in retrospect, there is some suggestion here of God’s restoration of Abraham and Sarah’s procreation process. God for all intents and purposes created Isaac *ex nihilo*.

Abraham’s perception of God as the object of his faith was immense, and this gigantic concept dominated his entire experience of faith. It can make all the difference in us too. . .

II. Abraham’s Perception of the Obstacles to Faith (vv. 18–20)

Abraham’s faith faced two obstacles. The obvious barrier to his believing God would give him a child was the biological impossibility due to Sarah’s and his age.

The less obvious obstacle was the staggering nature of the promise. That is, the promise was so wonderful, it was hard to believe—it was too good to be true!

Some people are under the impression that when a person has “faith” he inwardly agrees to ignore the facts. They see faith and facts as mutually exclusive. Faith without reason is fideism; reason without faith is rationalism. In practice there must be no reduction of faith to reason. Likewise, there must be no reduction of reason to faith. Biblical faith is a composite of the two. Abraham did not take an unreasonable leap of faith. . .

Applying this to ourselves, if God is who he says he is (and he is!), none of his promises will fail because he forgets us or our situation is beyond his power. The problem is, many of us keep in the back of our minds unexercised suspicions that what we say we believe about God’s power is not really true. For all our lip service about trust in God, we rely chiefly upon what we can do ourselves. Some of us need to take deeper possession of the truths we have already believed about God. A good measure of how much spiritual truth we have appropriated is, how long is our worry list?

III. Abraham’s Perception of the Objectives of Faith (vv. 20b–22)

The first objective of his faith was **to glorify God**, as the last line of **verse 20** asserts: “. . . *but he grew strong in his faith as he gave glory to God.*” In this connection we should emphasize that God is never glorified in a believer’s life apart from faith—a full reliance on God. Abraham’s life glorified God as few lives have because he demonstrated a faith that few mortals have shown. Some argue convincingly that **verse 21** is one of the best **definitions of faith** in the Bible as it describes Abraham as “*fully convinced that God was able to do what he had promised.*” May we glorify God in the same way, taking him at his word.

The second objective of Abraham’s faith was **righteousness**. **Verse 22** concludes the description of Abraham’s faith by saying, “[*it*] was counted to him as righteousness.” Faith that makes one righteous before God perceives the immensity of God who creates from nothing and gives life to the dead (**v. 17**). Next, it is a faith that does not deny the existence of obstacles, but evaluates them in the light of God’s Word and power (**vv. 18–20**). Ultimately, it brings the full assurance

that what God has promised, he will perform (v. 21). That faith is reckoned for righteousness (v. 22). Faith is the only way any of us will ever be righteous before God.

Michael Gorman: Ultimately, then, Abraham bears witness not only to the nature of faith as trust, hope, and fidelity but also to the nature of justification—receiving both the forgiving mercy of God and the new, resurrection life of God. That is, the means of justification is faith, but the meaning (content) of justification includes resurrection from the dead (cf. 6:4) as well as forgiveness—and (as we saw in 3:21–26) even more. Abraham has a kind of proto-Christian faith; he is the **prototype of justification as resurrection to new life**, a topic Paul will discuss at length in **chapter 6**, in connection with baptism as participation in Christ’s death and resurrection. Even in 5:18, however, he will summarize justification as consisting of life.

What Abraham found (NRSV, “*gained*,” 4:1), then, was in essence the reality revealed in the gospel Paul proclaimed: grace, faith, justification, and life apart from circumcision and law. These are the gifts of the God of grace and life who forgives sins, raises the dead, and creates new life. Without ever denying Abraham’s Jewishness, **Paul universalizes him**. That is why the justified are defined as those who “*share the faith of Abraham*” (4:16). But Paul claims that this universalizing is not original to him: according to Genesis, he reminds us, the covenant with Abraham was for him to be the “*father of many nations*” (4:17, from **Gen 17:1–8**). Paul sees that covenant faithfully fulfilled in the taking of the gospel to the nations, which he articulates in **Rom 10** and practices in his own ministry (see 15:14-33).

Grant Osborne: Are You Fully or Partly Convinced?

With the world seemingly packed with new idols and pagan ideologies, believers find themselves more and more in Abraham’s place. So we must remember the character of this God whom we trust. And we should ask ourselves, “At what points in my life are my convictions about God’s power and faithfulness being put to the test?” Our trust in God will be demonstrated in these and other areas:

- Knowing that God’s forgiveness is complete
- Believing that life extends beyond this one, in heaven or hell
- Being convinced that our life has significance
- Believing that our individual acts of service are meaningful
- Being confident that our needs will never exhaust God’s love
- Knowing that our future is safe in God’s protection
- Trusting that God will watch over our loved ones

Steven Cole: Paul has spent an entire chapter hammering home the truth that we are justified by faith in Christ alone, not by our good works, not by our religious rituals, and not by keeping the Law of Moses. He uses Abraham as the prime example of a man who believed God and it was credited to him as righteousness (4:3, 5, 9, 22). But now, as he wraps up this chapter, he wants us to plug it in personally. He doesn’t want us to cheer and say, “Brilliant argument, Paul! You really stuck it to those religious Jews! Nice going!” No, he wants each of us to apply it on the most fundamental level so that we, too, are sure that the righteousness of Jesus Christ has been credited to our account by faith. In applying this to us, Paul gives us a simple description of what a true Christian is:

A Christian personally believes in God who delivered over Jesus to pay for our sins and raised Him from the dead to confirm our justification.

Leedy Greek NT Diagrams:

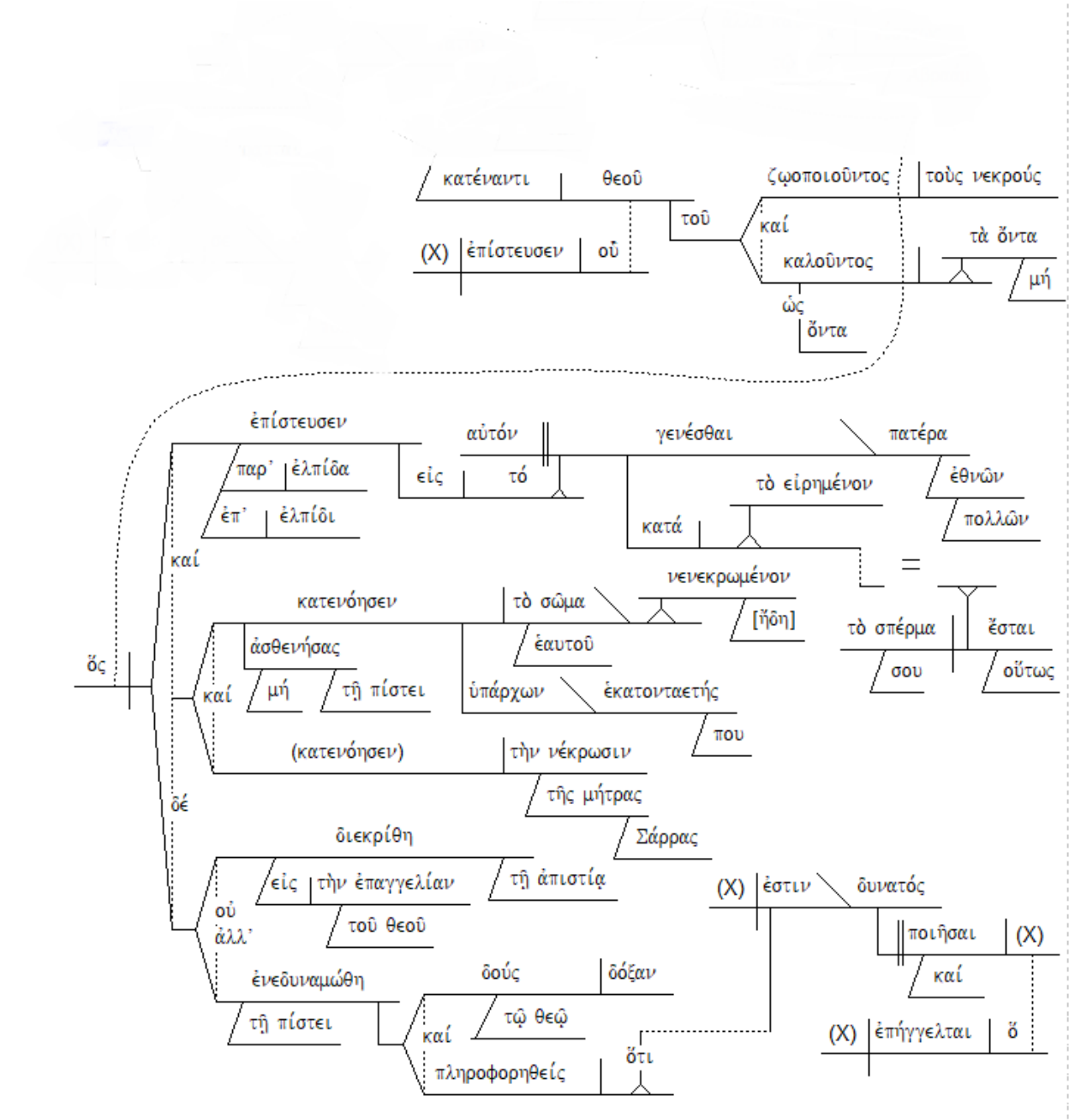

Rom 4:22

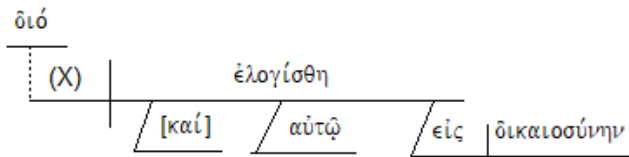

Rom 4:23-25

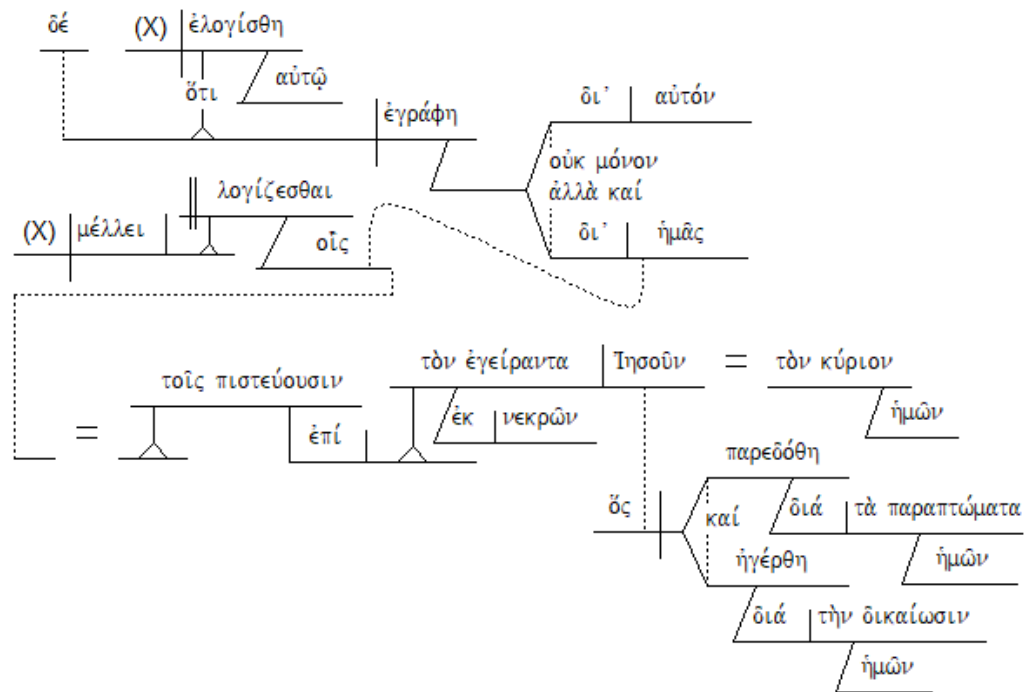

Frank Thielman:



TEXT: ROMANS 5:1-5

TITLE: CONFIDENT CHRISTIAN LIVING IN LIGHT OF FUTURE GLORY

BIG IDEA:

JUSTIFICATION BY FAITH IS THE FOUNTAINHEAD FOR CONFIDENT CHRISTIAN LIVING IN LIGHT OF FUTURE GLORY – FRUITS OF JUSTIFICATION BY FAITH

INTRODUCTION:

Context: Assuring us that justification by faith is sufficient to carry us through eternity; it will never let us down.

(the foundation of our salvation will bear the weight of our lives)

John Murray: In **verses 1–11** the apostle exhibits the privileges which emanate from justification and belong to the justified. We cannot escape the notes of **assurance** and **exultation**. . .

Thomas Schreiner: Three consequences of righteousness are articulated: **peace, access to grace, and hope**. The last receives the greatest attention in the text (**vv. 2b–5**), validating the contention that hope is the central motif in the text. Paul argues that hope is strengthened even in afflictions, since a chain of effects occurs when troubles strike: troubles beget endurance, endurance produces tested character, and the result of tested character is hope. Contrary to hopes in this world, this hope will not bring shame on the day of judgment because the experience of God's love in the present through the Holy Spirit demonstrates infallibly that believers will not experience God's wrath on the last day.

Frank Thielman: The paragraph [**1-11**] describes lives that are the mirror image of the wicked and impious people in **1:18 – 2:27**. The people described there failed to worship and glorify God as their creator (**1:18–23, 25, 28**) and produced suffering within the world by their violence toward each other (**1:29–32**). They also boasted in God but did not obey him (**2:17**). In contrast, God has transformed the believers whom Paul describes here from God's impious enemies into friends who stand in his grace (**5:1**), experience his love (**5:5**), and boast in what God is doing and will do for them (**5:2–3, 11**). Unlike the people of **1:18 – 2:27** who experience the outpouring of God's wrath now (**1:18**) and will experience it in the future (**2:5, 8**), God has changed the believers of **5:1–11** so that they are at peace with him (**5:1, 10–11**) and have assurance of salvation from his wrath in the future (**5:9**). . .

In this paragraph, Paul makes two affirmations about the lives of those who have been justified by faith.

- First, he says that the love of God provides a firm foundation for the hope of believers that they will share in God's glory. God's love for them is clear from the presence of the Holy Spirit in their lives and from the sacrificial, atoning, and therefore justifying death of Christ.
- Second, Paul affirms that even in the present, with its inevitable experiences of suffering,

believers can live in joyful confidence that God has reconciled them to himself. Although they were once his enemies, they are now at peace with him. He loves them, and they do not, and will not, fall under the wrath that he justifiably pours out on the wicked.

R. Kent Hughes: This passage is remarkable for several reasons. With its exalted language, it is hymn-like. There is also its air of confidence. Paul does not argue his case as he did in the preceding chapters. He simply states the facts in a marvelous chain of confident assertions. Our passage is also personal, as Paul switches to the first person plural—this is his experience along with all true believers. Lastly, the passage is remarkable because the joy of these verses is contagious. Every Christian can deepen his or her optimism and capacity for joy by understanding the benefits of justification as they are given by Paul in **Romans 5:1–11**.

Michael Gorman: In these verses, then, Paul speaks briefly of a unified experience of the Spirit, suffering, love, and hope that he will develop in **chapter 8**. He says that Christians can and should “*boast*” (some translations say “*rejoice*” or “*celebrate*”). They should do so both in their hope of divine glory (**5:2**)—the fullness of God’s presence and conformity to Christ’s resurrected body—and in their sufferings (**5:3**). This is Paul’s redirecting of pride, or honor, away from the self (**3:27–28; 4:2**) and onto God. It is based ultimately in the story of Christ, whose own suffering led to glory, and in whose sufferings and glory Christians are graced to participate (see **8:17**).

S. Lewis Johnson: Now we look at it now and the apostle says, first of all, the believer is safe, and he can be sure of it because of the tribulations of God. He says, “*Therefore, being justified by faith, we have peace with God.*” That’s with reference to the past. Our past, having been covered by the blood of Christ, is now a past that is over for us. We have peace with God. Not only that, he says, but “*We have access by faith into this grace in which we stand.*” That’s something that has to do with the present. We’re able to approach this God and bring our petitions to him, for the way has been opened by our mediator, the Lord Jesus Christ, and in him, we are able to approach the God of this universe. Furthermore, Paul says, “*We rejoice in hope of the glory of God.*” We can look forward to the future, and expect that we should ultimately experience, not only the approval or the affirmation of God, but really the glory of God itself. So the whole key to this, right here in the opening section, is the relationship that we have to the **Lord Jesus Christ**. Through him we have **peace**.

I. (:1) WE HAVE PEACE WITH GOD = RECONCILIATION = A HEALED RELATIONSHIP

*“Therefore having been justified by faith,
we have peace with God through our Lord Jesus Christ,”*

- objective peace
- present possession
- a settled reality
- God has ceased His hostilities against us!

John Toews: Paul establishes the inauguration of “*being made righteous*” as a past fact. Righteousness here, as elsewhere in Romans, is clearly a relational term, defined by peace, access, and reconciliation. The opening participle could be translated as **having been established in right relationship with God.**

John Murray: At the beginning of this chapter we have the intimations of climactic and triumphant conclusion. The “*therefore*” indicates that an inference is being drawn from the doctrine that had been unfolded and demonstrated in the preceding chapters (3:21 – 4:25). . .

“*Peace with God*” denotes relationship to God. It is not the composure and tranquillity of our minds and hearts; it is the status of peace flowing from the reconciliation (vss. 10, 11) and reflects primarily upon God’s alienation from us and our instatement in his favour. Peace of heart and mind proceeds from “*peace with God*” and is the reflection in our consciousness of the relation established by justification. But it is the **objective relation** that is in view here when Paul speaks of “*peace with God*”. It is “*through our Lord Jesus Christ*” that we have this peace.

Frank Thielman: Exactly how the resurrection of Christ contributes to peace with God does not come out explicitly here, but in 8:34 Paul will say that since Jesus has been resurrected and exalted to God’s right hand Jesus continues to intercede on behalf of believers and so they need never fear condemnation.

Grant Osborne: Paul’s readers were intimately acquainted with the *Pax Romana* (Roman Peace), enforced by the power of Rome. It represented about as much security as the world could offer. While living under this uneasy peace, Jesus had told his disciples, “*Peace I leave with you; my peace I give you. I do not give to you as the world gives. Do not let your hearts be troubled and do not be afraid*” (John 14:27 NIV). Peace with God is only possible through Christ, because on the cross he met the conditions required for peace. Not only was “*the punishment that brought us peace*” (Isaiah 53:5 NIV) borne by him, but he also fully lived up to his given title, **Prince of Peace** (Isaiah 9:6). (See also Ephesians 2:14; Colossians 1:20.)

Michael Gorman: The *pax Romana*, like most imperial versions of peace, was the consequence of oppression and death. Rome’s peace and God’s peace are **antithetical realities**, as we will see more fully in 5:6–8. In fact, Rome had made *Pax*, along with *Iustitia* and *Fides* (justice and fidelity), as well as other Roman values, into deities in what is called the “cult of the virtues.” Paul would tell us that such deities are idols; the true God effects peace and justice through absorbing violence, not inflicting it. The true God desires fidelity to a savior who conquers only by love.

Steven Cole: The full title, “*our Lord Jesus Christ*,” looks at all that He is for us. First, He is *our Lord*, which focuses on His deity and His sovereign authority. We are His subjects or slaves. When you become a Christian, there is no option to believe in Jesus as your Savior, but to wait before you submit to Him as your Lord. He is both Savior and Lord, which means that you begin the Christian life by submitting all of yourself that you are aware of to all of Christ that you know. As you grow in Him, you learn more of who He is and what He commands and you see more areas in your life that you need to submit to Him, including your thought life. Jesus is the only rightful Lord of everything.

As *Jesus*, He is fully human. He took on human flesh in the incarnation, yet apart from sin. He lived in perfect dependence on the Father, in perfect obedience to His will. He went to the cross to atone for our sins (**Rom. 3:24-26**).

As *Christ*, Jesus is God's Anointed One, the promised Messiah ("*Christ*" is Greek and "*Messiah*" is Hebrew for "*Anointed One*"). As such, Jesus is God's appointed prophet, priest, and king. As God's anointed prophet, Jesus spoke the very words of God to us (**John 8:16-17**). As God's high priest, Jesus offered Himself once for all to atone for our sins. Now He lives to make intercession for us (**Heb. 7:24-28**). As God's anointed king, Jesus is the rightful Sovereign over our lives. He is coming again to rule the nations with a rod of iron and to tread the winepress of the fierce wrath of God, the Almighty (**Rev. 19:15**).

This means that the only way to have peace with God is through faith in the **Lord Jesus Christ**. There is no other way of salvation (**Acts 4:12**).

II. (:2a) WE HAVE ACCESS TO GOD'S GRACE THROUGH CHRIST'S MEDIATION

"through whom also we have obtained our introduction by faith into this grace in which we stand;"

Significance of perfect tenses

Illustration: victim of AIDS has no hope, nowhere to turn for help

Illustration: curtain in the temple torn -- **Matt.27:51**

R. Kent Hughes: Equally at the root of joy is the *grace* of God. Reading **verses 1 and 2** together makes this very clear. "*Therefore, since we have been justified by faith, we have peace with God through our Lord Jesus Christ. Through him we have also obtained access by faith into this grace in which we stand.*" Grace is God's riches to us. Grace is the unsought, undeserved, and unconditional love of God. Grace is God pursuing us until he has found us and persevering with us ever afterwards. For Paul, grace and peace always go together. Even Paul's greeting in the opening verses of Romans shows this: "*Grace to you and peace . . .*" (**1:7**). To stand in grace is to stand also in peace.

The effect of grace and peace together is to produce an exultant approach to life.

John Murray: A question arises as to the precise import of the word "*access*". Does it mean **introduction** or **access**? If the former, then the accent falls upon the action of Christ as mediator in bringing us nigh to God and instating us in this grace. If the latter, then the accent falls upon **our approach to God in drawing nigh**. Paul's use of this same term elsewhere (**Eph. 2:18; 3:12**) favours the latter interpretation and in that event the privilege afforded believers of free access to God is placed in the foreground. Hence, while the mediation of Christ in the bestowment of justification is the leading thought of the verse, yet in connection with this grace

of justification the particular emphasis falls upon the fact that **the free access or approach to God, which the grace of justification imparts, is itself mediated through Christ**. Even in our drawing nigh to God with confidence we are dependent upon Christ’s mediation—it is through him that we have come to have access and this access is an abiding privilege resultant upon the action which justification involves. The element of acceptance with God, as an implicate of justification, is no doubt in the forefront, since that aspect of justification is particularly appropriate to the thought of access.

Thomas Schreiner: What is this *grace* in which believers stand? Some identify it as **justification** (Murray 1959: 160; Cranfield 1975: 259), and others as the **realm of grace** (Dunn 1988a: 248; Conzelmann, TDNT 9:395; D. Moo 1991: 309). Probably the latter is in view, since the word “*justification*” isn’t used. In any case, Paul wants to assure believers that they will stand in the final judgment, since they are now in the realm of grace (Rom. 14:4; 1 Cor. 10:12; so Wilckens 1978: 289–90).

Frank Thielman: The term “*access*” (προσαγωγή) occurs only here and twice in Ephesians (2:18; 3:12) in biblical Greek, but it is a fairly common term outside the Bible. It could describe the “*access*” that ships might gain to a city through its good harbor (Polybius, Histories 10.1.6) or the “*access*” that the friends of a great ruler might provide for others to their powerful friend (Xenophon, Cyr. 7.5.45). Since Paul has just spoken of Jesus as Lord and that title seems to be especially connected with his resurrection, he was probably thinking of access that believers have to God’s favor because of his continued intercession for them at God’s right hand (8:34). In addition, the term “*grace*” with the demonstrative pronoun (τὴν χάριν ταύτην) points back to the completely free nature of the justification and redemption that came through Jesus’s death (3:24). The perfect-tense verbs “*we have*” (ἔσχίκαμεν) and “*we stand*” (ἑστήκαμεν) emphasize the continuation of this new, gracious situation for believers.

Douglas Moo: God’s free giving to us does not stop when we become Christians. It continues to be poured out on us so much that we can be said to live in a constant state of grace (cf. 5:21; 6:14, 15).

Michael Bird: Here “*grace*” does not appear to mean an initial saving grace, like mercy, but something more akin to the continuing favor of God on his people. It is a grace that means we always have a VIP pass into the hallways of heavenly power.

III. (:2b-3a) WE ARE ASSURED OF FUTURE GLORY SO THAT OUR HEARTS HAVE BEEN SET FREE TO TRULY REJOICE EVEN IN PRESENT SUFFERING

A. (:2b) Rejoicing in Anticipation of Our Glorious Future

“and we exult in hope of the glory of God.”

a bright future that gives us hope in the present

Douglas Moo: Paul introduces what becomes the theme of this paragraph: the hope we have as Christians to share in God’s glory.

Frank Thielman: Boasting often has negative connotations in Romans. . . The boasting here in **5:2** is this second type of boasting (cf. **5:11**) [= positive boasting in what God has done for the believer]. God has given the believer a hope as certain as God is trustworthy (**4:18**) that believers, like the resurrected Jesus himself, will experience the incorruptible state of “glory” (τῆς δόξης) in which God himself dwells (cf. **1:23; 2:7**). Prior to believing the gospel, Paul and his readers in Rome had no hope for this eschatological glory because of their sin (**3:23**), but because of the death and resurrection of Jesus they can be sure that they will share in Jesus’s resurrection glory (**8:17, 18, 21, 30**).

B. (:3a) Rejoicing in the Midst of Present Tribulations

“And not only this, but we also exult in our tribulations,”

John Murray: Paul was a realist; he was not so absorbed in the glory of the future that he closed his eyes to the realities of the present. He was aware of the tribulations which encompassed his own life as well as the life of other believers, and the exultant joy evoked by hope could not discount the realism of the distresses and afflictions in which the pilgrimage to the attainment of that hope was cast. The remarkable feature of the attitude to tribulation is that the exultant rejoicing entertained with reference to future glory is also entertained in reference to the tribulations. Paul did not commiserate himself or other believers in the sufferings endured. Nor did he passively submit to these tribulations as trials which he recognized to be necessities of the span that separated the present from the future glory. He gloried in these tribulations and he assumed that other believers participated with him in this glorying. We find here an entirely different attitude from that which we are too liable to entertain with reference to the tribulations of the church of Christ. We pity ourselves and we pity others. Not so the apostle.

Frank Thielman: For the believer, suffering provides the basis for testifying joyfully to others about God’s ability to bring good even out of the evil that is now so prevalent.

Douglas Moo: The suffering Paul speaks of here includes all the difficulties of this life. The word Paul uses for “sufferings” in **verse 3** is the plural of *thlipsis* (tribulations). He sometimes uses this word to refer to persecution in the narrow sense—that is, difficulties experienced because of one’s witness for Christ (e.g., **1 Thess. 1:6**). Some interpreters think that most New Testament passages about suffering, including this one, have this more restrictive meaning. They are certainly right to claim that suffering “for the sake of Christ” is often the focus (see, e.g., **1 Peter**). But even in texts such as these, I am not sure that we can confine the reference to persecution.

In a certain sense, everything that a Christian suffers is “on behalf of Christ.” The evil things we face reflect the conflict between “*this age*,” dominated by Satan and sin, and “*the age to come*,” to which the believer has been transferred by faith. All suffering betrays the presence of the enemy and attacks our relationship with Christ. Furthermore, as we have argued, the end of **chapter 8** and the beginning of **chapter 5** are closely related. This means that the suffering Paul mentions in **5:3** is likely related to the trials he lists in **8:35**: “*trouble or hardship or persecution or famine or nakedness or danger or sword.*” More than persecution per se is included.

Steven Cole: There's nothing wrong with feeling sorrow or pain or grief in the midst of a difficult trial. We shouldn't deny these feelings in an attempt to look more spiritual. But through our tears and pain, we should be sustained by our hope in the promises of God. We know that He is sovereign over all things and that He cares for us. Exulting in our tribulations does not mean **denying the pain.**

IV. (:3b-4) WE HAVE A MATURING NEW CHARACTER THAT IS BEING DISCOVERED AND DEVELOPED THROUGH SUFFERING

A. (:3b) Development of Perseverance

“knowing that tribulation brings about perseverance;”

Thomas Schreiner: **The chain in verses 3–4.** First, *afflictions* produce *endurance* (ὕπομονήν, *hypomonēn*). Those who undergo troubles are toughened up so that they are able to withstand the storms of life. We have our first clue as to how troubles can spawn hope, since Paul often connects endurance with eschatological hope (**Rom. 2:7; 8:25; 15:4–5; 2 Cor. 1:6–7; 1 Thess. 1:3**). Second, endurance produces *δοκιμήν* (*dokimēn*, tested character). The word *δοκιμή* is not found prior to Paul, but it is clearly related to *δοκίμιον* (*dokimion*, testing; **James 1:3; 1 Pet. 1:7**). Elsewhere the term involves the validation or proof of one's character (**2 Cor. 2:9; 8:2; 9:13; 13:3; Phil. 2:22**). After one endures many difficulties, a **strength of character** develops that was not previously present. Such tested character in turn generates hope. Why does tested character spark hope? Because moral transformation constitutes evidence that one has really been changed by God. Thus it assures believers that the hope of future glory is not an illusion. There is a pattern of growth in the here and now, however imperfect, indicating that we are changing. Believers, then, become assured that God will complete the process he has begun (**1 Cor. 1:8; Phil. 1:6**).

B. (:4a) Development of Proven Character

“and perseverance, proven character;”

C. (:4b) Development of Hope

“and proven character, hope;”

- sufferings don't shake our confidence or produce doubt;
- instead they reinforce our hope and help us to keep on rejoicing;

Douglas Moo: Paradoxically, Paul claims at the end of verse 4, suffering can actually lead to “*hope*.” Just as resistance to a muscle strengthens it, so challenges to our hope can strengthen it.

John Piper: Isn't the answer that when your faith has been tried in affliction, and persevered, and thus proven genuine and authentic you know you are real and not a fake Christian and that gives you hope that you really are a child of God and will inherit his glory. In other words, one of the great obstacles to a full and strong hope in the glory of God is the fear that we are hypocrites - that our faith is not real and that we just inherited it from our parents and have been motivated by things that are not honoring to God. One of the purposes of afflictions in our lives is to give us victory over those fears and make us full of hope and confidence as the children of God.

So God takes us through hard times to temper the steel of our faith and show us that we are real, authentic, genuine, proven, and in that way give us hope that we really will inherit the glory of God and not come into judgment.

V. (:5) WE HAVE GOD'S LOVING SPIRIT WORKING WITHIN OUR HEARTS TO ASSURE US OF FUTURE GLORY

“and hope does not disappoint, because the love of God has been poured out within our hearts through the Holy Spirit who was given to us.”

- we are not yet perfect, but our character bears the evidence of the fruit of the Holy Spirit
- the certain hope of future glory will never disappoint us because we already possess within us the evidence of the love of God thru the Holy Spirit

Frank Thielman: When Paul says that “*hope does not bring shame,*” he is speaking of the humiliation that one feels when one’s publicly expressed expectations are not realized.

John Murray: “*The love of God*” is not our love to God but God’s love to us (cf. **vs. 8; 8:35, 39**). If we should suppose the former, the foundation of the assurance and of the security which this verse bespeaks would be destroyed. What is it that gives solidity to this hope and guarantees its validity? It is the love of God to believers, a love that suffers no fluctuation or reverse. Hence the hope which it promises is as irreversible as the love itself. This love of God must, however, come within our apprehension and appropriation if it is to be the ground of assurance and evoke this confident glorying (**vs. 2**). This is the significance of the shedding abroad in our hearts. The expression “*shed abroad*” indicates the abundant diffusion of this love. The hearts of believers are regarded as being suffused with the love of God; it controls and captivates their hearts. And the Holy Spirit as the Spirit of God and of Christ (cf. **8:9**), the Spirit who “*searches all things, yea, the deep things of God*” (**I Cor. 2:10**), is the person who sheds abroad this love, and he is the seal of its efficacy and genuineness. It is the Holy Spirit as given to us, and for that reason indwelling and governing, who imparts the assurance of this love. He bears witness to the spirit of believers that they are the children of God (**8:16**). All the elements of this verse conspire with and converge upon one another to guarantee the certitude of which the text is redolent—the unchangeable love of God, the effectual agency of the Holy Spirit as donated to us, and the heart, the determining centre of thought and life, as the sphere of the Spirit’s operation. This confluence would make anything other than exultant rejoicing incongruous. To impugn such confidence is to impugn God’s veracity.

Thomas Schreiner: **Verse 5** examines hope from another angle. The hope that believers have will not bring shame. The conception here is rooted in the OT (**Pss. 22:5; 25:3, 20; 119:116; Isa. 28:16**), where those who trust in God are assured that they will be vindicated for placing their confidence in him. . . The gift of the Holy Spirit demonstrates that believers will be spared from God’s wrath on the day of judgment. . .

The love of God is experienced when the Spirit is poured out in our hearts, indicating that the Spirit fills believers with the love of God. What Paul refers to here is the dynamic experience of

the Spirit in one's life (cf. Fee 1994: 495–98). Believers know that they will be spared from God's wrath because they presently experience God's love for them through the ministry of the Holy Spirit.

R. Kent Hughes: It is a beautiful thing to experience God's peace and grace to the extent that we exult in tribulations as well as in the hope of glory. But how do we know this joy will not someday dissolve into delusion or that it is not a pipe dream now? The answer is, these great benefits are grounded in God's unbounded love.

* * * * *

DEVOTIONAL QUESTIONS:

- 1) How does a belief in justification that includes any form of works completely undermine the possibility of any assurance of salvation?
- 2) What is the impact of justification by faith on our past, present and future?
- 3) Are we relying today on our standing in the grace of God?
- 4) What can we learn about ourselves from our response to trials and suffering?

* * * * *

QUOTES FOR REFLECTION:

Douglas Moo: Paul's exposition of the gospel of Jesus Christ takes a decisive turn at **5:1**. Up to this point, his focus has been on the power of the gospel to put people who are locked up in sin and under sentence of God's wrath into a right relationship with God. Through the preaching of the good news, God invites all people—Jew and Gentile alike—to believe in Christ and enter into this new relationship. Now Paul turns his attention to what comes after one's justification by faith. **Chapters 5–8** focus on two matters in particular: the certainty we can have that our justification will lead to final salvation, and the new power God gives us in our continuing struggle against sin and the law.

The first theme—what theologians call “**assurance**”—dominates the first (**5:1–11**) and last (**8:18–39**) paragraphs in these chapters. These two sections frame the argument of **Romans 5–8**, forming what we call an *inclusio*. The famous argument about Adam and Christ (**5:12–21**) grounds the claim for assurance in **5:1–11**. Then, in **chapters 6–7**, Paul deals with two continuing threats to our assurance: sin and the law. In **8:1–17** he shows how the work of God's Spirit overcomes these threats. As we hope to show in the sections that follow, this way of reading the argument of Romans makes better sense than the traditional division of the first part of the letter into sections about “*justification*” (**chs. 1–5**) and “*sanctification*” (**chs. 5–8**).

Michael Gorman: Summary of Romans 5-8

TEXT	NARRATIVE PERSPECTIVE	DEATH-LIFE ANTITHESIS	THEMES (A) JUSTIFICATION AS . . . (B) NEW LIFE AS . . .	CHRIST'S DEATH AND RESURRECTION
5:1-11	overview	being God's enemies vs. being God's reconciled friends	(a) inclusive of reconciliation (b) the experience of peace, love, and hope	Christ's death as God's love
5:12-21	cosmic, apocalyptic, and salvation historical	Adam = death vs. Christ = life	(a) the gifts of acquittal, righteousness, and life (b) being free from Sin, under grace (anticipating ch. 6)	Christ's death as his obedience
6:1-7:6	participation-ist: baptismal	slavery to Sin = death vs. slavery to righteousness = life	(a) liberation from Sin, and as a death and resurrection (b) being liberated from, and dead to, Sin; being enslaved to, and alive to, God	believers' co-crucifixion and co-resurrection with Christ ⁶
7:7-8:39	participation-ist: existential (practical)	flesh = death vs. the Spirit = life	(a) inhabitation by the Spirit and fulfilling the just requirement of the law (b) living in the Spirit, not in the flesh	believers' death to the old life and new life in the Spirit, co-suffering with Christ in anticipation of full and final glory

John Toews: Suffering normally produces shame in an honor-shame culture, because the superior, the one holding honor, is humiliating the inferior. The end-time suffering in Rome that is associated with the reversal of the honor-shame code, that is, welcoming the inferior, does not produce shame (unfortunately, often translated as “*not let us down*”) for Christians, because God’s love has been poured into our hearts. “*The love of God*” refers to the character of God (a subjective genitive). God is love. “*Poured out*” (*ekkechutai*) is normally used with God’s wrath (Ps. 79:6; Ezek. 7:8; Rev. 16, eight times), never with God’s love. But, it is used with the coming of the Holy Spirit (Joel 2:28-29; Acts 2:17-18, 33; 10:45; Tit. 3:5-6), which explains its use here. The tense of the verb (**perfect**) suggests an ongoing state that is the result of a once-for-all event.

The coming of the Spirit is a **mark of the end-time** in Judaism (**Isa. 32:15; 34:16; 44:3; Ezek. 11:19; 36:26-27; 37:4-14; Joel 2:28-32**) and the early church; Paul speaks elsewhere of the Spirit as a “pledge” or “guarantee” (**Rom. 8:23; 2 Cor. 1:22; 5:5**). Jewish and Gentile Christians experience the love of God by means of the gift of the endtime Spirit. The proof that hope will not be shamed is that God loves by giving the Spirit to people of differing socio-economic groups. The presence of the Spirit is the first evidence of God’s love. Followers of Jesus experience this love at the deepest center of their lives, “*in their hearts,*” and as the fulfillment of the new covenant promises to Israel (**Jer. 31:31-34**).

Leedy Greek NT Diagrams:

Rom 5:1-2

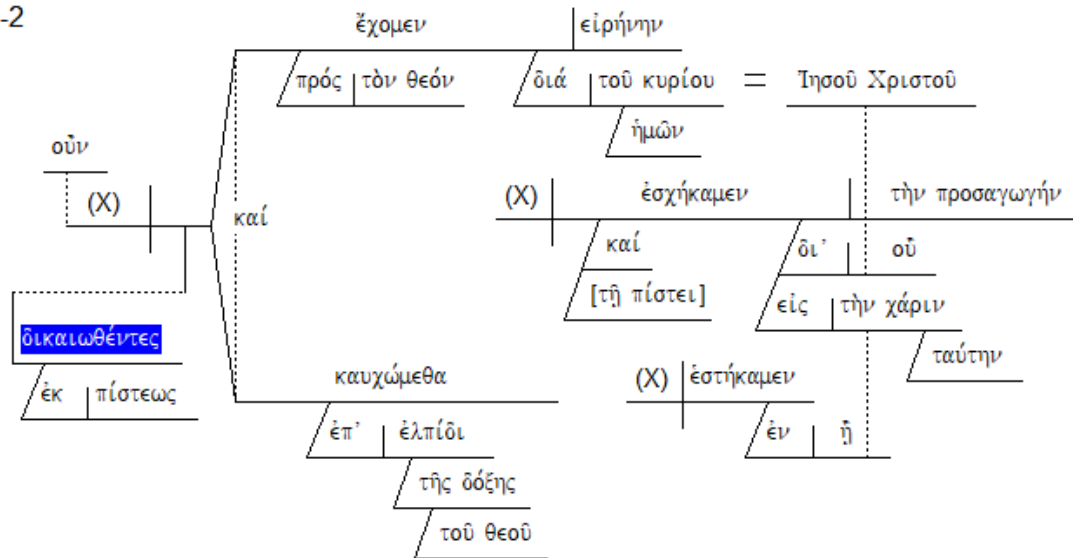

Rom 5:3-4

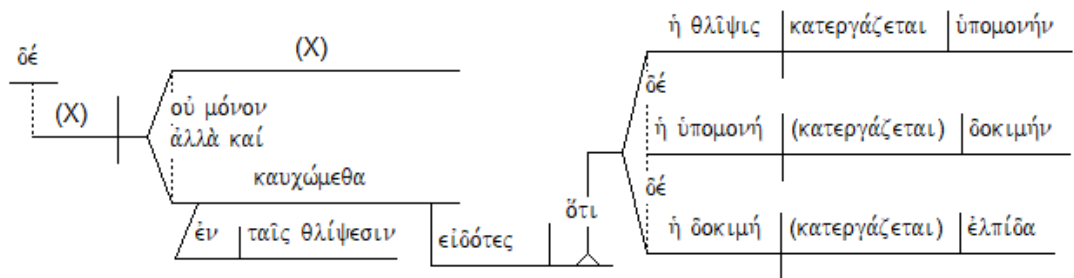

Rom 5:5

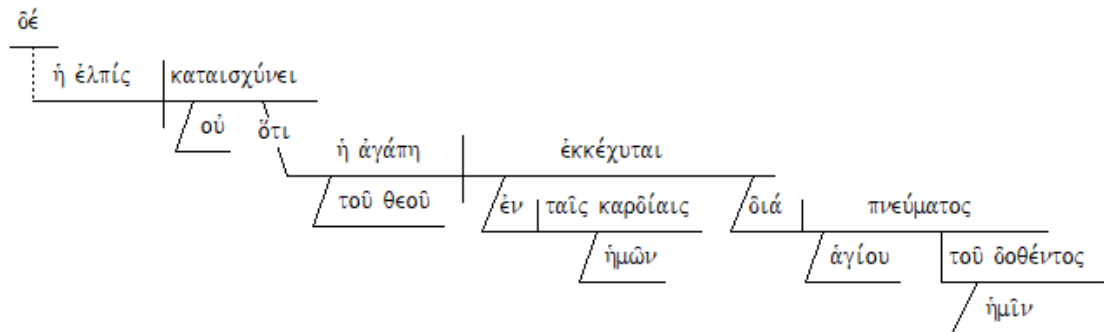

TEXT: ROMANS 5:6-11

TITLE: SECURE IN GOD'S LOVE – CONFIDENCE IN FACING THE FUTURE

BIG IDEA:

THE SECURITY OF CHRIST'S LOVE ALLOWS US TO FACE THE FUTURE WITH JOYFUL CONFIDENCE

INTRODUCTION:

A lesson of reassurance for believers: If Christ demonstrated his love for us in the past, when our condition was awful, how much more will Christ continue to love us into the future, now that our relationship with God is restored. Thus, the certainty of Christ's love frees us to rejoice in the present and face the future with confidence. **Verse 5** was a good transition verse leading into this second half of the paragraph of **5:1-11**.

Thomas Schreiner: **Verse 6** is closely connected to the preceding, as the *γάρ* (*gar, for*) attests. **Verse 5** affirms the subjective apprehension of God's love in conversion. Now in **verses 6–8** the objective ground of that love is introduced: the death of Christ for sinners. The experiential character of God's love does not float free from an anchor in history; it is rooted in the objective work of Christ on the cross. The overall flow of thought in **verses 6–8** is easily discerned. In **verse 6** Christ is said to die for the weak and ungodly. **Verse 7** contrasts this with human love, which occasionally sacrifices life for a righteous or good person. **Verse 8** reiterates **verse 6**, emphasizing the uniqueness of God's love in sending Christ to die for sinners. **Verses 9–10** draw the conclusion from the love of God revealed in the cross. Since he has justified and reconciled us to himself, we will certainly be spared from his wrath on the day of judgment. The greatness of our hope and the depth of God's love cause us to rejoice and exult in God's work on our behalf through our Lord Jesus Christ (**v. 11**). . .

The argument, then, can be portrayed as follows:

The experience of God's love increases hope (**v. 5**).

The death of Christ for sinners proves that this hope has an objective ground (**vv. 6–8**).

Therefore, believers can be sure that their hope will be realized and they will be preserved from God's wrath (**vv. 9–10**).

F. F. Bruce: And why not rejoice in God? His people have been reconciled to Him by the death of Christ, and experience daily deliverance from evil through the resurrection life of Christ, while the end to which they confidently look forward is no longer the outpouring of divine wrath but the unveiling of divine glory. And from first to last they ascribe their blessings to God's love. It was because of that love that Christ laid down His life for them while they were weak, sinful and completely unattractive. The love of men and women will go to death itself for those who are the natural objects of that love, but not for the unlovely and unloving. Yet this is where the love of God shines brightest: God confirms His love to us in the fact that Christ died for us while we were in a state of rebellion against Him. So entirely at one are the Father and the Son that the self-sacrifice of the one can be presented as a token of the love of the other. And

indeed, throughout the New Testament the death of Christ is the supreme manifestation of the love of God: “*Herein is love,*” says John, “*not that we loved God, but that he loved us, and sent his Son to be the propitiation for our sins*” (1 Jn. iv. 10). What a perversion of the divine character is perpetrated by those who sometimes talk as if Christ died for men in order to make God love them! That a change in the relation between God and man is brought by the death of Christ is clearly taught here and elsewhere; but no change was involved in the reality of God’s love.

I. (:6-8) SECURITY BASED ON CHRIST’S DEATH FOR US – CHRIST DIED TO SHOW HIS LOVE FOR US IN THE PAST – WHILE WE WERE POWERLESS AND UNDESERVING ENEMIES

A. (:6) Marvelous Love of Christ Unfathomable

1. Pathetic Souls – Christ Died for the Helpless

“*For while we were still helpless,*”

Michael Gorman: Paul offers a quartet of images to describe those for whom Christ died:

- weak/powerless (5:6)
- ungodly/godless (5:6; cf. 1:18; 4:5)
- sinners (5:8)
- enemies of God (5:10; cf. “*God-haters*” in 1:30).

Frank Thielman: The conjunction “*for*” (γάρ) ties this sentence to what Paul has just said about God’s love and introduces Christ’s death as the concrete demonstration of that love. The unusual repetition of “*still*” (ἔτι) and the phrase “*at the right time*” (κατὰ καιρὸν) reveals the emphasis that Paul places on the **timing of Christ’s death**. Christ died for Paul and his readers when they were “*weak*” (ἀσθενής) and “*impious*” (ἀσεβής). Paul often uses the term “*weak*” to mean “*without adequate faith*” (1 Cor 8:7, 9–12; 9:22; cf. 1 Thess 5:14) and will speak later in Romans of the believer who is “*weak in faith*” (14:1–2; cf. 15:1). Here the term refers not to those with inadequate faith but to those who, like the people that practice “*impiety*” (ἀσεβεία) in 1:18, **have no faith at all**. The people Paul described in 1:18–32 were without hope when left to themselves, moving in a downward spiral from bad to worse. The weakness to which Paul refers, then, is an **inability for people to reconcile themselves to God** (cf. Eph 2:1–3, 11–12; 4:17–19; Col 1:21; 2:13a; Titus 3:3).

2. Perfect Timing

“*at the right time*”

Thomas Schreiner: Ascertaining the particular meaning of the phrase “*at the right time*” (κατὰ καιρὸν, *kata kairon*, v. 6) is difficult. It could mean that Christ died at the right time in terms of God’s plan for the world (cf. Rom. 3:26; 8:18; 13:11; Gal. 4:4), fulfilling the promises made in the Scriptures (Murray 1959: 167; Cranfield 1975: 264; Matera 2010: 133; S. Porter 2015: 118). Others think the appropriateness of the time relates to the weakness of the ungodly, in that he died at the right time to rescue them from their peril. We probably face a false dilemma here. God not only planned when Christ would die but also had in mind the people for whom his death would be effective. In any case, the emphasis is on the greatness of God’s love for his people.

3. Pathetic Souls – Christ Died for the Ungodly

“Christ died for the ungodly.”

John Murray: Hence the love of which the death of Christ is the expression and provision is a love exercised to them as ungodly. It is not a love constrained by commendable qualities in them, not even by the qualities which they would one day exhibit by the power of God’s grace. It is an antecedent love because it is the love presupposed in the death of Christ for them while they were still in misery and sin. It is not the love of complacency but love that finds its whole urge and incentive in the goodness of God. That is the kind of love the death of Christ demonstrates and it is a love efficient to a saving purpose because the death of Christ is on behalf of the ungodly and therefore to the end of securing the high destiny which the context has in view.

B. (:7-8) Marvelous Love of Christ Unprecedented

1. (:7) Example of Supreme Human Love

*“For one will hardly die for a righteous man;
though perhaps for the good man someone would dare even to die.”*

John Murray: The terms of the text would appear rather to support the view that no such sharp contrast is drawn between the righteous and the good but that these two epithets are used to designate the same individual as both righteous and good. And the thought of the text would be that among men it is scarcely true that one will die even for a righteous and good man, far less for a godless, wicked person. But perchance it may happen that for such a good man one will die. The constraint of respect and esteem may cause one to die on behalf of another. It is on this background of concession that the complete contrast between the human and the divine appears, and that is the force of **verse 8**.

2. (:8) Unprecedented Nature of Sacrificial Divine Love

*“But God demonstrates His own love toward us,
in that while we were yet sinners, Christ died for us.”*

Frank Thielman: The overall effect is a cautiously worded statement about the unprecedented nature of Christ’s death for the impious. Justice, goodness, and piety all go together as highly admired virtues in the first-century Greco-Roman world. Paul’s point is that for someone to die for a person who is virtuous in these ways is rare enough, but Christ’s death for the impious is unique.

Thomas Schreiner: The idea behind ὑπέρ is that Christ died both as our representative and as our substitute. The suffering of Christ was not only exemplary but also accomplished atonement for sinners; **he took the punishment we deserved**.

John Witmer: God’s love contrasts with human love in both nature and degree.

II. (:9-10) SECURITY BASED ON CHRIST’S CURRENT LIFE FOR US – CHRIST LIVES AND WILL SURELY SHOW HIS LOVE FOR US IN THE FUTURE –

NOW THAT OUR RELATIONSHIP WITH GOD HAS BEEN RESTORED

A. (:9) Deliverance from Future Wrath Assured

1. Christ's Past Work Guarantees His Future Promises

"Much more then,"

R. Kent Hughes: In **verses 9, 10** Paul uses an argument that the rabbis called *kal wahomer*, which means "light and heavy"—an argument from the lighter to the heavier. We call it today in legal terms an *a fortiori* argument. We say, "If it was true in one place, it will be true in another." Paul's arguments in **verses 9, 10** are virtually identical and hinge on the term "*much more.*"

2. Justification is Christ's Past Work on Our Behalf

"having now been justified by His blood,"

3. Deliverance from Wrath is Christ's Promise for Our Future

"we shall be saved from the wrath of God through Him."

"*the wrath of God*" -- refers to God's final judgment and condemnation of sinners to eternal punishment

John Murray: The main thought of **verse 9** is, however, in the conclusion that is to be drawn from the foregoing—"how much more . . . shall we be saved through him from the wrath". This refers to what will be true in the future as compared with what is true now in the present. Now we are justified—accepted with God as righteous and therefore at peace with God. And this guarantees future salvation. What is the salvation in view? "*The wrath*" spoken of indicates the answer. The wrath is the wrath that will be dispensed to the ungodly at the day of judgment, the eschatological wrath (**2:5, 8; I Thess. 1:10; 5:9**; cf. **Matt. 3:7; Rev. 6:16, 17; 11:18**). And the assurance to be derived from a present justification—whether viewed as the justification which consists in the blood of Christ or as the justification secured by that blood—is that no wrath is reserved for the justified at the judgment seat. Justification is the opposite of condemnation and since justification is complete and irrevocable there is no condemnation reserved for those who are in Christ Jesus (cf. **8:1**). It is symptomatic of the confidence expressed in **verses 2 and 5** in reference to the hope of the glory of God that the apostle should now explicate another aspect of that hope, namely, the assurance of deliverance from that which epitomizes the displeasure of God and alienation from him. It was not irrelevant for the apostle to speak in terms of negation as well as affirmation. The hope of glory is negative as well as positive. In order to be positive it must be negative of all that sin entails. In order to be salvation to it must be salvation from. And nothing sums up this "*from*" more significantly than the concept of the wrath of God. It was a virile conception of God that the apostle entertained and, because so, it was one that took account of the terror of God's wrath. Salvation from the future exhibition of that terror was an ingredient of the hope of glory.

B. (:10) Divine Favor Assured Going Forward

1. Divine Favor Granted by Christ's Death While We Were Enemies

*"For if while we were enemies,
we were reconciled to God through the death of His Son,"*

2. Divine Favor Now Assured by Christ's Life Since We Are Friends

"much more, having been reconciled, we shall be saved by His life."

"*much more*" = the key point of the parallels Paul draws thru the remainder of the chapter

John Murray: the guarantee of the final and consummated salvation is the exaltation life of Christ. This is a more embracing way of expressing the truth that the guarantee of the believer's resurrection is the resurrection of Christ (cf. **I Cor. 15:20–24**).

James Stifler: The argument here is in the form of a **triple antithesis**, like that in **Mark 7:8**. . .

- (1) if God could do so much for His enemies, what can He not do now for those who are in a reconciled state?
- (2) if God could become reconciled with men when enemies, can he not remain reconciled (which insures their being "saved") now that they have become friends?
- (3) if the death of Christ, a negative power, could do so much (reconcile), what will not His life, his active energy on high in their behalf, what will not His ever-living insure?

This threefold antithesis in argument is not merely three times as weighty as a single one, but nine times.

III. (:11) SECURITY BASED ON CHRIST'S FINISHED WORK OF RECONCILIATION – CAUSES US TO REJOICE IN THE PRESENT

A. Blessings Based on Justification Keep Abounding

"And not only this,"

B. Boasting Unleashed

"but we also exult in God through our Lord Jesus Christ,"

Frank Thielman: As if future salvation from God's wrath were not enough, God's gracious gift of a peaceful, reconciled relationship with him provides believers with a reason to praise God in the present.

Thomas Schreiner: The capstone of the believer's experience is boasting and exulting in God himself. The greatest good for believers is fellowship with God, and he receives the glory and praise that sinful human beings have so long denied him (**1:21–23; 2:24; 3:23**).

John Murray: It is this consideration of present privilege that explains the exultant joy in God referred to in the preceding clause and it is scarcely possible to relegate it to the future. If we bear in mind that exultant glorying is a prominent feature of this passage—"we exult in hope of the glory of God" (**vs. 2**); "we glory in the tribulations" ()—we should expect that, after unfolding the relationship to God constituted by reconciliation **vs. 3** and when the note of exultant joy is resumed, the apostle should give expression to the confident rejoicing in God which the privilege now possessed must constrain. Glorying knows no restraint and cannot be too exaggerated when it is in God through our Lord Jesus Christ (cf. **I Cor. 1:30, 31**). It is not only

that God is the object of this glorying; it is not only that he is the ground of it; it is in union and fellowship with him as our own God that the glorying is conducted.

John Toews: Boasting in one's ethnic or social status is excluded by Paul. The only legitimate boasting is "bragging" about what God has done in Christ.

William Hendriksen: Not all glorying or boasting can be recommended, however. As **Rom. 2:17, 23** had indicated, Jews were boasting or bragging about the fact that they, in distinction from all other nations, possessed God's holy law. In the church at Corinth there were people who bragged about Christian leaders (**1 Cor. 3:21**), and about special gifts or attainments (**II Cor. 11:18**). An in his letter to the Galatians Paul refers to men who bragged about the number of Gentiles they had "converted" (caused to be circumcised, **Gal. 6:13**). Does that sound up-to-date?

Over against all such sinful leaping for joy Paul informs the Romans "*We exult in God through our Lord Jesus Christ.*" And indeed, if, in speaking about the blessed results of Christian labor, one constantly keeps his attention focused on Jesus Christ, God's Chosen Servant, who was the very opposite of a boaster (**Matt. 12:18-21; Phil. 2:5-8**), and derives all his power from him, all will be well.

C. Basis = Our Accomplished Reconciliation

"through whom we have now received the reconciliation."

Frank Thielman: Instead of tying boasting to present afflictions as he did in **5:3** Paul now ties it to reconciliation, the theme that dominated **5:10** and that he foreshadowed in **5:1** when he described the "*peace with God*" that characterizes those who have been justified by faith. Believers boast in the present, then, not only because of their future hope of sharing in God's incorruptible state of glory (**5:2**) or because present suffering is instilling patience, character, and hope in them (**5:3-5**) but also because they presently possess reconciliation with God. This reconciliation comes at God's initiative, and therefore believers boast not in themselves or that they, and not others, are the ones reconciled (cf. **11:18**) but in God who initiated and achieved the reconciliation (cf. **1 Cor 1:29-31**). God did this "*through our Lord Jesus Christ,*" that is, through his sacrificial, justifying death, as Paul has explained in **5:8-10**.

Since Christ has shown His love in the past and assures us of His love in the future, we are now free to rejoice in the present.

* * * * *

DEVOTIONAL QUESTIONS:

- 1) How do the Scriptures characterize the condition of your life prior to salvation?
- 2) What are the force of the "*much more then*" arguments that Paul offers here?

- 3) How secure are you in Christ's unconditional love for you?
- 4) How can you use these verses to prove that all Christians have received the Holy Spirit (in refutation of the Pentecostal claim that only some believers have the Holy Spirit).

* * * * *

QUOTES FOR REFLECTION:

Steven Cole: vv.9-11 – Assurance of Salvation

Our text is one of the strongest arguments for assurance of salvation in the Bible. **Martyn Lloyd-Jones** wrote (*Romans: Assurance* [Zondervan], p. 128), “The argument of these two verses [9 & 10] is, I suggest, the most powerful argument with respect to assurance of salvation, or the finality of our salvation, that can be found anywhere in the whole of the Scripture.” He goes on to say that the only thing that goes beyond it is the immediate witness of the Holy Spirit, which Paul mentions in **Romans 8:16**. Since being assured of your salvation is an important part of the foundation for spiritual growth, it is vital that you understand and apply the verses that we are studying here.

Before we examine Paul's argument, let me give you a brief overview of my understanding of the basis for assurance of salvation. There are three aspects to it: First and foremost, have you **trusted in Jesus Christ** alone and His death in your place to forgive all your sins and clothe you with His righteousness?

If you answer “yes,” then there is a secondary basis for assurance: What **evidence** of the new birth do you see in your life? While we never will be perfectly sanctified in this life, there should be some definite signs of the new birth: a growing love for God, a desire to know Him through His Word, a desire to please Him by keeping His commandments, a growing love for others, a growing hatred of sin, etc. The “tests” of First John fit into this category, along with the qualities of **2 Peter 1:5-11**.

Third, there is the **witness of the Spirit**, who “*testifies with our spirit that we are children of God*” (**Rom. 8:16**). While this aspect of assurance is partly subjective and therefore subject to error, I understand it to be based on the objective promises of God. This inner witness of the Spirit is when He takes the promises of salvation in the Bible and testifies to your spirit, “Yes, these are true and by God's grace I rest on them!” Or, the Holy Spirit assures you by reminding you of how He has worked the signs of new life in you.

Our text falls under the first basis for assurance, as Paul enumerates the blessings of being justified by faith (**5:1**). He takes these blessings a logical step farther by arguing from the greater to the lesser, as we can see by the twice repeated, “*much more*” (**5:9, 10**). He reasons, “If we were justified by Christ's blood when we were yet sinners and if we were reconciled to God by the death of His Son while we were His enemies, then we can expect to be saved from God's wrath by the risen Savior.” It is also an argument from the past to the future: If in the past God loved us and Christ died for us when we were sinners, then we can expect that in the future He will keep us from judgment as those who have been reconciled to Him. This, in turn, causes us to

“exult in God through our Lord Jesus Christ, through whom we have received the reconciliation” (5:11).

Thus,

If as God’s enemies we were saved through the death of His Son then, praise God, as His friends the risen Savior will save us from future judgment.

William Hendriksen: What Paul is saying is that God’s love, as revealed in Jesus Christ, is both **unprecedented** and **unparalleled**. No merit from our side could have moved Christ to die for us, for he died for us *“while we were still sinners.”* Moreover, he died for us *“at the appointed time,”* that is, at the time appointed by God (cf. **Mark 1:15; Gal. 4:4**), not by us.

This death was unparalleled with respect to the marvel of the implied condescending and pardoning grace. Christ died for those who were bad, bad, bad! In them there was no goodness that could have attracted this love. In the death of Jesus for sinners God demonstrates *“his own”* sovereign love. See **Isa. 1:18; 53:6; 57:15; Dan. 9:17-19; 1 John 4:10**.

Note the word *“demonstrates,”* present tense. Although it is true that for Paul, at the time he wrote this letter, as well as for us today, the death of Christ was an event that had occurred in the past, its lesson remains an ever present and glorious reality.

John MacArthur: The Security of Salvation

I suppose we could understand it if God were to love the good and God were to love the godly and God were to love the pure. But the mystery of divine love is that He loved the folks that were the opposite of all of that. The great theologian and commentator **Hodge** has said this, "If God loved us because we loved Him, He would love us only so long as we loved Him and on that condition, and then our salvation would depend on the constancy of our treacherous hearts, but as God loved us as sinners, as Christ died for us as ungodly, our salvation depends, not on our loveliness, but on the constancy of God's love." Oh. I love that. You see, God doesn't love you because you're so lovely, me neither. . .

Now listen carefully, if there was nothing in us to attract Him to love us in the first place, what could there be in us to make Him stop loving in the second place? Couldn't be anything. You see the point he's making? I mean, if Christ died for us when we were ungodly, impotent, ugly sinners and God could love us then, is it going to be any problem for Him to love us now? Christ died... I love that, the end of **verse 6**, underline it, *“Christ died for the ungodly.”* Oh, that's great.

. . .

Now, what is this saying? Here it comes. If Jesus saved us in His death, don't you think He could keep us in His life? In other words, if a dead Savior on the cross can redeem us, can't a living Savior keep us? A great truth, isn't it? If Jesus in death provided our salvation, what can He be doing now in glorified resurrection life? You see, that's the whole point. If He could save us in His death, He can keep us in His life. Great truth. . .

So, we're **secure**, kept by God because He's faithful. And the means by which He keeps us? Peace with God, standing in grace, hope of glory, possession of love, certainty of

deliverance, and a last one in **verse 11**. We'll just call it joy in God. "*And not only so,*" and this is, you know, this is more than you can bear, if that isn't enough. "*Not only so,*" says Paul, "*we also joy in God through our Lord Jesus Christ by whom we've now received the reconciliation.*" And here's another subjective reality, another reason that we know we belong to God, is because He fills our heart with joy. The fruit of the Spirit is what? Love, joy, peace, joy. And again I say, salvation is not merely a future though certain good, it is a present and abundant joy. And one of the ways that you know you belong to God and one of the great securities is that internal joy.

S. Lewis Johnson: Do you have the same **assurance** of which Paul is speaking? Do you know that you were once an enemy, and the Holy Spirit has brought you to a state of friendship or enmity with this wonderful triune God through Jesus Christ? Do you know the forgiveness of sins? Do you know reconciliation? Do you know what it is to be justified? Do you know what it is to know that Christ has died for you? Do you know that you're a sinner? Do you know that you're ungodly in yourself? Do you know that you're helpless and you cannot believe of yourself? Do you know that your case is hopeless? Have you come to the place where, recognizing that, you have fled to the God who is able to save to the uttermost? We invite you to come to him. He's offered the atoning sacrifice, the sacrifice that puts away sin. It's made for sinners. And if you recognize that you're a sinner, ungodly, helpless, that sacrifice is for you.

Steve Lawson: God's Love Demonstrated

What Paul is doing is giving the reason why the love of God is so great and so rich and so unparalleled and so unprecedented. He doesn't want to just say, "The love of God," and move on. When he says, "The love of God," in **verse 5**, he just has to pull over and park and open that up for us the riches. This is something like **Ephesians 3** that we would know the height and the depth and the breadth and the length of the love of God toward us and Christ Jesus," that's what this little section is. **Verses 6-11** is what we call a **literary unit**. It's like a paragraph. It's like a unit of thought. Many of you in your own Bible will have it broken out by the translator into a separate paragraph.

That's what **verses 6-11** is. But what I want you to see is that it really is the commentary on **verse 5**. Tell us about this love of God. As we look at **verse 6**, it's the first explanation. **verse 7** will be the second explanation. And then **verse 10** will begin the third. There's a three-fold opening up and explaining, describing, this extraordinary love of God. . .

It would be easy just to look at the unconverted world and go, "Yeah, yeah, they are in sin." Paul here is reminding the Romans that this is true of us as well – once was true of us. He says, "We were – for while we were still helpless –". Now Paul's going to use four words here to describe what we were, the way we were before we were converted. I've drawn a circle around them in my Bible here. In **verse 6** are two of these words, *helpless* and *ungodly*. Do you see that? And then in **verse 8**, *sinners*; and **verse 10**, *enemies*. That's pretty potent.

This is what we once were; **helpless, ungodly, sinners, and enemies**. It's a package deal. All four of these represent what we once were. It's not two of the four, one of the four, three of the four; it's across the board package deal, all four.

Leedy Greek NT Diagrams:

Rom 5:6

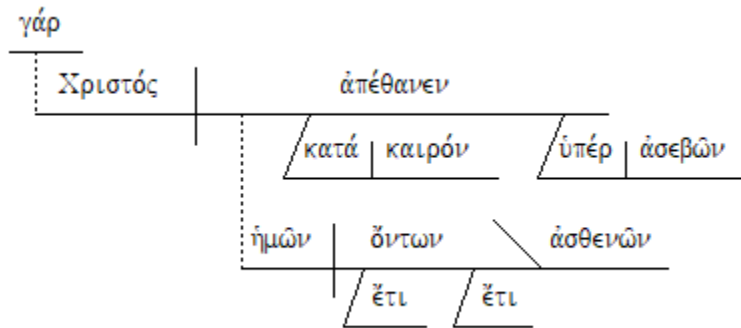

Rom 5:7-8

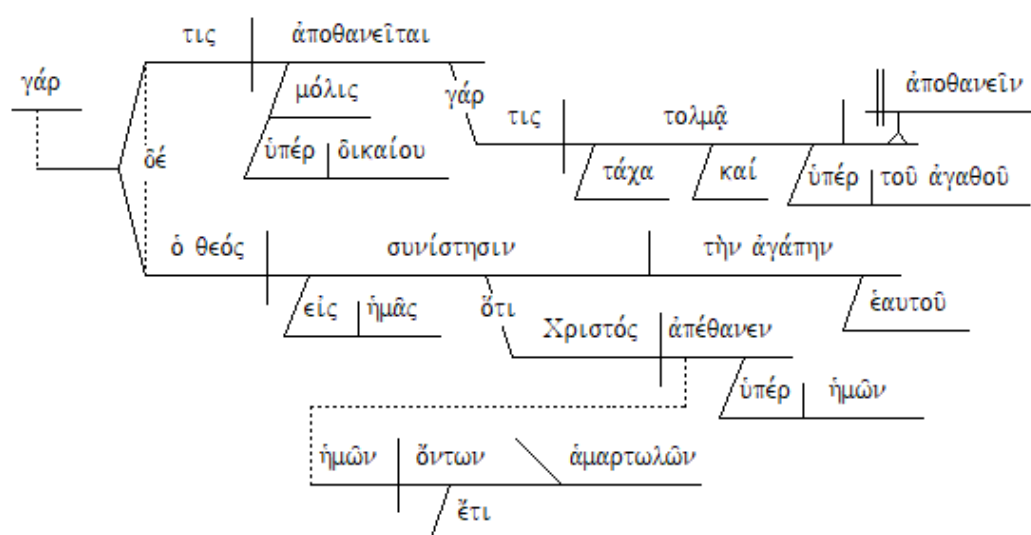

Rom 5:9

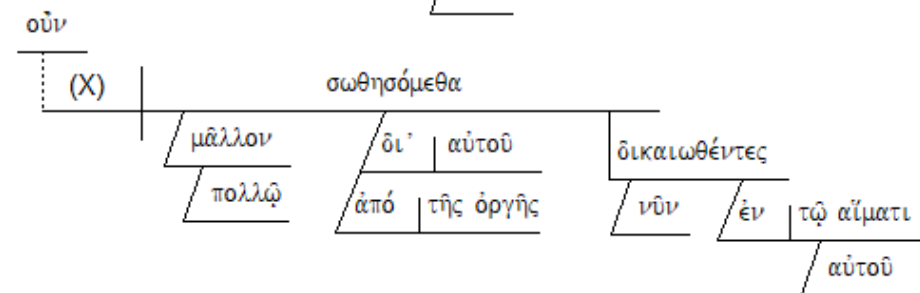

Rom 5:10-11

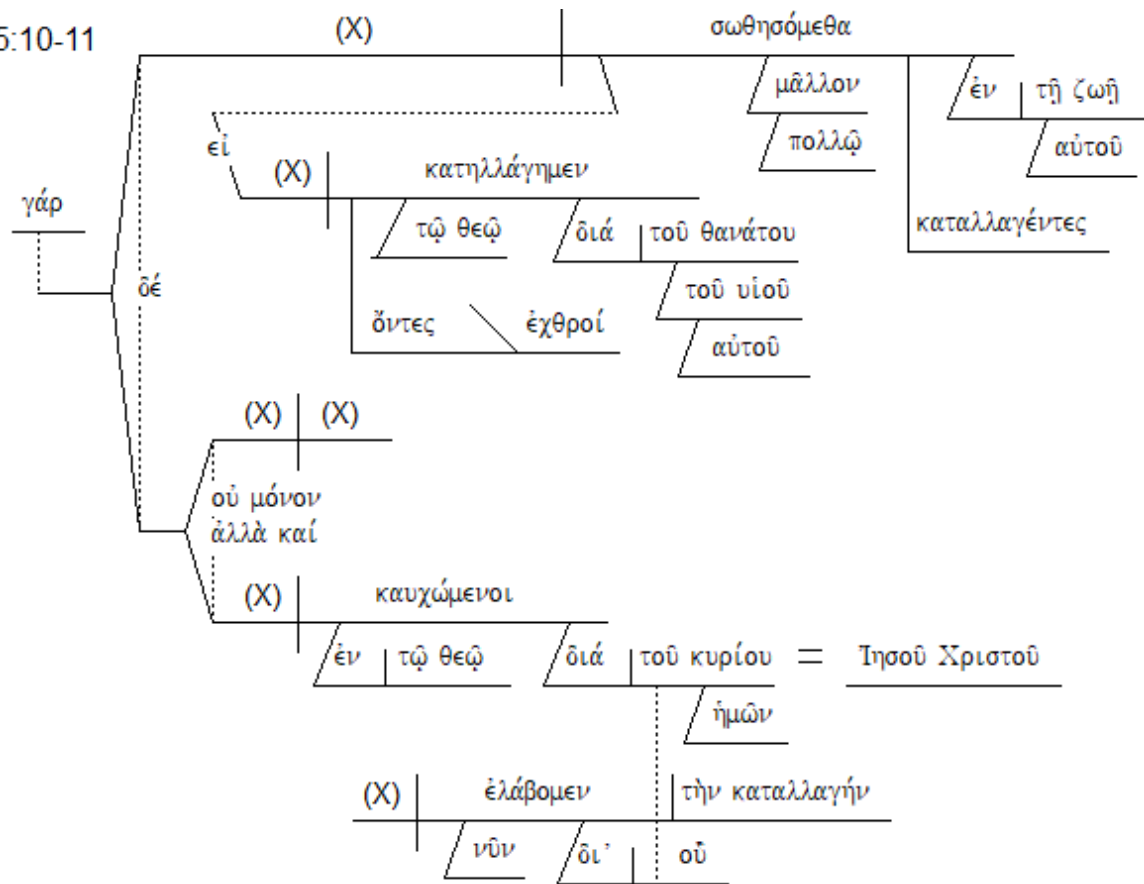

Frank Thielman:

6a Time (Specific)	For	while we were still weak,
b Time (General)		at just the right time,
c Basis (for 5a–b)		Christ died for the impious.
7a Explanation (of 6c)	For	only rarely
		will someone die
b		for a just person,
c Advantage		
d Contrast (with 7a)	but	for a benefactor
		someone might even perhaps dare to die.
8a Contrast (with 7a–b)	But	God demonstrates his own love for us
b Explanation (of 8a)		in that while we were still sinners Christ died for us.
9a Comparison/Result	therefore,	How much more,
b Cause (of 9c)		having been justified now
Means (of 9b)		by his blood
c Promise		shall we be saved
d Agency		through him
e Separation		from God's wrath.
Time		
10a Restatement of 8b as	For	if, while we were enemies,
Condition of 10d		we were reconciled to God
b Means		through the death of his Son,
c Comparison/Cause		how much more,
Circumstances		having been reconciled,
Exclamation		shall we be saved
d Means		by his life.
11a Contrast	And	not only so, but
b		we also boast
c Sphere		in God
d Agency		through our Lord Jesus Christ,
e Description		through whom we have now received the reconciliation.

TEXT: ROMANS 5:12-21

TITLE: TRIUMPH OF GRACE OVER SIN

BIG IDEA:

OUR SOLIDARITY WITH CHRIST ASSURES OF GOD'S GIFT OF RIGHTEOUSNESS AND LIFE EVEN MORE THAN OUR SOLIDARITY WITH ADAM BROUGHT SIN AND DEATH

INTRODUCTION:

Frank Thielman: The two paragraphs, however, are closely tied together logically and thematically. Logically, 5:12–21 advances the argument of 5:1–11 by explaining an important implication of the reconciliation that believers have experienced through the atoning death of Christ. “*Because of this*” costly act of reconciliation (5:12), the disaster of sin and death that Adam brought on all humanity has started to be reversed. Through the death of Christ (his “*righteous act*” or “*obedience*” [5:18, 19]), believers already experience the free gift of God’s grace (5:15), justification (5:16, 18, 19), and life (5:18, 21), although through the use of the future tense in 5:17 (“*will . . . reign in life*”) Paul shows that the reversal of the consequences of Adam’s transgression is not yet complete.

Thematically, 5:12–21 continues to emphasize the generous nature of God’s grace and love that played an important role in 5:1–11. In 5:5 Paul had spoken of God’s love as “*poured into*” believers’ hearts, emphasizing its lavish nature, and in 5:7–8 he had described God’s love as so great that Christ died for believers while they were sinners. In the same way, Paul’s qualification of his comparison between the universal effects of Adam’s trespass and Christ’s righteous act in 5:12–21 focuses on how God’s grace does not simply meet the disastrous effects of Adam’s sin measure for measure but overwhelms it with an abundance of grace (5:15–17, 20). . .

In this paragraph Paul demonstrates an important consequence of God’s gracious initiative to reconcile people to himself through the death of Christ. The atoning death of Christ has reversed Adam’s introduction of sin and death into the world. This reversal, moreover, does not merely correct Adam’s misstep and its consequences but overwhelms them with the lavish grace of God. God has decisively defeated the power of sin and death and brought the era of their reign to an end. Now the era of the eternal reign of God’s grace has begun.

Thomas Schreiner: Thus the view that Adam functioned as the **covenant head** of the human race is most satisfactory (S. Johnson 1974: 312–13). Adam as the head of the human race sinned as **our representative**, and we are sinners by virtue of being in **corporate solidarity** with Adam. Many theologians have explained the connection in terms of the **imputation** of Adam’s sin to his descendants. This explanation accounts for the wording of the text, which repeatedly attributes death and condemnation to Adam’s one sin. It accounts for the analogy between Adam and Christ, for just as Adam functions as the covenant head of the human race, so too does Christ. Finally, it also explains why only Adam’s first sin was imputed and not the rest of his sins. It seems that the corporate solidarity of the human race is undeniable. We are all affected by the

sins and actions of our ancestors, and this is supremely and particularly the case in terms of our relationship to Adam. Thus all people inevitably sin because they enter the world alienated from God.

Douglas Moo: These verses highlight Christ's power as the "*second Adam*," who more than reverses the dire consequences of the first Adam's sin, to ensure that those in him will have eternal life (vv. 20–21). This argument functions naturally as the basis for what Paul has said in **verses 1–11**: Our hope of sharing God's glory is certain because we are in Christ, who has guaranteed life for us. This appears to be the best reading of the sequence of thought in **chapter 5**. We can therefore paraphrase the opening words of **verse 12**: "in order to accomplish what I have just taught [e.g., the certainty of salvation]...."

Christ is like Adam in that what he did affects all people. But, unlike Adam, who brought death, **Christ brings life**. Therefore, all who belong to Christ can be confident that they are under the "*reign*" of grace, which brings eternal life (v. 21). . . . The power of God's grace operating through the work of Christ means there is a "how much more" in the quality of what Christ accomplishes in comparison with what Adam has done (v. 17). Christ more than cancels the effects of Adam's sin—he enables those who have received the "*abundant provision of grace*" and "*the gift of righteousness*" not just to experience life but to "*reign in life*."

I. (:12-14) THE ADAM BOMB -- ADAM'S SIN HAD GRAVE EFFECTS UPON US

A. (:12) Sin and Death Invaded the World Through Adam

1. Entrance of Sin and Death

"Therefore, just as through one man sin entered into the world, and death through sin,"

2. Spread of Sin and Death

"and so death spread to all men, because all sinned—"

What is the nature of our Solidarity with Adam?

Various attempts to explain our link with Adam's sin:

- 1) **Seminal / Genetic View** -- stresses our natural, physical, genetic descent from Adam
- 2) **Representative (Federal) View** -- Adam acted as our representative

Regardless of whether we view Adam primarily as our representative or as the father of our genetic makeup, etc.; we are indeed connected to him. When he sinned, it had a dramatic, unravelling effect upon all of us. In effect, after Adam sinned, what we would choose to do would be completely predictable--all of us would want to choose sin just like Adam. Therefore, because of Adam's sin, in effect we all are sinners by nature and choose to practice sin and deserve to die.

Thomas Schreiner: Murray (1977) proposes an interpretation that fits with a Reformed and Augustinian reading of the text. He claims that the words ἐφ' ᾧ should be rendered "*because*,"

supporting the Augustinian case on different grounds grammatically and exegetically. Taking ἐφ' ᾧ as causal, he understands Paul to say that “*death spread to all because all sinned*” (5:12c–d). The words “*all sinned*,” however, should not be understood to say that all sinned personally and individually. When Paul says “*all sinned*,” he means that **all sinned in Adam**. Death spread to all people without exception because everyone sinned in Adam. Adam’s sin was their sin, and Adam is their **covenant or federal head**. . .

The fundamental weakness of Murray’s interpretation of 5:12–14 needs to be unpacked. His understanding of 5:12–14 rests on the premise that the sins of those who lived between Adam and Moses were not counted against them (5:13). They died because of Adam’s sin, not their own. However, such a reading doesn’t fit the narrative in Genesis (chaps. 6–9), and Paul was well acquainted with these stories. The prime example is the generation of the flood. The entire generation, apart from Noah and his family, perished in the flood. Those destroyed by the flood were judged, condemned, and died for their own sin. We have no indication that the sin assessed against them was Adam’s sin. The same point could be made about the judgment at Babel (Gen. 11:1–9; cf. here Feuillet 1970: 486; Laato 1991: 134). . .

When Paul says that sin is not counted against those who have no law (5:13), he doesn’t mean that those who don’t have the law are judged only on the basis of Adam’s sin. Those without the law clearly perish because they violate moral norms. Murray’s interpretation doesn’t fit with what Paul teaches elsewhere or with what we find in the OT. . .

Paul affirms that the sin of individuals leads to death, but against Pelagius he also teaches that individuals come into the world condemned and spiritually dead because of Adam’s sin. The latter part of 5:12 must not be separated from the first part of the verse. Sin and death entered into the world through Adam, and hence people sin and die because of both Adam’s sin and their own sin, though the sin of Adam is fundamental and typological. Five times in 5:15–19 Paul emphasizes that death and condemnation are the portion of all human beings because of Adam’s one sin. It simply won’t work exegetically to limit death to personal and individual sin when Paul communicates repeatedly and forcefully that human beings experience death and judgment because of Adam’s sin. The parallel between Adam and Christ rules out a one-dimensional solution (cf. Calvin 1960: 112).

B. (:13-14a) Sin and Death Reigned before the Mosaic Law

1. (:13) Sin Was in the World

*“for until the Law sin was in the world;
but sin is not imputed when there is no law.”*

2. (:14a) Death Reigned

*“Nevertheless death reigned from Adam until Moses,
even over those who had not sinned in the likeness of the offense of Adam,”*

The illustration that proves the point -- What was the situation before the law from the time period from Adam until Moses? (when there was no clear, direct, outward command from God; Eve's sin was not as significant because she derived from man and because she did not get the command directly from God.)

Frank Thielman: Paul's primary point, however, is that in the period when people only had an internal and somewhat vague sense of what God required (2:14–15), and before anyone had been “entrusted with the oracles of God” (3:2), they still sinned against God and received the penalty of death.

Thomas Schreiner: So, when Paul says that their sins were not reckoned or counted against them, he isn't teaching that their sins were not counted against them in any sense. They were punished for their sins, since they experienced the reign of death because of their sins. Paul's point is that their sins, though still punishable by death, were not technically counted against them **in the same way** as sin was counted against Adam. In **Rom. 5:12–14** Paul considers both the sin of Adam and the sin of those who lived between the time of Adam and Moses. In both cases sin led to death, but Adam played a fundamental and typological role that those who followed him did not play, and hence Adam's sin and death are the fountainhead for the sin and death that ensued. As **A. Hultgren** (2011: 226; cf. also 227) says, Adam is “positioned as the head of humanity.” Adam and Christ are the typological heads, and their fundamental role is explicated in the following verses.

In **Rom. 5:13–14**, then, we see that the power of death is so great that it exercises its dominion over people even if no law exists. In addition, violating a commandment revealed by God **increases the seriousness of sin** in the sense that the sin is now more defiant and rebellious in character (**Calvin** 1960: 119; **Westerholm** 1988: 183–84). This point accords with the Pauline conception that sin increases (5:20) and takes on a sharper profile (7:7–11) through the law.

C. (:14b) Adam = Type of Christ in Terms of Federal Headship

“who is a type of Him who was to come.”

Frank Thielman: Adam is merely a “type” of Christ, corresponding to him only in the sense that both were human and what both did affected all humanity.

II. (:15-17) THE GRACIOUS GIFT -- CHRIST'S GRACE HAS GREATER EFFECTS UPON US – THE RESULTING RIGHTEOUSNESS AND LIFE FROM OUR SOLIDARITY WITH CHRIST ARE EVEN MORE CERTAIN IN A MUCH DIFFERENT SENSE

A. (:15) Superior Effects of the Gracious Gift

1. Christ's Gift Different from Adam's Transgression

“But the free gift is not like the transgression.”

2. Different in What Respect? Life-Giving Rather than Death Damning

a. Adam's Transgression Damned Many to Death

“For if by the transgression of the one the many died,”

b. Christ's Gift Brought Life to Many

“much more did the grace of God and the gift by the grace of the one Man, Jesus Christ, abound to the many.”

Frank Thielman: The first difference is a contrast of certainties: if it is certain that Adam brought sin and death into the world, then it is much more certain that God has brought justification and redemption to the world through Jesus Christ (5:15). . .

Lying beneath this premise is Paul's conviction that God is not only just but that he is especially merciful (cf. 5:6–8). God was just in punishing Adam and his progeny for their sin, but since he is *"merciful and gracious, slow to anger, and abounding in steadfast love and faithfulness"* (Exod 34:6; cf. Rom 9:15), it is even more certain that he has been gracious to believers through the redemptive death of Jesus Christ. If he, as a gracious God, punished Adam's sinful misstep with death, believers can rest assured that God's free gift of Christ's sacrificial death has reconciled them to God (5:9–10).

Thomas Schreiner: The grace of Christ is not merely undeserved favor. It is also a power that reverses the consequences of Adam's sin. It overflows to such an extent that it triumphs over what Adam introduced into the world. As a result, believers, who have received this grace, can be certain that sin and death will never triumph over them. They (sin and death) have been decisively defeated by Jesus Christ.

S. Lewis Johnson: Now here in this passage, that *"all"* or *"many"* in this case is **limited by the context**. When he says, *"The grace which is by one man, Jesus Christ, hath abounded unto the many,"* that is limited by the statement in **verse 17**, *"For if by the one man's offense death reigned by one, much more they who receive abundance of grace and of the gift of righteousness shall reign in life by One, Jesus Christ."* So the many, is the many who received the grace of God in the Lord Jesus Christ. So, the offense has abounded unto the many, *"all,"* in death, but the grace of God has abounded to **the many who receive** the abundant grace of God that is in the Lord Jesus Christ.

B. (:16) Superior Effects of the Gracious Gift

1. Christ's Gift Different from Adam's Transgression

"And the gift is not like that which came through the one who sinned;"

2. Different in What Respect? Justification Rather than Condemnation

a. Adam's Transgression Resulted in Condemnation

"for on the one hand the judgment arose from one transgression resulting in condemnation,"

b. Christ's Gift Resulted in Justification

"but on the other hand the free gift arose from many transgressions resulting in justification."

Frank Thielman: The second statement of difference contrasts Adam's ability to bring disaster on all humanity through a single sinful blunder and God's ability to bring lavish blessing to humanity despite the countless sins he had to overcome in order to do this (5:16).

C. (:17) Summary: Superior Effects of the Gracious Gift

1. Adam's Transgression Resulted in Death Reigning

*“For if by the transgression of the one,
death reigned through the one,”*

What does it mean for something to reign or rule?

Illustration: smallpox reigned over early settlers until vaccine discovered.

Thomas Schreiner: What is the evidence that all are condemned through Adam and all are righteous in Christ? The evidence for universal condemnation is the reign of death over all people in Adam, and the evidence for the gift of righteousness is the reigning in life that becomes a reality through Jesus Christ. The reign of death was inaugurated through Adam's transgression. Adam was intended to rule the world for God, but by virtue of his sin both he and all his descendants were alienated from God, and instead of Adam ruling the world, death ruled over him. Here Paul assumes that the human race is a unity, rejecting any notion that people are separate from Adam. They enter the world spiritually dead and destined for physical death because of Adam's one sin. Clearly, Adam is the fountainhead for sin and death in the world (cf. **5:12a–b**).

2. Christ's Gift Resulted in Righteousness Reigning in Life

*“much more those who receive the abundance of grace and of the gift of
righteousness will reign in life through the One, Jesus Christ.”*

Righteousness assures us of reigning in life; no reason to fear death; we will be everything God wants us to be--not by our own efforts but by God's grace'

- Christ's Gracious Gift of Righteousness is a Surpassing Gift
- Christ's Grace must be Received

III. (:18-19) TWO DESTINIES -- OUR UNITY WITH ADAM OR CHRIST WILL DETERMINE OUR FUTURE

A. (:18) **Destiny of Condemnation vs. Justification**

1. Destiny of Condemnation through Adam

*“So then as through one transgression
there resulted condemnation to all men,”*

2. Destiny of Justification through Christ

*“even so through one act of righteousness
there resulted justification of life to all men.”*

Frank Thielman: Paul's use of “all” in both sides of the comparison does not mean that every human being will experience the life that comes from justification just as every human being is subject to sin and death. This is clear from the role that human faith plays in Paul's description of the gospel throughout **1:16 – 5:11**, most recently in **5:1–2** where faith is the necessary condition of justification and access to God's grace.

What, then, did Paul mean when he described Jesus Christ's righteous act as bringing life-giving justification to **all** human beings? He meant that God had graciously offered the benefits of Christ's righteous act to every human being in the gospel. As Calvin put it, "Paul makes grace common to all men, not because it in fact extends to all, but because it is offered to all."

B. (:19) Destiny of Sin vs. Righteousness

1. Destiny of Sin through Adam

"For as through the one man's disobedience the many were made sinners,"

2. Destiny of Righteousness through Christ

"even so through the obedience of the One the many will be made righteous."

Illustration: row of dominoes -- first one falls and that leads to all the others falling in predictable fashion;
in reverse video, if the last falled domino were to rise upright, so would all the others in that same row.

IV. (:20-21) SURPASSING GRACE -- THE PURPOSE OF GOD'S LAW IS TO MAGNIFY OUR SIN AND HIS SURPASSING GRACE

A. (:20a) The Law Increases Sin

"And the Law came in that the transgression might increase;"

Magnify = make sin and grace more abundant and more clear

Why did God give the law (His commandments) if we are unable to keep it?

- To provoke our sinful nature to evidence itself more specifically and clearly in defined acts of transgression; to make our sinfulness more abundant and more clear
- To provide the opportunity to demonstrate God's surpassing, abundant, victorious grace -- Grace Triumphs Over Sin

(The Christian's freedom from the dominion of sin, the law and death are developed in **chaps. 6-8**)

Grant Osborne: The law was added (**5:20**) to help people see their sinfulness, to show them the seriousness of their offenses, and to drive them to God for mercy and pardon. This was true in Moses' day and in Paul's day, and it is still true today. Sin is a deep rupture between who we are and who we were created to be. The law points out our sin and places the responsibility for it squarely on our shoulders, but it offers no remedy.

B. (:20b-21) Increased Sin Highlights Surpassing Grace

"but where sin increased, grace abounded all the more, 21 that, as sin reigned in death,

even so grace might reign through righteousness to eternal life through Jesus Christ our Lord.”

Frank Thielman: Immediately after the main verb, however, Paul returns to God’s purposes in giving the law. The effect that the toxic mixture of sin and law had on rebellious human beings did not lie outside the gracious purposes of God. God intended that the law should increase the trespass so that, precisely in this context, his grace might “superabound” (cf. **5:6–8, 10; Col 2:14–15**).

Thomas Schreiner: The election of the Jews as God’s people was designed to reverse the impact of Adam’s sin, and most Jews believed that the law’s role was to restrain the sin that Adam introduced into the world. By contrast, Paul maintains that God’s intention in giving the law was to increase sin, and to increase it particularly in Israel. The piling up of sin in Israel via the law doesn’t indicate malevolence in God toward his people. It shows that the problem introduced into the world through Adam is not remedied through the law. These verses anticipate **Rom. 9–11**. Sin reached its climax in Israel so that God’s grace would be discerned more clearly in his mercy both to gentiles and to Israel. The end of the story, therefore, is not the triumph of sin. The story ends with the victory accomplished by grace, a grace that fulfills God’s righteousness and promises through the last Adam, Jesus the Messiah.

Grant Osborne: No matter how much people sin, God’s grace is greater. There are occasions of insight in life when people realize in a new way the reality of their sinfulness. Sometimes, reflecting on the commandments reminds us of our tendency to fall. Our consciences also flare with guilt from time to time. At other times, a loving friend may confront us with a sinful act or habit. When our awareness of sin increases, we need to ask God to help us see that his grace is always greater in its capacity to forgive than our capacity to sin.

* * * * *

DEVOTIONAL QUESTIONS:

- 1) How does this concept of federal headship not undermine individual accountability for sin?
- 2) If Adam and Eve were not real people and the biblical account of Creation and the Fall is not accepted as the historical time reference for the introduction of sin and death into this world, how is our Christian theology impacted?
- 3) Is righteousness or sin reigning in your life right now?
- 4) How should you counsel people who despair that their sins have rendered them beyond God’s power to save?

* * * * *

QUOTES FOR REFLECTION:

Frank Thielman: Christ's Obedience Overwhelms the Effects of Adam's Disobedience (5:12–21)

1. Adam's Sinful Misstep (5:12–14)
2. The Differences between Adam and Christ (5:15–17)
 - a. Sin and death through Adam; justification and redemption through Christ (5:15)
 - b. Multiplied disaster through Adam; lavish blessing out of disaster through Christ (5:16)
 - c. A summary of 5:14–16 (5:17)
3. The One Similarity between Adam and Christ, and a Digression on the Law's Role in Salvation History (5:18–21)

Thomas Schreiner: The structure of the text can be divided into three sections. First, **verses 12–14** chart the entrance of sin and death into the world through Adam. Paul argues that the death introduced into the world through Adam spread to all people, and the consequence or result of this death was the individual sin of every human being. If every person has sinned since Adam, Paul must answer how those who lived in the era when the law was not revealed sinned (**vv. 13–14**). If there is no transgression apart from the law (**4:15**), then it would seem to follow that those who lived in the interval between Adam and Moses could not die for their own sin, since the law was not in place. Paul argues, however, that the reign of death over all reveals the existence of sin during this period of time, even though those people's sin was distinct from Adam's in that the latter violated a revealed commandment.

At the end of **verse 14** Paul returns to his main point, which is a comparison of the work of Adam with that of Christ. The succeeding verses indicate that the correspondence between Adam and Christ should be understood in terms of a contrast between Adam and Christ. Five times the outcome of Adam's trespass is hammered home: "*many died*" because of his sin (**v. 15**); his sin brought "*condemnation*" to all (**v. 16**); "*death reigned*" over all human beings (**v. 17**); all people were condemned because of his one trespass (**v. 18**); and by virtue of his sin "*many were made sinners*" (**v. 19**). Still, the work of Christ is even greater because it has conquered and reversed the consequences of Adam's sin: Christ's grace and gift abounded for many (**v. 15**); his grace brought "*justification*" where Adam introduced "*condemnation*" (**v. 16**); instead of death reigning, believers now "*reign in life*" by virtue of the grace of Jesus Christ (**v. 17**); the righteous act of Jesus Christ brought justification "*that leads to life*" for all (**v. 18**); and through Christ's obedience the many are now "*made righteous*" (**v. 19**).

The third section of the text introduces the role of the law in history (**vv. 20–21**). To depict human history in terms of Adam and Christ leaves out the giving of the law on Mount Sinai, one of the most significant events in history. The standard Jewish view was that the law was given to restrain sin. Paul's perspective represents a stunning departure from such a theology, since he maintains that sin increased with the onset of the law. The advance of sin doesn't quench the hope of believers, however, because grace conquers where sin ruled. Whereas sin once reigned in the dominion of death, now **grace reigns** through the work of Jesus Christ the Lord.

S. Lewis Johnson: So God actually has operated in such a way that he has been most beneficent in his dealings with us. He had one representative to act for men. He put him in an ideal environment, a sinless environment. He gave him every incentive to obey. He allowed him the maximum freedom and gave him a minimum, so far as forbidding action is concerned. He could eat of every tree which was in the midst of the garden, but of one tree he was unable to eat. In addition, he informed Adam that he was a federal head and furthermore, that his actions would affect his destiny. That is clear because the threats that God imposed were threats that were carried out upon Adam's destiny. He acted as a representative man, and so he acted with great incentive to obey, more incentive than any one individual would ever have had. And so consequently, God in his infinite wisdom and goodness has acted in a most beneficent way toward men.

He has conceived this plan by which all men act in their representative Adam, in order to prepare the way for men acting in a second representative the Lord Jesus Christ. So, just as men have fallen in Adam, apart from any act of disobedience on their part, so in Christ they may be raised to a status of justification of life apart from any act of theirs or apart from any merit of theirs. It is God's gracious way of dealing with men. And I can only say, in the light of pondering it that I cannot imagine any other scheme by which God may have dealt in a more beneficent way. Upholding his law, demonstrating his righteousness and holiness and justice and at the same time manifesting his grace and loving kindness to us. I must say, I love this plan that God has devised. It is the most fruitful plan for sinners.

Now that's the first thing though that happened when Adam sinned. His sin was imputed to each member of the race. Everybody is guilty, and incidentally, whether we like it or not, that is the state of things. And even if we did not like the plan or found it very confusing, we should, in wisdom, say, "Well that's the way he's done it. I may not understand it, and I may not really like it, but I'm going to submit to it because it is the plan of a holy sovereign God, and I had better submit to it." And you'll find that when you submit to the plan of God that, ultimately, the understanding will come and then you'll rejoice in the way that God has dealt with you.

The second thing that happened when Adam sinned was that his nature became corrupted, and he has given us a corrupt nature as a result. That corrupt nature, called by theologians in the special sense "original sin," has been passed on to all men. We are born in sin. As the apostle says, "*We are by nature children of wrath.*" And if you have any doubt about it, just read your newspapers, and you'll see that we are children of wrath.

And the third thing that follows as a result of Adam's sin is that we are unable to respond savingly to the Word of God. Naturally, we do not respond to Scripture. If you were to take a look around you at the race, as a whole, you will see that this is carried out in the history of men. Men do not respond to the word of God. They constantly rebel against it. Governments rebel against the word of God, too. Putting it in the words of the apostle in this same epistle, he says in the 8th chapter, the 7th and 8th verses, "*The mind of the flesh is enmity against God; it is not subject to the law of God, neither indeed can be.*" So in the nature with which we are born, we cannot be subject to the word of God. So then, "*they that are in the flesh cannot please God.*" That's why we cannot, of ourselves, believe in God because we are in flesh, "*They that are in the flesh cannot believe God.*" There must be an operation of the Holy Spirit by which we are taken

out of the flesh in order that we may believe. So that as a result of the regenerating work of the spirit or the efficacious grace of the spirit, whatever we call it is insignificant, we are brought to faith by the Lord God in grace.

And the final, the fourth effect of the sin of Adam is that all men are destined for eternal punishment. “*Dust thou art unto dust thou shalt return,*” God said to Adam. He said, “*In the day that thou eatest thereof thou shalt surely die.*” **He died spiritually.** He was told that as a result of that he would die physically, and if there is no deliverance from our spiritual death, that death is prolonged into eternity. And we suffer the second death, or eternal death, in the lake of fire.

And yet at the same time, Paul says Adam is a type of Christ. Well clearly, Adam must be a type of Christ, primarily, by **contrast**, not by comparison. For Christ is not the source of death, he’s the source of life, justification of life. The thing that the apostle wants to use to clarify the relationship between the two Adams is this master idea of **the unity of the many in one. All men stand in their representative Adam. All the people of God stand in their representative Jesus Christ.** The act of Adam affects his posterity. The act of the Lord Jesus Christ on the cross affects those who are the people of God. In that way there is a beautiful example of the work of the last Adam in the work of the first, for his work affects his covenanted people for whom he stands, just as in the case of Jesus Christ. As **Augustine** said, “God has dealt with two people. He has dealt with Adam, and he has dealt with Christ. And the rest of us fall into the relationship that he has set forth in the word.”

Michael Gorman: Christ vs. Adam

	ADAM’S DEED	CONSEQUENCES	CHRIST’S DEED	CONSEQUENCES
15	trespass	many died	(free/gracious) gift, grace	the grace of God and the free gift abounded/overflow/have overflowed for the many
16	sin/sinning, one trespass	many trespasses, judgment, condemnation	(free) gift	justification/acquittal
17	trespass/transgression	Death exercised dominion/came to reign/reigned	abundance/abundant provision of grace, free gift of righteousness/justification	exercise dominion in life/(come to) reign in life
18	trespass	condemnation for all	act of righteousness	righteousness/justification/acquittal and life for all ²⁷
19	disobedience	many were made sinners	obedience ²⁸	many will be made righteous

Leedy Greek NT Diagrams:

Rom 5:12-14

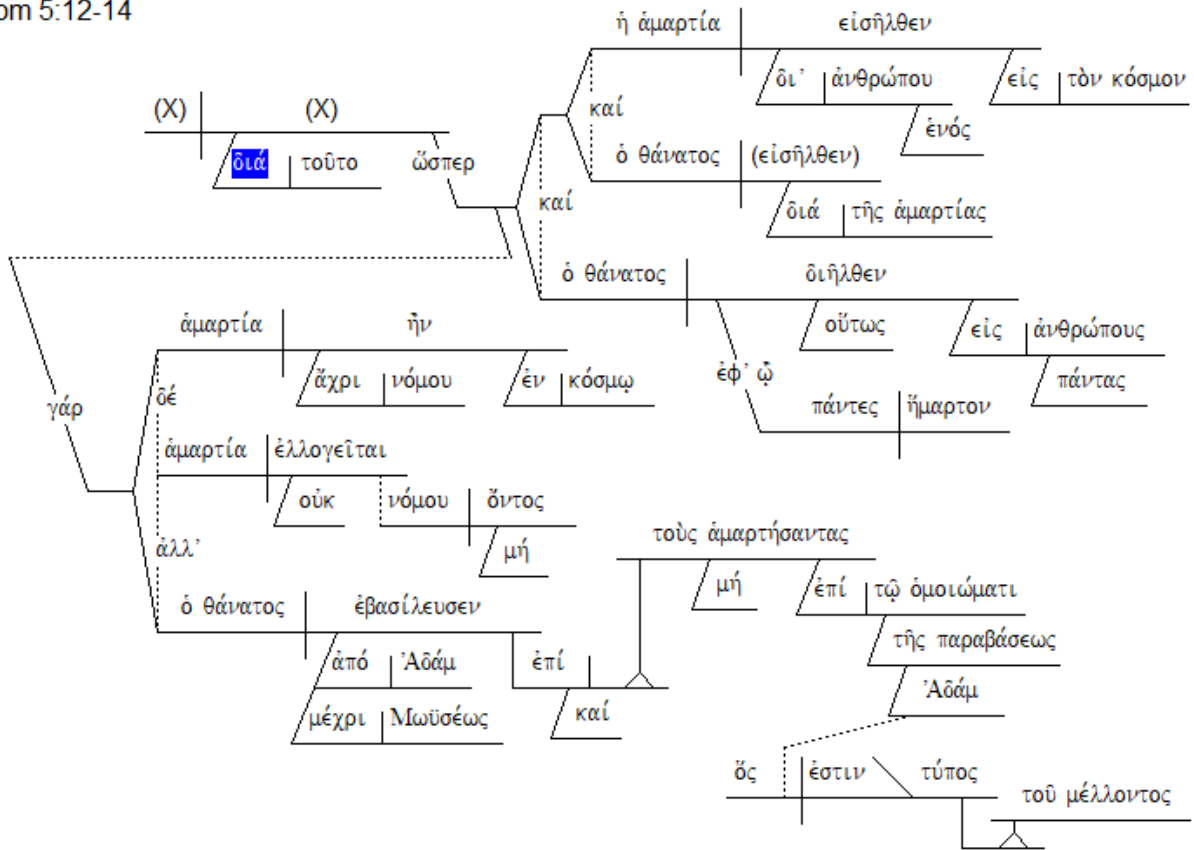

Rom 5:15

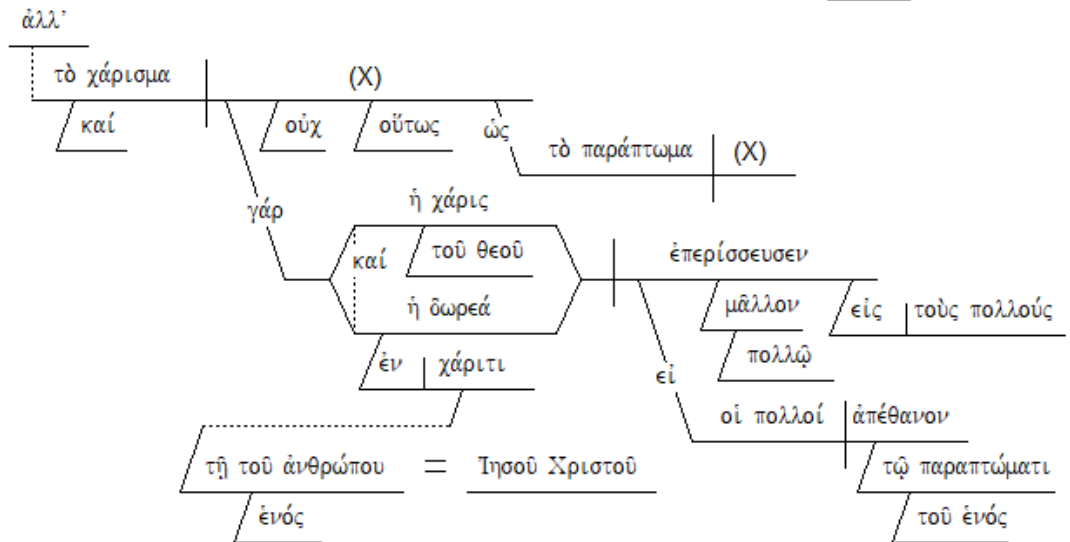

Rom 5:16

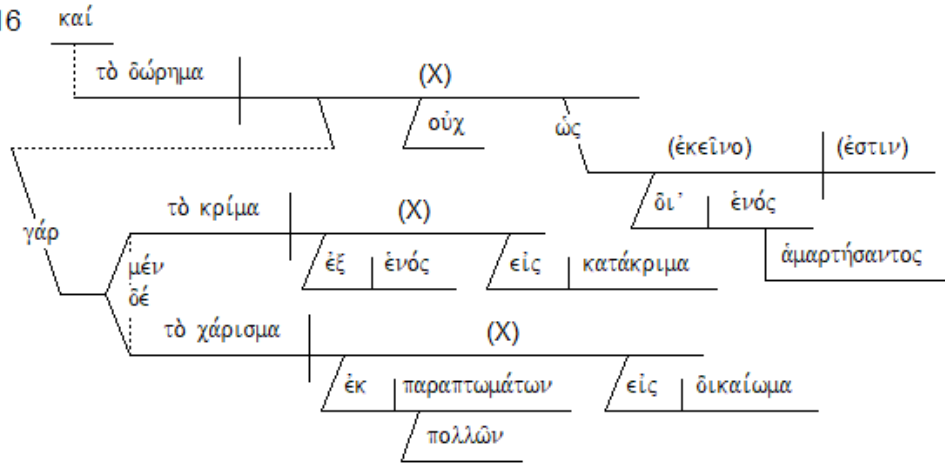

Rom 5:17

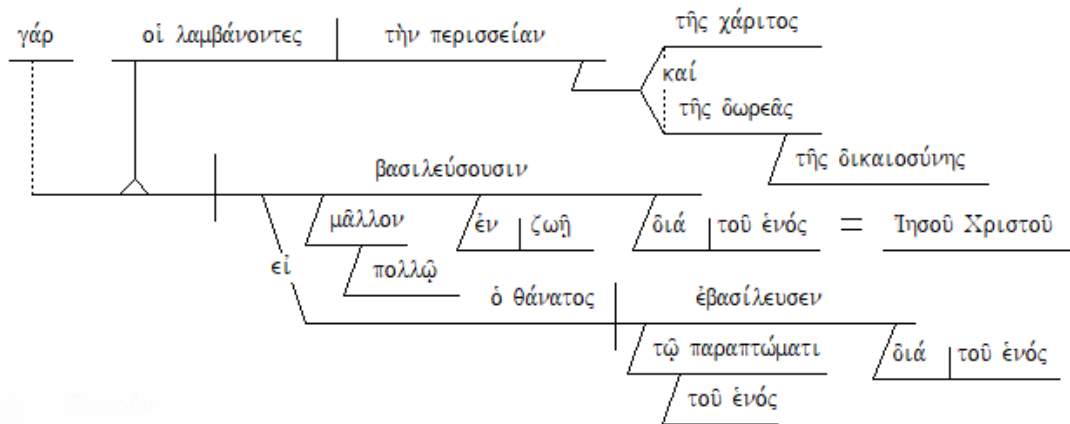

Rom 5:18-19

ἀρα οὖν

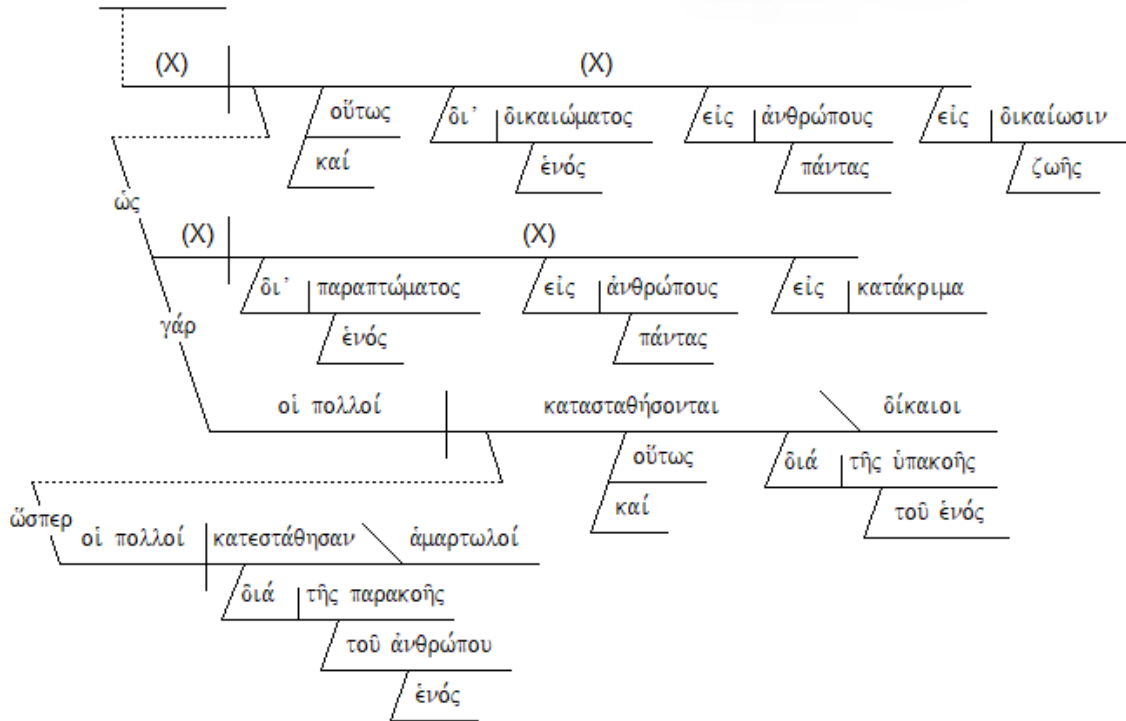

Rom 5:20-21

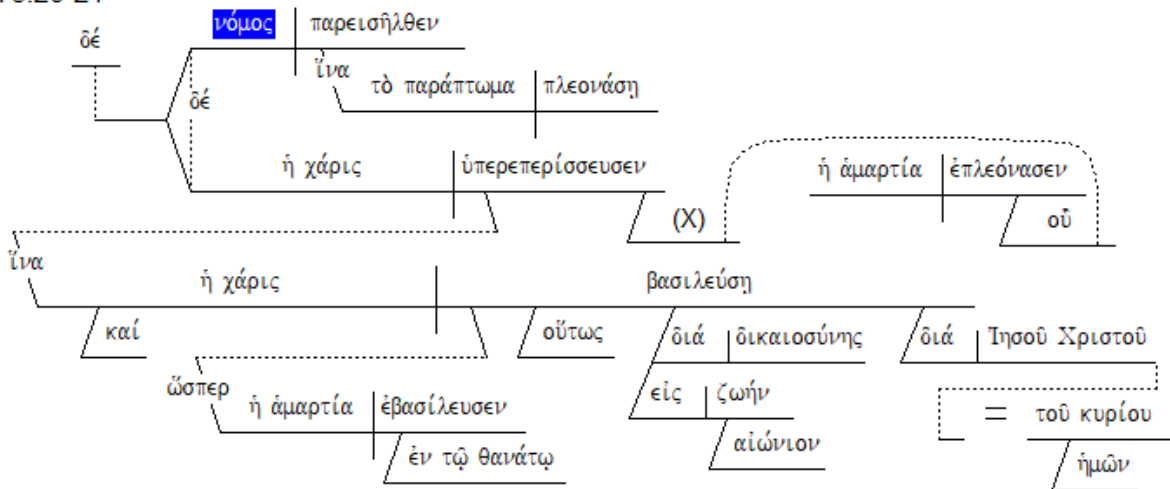

Frank Thielman:

12a	Result	Because of this, just as	sin entered the world	through	one human being, and
b			death	through sin, and	
c		so	death advanced to		all human beings,
d	Result		whereupon all sinned—.		
13a	Assertion	For until the law	sin was in the world,		
b			but sin is not invoiced	when there is no law.	
14a	Contra-expectation	Yet	death reigned from Adam until Moses,		
b			even over those who had not sinned		
c	Manner			in the likeness of the transgression of Adam	
d	Description			who is a type of the coming one.	
15a	Contrast	Yet	the trespass is not like the free gift,		
b	Expansion	for	if by the trespass of the one the many died,		
c	Contrast/Inference		has	the grace of God and	how much more
d	Means		the gift given by grace abounded to the many by the one human being, Jesus Christ.		
16a	Contrast	And	the gift is not like what happened through the one who sinned,		
b	Expansion	for	the judicial sentence	arose out of one deed and	brought condemnation,
c	Contrast	but	the free gift	arose in the context of many trespasses	for the purpose of justification.
17a	Expansion	For		if death reigned by the trespass	of the one person,
b	Contrast/Inference			how much more	
c	Assertion		will those ...		
d	Identification	who receive	the abundance of grace and	... reign in life	
e	Means		the gift of righteousness	through the one person, Jesus Christ.	
18a	Comparison	So then, as	condemnation	through the trespass of the one person	came to all human beings,
b	Inference/Means	so also		through the righteous act of the one person	
c			life-giving justification	came to all human beings.	

- 19a Expansion/
Comparison For just as through the disobedience of the one human being
the many were rendered sinners,
- b Inference/Meanings
c so also through the obedience of the one
the many will be rendered righteous.
- 20a **But the law slipped in**
b Purpose so that the trespass might increase;
- c Sphere but where sin increased,
d **grace superabounded**
- 21a Purpose/
Comparison in order that just as sin reigned in death,
so also grace might reign
b Means through righteousness
c Purpose for eternal life
d Means through Jesus Christ our Lord.

TEXT: ROMANS 6:1-11

TITLE: GRACE IS NOT LICENSE TO SIN

BIG IDEA:

OUR UNION WITH CHRIST HAS FREED US FROM THE DOMINION OF SIN TO LIVE A NEW LIFE

INTRODUCTION:

God's Grace is not a license to sin but freedom to live a new life.

The Theological Foundation and Motivation for Holy Living = Freedom from the Dominion of Sin.

Frank Thielman: God has united those who have been justified by faith with Christ's death of atonement for sin and will fully unite them in the future with the new, immortal life that he has as a result of his resurrection from the dead. Since believers now have this new identity, they should live in a way that is consistent with it. They should consider themselves delivered from the power of sin and death and alive to God. In practical terms, this means placing their capabilities not in the service of sin with its illicit cravings and injustices but in the service of God who fights for what is just.

John Murray: The transition from one phase of teaching to another at the beginning of this chapter is quite conspicuous. In **verses 12–21** of the preceding chapter the argument bearing upon justification had been brought to a climactic conclusion by instituting the parallel between Adam and Christ and on the basis of that parallel demonstrating the contrasts which the superabundance of grace brings into effective and regnant operation. The invariable combinations of sin, condemnation, and death introduced by the sin of Adam, on the one hand, and of righteousness, justification, and life emanating from the grace of God and realized through the mediation of Christ, on the other, have been set forth by way of analogy and contrast as the ruling conceptions in terms of which we are to interpret God's dealings with men. Having brought the basic thesis of the epistle to this climactic conclusion the apostle is now prepared to unfold other elements of that gospel which is the power of God unto salvation. To speak in general terms, **chapter 6** deals with **sanctification** as the preceding chapters had dealt with **justification**. We are not to suppose, however, that this transition means that sanctification can be divorced either in fact or in the development of its meaning from the justification on which it rests and with which it is inseparably connected. This is evident from the reiterated references to justification in the subsequent chapters and from the way in which sanctification no less than justification springs from the efficacy of Christ's death and the virtue of his resurrection. If the **mediation of Christ is always in the forefront** in justification it is likewise in sanctification.

Michael Bird: Vital for understanding the argument of **Romans 6** is what Paul means by "*union with Christ*." According to **Constantine Campbell's** recent landmark study, Paul's Christ-language in relation to believers — in Christ, with Christ, into Christ, etc. — is all about union, participation, identification, and incorporation into the Messiah. Paul expounds the state

of our union with Christ in terms of shifting our allegiances, reshaping our identities, altering our desires, and reconfiguring our obligations, all in light of our baptism into the Messiah's death and resurrection. As **Robert Tannehill** argues, union with Christ in **Romans 6**, at its most basic level, is about our **emancipation from sin's dominion** and our entrance into the new age in Christ. In **Romans 6**, Paul treats union with Christ as bringing in a new exodus that releases believers from slavery to sin and puts them in service to God. . .

Paul constructs this passage around a series of exhortations that are often diatribal in form, full of comparisons, replete with rhetorical questions, and make manifold injunctions. He begins his train of thought by:

- (1) espousing the incompatibility between sin and grace (vv. 1 – 2), and
- (2) asserting that dying and rising with Christ mean freedom from sin (vv. 3 – 7);
- (3) this necessitates believers reckoning themselves to be dead to sin (vv. 8 – 11),
- (4) because believers are not under the jurisdiction of the law, but under the reign of grace (vv. 12 – 14).

I. (:1-2) PRINCIPLE OF GRACE RAISES AN OBVIOUS SHOCKING QUESTION

A. (:1) Introduction of the Obvious Shocking Question

“What shall we say then? Are we to continue in sin that grace might increase?”

Frank Thielman: If the Mosaic law cannot form the basis for breaking the power of sin in the believer's life (5:20), then surely—with the law out of the picture—the **believer has no basis for ethical behavior**. Paul poses as a Christian interlocutor asking a hostile question in order to move the argument forward (cf. 6:15; 7:7; 9:14).

Thomas Schreiner: Paul doesn't address any opponents specifically; the question emerges in the course of his argument. Nonetheless, the question arises because unbelieving Jews (or perhaps Jewish Christians) had often raised this objection to Paul's gospel in the course of his ministry. The rhetorical question is included because it reflects a common complaint voiced against Paul's gospel. The objection Paul handles here is an integral part of his argument and doesn't represent a digression; he addresses the issue because his adversaries had often protested that his gospel led to **libertinism**.

B. (:2) Immediate Reaction to the Absurdity of the Shocking Question

1. Immediate Emotional Reaction

“May it never be!”

Frank Thielman: Paul rejects the absurdity implied in the rhetorical question with his characteristic expression, *“Certainly not!”* This expression usually opens the way to the topic Paul wants to discuss, in this case the movement of believers out of the sphere of sin's power and into the sphere of Christ's power.

Grant Osborne: Paul denies the possibility outright. The idea that someone would claim to believe the gospel while planning to continue in sin is preposterous to Paul. He knew people

would think that way and would be wrong. The point of the gospel was not to find an excuse for sin, but to give freedom from sin.

David Thompson: Since we have been declared righteous, how could we ever want to go on sinning? God has an abhorrence for sin and the more we are developing in His grace the more we too will have an abhorrence for sin. God's grace is never to be a motive for continual sin. If we are presenting the grace of God properly, the possible argument of continuing in sin is potentially there.

2. Immediate Logical Reaction

"How shall we who died to sin still live in it?"

Looking at remaining in the state of sin in all that we were in our solidarity with Adam.

Frank Thielman: Here in **Romans 6:2**, then, it is likely that the believer's death to sin is a death to a self-centered way of life, a death made possible by God's love, displayed in the atoning death of Christ (**5:6, 8**).

If this is correct, then the meaning of the preposition "in" (ἐν) here becomes clear. Believers are no longer living **in the sphere of sin**, that is, in its power because Christ, through his atoning death, has delivered them from sin's overwhelming power (cf. **Eph 2:1-6; Col 3:3**).

John Murray: Death and life cannot coexist; we cannot be dead and living with respect to the same thing at the same time.

II. (:3-4) UNION WITH CHRIST IN BAPTISM PROVES THAT WE HAVE DIED TO THE DOMINION OF SIN IN ORDER TO LIVE A NEW LIFE

A. (:3-4a) Reality of Baptism into Christ's Death and Burial

*"Or do you not know that all of us who have been baptized into Christ Jesus have been baptized into His death?
Therefore we have been buried with Him through baptism into death,"*

What is involved in having "*died to sin*" -- Different Views:

- **Immunization** -- sin can't touch us anymore; our experience refutes this; no need for Romans to teach us to resist sin
- **Justification only** -- (**Haldane's** position) -- must be more experiential than this because of **v.18**
- **Emancipation** -- Yes, but in what sense? Sin is personified throughout this section (**chap.5 ff**) as reigning as a tyrannical power that commands us absolutely; We have been delivered once for all from the penalty of sin and from its authority to dominate our life and command us

Frank Thielman: The most natural way to take Paul's phrase, then, is less as a reference to baptism (although that must be in the background) than as a metaphorical reference to the placement of the believer, at his or her conversion, into the **sphere of Christ's power**.

Thomas Schreiner: The reference to baptism is introduced as a designation for those who are **believers in Christ**. Since unbaptized Christians were virtually nonexistent, to refer to those who were baptized is another way of describing those who are Christians, those who have put their faith in Christ. Thus Paul is saying here that all Christians have participated in the death and burial of Christ, since all Christians had received baptism. To posit that the baptism mentioned here is simply metaphorical (Dunn 1988a: 311) or baptism in the Spirit (Lloyd-Jones 1973) rather than water baptism is incorrect. D. Moo (1991: 376) rightly observes that Paul often uses the verb βαπτίζειν (*baptizein*, to baptize) to refer to water baptism (1 Cor. 1:13, 14, 15, 16 [2×], 17; 12:13; 15:29; Gal. 3:27). Roman Christians would have inevitably thought of water baptism, since it was the universal initiation rite for believers in Christ. Moreover, Paul probably loosely associated baptism with water and baptism by the Spirit (1 Cor. 12:13), since both of these **occurred at conversion**. Thus the attempt to distinguish between Spirit baptism and water baptism in the Pauline writings goes beyond what Paul himself wrote. . .

Those who are baptized belong to Christ and are united with him. . . Just as the first Adam affected all human beings by introducing sin and death, so too Christ is the **representative figure** for those who belong to him. The reference to “*our old person*” (ὁ παλαιὸς ἄνθρωπος, *ho palaios anthrōpos*) in **verse 6** refers to who we were in Adam, describing existence in the old era. And Χριστός throughout this text refers to Christ as the last Adam, the representative figure for the new humanity. To be baptized into Christ is to be joined with the last Adam, the one who brings salvation in the new age. . .

Scholars are virtually unanimous that **burial** is mentioned because it confirms and validates that death has occurred (cf. 1 Cor. 15:3–4). Burial is not mentioned to distinguish it from death as a separate entity. Death and burial together constitute a formula (cf. 1 Cor. 15:3–4) to indicate death (Fazekas 1966: 308). . .

We died with Christ in baptism in that we are united with him in his once-for-all death. Because we are incorporated into Christ, his death becomes ours. At baptism (i.e., **conversion**) the death of Christ becomes ours because we share the benefits of his death by virtue of our incorporation into him. Paul’s argument, then, is that grace cannot possibly lead believers to sin more because by dying with Christ **the power of sin has been definitively broken**.

John Murray: (1) The appeal to baptism certifies that the readers of the epistle were aware of the place and importance of baptism in the Christian profession. It was the sign and seal of membership in the body of Christ, and the apostle assumes that the believers at Rome did not call in question the necessity and privilege of this seal of their status as Christians, an index of the fact that baptism was reckoned to be a note of the Christian church. This was a tenet beyond controversy. (2) Baptism “*into Christ Jesus*” means baptism into union with Christ. To be baptized “*into Moses*” (1 Cor. 10:2) is to be baptized into the discipleship of Moses or into the participation of the privileges which the Mosaic economy entailed. To be baptized “*into the name of Paul*” (1 Cor. 1:13) is to be baptized into the discipleship of Paul, a suggestion which Paul violently rejects. To be baptized “*into the name of the Father and of the Son and of the Holy Ghost*” (Matt. 28:19) is to be baptized into the fellowship of the three persons of the Godhead.

Hence baptism into Christ signifies simply union with him and participation of all the privileges which he as Christ Jesus embodies.

B. (:4b) Reality of Baptism into Christ's Resurrection and Newness of Life

“in order that as Christ was raised from the dead through the glory of the Father, so we too might walk in newness of life.”

Frank Thielman: The term “newness” (καινότης) connotes **startling freshness**, a quality in something that makes it unlike anything else of its type. This term could describe the grandeur of Solomon's temple, the beauty of Pericles's speeches, or the strategic cleverness of the siege engine (**2 Kgs 8:53 LXX**; Plutarch, Per. 13.3; 27:3). Paul's focus, then, lies on the **qualitative** break between the believer's old life under the reign of death and sin (**Rom 5:17, 21**) and the new life of union with Christ (cf. **Rom 12:2**; **2 Cor 5:17**; **Gal 6:15**; **Eph 2:15**; **4:24**).

Thomas Schreiner: The reference to **newness** betokens an eschatological reality, for Paul speaks of a new covenant (**1 Cor. 11:25**; **2 Cor. 3:6**), a new creation (**2 Cor. 5:17**; **Gal. 6:15**), a new humanity (**Eph. 2:15**; **4:24**), and newness of the Spirit (**Rom. 7:6**).

John Murray: Death to sin is not of itself an adequate characterization of the believer's identity; it is basic and it is the fundamental premise of the argument. But death to sin is but the precondition of that life which is the final issue of grace (cf. **5:15, 17, 18, 21**). And baptism as signifying union with Christ (**vs. 3**) must mean also union with Christ in his resurrection and therefore in his resurrection life. This explains the purpose which burial with Christ is represented as fulfilling. We cannot be partakers of Christ's resurrection life unless we are partakers of his death, and death is certified and confirmed in burial.

III. (:5-10) UNION WITH CHRIST IN HIS DEATH GUARANTEES OUR NEW LIFE

A. (:5-7) Because We Have Been Freed from the Dominion of Sin

1. (:5) Union with Christ Extends to His Resurrection

“For if we have become united with Him in the likeness of His death, certainly we shall be also in the likeness of His resurrection,”

Frank Thielman: The **perfect-tense** indicative verb translated “we are” (γεγόναμεν) emphasizes the continuing effects of the past decision of Paul's readers to believe the gospel. They continue to be united to the likeness of Jesus's death in the present.

Thomas Schreiner: here Christ's resurrection as an eschatological event penetrates and affects the present lives of believers. Thus those who are baptized (i.e., converted) experience the impact of Christ's death and resurrection in their present existence. Believers are enabled to walk in newness of life because the power of Christ's resurrection has become theirs by virtue of their union with Christ. Through Christ's resurrection the power of the eschaton has entered the present evil age. This does not mean that believers have fully experienced the age to come, for they still await the resurrection of the body (**Rom. 8:10–11, 23–25**). Hence, there is significant eschatological reservation here. Nonetheless, the glorious power of the resurrection (**6:4**) has grasped those who belong to Christ, enabling them to walk in a new way.

John Murray: Grace reigns only through the mediation of Christ and this mediation is operative for us through union with him in the efficacy of his death and the virtue of his resurrection.

2. (:6) No Longer Slaves to Sin's Power

*“knowing this, that our old self was crucified with Him,
that our body of sin might be done away with,
that we should no longer be slaves to sin;”*

Frank Thielman: The “*body of sin*” (Tyndale, KJV, NASB, ESV, NET) then, is not “the sinful body” (Luther, RSV, NAB) if one takes that to mean an existence that is sinful precisely because it is embodied. It is instead the body in its **susceptibility to sin**, “the self which belonged to sin,” in the rendering of the NJB. God has “rendered” this self “powerless” for believers through their crucifixion with Christ and so broken their bondage to sin.

Thomas Schreiner: the word σῶμα (*body*) is used because the body is the means by which sin is concretely accomplished (cf. **6:12–13**). The purpose is not to say that the body is intrinsically evil or that sin exists because of physical bodies. Against this latter notion is the emphasis on Christ being raised from the dead. Rather, the body is the emblem of sin that has dominated those who are in Adam (**7:24; 8:10**). Believers have died with Christ so that the sinful body would no longer exercise mastery (**6:6**).

3. (:7) Freed from the Dominion of Sin

“for he who has died is freed from sin.”

Frank Thielman: The principle that physical death puts people beyond the reach of sin's power demonstrates the principle in effect in the union of the believer with Christ's death. This union, too, breaks sin's power over believers.

Thomas Schreiner: believers will not experience perfect deliverance from sin in this age so that they never sin at all. What has been shattered is not the presence of sin but its mastery over believers. As **Thiselton** (2016: 143) says, “Paul does not say that Christians cannot in fact sin, but that sin cannot (logical cannot) be a ruling principle for Christians.”

Paul uses a number of expressions to show that he is speaking of sin's dominion being broken instead of perfect sinlessness. As sons and daughters of Adam, we were slaves to sin, but now we are free from its tyranny (**Rom. 6:6**). Death no longer “*rules*” (κυριεύει, *kyrieuei*, v. 9) over Christ. Believers must not “*let sin reign*” (βασιλευέτω, *basileuetō*, v. 12). There is the assurance that sin “*will not rule*” (κυριεύσει, *kyrieusei*, v. 14) over those in Christ. Believers were previously “*slaves*” (δοῦλοι, *douloi*) to sin (v. 16), but now they are “*free*” from its slavery (v. 18; cf. vv. 20, 22). From all of this we can conclude that **Rom. 6** teaches that believers are not free from the presence of sin, but they are free from its power, tyranny, mastery, and dominion. The already-but-not-yet character of Paul's eschatology shows that believers have already been liberated from the mastery of sin, but they have not yet reached the eschaton. They still battle the presence of sin until the day of redemption.

John Murray: The decisive breach with the reigning power of sin is viewed after the analogy of the kind of dismissal which a judge gives when an arraigned person is justified. Sin has no further claim upon the person who is thus vindicated. This judicial aspect from which deliverance from the power of sin is to be viewed needs to be appreciated. It shows that the forensic is present not only in justification but also in that which lies at the basis of sanctification. A judgment is executed upon the power of sin in the death of Christ (cf. **John 12:31**) and deliverance from this power on the part of the believer arises from the efficacy of this judgment.

B. (:8-10) Because There Is No Possibility of Double Jeopardy

1. (:8) Our Connection with Both Christ's Death and Resurrection

"Now if we have died with Christ, we believe that we shall also live with Him,"

John Murray: Dying with Christ is assumed and the inference is drawn that we shall also live with him. Two features of this inference are worthy of note.

(1) The certitude of faith in this result is indicated in "*we believe*". It is an **article of faith**, not of conjecture, that the life of Jesus' resurrection belongs to those who have been united with Christ in his death.

(2) The future tense, "*we shall live*" does not refer exclusively to the future resurrection state but, as found above (cf. **vs. 5**), points to the certainty of participation in the resurrection life of Christ **here and now**; it is the life of **Spiritual, mystical union**. No doubt the resurrection of the body is the ultimate fruition of this union. But we may not restrict the thought to that hope.

2. (:9) Christ's Ultimate Triumph over Death

"knowing that Christ, having been raised from the dead, is never to die again; death no longer is master over Him."

Thomas Schreiner: His resurrection signaled his triumph over sin and death, and those in Christ share that victory with him. Never again will death reign over Christ, since his resurrection demonstrates that he has defeated death forever.

John Murray: This verse expresses the ground upon which the assurance of living together with Christ is entertained. There can be suspension or interruption of participation in Christ's resurrection life or reversion to death in sin no more than can the fact of Jesus' resurrection be negated or repeated. . . The **finality of the resurrection of Christ**, emphasized here in the strongest terms, certifies again the decisiveness of the breach with the power of sin which is the burden of this passage. The believer is not regarded as dying and rising with Christ again and again. Undoubtedly there is process and progression in the believer's life and this may properly be understood as progressive realization of the implications and claims of having died and risen with Christ. But the dying and rising with Christ are not viewed as process but as definitive and decisive event and can no more be construed as continuous process than can the death and resurrection of Christ himself.

3. (:10) Christ's Once-for-all Death to Sin Yielding Continual Living to God

"For the death that He died, He died to sin, once for all; but the life that He lives, He lives to God."

Thomas Schreiner: By saying that Jesus died to sin, Paul does not imply that Jesus was himself sinful. Instead, as the last Adam he voluntarily experienced death as the consequence of sin in order to break sin's dominion. Now that the twin powers of sin and death have been defeated, Christ lives his life unto God. He has been raised from the dead and lives for the glory of God. The thrust of Paul's argument, then, is that since believers are incorporated into Christ (**Thüsing** 1965: 72–75), they will certainly live together with him in resurrection power. They can be assured of this because by dying to sin Christ defeated both sin and death. His resurrection was the seal of his victory and the promise of life for believers.

John Murray: It was by his own dying that he destroyed the power of sin, and in his resurrection he entered upon a state that was not conditioned by sin. There is good reason to believe that it is this victory over sin as power that the apostle has in view when he says that Christ "*died to sin once*". And it is because Christ triumphed over the power of sin in his death that those united to him in his death die to the power of sin and become dead to sin (**vss. 2, 11**).

IV. (:11) APPLICATION: BELIEVE IT!

A. Believe You Are Dead to the Dominion of Sin

"Even so consider yourselves to be dead to sin,"

Frank Thielman: The union of believers with Christ has applied Christ's atoning death and defeat of sin to them, but their minds and hearts need constantly to attend to this truth so that they might live in a way that is consistent with it.

Grant Osborne: A New Start

Count yourselves dead to sin means that we should regard our old sinful nature as dead and unresponsive to sin. Because of our union and identification with Christ, we are no longer obligated to follow through with those old motives, desires, and goals. So let us consider ourselves to be what God has, in fact, made us. We have a new start, and the Holy Spirit will help us become what Christ has declared us to be.

John Schultz: If we count ourselves to be dead to sin and alive to God, we are not following a figment of our imagination, we are aligning our mind to reality. The words "do not let sin reign in your mortal body" imply that we have the authority to refuse sin entrance into life. We are not only under no obligation to obey our sinful tendencies, but we have been given the power in our fellowship with God to deny sin any access.

B. Believe You Are Alive to God

1. Living a New Life to God

"but alive to God"

Bob Deffinbaugh: Our identification with Christ does not end in death to sin; it extends to our participation in His resurrection to a new kind of life. Not only does sin have no claim on us, but in our union with Christ we have been raised to a newness of life. Sin no longer has dominion

over us and we now have a new kind of life, a life which is capable of manifesting the righteousness of Christ. Positionally, we are dead to sin and alive to God. Practically we dare not fall back under the dominion of sin, but must manifest a newness of life (cf. **Colossians 3:1-13**). On the basis of our position in Christ, Paul can not only cast aside any talk of continuing in sin, but can exhort us to demonstrate our position by the practice of personal righteousness. . .

2. All Accomplished Through Our Union with Christ
“in Christ Jesus.”

Right Thinking is the Theological Foundation and Motivation for Holy Living –

- not trying to **persuade** yourself that it is true; it **IS** true!

John Murray: This verse is **hortatory**. “*Reckon yourselves*” is **imperative** rather than indicative. What is commanded needs to be carefully noted. We are not commanded to become dead to sin and alive to God; these are presupposed. And it is not by reckoning these to be facts that they become facts. The force of the imperative is that we are to reckon with and appreciate the facts which already obtain by virtue of union with Christ. The expression “*dead unto sin*” implies an abiding state or condition resultant upon the once-for-all decisive event of having died to sin by union with Christ in the efficacy of his death. And the complementation of “*dead unto sin*” and “*alive unto God,*” as parallel to Christ’s death to sin and life to God (**vs. 10**), implies that the life to God is of abiding continuance just as being dead to sin is. The **security** and **permanence** of this life to God are insured by the fact that it is “*in Christ Jesus*” the life is maintained.

John Owens used to say a pastor has only 2 problems:

- persuading unbelievers they are under the dominion of sin
- persuading believers they are not under the dominion of sin

* * * * *

DEVOTIONAL QUESTIONS:

- 1) Do we ever presume against God’s grace and excuse sloppy living?
- 2) De we give enough importance to the significance of what water baptism represents?
- 3) Does this passage indicate that our physical bodies are sinful?
- 4) Did your baptism in fact unite you with Christ and result in freedom from the dominion of sin and the power of a new life?

* * * * *

QUOTES FOR REFLECTION:

R. Kent Hughes: One of the dangers of preaching salvation by grace alone is that it can be interpreted as license to do whatever one wishes. The Apostle Paul was well aware of this tendency, as we saw in **3:8** where he mentioned that some were slanderously reporting that he and his followers were saying, “*Why not do evil that good may come?*” Because of this type of misrepresentation, Paul was always on guard when he made a strong statement about grace. So when he said in **5:20b**, “*But where sin increased, grace abounded all the more,*” he knew the worst would be made of it by some. He knew that a pernicious logic would be applied: “Well, if sin brings more grace, let’s sin!”

Verses 3–14 answer the question, how do those of us who are under grace live without being characterized by sin? How are we to live lives of victory? Paul answers logically.

- First, by understanding the nature of our identification with Christ (**vv. 2–10**).
- Second, by accepting our identification with Christ as true (**v. 11**).
- Third, by yielding to the Christ with whom we are so wonderfully identified (**vv. 12, 13**).

Frank Thielman: In **6:1–14** political imagery dominates Paul’s explanation, and the movement of the believer outside the power of sin and death is his primary concern. In **6:15–23** the imagery of slavery dominates, and Paul will dwell at greater length on the existence of believers under their new masters, obedience (**6:16**), righteousness (**6:18, 19**), and God (**6:22**).

Union with Christ as the Source of Righteous Living (6:1–14)

- a. The thesis: Christians no longer live “*in*” sin (**6:1–2**)
- b. Paul explains his thesis (**6:3–11**)
 - (1) Believers are plunged into Christ’s death and new life (**6:3–10**)
 - (a) Union with Christ’s death has broken the power of sin (**6:3–7**)
 - (b) Union with Christ’s life places believers in the presence of God (**6:8–10**)
 - (2) Summary: believers are dead to sin and alive to God (**6:11**)
- c. Paul applies his thesis: believers should live in the power of God’s grace (**6:12–14**)

Michael Bird: I suggest that Paul is announcing that co-crucifixion with Christ means that believers enter a state of righteousness because God’s justifying verdict is a speech-act that begins to create the very reality it declares. Think of it this way. At a wedding ceremony, a pastor can legally declare a marriage by saying, “I now announce you husband and wife,” but he also transforms the actual relationship between the couple by his utterance and so engenders in them a new set of obligations toward each other. In the same way, God’s righteousness is so comprehensive that it simultaneously declares and effects righteousness in the believer.

Steven Cole: Are You Dead to Sin? (:1-4)

Big Idea: Our union with Christ in His death and resurrection is the foundation for separation from sin and walking in newness of life.

1. There is a logical implication to reject: Since God's response to increased sin is abundant grace, then we should sin more to get more grace (**6:1-2a**).
2. There is a spiritual fact to know and believe: In Christ we died to sin, so we cannot still live in it (**6:2b**).
3. There is a spiritual analogy to help you understand: Your baptism pictures your union with Christ in His death (**6:3-4a**).
4. There is a spiritual fact to believe and act upon: Since we are united with Christ in His glorious resurrection, we should walk in newness of life (**6:4b**).

Dead to Sin, Alive to God (:5-11)

Big Idea: Living in light of our union with Christ is the key to overcoming sin.

1. To overcome sin, know that you are totally identified with Christ in the likeness of His death (**6:5a, 6-7**).
2. To overcome sin, know that you are totally identified with Christ in the likeness of His resurrection (**6:5b, 8-10**).
3. To overcome sin, continually count as true the fact of your being dead to sin and alive to God in Christ (**6:11**).

S. Lewis Johnson: Shall We Continue in Sin? (:1-14)

Justification, someone has said, is restoration to life. **Sanctification** is restoration to health. When a person has Jesus Christ he has not only justification but he also has sanctification. He has justification as his position. He is righteous and satisfies the righteous claims of a holy God in Christ. But also he possesses ideally sanctification. But that sanctification is something that is worked out in a process in his daily life. Justification brings us from the tomb, to use another figure. Sanctification delivers us from the old clothes that characterize the life of the tomb. We think of John chapter 11 and Lazarus' resurrection, and when Lazarus came forth from the tomb at the word of Christ, it reminds us of the fact that we have life and justification through the word of the Lord Jesus Christ. But then Lazarus it was commanded that others by should loose Lazarus from his garments. And so it is necessary for a believer in Jesus Christ to put off the old threads and put on new set forth in the word of God as that characteristic of the new life in Christ. . .

And just as one is a **work of grace** so is the other a work of grace. Just as one takes place through the instrumentality of faith so does the other take place through the instrumentality of faith. Sanctification is just as much a work of grace through faith as salvation is a work of grace through faith. Often we think we are saved by grace through faith but we've got to work out our salvation for ourselves. Oh, you say that's exactly what Paul says. "*Work out your own salvation.*" Yes he does. But he adds, "*But it is God that worketh in you both to will and to do of his good pleasure.*" And furthermore in that same epistle, he said, "*Being confident of this very thing that he who hath begun a good work in you will complete it until the day of Jesus Christ.*"

Michael Gorman: Believers' Participation in the Story / Reality of the Messiah

DRAMATIC ACT	THE STORY OF MESSIAH JESUS (1 COR 15 MJG)	THE STORY OF BELIEVERS (ROM 6 MJG)
Death	The Messiah died for our sins in accordance with the Scriptures (15:3)	We ... died with respect to Sin ... all of us who have been baptized into the Messiah Jesus, into his death were baptized (6:2–3); we have been co-joined with him [<i>symphytoi gegonamen</i>] in the likeness of his death (6:5); our old self was co-crucified with him [<i>synestaurōthē</i>] (6:6); we have died with the Messiah [<i>syn Christō</i>] (6:8); dead with respect to Sin (6:11)
Burial	he was buried (15:4a)	we have been co-buried with him [<i>synetaphēmen</i>] by baptism into his death (6:4)
Resurrection	he was raised on the third day in accordance with the Scriptures (15:4b)	<i>Present (resurrection to new life):</i> just as the Messiah was raised [by God] from the dead ... so we too might walk in newness of life (6:4); alive in relation to God in the Messiah Jesus [<i>en Christō Iēsou</i>] (6:11; cf. 6:13) <i>Future (bodily resurrection):</i> we will certainly also be [co-joined with him] in [the likeness of] his resurrection (6:5); we will also co-live with [<i>syzēsomen</i>] him (6:8; cf. “eternal life” in 6:22–23)
Appearance	he appeared to Cephas, then to the twelve [... others] (15:5–9)	present yourselves to God as those who have been brought from death to life, and present your members to God as weapons of justice (6:13) ³⁵

Leedy Greek NT Diagrams:

Rom 6:1

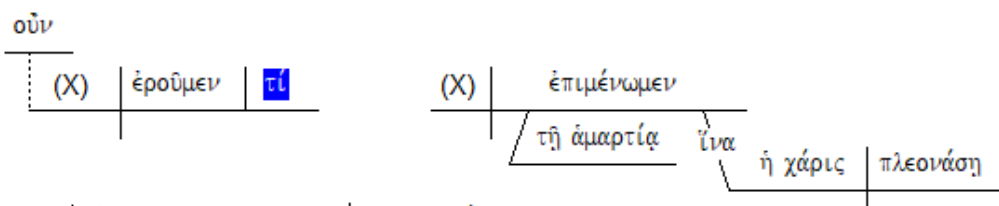

Rom 6:2

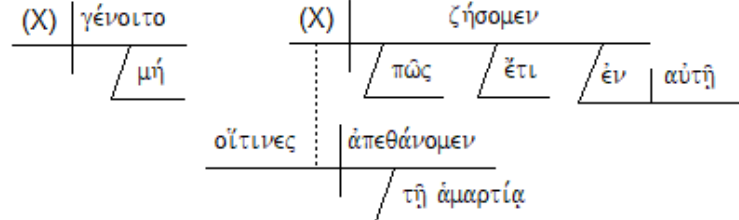

Rom 6:3

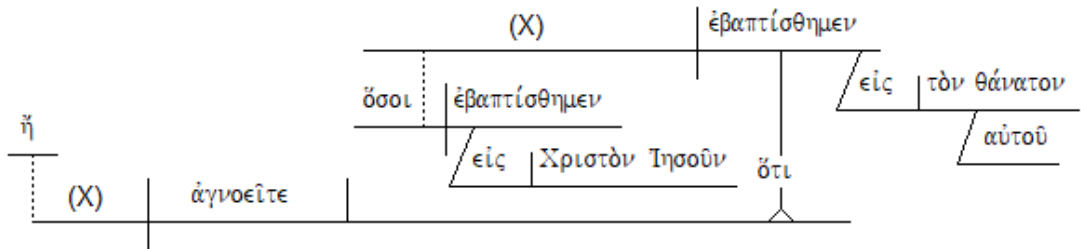

Rom 6:4

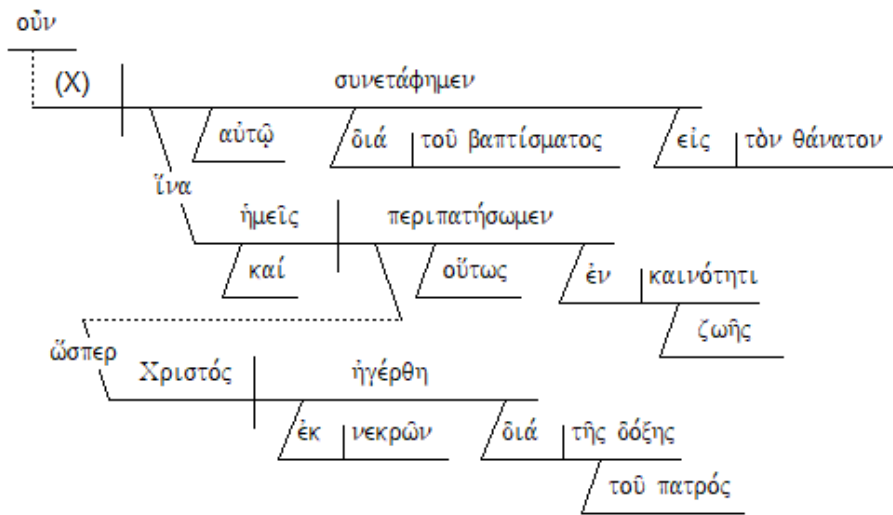

Rom 6:5-7

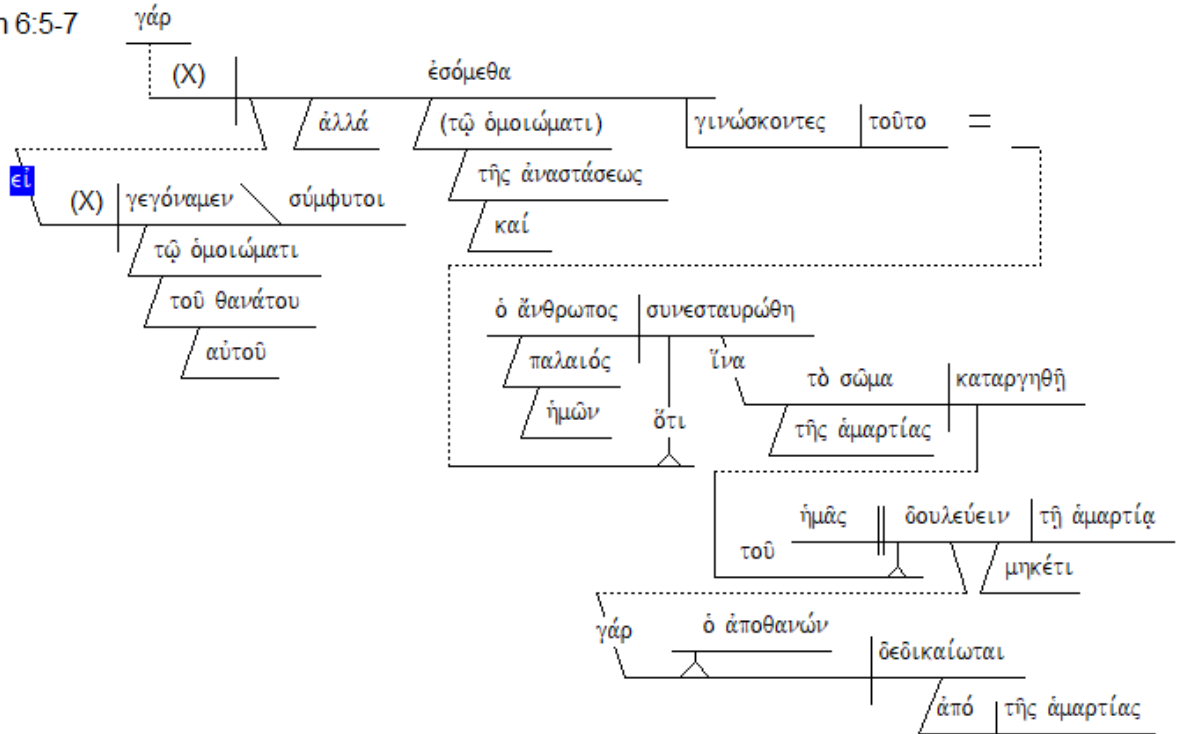

Rom 6:8-9

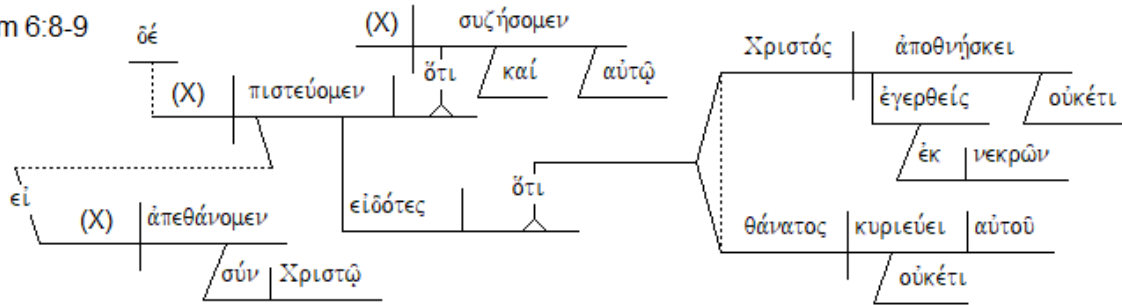

Rom 6:10

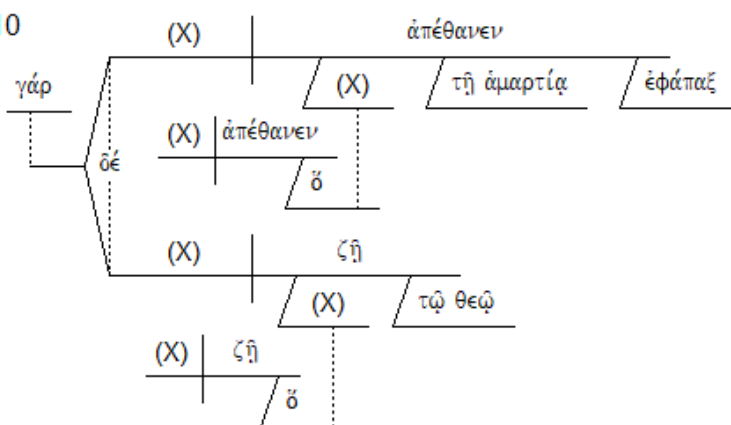

Rom 6:11

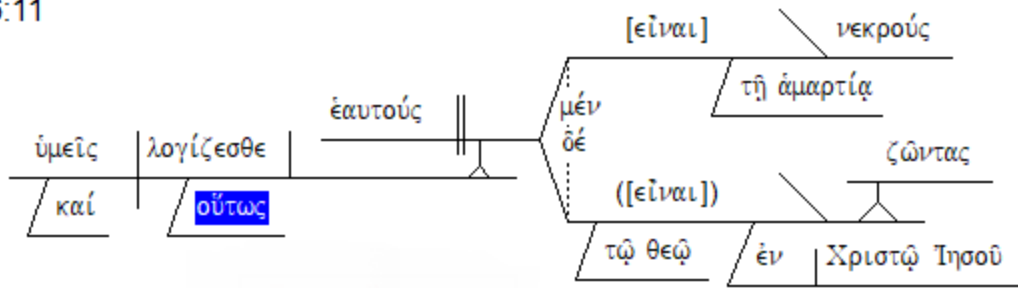

Frank Thielman:

- 1a Rhetorical Question **What, then, shall we say?**
- b Rhetorical Question **Should we remain in sin that grace might increase?**
- 2a Exclamation **Certainly not!**
- b Rhetorical Question **How will those of us who have died to sin continue to live in it still?**
- 3a Rhetorical Question **Or are you unaware**
- b Content that as many of us as were plunged into Christ Jesus
- c were plunged into his death?

- 4a Result (of 3) Therefore **we were buried**
- b Association with him
- c Means through that plunge into death
- d Purpose (for 4a) in order that just as Christ was raised from the dead through the ↗ glory of the Father,
- e Comparison (with 4b) so also we might walk in the newness of life.

- 5a Clarification (of 4c) For if we are united with the likeness of his death,
- b **we shall certainly be united** with the likeness of his resurrection.

- 6a Explanation (of 5a) For this we know, that our old man has been co-crucified
- b Purpose (of 6a) in order that the body of sin might be ↗ rendered powerless

- c Purpose (of 6b) so that we might no longer be slaves to sin.

- 7 Explanation (of 6a–b) For **the one who has died is released from sin.**

- 8a Explanation (of 5b) Now if we died together with Christ,
- b **we believe that we shall also live together with him.**
- 9a Cause (of 8b) Because we know that Christ, having been raised from the dead, no longer dies;
- b Restatement (of 9a) death no longer rules over him.

- 10 Explanation (of 9a–b) For that which he died, **he died** with respect to sin, once and for all time; but that which he lives, **he lives** to God.

- 11 Conclusion (to 2–10) **So, you too count yourselves to be dead with respect to sin but alive with respect to God in Christ Jesus.**

TEXT: ROMANS 6:12-14

TITLE: GRACE MOTIVATES GODLY LIVING – LIVE FOR GOD, NOT FOR SIN

BIG IDEA:

EXHORTATION AND MOTIVATION TO USE GOD'S GRACE TO RESIST FULFILLING THE DESIRES OF SIN AND TO OFFER OURSELVES TO GOD IN THE PURSUIT OF RIGHTEOUSNESS

INTRODUCTION:

Douglas Moo: The victory over sin that God has won for us in Christ is a victory that must be appropriated. Putting away those sins that plague us will be no automatic process, something that will happen without our cooperation. No, Paul insists, a determination of our own will is called for to turn what has happened in principle into actuality.

Michael Gorman: Paul's call for righteousness, then, is not an exhortation to a narrow form of personal holiness. It is an appeal for a radical identification with God's purposes in the world over against powers and forces that oppose God's purposes and God's ways, revealed in the Messiah, at every turn. In other words, both the ends (the goal) and the means of Christian mission must be Godlike, which means Christlike, which means cross-shaped: cruciform. Being a weapon in God's hands is essentially the same as putting on the armor of God (**Eph 6:10–18**), which Paul says later in Romans means putting on Jesus (**13:12, 14**).

John Toews: Verses 12-14 exhort Christians to resistance, to fight the rule of Sin in their moral lives. The structure is an ABBA **chiasm**:

- A do not let Sin reign, v. 12
- B do not present your members, v. 13a
- B present yourselves and your members, v. 13b
- A Sin will not reign over you, v. 14a.

I. (:12-13) THE EXHORTATION TO LIVE FOR GOD IN THE PURSUIT OF RIGHTEOUSNESS

A. (:12-13a) Negative Commands – Resist Sin

1. (:12) Don't Let Sin Be Your Master

“Therefore do not let sin reign in your mortal body that you should obey its lusts,”

Frank Thielman: Paul's “therefore” (οὖν) introduces a strong admonition on the basis of all that he has said in 6:1–11.

Resist fulfilling the desires of sin:

- 1) The Dynamic of Sin -- it is the same for everyone (like a powerful magnetic attraction)

- 2) When are we vulnerable and likely to yield?
- 3) What is involved in Resisting?
- 4) The problem comes not in having inward sinful longings, but in failing to resist so that we end up obeying sin

Thomas Schreiner: Sin is again conceived of as a power that threatens believers. Nor is the threat to sin only external. “*Desires*” (ἐπιθυμίας, *epithymiais*) for sin arise in believers, and one must deliberately resist and conquer these passions. “Against sin’s dominion, then, Paul calls for active struggle” (Keck 2005: 167). Death to sin should not be conceived in such a way that any desire for sin is no longer felt or combated.

John Murray: The force of the imperative can be understood only in the light of the relation of the indicative to the imperative. Sin does not have the dominion—this is the indicative. This indicative is not only expressly asserted in **verse 14**, it is implicit in all that the apostle has argued in the verses that precede **verse 12**. *Let not sin reign*—this is the imperative. And it flows from the indicative. It is only because sin does not reign that it can be said, “*Therefore let not sin reign*”. In other words, the presupposition of the exhortation is not that sin reigns but the opposite, that it does not reign, and it is for that reason that the exhortation can have validity and appeal. To say to the slave who has not been emancipated, “Do not behave as a slave” is to mock his enslavement. But to say the same to the slave who has been set free is the necessary appeal to put into effect the privileges and rights of his liberation. So in this case the sequence is: sin does not have the dominion; therefore do not allow it to reign. Deliverance from the dominion of sin is both the basis of and the incentive to the fulfilment of the exhortation, “*Let not sin reign*”.

2. (:13a) Don’t Allow Your Body to Engage in Sin

“and do not go on presenting the members of your body to sin as instruments of unrighteousness;”

B. (:13b) Positive Commands – Pursue Righteousness

1. Dedicate Yourselves as Regenerated Servants of God

“but present yourselves to God as those alive from the dead,”

We have been brought to life and are now able to live for God;
regenerated; new creation; breath of new life

2. Dedicate Your Body to the Pursuit of Righteousness

“and your members as instruments of righteousness to God.”

Offer ourselves to God as an instrument for doing good:

- 1) Parallel passages (**James 4:7; Rom. 12:1**)
- 2) Meaning of “offer” -- put yourself at God's disposal; make yourself available to be used for God's purpose
- 3) Nature of the offering
 - OT background
 - our entire being

- all the specific parts of your body (arms, feet, mouth)
 - other NT offerings that we are exhorted to make
- 4) Instruments of righteousness -- God's will for your life

Frank Thielman: Paul continues to explain in negative terms how his readers should act on the truth that they are dead to sin and alive to Christ, now shifting to a **military metaphor**. Despite a long English tradition of translating the term rendered here as “*weapons*” (ὄπλα) with the less specific “*instruments*” (Tyndale, KJV, RSV, NIV, ESV), “*weapons*” is almost certainly correct (**Luther**, NAB, HCSB, CEB). Not only does the verb translated “*offer*” here (παρίστημι or παριστάνω) often appear in military contexts (**Matt 26:53**; Polybius, Hist. 3.109.9), sometimes with “*weapons*” as its object (**Demosthenes**, On the Crown 175), but when Paul uses the term elsewhere he uses it in military metaphors where it clearly means “*weapons*” (**2 Cor 6:7; 10:4**, and probably **Rom 13:12**).

Paul, then, continues to view sin as a power, much like a king, that now commands an army, and he urges his readers not to place their “*members*” at the disposal of this powerful commander to use as his “*weapons of unrighteousness*.” “*Members*” (μέλη) stands parallel both to “*mortal body*” in the previous clause (in **6:12**) and to “*yourselves*” in the following clause. One’s “*mortal body*,” then, is one’s self, and the members of that body are its various abilities, whether physical, emotional, or volitional (cf. **12:4–5; 1 Cor 12:12–27; Col 3:5**). . .

The emphasis on vigilance against sin’s tendency to dominate the believer is especially appropriate after Paul has just said that believers still live in a mortal body with a tendency toward illicit cravings (**6:12**).

Transition: not saying in a simplistic sense that this is easy to do

II. (:14) THE MOTIVATION TO LIVE FOR GOD IN THE PURSUIT OF RIGHTEOUSNESS = GOD’S GRACE AS THE GOVERNING POWER OF OUR LIFE

A. Live Out Your Regenerated Reality of Freedom from Sin

“For sin shall not be master over you,”

We are no longer held in bondage to sin (**1 Cor. 10:13**)

B. Live Out the Freedom and Power of the Governing Power of Grace

“for you are not under law, but under grace.”

We are not left just to the “mercy of the law” --

God’s Law -- What it does and doesn’t do:

- 1) It only demands/commands but gives no power to obey (**Rom. 2:14-16**)
- 2) It only condemns us -- showing us how badly we’ve failed but never making us any better (**Rom. 3:19-20**)
- 3) It doesn’t restrict/restrain our fallen nature; it provokes it to sin (**Rom. 5:20**)
- 4) It can never relieve us from our bondage to sin (and death and condemnation) and free us to obey

We are now under the enabling power of God's grace:

- 1) Provides guidance and gives power to obey
- 2) No possibility of condemnation since our merit or performance is not the issue
- 3) Motivates obedience out of love and gratitude rather than stimulating rebellion and sin
- 4) Relieves us from the dominion of sin and frees us to obey

Douglas Moo: Paul is not saying that Christians have no commandments for which they are responsible. This view depends on taking “law” in a broad sense to mean any law, or “law” in general. But, as is usually the case in Paul, “law” (*nomos*) refers to the **Mosaic law**. Other interpreters think that “*under law*” means under the condemnation pronounced by the law, and “*under grace*” means the freedom from condemnation experienced by those who enjoy God’s grace. But there seems to be no good reason for adding the nuance “condemnation” here.

Most likely Paul refers generally to the fact that believers no longer live under the domination of the Mosaic law. Because we stand under the new covenant, the law of the old covenant no longer has direct control over us. The contrast between “law” and “grace,” then, is a **salvation-historical contrast**: The Mosaic law dominates the old regime from which we have been set free in Christ; grace dominates the new regime inaugurated by Jesus.

We find the same basic contrast in the famous **John 1:17** passage: “*For the law was given through Moses; grace and truth came through Jesus Christ.*” Paul has presented the Mosaic law as a power that leads to sinning (recall **Rom. 5:20**: “*The law was added so that the trespass might increase*”). In other words, for believers to be set free from the dominion of sin (**6:14a**), they need also to be set free from the dominion of the law.

Michael Bird: What Paul is getting at is that believers do not exist under the dominion of sin-death-law but live instead under the dominion of the life-righteousness-grace of God the Father and the Lord Jesus Christ. . .

If we have died and risen with Christ, certain attitudes and actions are simply incompatible with what God has done for us and in us. To use the language of Galatians, if we have been crucified with Christ, we’ve been crucified to the world (**Gal 2:19; 6:14**). We have changed jurisdictions, we have changed allegiances, and we have changed what we desire and what we fear. Believers are living out a story of paradise lost and regained, prodigals run away and prodigals returned, shifted from the dominion of darkness to the kingdom of light, and swapped the horror of hell for the hope of a new heavens and a new earth. What fundamentally shapes our ethics and ethos is not old law but new life. We find ourselves moved to obey the commandments of God, not by the old law with the threat of curses, but by new life and its power to conform us to Christ.

Grant Osborne: What does it mean that we are **not under the law**?

- We are not under the law’s demands, as were the people of the Old Testament.
- We are not under the curse implied by the impossible standard of the law (see **Galatians 3:10-14**).

- We are not under its system of requirements, the ceremonial laws that had to be meticulously kept.
- We are not under the fear of failing the just standard of the law.

* * * * *

DEVOTIONAL QUESTIONS:

- 1) Why does sin still have such a strong appeal if we are dead to sin?
- 2) Have you experienced the frustration of trying to apply these verses and yet still ending up defeated by sin? What gives?
- 3) How do the first 11 verses of Romans 6 prepare us to apply the exhortations in this paragraph?
- 4) Is it valid Christian counseling to command somebody to stop practicing some sin that has caused them problems for so many years?

* * * * *

QUOTES FOR REFLECTION:

Thomas Schreiner: The phrases ὑπὸ νόμον (*under law*) and ὑπὸ χάριτι (*hypo charin, under grace*) are best understood in a salvation-historical sense (cf. **Dunn** 1988a: 339; **D. Moo** 1991: 406). They refer to **different eras in God’s redemptive-historical plan**. The term ὑπὸ νόμον (*under law*) designates the Mosaic era as a whole, while ὑπὸ χάριτι (*under grace*) describes the new age inaugurated through the death and resurrection of Jesus Christ. The logic of **verse 14** is as follows: If you are still under the era of law, then sin will rule over you. But since you are under the age of grace, sin will not have dominion over you. Paul declares that life under the Mosaic covenant spells subjection to sin. The history of Israel confirms a redemptive-historical reading; Israel was sent into exile during the Mosaic era because it did not obey the law. The prophets themselves acknowledged that Israel had not kept the law in the Mosaic age and needed a new covenant (e.g., **Jer. 31:31–34**; cf. **Ezek. 36:26–27**). That living under the law meant living under the power of sin is also apparent from other ὑπό (*under*) phrases in Paul (see **Schreiner** 1993b: 77–81). Those who are of works of the law are “*under a curse*” (**Gal. 3:10**). **Galatians 3:21–25** suggests that those who are “*under sin*” are also those under the law, “*under the pedagogue*.” Those “*under law*” needed to be redeemed from their slavery by the death of Christ (**Gal. 4:3–5**). Those who are led by the Spirit “*are not under the law*” (**Gal. 5:18**), and thus those who are under the law are apparently not led by the Spirit but subjugated to the power of sin. **First Corinthians 9:20** is no exception, since Paul makes plain that he is “*not under law*,” although he agrees to live under the law in some situations for the salvation of fellow Jews. So too, that Jesus was “*born under law*” (**Gal. 4:4**) is the exception that proves the rule. He had to be born under the law to redeem those in slavery. . .

Paul's point is that Israel didn't keep the law as long as they were under the law (i.e., the Mosaic covenant). Now that believers are in the age of grace, they are enabled to keep the moral norms of the law by the power of the Holy Spirit (**Rom. 8:4**). This is precisely what both Jeremiah (**Jer. 31:31–34**) and Ezekiel (**11:19–20; 36:26–27**) prophesied relative to the new covenant.

Grant Osborne: How to Revolt against the Reign of Sin in Our Bodies

- Identify personal weaknesses.
- Recognize temptations.
- Confront sinful desires.
- Stay away from known sources of temptation.
- Practice self-restraint.
- Consciously invest time in good habits and service.
- Depend on grace.
- Let the peace of Christ rule in your heart!

Steven Cole: Many of you have seen the hilarious Bob Newhart routine where he is a psychologist and a woman comes for counsel because she is afraid of being buried alive in a box. (If you haven't seen it, watch it on You Tube when you need a good laugh.) Newhart's counsel for her phobia, plus several other problems, consists of two words: "Stop it!" He screams it at her over and over, "Just stop it!" She tries to bring up how her mother treated her as a child, but Newhart says, "No, we don't go there. Just stop it!"

In some ways, Paul's command to those who are struggling with life-dominating sins sounds kind of like Bob Newhart's counsel: "*Therefore do not let sin reign in your mortal body so that you obey its lusts*" (**6:12**). In other words, "**Stop it!**" Then after telling us to obey God, he gives a blanket promise (**6:14a**): "*For sin shall not be master over you ...*" It's pretty clear: "Stop sinning and obey God because sin shall not be master over you." Got it?

But as all of us know, overcoming stubborn, life-dominating sins is not as easy as just stopping it. Even though we often can see that these sins are having a destructive effect in our lives, we keep falling into them. So *how* do we stop it? How do we experience on a consistent basis the promise that sin "ain't gonna reign no more"?

Big Idea: Don't let sin reign by following your lusts, but give yourself to God to live righteously under His grace.

Let's work through these verses under four headings:

1. To apply these commands, you must understand and apply the truths of **Romans 1-6:11**.
2. Sin is a tyrant that will reign over us if we allow it to do so (**6:12-13a**).
 - A. SIN STILL HAS A STRONG APPEAL, EVEN TO THOSE WHO ARE DEAD TO SIN AND ALIVE TO GOD IN CHRIST JESUS.

B. SIN'S GOAL IS NOT TO ASSIST YOU WITH YOUR PROGRAM FOR HAPPINESS AND SUCCESS.

C. SIN SEEKS TO DOMINATE US THROUGH OUR BODIES.

D. FOR SIN TO REIGN, YOU MUST ALLOW IT TO REIGN BY GIVING YOUR BODY TO IT AS A WEAPON FOR UNRIGHTEOUSNESS.

3. In Christ, exercise your will to say no to sin and yes to God (**6:13b**).

A. WE HAVE AN ACTIVE RESPONSIBILITY TO STOP THE REIGN OF SIN.

B. VICTORY OVER SIN BEGINS BY PERSONALLY GIVING YOURSELF TO GOD.

C. VICTORY OVER SIN IS ONLY POSSIBLE FOR THOSE WHO ARE SPIRITUALLY ALIVE FROM THE DEAD.

4. God promises victory over sin to those who are not under the law but under grace (**6:14**).

David Thompson: What is the formula for victory over sin? How do we win over sin in our life? How do we beat this evil monster that plagues us and gain victory to the level that before God we will finish a believer who was a winner?

To make matters worse, religious people have come up with all kinds of ideas as to how to get victory over sin:

1. One group says deprive yourself of nice things (asceticism is key).
2. One group says isolate yourself from all sinful people, places and things.
3. One group says keep laws , make up rules and regulations - that is the key.
4. One group says don't admit sin - don't ever face it, just ignore it.

One can be aggressive, highly motivated, positive, real and brave and still never have victory over sin.

The great theologian of the first century was the Apostle Paul. He had personally been taught his theology by Jesus Christ (**Galatians 1:11-12**). When we read verses like these, it is obvious that Paul and Christ want us to defeat sin in our lives. They want us to be big winners over sin.

THE KEY TO LIVING A LIFE THAT HAS VICTORY OVER SIN IS TO CONSIDER WHAT HAS POSITIONALLY HAPPENED TO US UNDER THE GRACE OF GOD AND TO THINK PROPERLY CONCERNING SIN AND RIGHTEOUSNESS.

Now take a careful notice of this point. As long as we focus our attention on what we do - our works, our rules, our formula - we will not ever have victory over sin. However, the more we

focus our mind on the Grace of God and our position, we are beginning to think in the way that will give us victory.

KEY #1 – Consider the positional theology of the Grace of God. **6:11**

KEY #2 – Make the proper practical choices consistent with the Grace of God. **6:12-14**

Practical Choice #1 - The choice not to continually let sin reign. **6:12**

Practical Choice #2 - The choice not to continually be involved in unrighteousness. **6:13a**

Practical Choice #3 - The choice to continually be involved in that which is righteous.
6:13b

John MacArthur: And here comes a very important truth. *“Let not sin therefore reign in your mortal body.”* Would you underline that? **Your mortal body.** I think this will erase an awful lot of confusion. You know where sin wants to reign? It says in that verse. Where does it want to reign? In your, what? Body, your mortal, what does mortal mean? **Corruptive.** Is our mortal body that which will dwell eternally with God? No, that’s our glorified body. It’s this earthly, cursed, physical organism which encompasses the physical body with all of its members and organs as well as the brain and all of its functions. It is the physical body which sin seeks to rule. Now, listen very carefully to me. **Before you were saved, sin reigned not only in your body but in your soul as well.** But I believe when you were redeemed, the new creation is the soul, and sin is only left with the physical body to rule. And I say that because that’s what he says. It is a very specific term. This is not our old nature. We’re not talking about the nature, the real man, the real I inside. That was the soul, the inward man. It is not the new man, the new nature sharing residence with the old vile, sin-ruled soul. No, no, that is dead and we have a new soul, the real me, the real self. The inward man is holy and pure and set for heaven.

The **only beachhead** sin has to approach me by terminology of Paul, and granted, talking about semantics, but let’s get it right. The only beachhead is the body. You want some other terms? Our flesh, our humanness. And the word “mortal” in the dictionary, I looked it up, it means “transitory, subject to death and belonging to this world.” We are new souls. We are new creations. But sin is still left in our bodies. And that means, people, listen. If we could just get rid of these bodies, we would have instant holiness. You believe that? That’s exactly what the Bible teaches, **Romans 8:21**, look at it. *“The creation itself, also, shall be delivered from the bondage of corruption,”* and he’s talking about the physical, *“and will be set loose in the glorious liberty of the children of God.”* I mean, won’t it be great when we get rid of this part of us? *“And we know that the whole creation, that whole physical dimension, groans and has labor pains,”* and not only the whole creation, *“but ourselves who have the firstfruits of the Spirit, even we ourselves groan within ourselves, waiting for the adoption, that is the redemption of our,”* what? *“Of our body.”* That’s what we’re waiting for. **We’re waiting for a redeemed body.** We want to get rid of the one we’ve got.

Look at Philippians chapter 3 and I want you to see the consistency of the apostle in teaching this principle. **Philippians 3:20**, *“For our citizenship is in heaven.”* Now, that’s the soul. We are heavenly citizens. We’re new creations. We are partakers in the divine nature. We’re indwelt by the living Spirit of God. *“Our citizenship is in heaven, from which also we look for the Savior, the Lord Jesus Christ.”* And when He comes, what’s He going to do? Is He going to change our soul? No, He’s going to change our, what? *“Our vile body, our lowly body, the body of humiliation that it might be fashioned like His glorious body.”* That’s what we’re waiting for.

Just another passage to help you in your thinking. **First Corinthians 15:50**. A very important statement: *“Now, this I say, brethren,”* here you go, are you ready for this? *“Flesh and blood cannot inherit the Kingdom of God.”* You want to know something, folks? You can’t get into heaven in that thing you’re in right now. Now, you look at it and you think it’s great, maybe. And relatively speaking it may be a lot better than somebody else’s. You can’t get into heaven with it. Why? The end of **verse 50**, *“Because corruption doesn’t inherit incorruption.”* Well, what we going to do about that? I mean, how we going to get in? Oh, I’ll tell you how. I’ll show you a mystery. *“We’ll not all sleep, we’ll all be changed. In a moment, in the twinkling of an eye, at the last trumpet, the last incredible trumpet shall sound; the dead shall be raised incorruptible.”*

Now, when they come out of that grave, are they going to have mortal bodies? Are they going to have corruptible bodies? No, they’re going to have immortal incorruptible bodies. *“For this corruptible must put on incorruption, and this mortal must put on immortality so when this corruptible shall have put on incorruption and this mortal shall have put on immortality then shall be brought to pass the saying that is written, Death is swallowed up in victory,”* and so forth. Now, you getting the picture?

Now, let’s go back to **Romans 6**. Let me show you something. Would you look what Paul does not say? Listen to what he doesn’t say. He doesn’t say: let not sin therefore reign in your soul. He doesn’t say: let not sin therefore reign in your spirit. He doesn’t say: let not sin therefore reign in you. He says, “Don’t let it reign in your, what? **Your mortal body.**” That’s the only place sin can operate. Why? Because the real you, the real self is holy now. And that’s why you have this struggle in **Romans 7** where you say, I want the right things. That’s coming from the real me, but my body is a problem to me. Have you noticed that? I’ve noticed that.

Bruce Hurt: Keep in mind the cultural context in which Romans was written. Gentile (and Jewish) citizens of ancient Rome had a firsthand understanding of **presenting sacrifices** which would have helped them understand the picture of Paul's call to stop presenting themselves to Sin. Modern believers do not have this understanding of a sacrifice and there is a tendency to take this serious call less seriously or with indifference, much to our loss. There will be NO God blessed ministry without a Spirit empowered **separation** (stop presenting) and **consecration** (presentation to God)! Before a priest in Israel could minister on behalf of others, he was obliged to present himself in a consecrated condition and the sacrifices he offered were to be without blemish (**Mal 1:8, 9, 10, 11, 12, 13**).

Leedy Greek NT Diagrams:

Rom 6:12-13

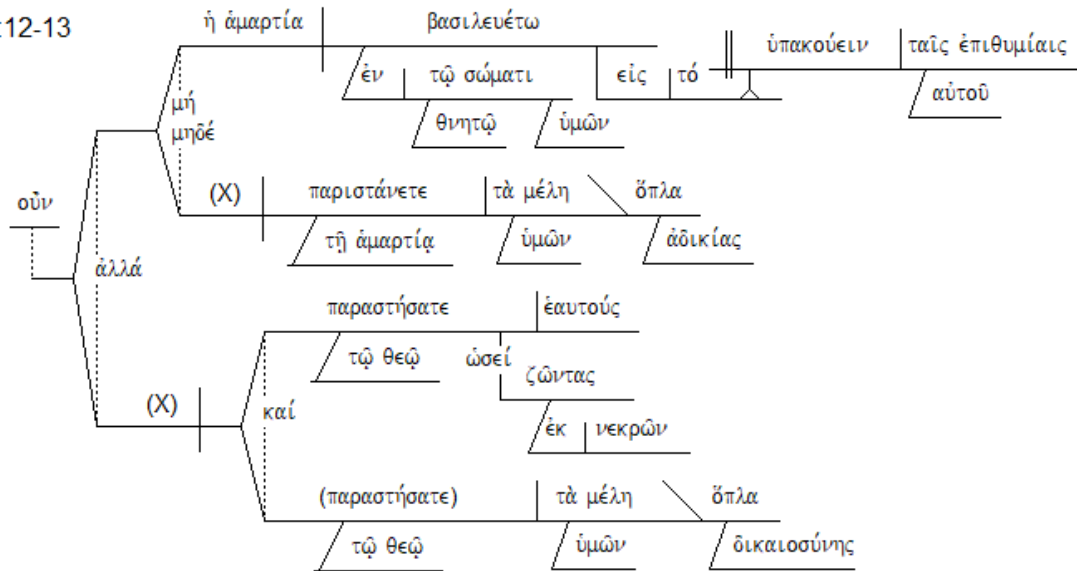

Rom 6:14

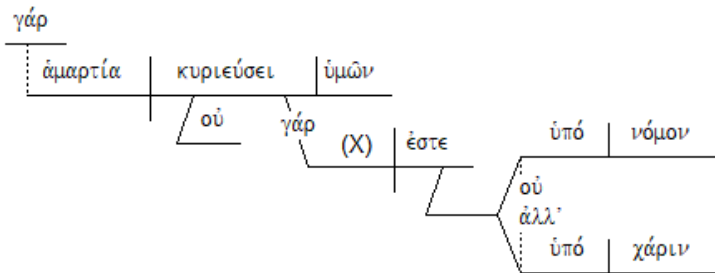

Frank Thielman:

- 12a Exhortation **Let not sin,**
- b Result therefore, **reign in your mortal body** with the result that you obey its lusts.
- 13a Exhortation **And do not offer your members** to sin as weapons of unrighteousness,
- b Contrast (to 13a) but **offer yourselves** to God, as alive from the dead,
- c Contrast (continued) and **your members** as weapons of righteousness.
- 14 Explanation (of 13b–c) For **sin will not rule as lord over you,** for **you are not under law** but **under grace.**

TEXT: ROMANS 6:15-23

TITLE: FREEDOM FROM THE LAW IS NO LICENSE TO SIN

BIG IDEA:

GRACE HAS TRANSFORMED US FROM SLAVES OF SIN TO SLAVES OF RIGHTEOUSNESS WITH BENEFITS OF SANCTIFICATION AND LIFE

INTRODUCTION:

Douglas Moo: Paul carries forth the theme of **6:1–14** in this section. He continues to proclaim that believers are set free from sin (**vv. 18, 22**). But the emphasis shifts slightly. Whereas **freedom** was the dominant motif in **verses 1–14**, **slavery** now takes center stage. Paul uses this imagery both to remind us of what our state used to be (“*slaves to sin*,” **vv. 17, 20**) and to encourage us to recognize what we have now become in Christ (“*slaves to righteousness*,” **v. 18**; “*slaves to God*,” **v. 22**). This paragraph focuses, therefore, on the transfer from one state of slavery to another and the implications that ensue from that transfer.

Thomas Schreiner: The thrust of Paul’s argument in **verses 16–23** is that being under grace doesn’t encourage believers to sin. If their lives are characterized by slavery to sin, the consequence will be eternal destruction. The power of grace must lead to a transformed life, for holiness of life is necessary for life eternal.

Frank Thielman: In **6:15–23** Paul focuses on the **metaphor of slavery** and explains two further consequences of the believer’s freedom from sin. First, freedom from sin and the law entails the domination of other powers: grace (**6:15**), righteousness (**6:18**), and God (**6:22**). Serving one’s self is not an option. To serve one’s self, as we just saw in the application of **6:1–14**, is to serve sin, and as **6:16** and **18** make clear, **one serves either sin or righteousness**.

Second, Paul emphasizes the important role of the human will in living outside the power of sin. He started to address this second issue in the imperatival language of **6:11–14**, but now his appeal to the human will becomes even more pronounced. Believers are not the helpless victims of powerful forces beyond their control, whether death (**5:17**), the law (**5:20; 6:14–15**), or sin (**5:21; 6:6, 12–14**). Instead, because God has freed them from these powers, they can place themselves at the disposal of righteousness and God (**6:15–18**), and they must do this if they are to live in a way that is consistent with the gift of righteousness that God has graciously bestowed on them in Christ (**6:19–23**). . .

Main Idea: People are either slaves of sin, which leads to death, or slaves of God, choosing to act in righteous ways and, in the end, receiving eternal life. God has broken the power of sin over believers, and they are now under the power of his grace. As believers choose to live in a way that is consistent with this truth, they live righteous lives that identify them as the people of God.

Paul wants to show in this passage that the freedom of believers from sin and from sin’s use of the law does not mean that believers are now free to sin. Rather, the reverse is true. Believers are

now obligated to God and capable of serving him by means of righteous behavior because sin's sway over them has ceased. As Paul's twofold use of the term "*sanctification*" (6:19, 22) shows, moreover, this new obligation plays an important role in God's purposes for his people.

Grant Osborne: In verse 1, Paul was challenging the crude assumption that sinning will give God the opportunity to exercise more grace. Here, Paul is guarding against the assumption that because sin is no longer our master, we can indulge in sin without fear of being controlled by it. Being under grace and under the mastery of Christ allows us the freedom not to sin. Any attitude that welcomes, rationalizes, or excuses sin is not grace, but slavery to sin itself. . .

All human beings are enslaved. While this idea clashes with our goal of independence, the fact is that we were created for interdependence. Paul is using a "*human term*" (6:19) to make an important spiritual point. Life is filled with choices about who and what we will obey. Another way of expressing Paul's phrase is, "You are a slave to whomever or whatever you commit yourself to obey." This means that friendships, goals, employment, citizenship, membership, education, career, debt, and marriage all include **aspects of slavery**. We should **choose our slavery wisely**. When sin is our master, we have no power except to do what it bids us. . .

Michael Bird: In terms of flow of thought,

- (1) Paul opens with a rhetorical question about the possibility of remaining in sin if one abides in grace and not law (v. 15).
- (2) This is answered with a further rhetorical question requiring a negative answer since servitude implies obedience. Obedience to sin leads to death, while obedience to God leads to righteousness (v. 16).
- (3) Furthermore, the Roman believers have been set free from slavery to sin by obeying the pattern of teaching given in the gospel and so become slaves to righteousness (vv. 17 – 18).
- (4) That point is underscored by contrasting slavery in sin leading to wickedness and slavery to righteousness leading to holiness (v. 19).
- (5) Paul follows it up with a biographical reminder about their former way of life controlled by sin, which led to shame and death, and their new life in Christ, which leads to holiness (vv. 20 – 22).
- (6) Finally, Paul recaps his main point that believers are free from sin and slaves to God and are thus able to receive the gift of eternal life (v. 23).

I. (:15-18) FREED TO PURSUE THE MASTER OF RIGHTEOUSNESS – SIN SHOULD NO LONGER BE AN OPTION FOR THE BELIEVER BECAUSE WE ARE NOW SLAVES OF GOD'S RIGHTEOUSNESS

A. (:15) Absurd Question: Does Grace Encourage Sin?

*"What then? Shall we sin because we are not under law but under grace?
May it never be!"*

The bottom line answer – committing sin cannot even be an option – don't even go there in your thinking

David Thompson: In this verse we see the desire or wish of God is that we never allow sin to master us. Now there is a very important difference between the question in this verse and the question in **verse 1**. The difference is the **tense of the verb**. In **verse 1** it is present tense meaning continuing in sin, and in **verse 15** it is an aorist tense meaning a specific moment of sin.

By using this tense we learn an important point and that is, a series of specific moments of sin are that which lead sin to have mastery over an individual.

Frank Thielman: The passage begins with a rhetorical question in **6:15** that Paul's potentially controversial statement about the law at the end of the previous section (**6:14**) prompted. If Christians are not under the law but under grace, then what guides their behavior?

Thomas Schreiner: The question posed in **verse 15** restates in different terms the question raised in **verse 1** (Murray 1959: 231). The two questions are distinct in that **verse 1** asks whether sin should be pursued so that grace would increase, while **verse 15** queries whether sin should be committed *because* (ὅτι, *hoti*) believers are free from the law and under the power of grace (cf. D. Moo 1991: 413). The questions are similar in that the same result is contemplated: **Does the presence of grace justify or encourage continued sin?**

John MacArthur: And this is always the antagonist's criticism of the message of grace, that grace leads to lawlessness, grace leads to antinomianism, grace leads to unbounded liberty, grace leads to abuse. And so, people say, "You can't just preach grace. You can't turn people loose. You've got to preach the law and the rules," and so forth. And so, the question comes, "Shall we sin because we're not under the law, but under grace?" Do people who are under grace just go wild on their sin? The answer is, "*God forbid. No, no, no.*"

B. (:16) Your Allegiance Determines Your Moral Behavior and Ultimate Destiny

"Do you not know that when you present yourselves to someone as slaves for obedience, you are slaves of the one whom you obey, either of sin resulting in death, or of obedience resulting in righteousness?"

Everybody makes the choice to obey (submit) someone or something. That becomes your Master.

Thomas Schreiner: The contrast between "*sin*" and "*obedience*" helps us grasp the meaning of the term "*sin*" here as well. Doubtless sin continues to be understood as a **power**, since as we saw above, the text often portrays people as slaves to sin. It would be an error, however, to separate sin as a power from **specific acts of sin**. This is borne out by the contrast between sin and obedience in **verse 16**, for just as obedience entails submission to specific precepts, so too sin is translated into concrete acts. That sin involves specific actions is also suggested by **verse 19**. Instead of the word "*sin*," the words ἀκαθαρσία (*akatharsia, uncleanness*) and ἀνομία (*anomia, lawlessness*) are found, both of which surely denote particular sinful behaviors. It is not surprising that both the power of sin and sinful actions are intended here, since the two are logically connected.

John Murray: the apostle shows in this verse that there are only two alignments in the ethico-religious realm and that the criterion of our alignment is that to which we render obedience, whether it be “*sin unto death*” or “*obedience unto righteousness*”.

What is meant by “*death*” in this instance is difficult to determine. Most probably it is used inclusively to refer to death in all its aspects, culminating in that eternal death of “*everlasting destruction from the presence of the Lord and the glory of his power*” (**II Thess. 1:9**). Sin is deathly and death in every respect follows in its wake. Similarly the righteousness which obedience promotes should also be interpreted inclusively to refer to righteousness in all its aspects, culminating, indeed, in the consummated righteousness of the new heavens and the new earth.

Grant Osborne: What are the Characteristics of Obedience?

- Willing loyalty
- Quick responsiveness
- Intuitive understanding
- Readiness to change
- Eagerness to learn

Douglas Moo: Some interpreters think that “*righteousness*” here has forensic flavor and refers to vindication at the judgment (see “*life*” in vv. **22, 23**). But Paul is obviously using *dikaio*-language in a different nuance here from what he did in **chapters 1–4**. In keeping with Old Testament and Jewish usage, righteousness has a moral sense: **conduct pleasing to God**.

John MacArthur: Here, the idea is the **slavery analogy**. When you became a Christian, what did you say, in effect? I submit myself to whom? To God through Christ.

Now let me put it as simply as I can. **There is no salvation apart from such a conscious submission.** That would destroy Paul’s whole point here. When you come to Christ, you come as a slave to a master, as a servant to the Lord. No other terms. And when you say, “I come as a slave or a servant to the Lord and Master,” you are affirming your commitment to be subject to Him. . .

Start with the **position**; you’re either in slavery to sin or slavery to God. The **practice**; your life is either progressing viler and viler and viler, or holier and holier and holier. And then the **promise**, the end over here is “*death*”; the end over here is “*everlasting life*.”

C. (:17-18) Transformative Change in Allegiance

1. (:17) Breaking the Former Allegiance to Sin by Obedience to the Gospel

“But thanks be to God that though you were slaves of sin, you became obedient from the heart to that form of teaching to which you were committed,”

Thomas Schreiner: Paul is probably thinking of the **conversion** of the Roman Christians, in which they exercised “*the obedience of faith*” (**1:5; 16:26**). The word ὑπηκούσατε (*you have become obedient*) emphasizes the decision to submit to God, while the words ἐκ καρδίας (*from the heart*) reflect the depth of that obedience. No superficial obedience was involved; it was a

willing and glad-hearted obedience to the gospel of Christ. Such obedience reflects God's new-covenant work in the hearts of believers (**Jer. 31:31–34; Ezek. 36:26–27**). Nonetheless, thanks are offered to God for their glad-hearted obedience because it was **his work** that led to their obedience. Such a statement does not deny the authenticity of human decision in submitting to God, but in typical biblical fashion Paul attributes the decision ultimately to God's grace and power. Indeed, God must be the one who causes obedience to rise in human hearts because all human beings are "*slaves of sin*." To be a slave of sin means that one is under its lordship and dominion and thus unable to extricate oneself from its tyranny. God in his grace broke the shackles of sin so that glad-hearted obedience became a reality for the Roman Christians.

John Murray: It is "*the form of sound words*" (**II Tim. 1:13; cf. I Tim. 1:10; II Tim. 4:3; Tit. 1:9; 2:1**), and in this instance there is stress upon the **ethical implications** of gospel teaching.

Douglas Moo: Why does Paul say "*form of teaching*"? It is unlikely that he is thinking of a certain form of Christian teaching as opposed to another form since he speaks so generally here. More likely he is contrasting the Christian pattern of teaching with the Jewish pattern (see **2:20**). Believers are not "*under*" the law of Moses (**6:14–15**), but they do have a pattern of teaching for which they are responsible.

2. (:18) Beginning a New Allegiance to Righteousness

"and having been freed from sin, you became slaves of righteousness."

II. (:19-23) FREED TO BENEFIT FROM THE FRUITS OF RIGHTEOUSNESS -- SANCTIFICATION AND ETERNAL LIFE

A. (:19) Obey Your Master

1. Accommodation: Using the Analogy of Slavery

"I am speaking in human terms because of the weakness of your flesh."

Frank Thielman: Slavery is a harsh institution and therefore an inadequate, albeit necessary, analogy to the believer's relationship to righteousness. . . . As Paul will say in **8:15**, the believers in Rome are not slaves cringing in fear of harsh masters but adopted children of God with all the affection and privilege that comes from this status. The expression "*in a merely human way*" refers to activity (in this case, speech) that is ordinary and therefore not ideal for an explanation of divine truth (cf. **1 Cor 2:13**). The fleshly weakness of Paul's Roman readers makes such inadequate analogies necessary not because their ability to grasp spiritual truths is less astute than that of others (cf. **15:14**) but because even believers are still in the flesh and affected by its sinful tendencies.

John Murray: When the apostle says, "*I speak after the manner of men*" he is referring to the form of his teaching in the preceding and succeeding verses. He describes the condition of unbelievers as slavery to sin and he also describes the state of believers as bond-service to righteousness. The institution of slavery, well known to his readers, is the medium through which he expresses the truth. In using this analogy drawn from the sphere of human relations he speaks after the manner of men. After all, the new life in Christ is not "slavery" as it exists among men; it is the highest and only freedom. But the institution of slavery does service to set

forth the totality of our commitment to God in that emancipation from the bondage of sin which union with Christ involves. It is on account of the infirmity of their flesh that he speaks thus to his readers. The dullness of our understanding makes it necessary that we be taught the truth in figures drawn from the sphere of our human relations.

2. Argument of Consistency

a. Before Conversion You Consistently Served Sin

*“For just as you presented your members
as slaves to impurity and to lawlessness,
resulting in further lawlessness,”*

Thomas Schreiner: This verse opens an interesting window on the Pauline conception of **slavery to sin**. Unbelievers are totally subservient to sin as a power that exerts authority over their lives, but the slavery envisioned is not coercion. People don't submit to sin against their will. Rather, they “freely” and spontaneously choose to sin. In other words, unbelievers are slaves to sin in that they always desire to carry out the dictates of their master. This does not mean that those with addictions (e.g., to alcohol, pornography, or gambling) never wish to be freed. It means that the desire for these things is ultimately greater than the desire to be freed from them. Only God, therefore, can release unbelievers from such subjection to sin, since new desires are necessary to escape the bondage of sin. Of course, this is precisely what God has done. He has liberated believers from the tyranny of sin so that they “have become obedient from the heart” to the gospel. He has planted new desires within them.

b. Now Consistently Serve Righteousness

*“so now present your members
as slaves to righteousness,
resulting in sanctification.”*

Michael Bird: Although Paul keeps pressing the idea of freedom from the slavery of sin across **Romans 6**, he nonetheless sees this freedom as meaning entering into service to God. Humanity will serve, but it will be either sin or righteousness. The believers have, by obedience, placed themselves in service to a new Lord, who summons them to a new pattern of behavior. A shift in lords requires a change in how believers use the members of their body. **Moo** puts it well: “The Christian is not just called to do right in a vacuum but to do right out of a new and powerful relationship that has already been established.”

Douglas Moo: “Holiness” (*hagiasmos*) denotes either the state of holiness or the process of sanctification. In either case, Paul sees our commitment to righteousness as resulting in God-likeness. In an interesting comparison, Paul suggests that our commitment to serve righteousness should be just as strong as our previous commitment to “*impurity*” and “*wickedness*.” One thinks of the single-minded pursuit with which some people seek fame, money, or power. Our pursuit of righteousness and holiness should be just as dedicated.

B. (:20-21) Overthrow Your Former Life of Sin

1. (:20) Slavery to Sin Made Righteousness Impossible

“For when you were slaves of sin, you were free in regard to righteousness.”

Frank Thielman: Paul's ethical admonition in **6:19**, then, is surrounded on both sides by the change in lordships on which it is based. The gospel has freed them from bondage to sin and placed them under the authority of righteousness.

2. (:21) Slavery to Sin Leads to Shame and Death

“Therefore what benefit were you then deriving from the things of which you are now ashamed? For the outcome of those things is death.”

Thomas Schreiner: Slavery to righteousness is certainly preferable to slavery to sin, since the former yields good fruit and leads to sanctification and eternal life, whereas the latter produces shame and has eternal punishment as its consequence.

C. (:22-23) Obtain Your Benefits

1. (:22) Explanation of Benefits for Serving Righteousness: Sanctification and Eternal Life

“But now having been freed from sin and enslaved to God, you derive your benefit, resulting in sanctification, and the outcome, eternal life.”

Frank Thielman: The result of this fruit is **sanctification**, and the “goal” of this way of living is **eternal life**. The expression “*the end*” (τὸ τέλος) suggests the image of a journey that has reached its goal (τέλος). This, in turn, implies that Paul has been speaking of a way of life that progresses in sanctification, with the people of God continuing to act in righteous ways that set them apart from unbelievers and, then, in the end, sharing God's life forever.

John Murray: The leading feature of the contrast in **verse 22**, however, is the emphasis upon the **fruit enjoyed and the issue resulting**—“*ye have your fruit unto holiness, and the end eternal life*”. In the service of sin there was no fruit; now they bear fruit that is unto holiness. And this fruit-bearing has its final issue in eternal life. Just as death, the issue of sin (**vs. 21**), should be taken inclusively, so should eternal life. While not restricted to the consummated life of the world to come this must, nevertheless, be included. The final issue of deliverance from sin, of bond-service to God, and of the fruit-bearing that is unto holiness is the possession of life incorruptible in the age to come.

2. (:23) Contrast with Wages of Serving Sin

“For the wages of sin is death, but the free gift of God is eternal life in Christ Jesus our Lord.”

John Murray: But the precise thought is that the free gift consists in eternal life. When wages are in operation our lot is death, inescapably and in its ultimate expression. When the free gift of God is in operation our lot is life, eternal and indestructible. How totally alien to such contrasts is the importation of merit in any form or degree into the method of salvation.

Grant Osborne: You are free to choose between two masters, but you are not free to adjust the consequences of your choice. Each of the two masters pays with his own kind of currency. The currency of sin is death. That is all you can expect or hope for in life without God. Christ's

currency is eternal life—new life with God that begins on earth and continues forever with God. What choice have you made?

Review of vv. 19-23:

- a. Purpose of using the illustration of slavery: our basic human nature is weak and needs concrete human illustrations to better grasp the truths of God (:19a)
- b. An exhortation: we are to use our bodies in a new way (:19b)
- c. Explanation of the inconsistency of continuing to choose to act ungodly: when we were under the dominion of sin it was understandable (but still not right) that we chose to live in sin; but now things are different (:20)

(Illustration: a disturbance at a jail is no big deal since we expect criminals might act that way)
- d. Learning from the past: reflect on our past choices of sin before we trusted Christ -- How did they benefit us? (:21)
 - 1) They have no benefit
 - 2) They bring only shame (Illustr.: overhead projector for displaying our past life of sin)
 - 3) They lead to death (separation from what is good, worthwhile)
- e. Reflecting upon the present (:22)
 - 1) we have been set free from sin's dominion
 - 2) we have now become enslaved to God and His righteousness
 - 3) as slaves of God's righteousness there is much benefit:
 - a) we will bear fruit (if no changed life, then no union with Christ)
 - b) we are maturing in personal holiness
 - c) at the end of our journey in holiness is life eternal (:23)
 - 1)) eternal not just in duration but in quality of life it is supreme
 - 2)) this eternal life is not a result of righteous obedience, but a free gift
 - 3)) God's free gift of eternal life is granted to those who are in Christ

* * * * *

DEVOTIONAL QUESTIONS:

- 1) If we are preaching the gospel of grace biblically, should we expect to have to answer the same type of objections that Paul faced?
- 2) Does our culture have some built-in reluctance to learn biblical truths from any analogy to

slavery?

3) What motivates you to serve righteousness rather than sin?

4) What are the distinctions between wages and free gifts?

* * * * *

QUOTES FOR REFLECTION:

Frank Thielman: Slavery to Righteousness and God Replaces Slavery to Sin (6:15–23)

- a. The thesis: people are enslaved either to sin or to God (6:15–16)
- b. The basis for Paul’s admonition: the gospel’s reorientation of the believer’s life (6:17–18)
- c. A caveat: the inadequacy of the slave metaphor (6:19a)
- d. Paul’s admonition: offer one’s self as a slave to righteousness (6:19b–e)
- e. A restatement of the basis for Paul’s admonition: the gospel’s transformation of the fruit of one’s life (6:20–22)
- f. A summary: death as sin’s wages and eternal life as God’s free gift (6:23)

S. Lewis Johnson: Only Two Masters

So service to God, service to righteousness, the theme is **non-continuance in sin**. What the apostle does not say, but what is said elsewhere in the Bible and in the apostle’s writings as well if we continue in sin then we are not believers. The kind of salvation that does not bring us any deliverance from sin is not the salvation spoken of in holy Scripture. The very fact that it is called salvation means that we must have some salvation from sin. The essence of sanctification as is taught here is traced to the believer’s union with Jesus Christ in his death, burial, and resurrection. What Paul says, essentially, is we are on the far side of our Lord’s death, burial, and resurrection. In him as our representative we have judicially passed out of this sphere of life, the old sphere of life, and are now on the other side of the cross identified with him in his death, in his burial, in his resurrection. Paul elsewhere says we’ve even been raised up and have been made to sit together with him in heavenly places. This is the judicial side of our relationship with the Lord God.

In **verse 1** when the apostle said, “*Shall we continue in sin that grace may abound?*” he uses the **present tense** of this verb continue. Shall we go on abiding in sin? He’s talking about a continuation in the life of sin. But in **verse 15** when he says, “*What then? shall we sin,*” he does not use the present tense of the verb, to sin, here but rather uses the **aurist tense** here or the tense that means something like undefined action. And it is possible for this to be understood as not a life of sin but of an incidental isolated act of sin.

Now I want to say that the majority of the commentators have not noticed that point, and so they take this question in **verse 15** to be essentially the same as that in **verse 1**. I do not think that would lead us into any error at all, but it is possible that the apostle is **asking a slightly different question here**. Since we are not under the law but we are under grace as believers is an isolated act of sin permissible? Granted we cannot continue in sin, but is it possible for us every now and then to sin with the approbation of heaven realizing that after all we still have the sin principle

dwelling within us? . . .

Now having given that answer which is essentially that we're created for mastery by one or the other of these principles and individuals the apostle in the remainder of the chapter says that now as a slave to righteousness we cannot sin recklessly and unresistingly. Even when we sin we do not like the sin that we have committed. **A believer cannot possibly engage in sin and relish that sin. A believer is very unhappy in his sinning.** He may lapse into sin, but he's very unhappy about it. Not only because the Holy Spirit brings conviction, but because he himself has a new inclination, and he wants to please his master. He's like Peter who when he denied the Lord went out and wept bitterly over the fact that he had denied the Lord. No Christian, no true believer relishes sin. If you relish sin there is a serious question about your faith in Jesus Christ, in spite of your profession. That's a very serious point and one the apostles make over and over and over again, and one which, unfortunately, some evangelicals have failed to pay attention to. The Bible makes it very plain that not only should believers not sin, but believers cannot continue in sin. They cannot. If we have been born of God we do not practice sin. I say we may lapse into sin. We may fall into sin, but we are very unhappy when that happens.

David Thompson: A BELIEVER UNDER GRACE IS NEVER TO BE A SLAVE OF SIN BUT SHOULD BECOME A SLAVE OF RIGHTEOUSNESS.

In these verses there are three main reasons why we should never be a slave to sin:

REASON #1 – We should not be a slave to sin but a slave to righteousness because this is consistent with God's desire. **6:15**

Now the mood of the verb "*may it never be*" is **Optative**. It is a very rare mood in the Greek text. In fact it is only used 67 times in the entire New Testament. The optative mood is the mood of strong wish or desire .

According to **Dana and Mantey**, two esteemed New Testament Greek grammarians, when a negative is used with this mood, it completely negates or demolishes the previous statement or assertion. In other words, in the mind of God and Paul, **the strong desire or wish is that the kind of thinking that specific moments of sin are okay needs to be demolished.** The thought that someone can look at the grace of God and then purpose to have specific moments of sin is totally contrary to God's Word and wish.

REASON #2 – We should not be a slave to sin but a slave to righteousness because this is consistent with our responsibility. **6:16**

The practical implication of this verse is that we will become a slave to whatever we are continually submitting ourselves to. Whatever we continually obey, that is to which we will become a slave. The word "*obey*" is used three times in this verse and it means to respond favorably to something you hear, such as a knock at a door or a military command (**G. Abbott-Smith**, p. 456).

The word "*present*" is one that means to stand beside or to come alongside of. Paul's point here

is, whatever we are continually coming alongside of and responding favorably to - it is that to which we are enslaved.

REASON #3 – We should not be a slave to sin but a slave to righteousness because this is consistent with our position. **6:17-23**

Steven Cole: So how do you win over sin? How do you experience consistent victory? First, receive the gift of eternal life. If you have never trusted in Christ, you are hopelessly, helplessly under the reign of sin and death. But Christ died and rose again to free you from sin. You must be born again in order to conquer sin.

Then, present yourself to God as a slave of righteousness. He is your new Master. You no longer have authority over your body. He does. Obey His Word. Remember your **shameful past** as a slave of sin before He redeemed you. Keep in mind your **blessed present**, enjoying all of the unfathomable riches of Christ. Look forward to your **glorious spiritual future** of eternal life free from all sin in the presence of the One who died to save you. You won't be sinlessly perfect in this life, but you can grow in holiness and consistently win over sin.

John MacArthur: Now, we learned in the first fourteen verses of the chapter that we're united with Jesus Christ in His death and resurrection, and thus we have died to sin and risen to walk in newness of life. The penalty for sin has been paid in that death. The power for sin has been broken, and we walk now in newness of life, alive to God. And now in verses 15 to 23, Paul demonstrates that we are made holy in another analogy. Not only have we died in Christ and risen in Christ and now are walking in a new life, having died to the old one, but we also have become slaves to God and in so doing the slavery to sin which was characteristic of our former life has been broken. So, he really is coming at the same thing from two different perspectives. He shows the believer has a totally new relationship to sin after salvation, different than before because he died in Christ and rose in Christ and because he has a new master which obviates the old master. That's the thrust of the second half of the chapter. And in both cases, his point is to show that a truly regenerated person cannot go on in the same pattern of sinning that was characteristic of his life before he was saved. Why? Because **we are no longer in the same relation to sin**. We have died in Christ and risen. We have now, in the second half of the chapter, **a new master** which means we no longer are under the old master.

Godet: The new principle had just been laid down. The apostle had found it in the object of justifying faith. But could a principle so spiritual, apart from every external and positive rule, take hold of the will with power enough to rule it thoroughly? To this natural objection, formulated in **Ro 6:15**, St. Paul answers as follows: by the acceptance of grace a new master has been substituted for the former, sin (**Ro 6:16, 17, 18, 19**); and the believer feels himself obliged to serve this new master with the more fidelity because he rewards his servants by communicating life to them, whereas the former master pays his by giving them death (**Ro 6:20, 21, 22, 23**). Thus it is proved that the new principle is clothed with sufficient, though purely internal authority, to control the believer's entire life.

Leedy Greek NT Diagrams:

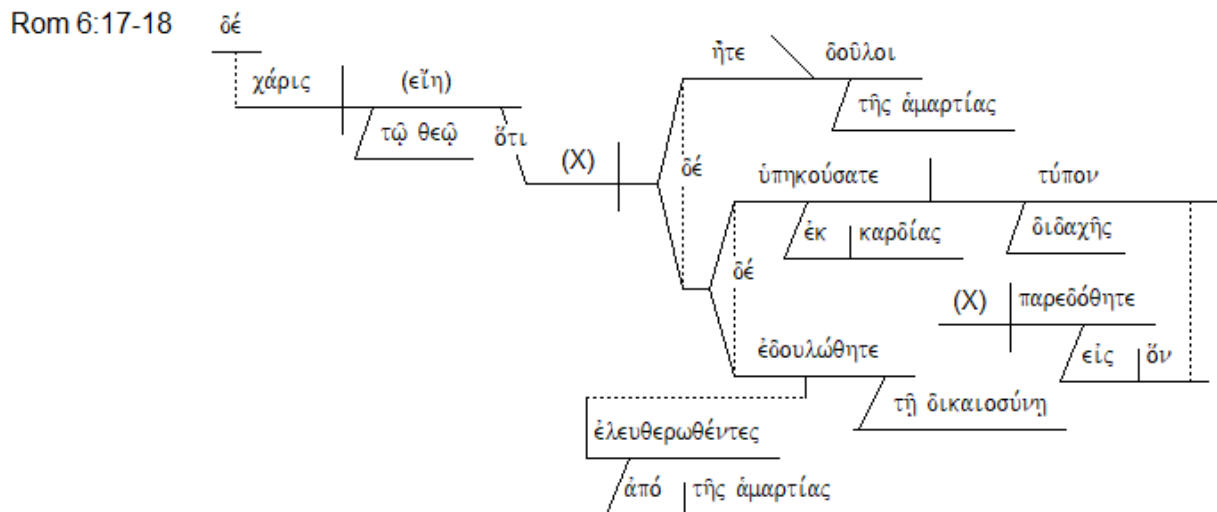
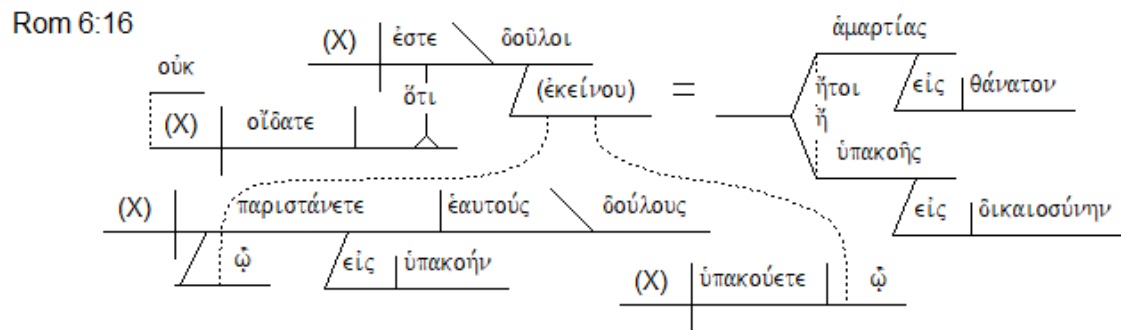
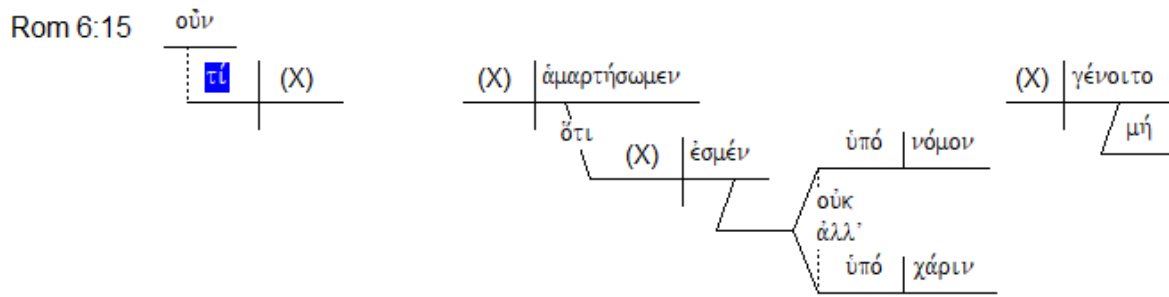

Rom 6:19

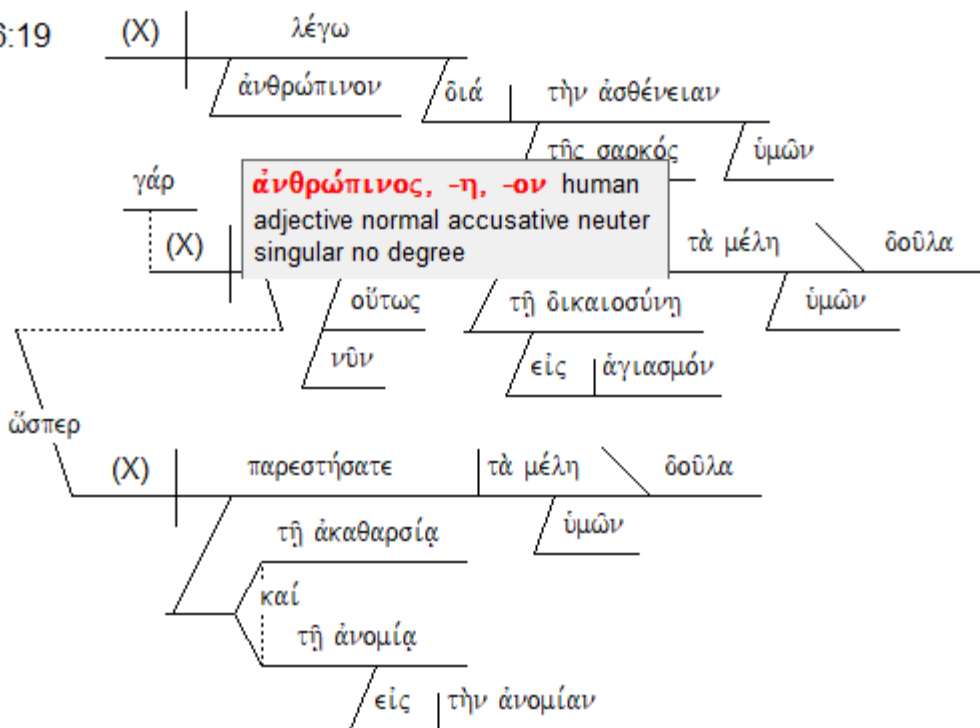

Rom 6:20

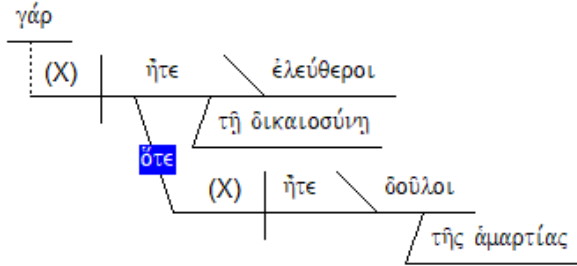

Rom 6:21

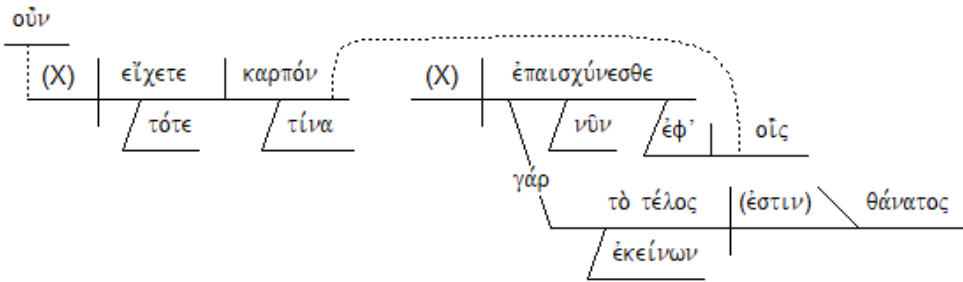

Rom 6:22

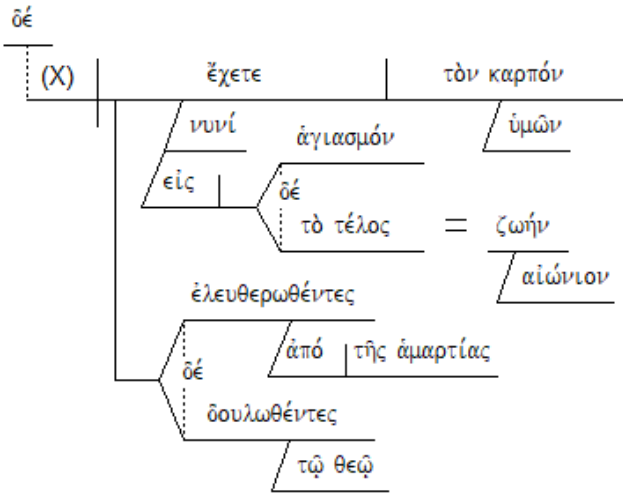

Rom 6:23

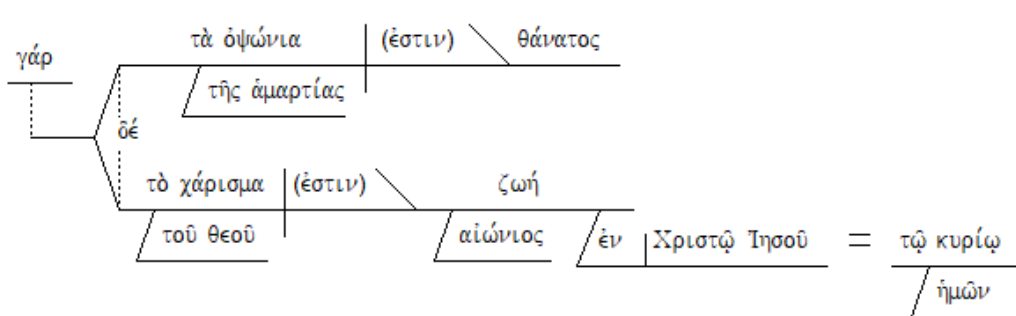

Frank Thielman:

- 15a Rhetorical Question **What, then?**
b Rhetorical Question **Should we sin** because we are not under law but under grace?
c Exclamation **Certainly not!**
- 16a Rhetorical Question **Do you not know that** to whom you offer yourselves as slaves for obedience,
b Assertion **you are slaves** to the one whom you obey, whether
c Alternative of sin, resulting in death, or obedience, resulting in righteousness?
- 17a Contrast **But thanks be to God that you were slaves of sin**
b **but you began to obey** from the heart the imprint of the teaching to which you were ↺ handed over.
- 18a Explanation That is,
b Time when you were freed from sin
c Assertion **you became enslaved to righteousness.**
- 19a Assertion **I am speaking in a merely human way**
Cause because of the weakness of your flesh.
b Explanation For just as **you once offered your members** to impurity and lawlessness to be their slaves,
c with lawlessness as the result,
d Comparison so now **offer your members** to righteousness, to be its slave,
e with sanctification as the result.
- 20 Explanation For when you were slaves of sin
Assertion **you were free with respect to righteousness.**
- 21a Rhetorical Question **What fruit, then, did you use to have at that time?**
b Assertion **Things for which you are now ashamed!**
c Explanation For **the end of those things is death.**
- 22a Cause But now,
freed from sin and enslaved to God,
b Contrast **you have your fruit** with sanctification as the result, and the end is eternal life.
- 23a Explanation For **the wages that sin pays is death,**
b Contrast **but the free gift that God gives is eternal life in Christ Jesus our Lord.**

TEXT: ROMANS 7:1-6

TITLE: FREEDOM FROM THE DOMINION OF THE LAW -- A NEW WAY TO LIVE

BIG IDEA:

WE CAN SERVE GOD IN A NEW WAY THROUGH THE SPIRIT SINCE WE HAVE DIED TO THE CLAIMS OF THE LAW AND ARE NOW MARRIED TO CHRIST

INTRODUCTION:

Frank Thielman: In **7:1–25** Paul will address why the believer is no longer “*under law*” (**6:14–15**) from the perspective both of the law’s action on the individual sinner and from the perspective of God’s purposes for the law in history. He will explain in **7:1–6** how the law causes the trespass to increase and state that the era of the Mosaic law has given way, in God’s purposes, to the era of the Spirit’s outpouring, just as the law and the prophets testified.

Main Idea: Like a wife whose husband has died and who is now free from her legal obligation to remain faithful to her former husband, believers are free from the law. Their union with the crucified and risen Christ has released them from life “*under law*” in two senses. First, they are no longer under the power of the law, as sin used it to generate even more sin in their lives, and, second, they are no longer under the Mosaic law because the new outpouring of the Spirit through the gospel has signaled that the Mosaic law’s work is finished. . .

Paul makes two points in this passage, both of them about the Mosaic law.

- First, Christians now live in a new stage of salvation history in which the Mosaic law’s rule over God’s people has ended. This freedom has come to Christians through their union with Christ’s death and resurrection.
- Second, the Spirit has freed Christians from the tendency of the law to increase human rebellion against God and has empowered them to live in ways that are productive and useful for the service of God.

Douglas Moo: The negative effect of the Mosaic law has been a recurring motif in Romans. Paul has argued that possession of the law did not improve Israel’s situation before the Lord. For it is not possession of the law but obedience that counts, and Israel failed to fulfill the law (**2:12–13, 17–24**). As a result, the law is unable to justify a person (**3:20, 28**). In fact, the overall impact of the law on Israel has been negative: It stirs up consciousness of sin (**3:20**), brings wrath (**4:15**), and increases trespass (**5:20**). If Christians are to be free from sin, they must therefore also be taken out from under the law’s binding authority (**6:14–15**).

In **7:1–6** Paul gathers up these points into a section that directly addresses the negative effects of the Mosaic law and its relationship to believers. Arising directly from the “*not under law, but under grace*” contrast of **6:14–15**, these verses assert that Christians have been set free from the binding authority of the Mosaic law (**7:4**, the center). **Verses 1–3** lead up to this central point with a general principle and illustration; **verses 5–6** provide further explanation and elaboration.

I. (:1) THE AXIOM = BASIC PRINCIPLE - LAW HAS JURISDICTION THROUGHOUT LIFE

“Or do you not know, brethren (for I am speaking to those who know the law), that the law has jurisdiction over a person as long as he lives?”

Frank Thielman: Although Paul himself considered the Jewish Scriptures to be authoritative (1:2), he has made several surprising comments in his argument so far about a central part of those Scriptures, the Mosaic law. He has said that God disclosed his righteousness apart from the Mosaic law (3:20), that the Mosaic law brings God’s wrath (4:15), that when it “*slipped in*” to history, it actually caused the violation of its own precepts to increase (5:20), and that believers are no longer “*under law*” just as they are no longer under the rule of sin (6:14–15). By the end of his discussion of the ethical consequences of the believer’s union with Christ (6:1–23), a discussion generated by his comments in 5:20 and 6:14, the pressure on Paul to explain how he could say these things about the law has increased to the breaking point. . .

In 7:1 Paul states a basic principle concerning the reach of the law that illustrates the main point of the passage. This principle is that a death has ended the power of the law over them. . .

The phrase “*under law*” (ὕπὸ νόμου) in Greek most naturally means “under the power of the law,” and Paul continues to think of the law here as something that exercises power over people, like a political figure who “*rules as lord*” (κυριεύω) over others (cf. 6:9, 14). Paul had said in 6:9 that death no longer “*rules as lord*” over the risen Christ, nor does it rule, he implies, over those who are united by faith with the risen Christ. He had said in 6:14 that sin should not rule as Lord over believers because they are no longer “*under law*,” and now he says clearly what 6:14 implied: the law also no longer rules as Lord over believers. [speaking of the **Mosaic Law**]

II. (:2-3) THE ANALOGY = MARRIAGE CONTRACT -- THE LIBERATING PRINCIPLE OF DEATH – DEATH RELEASES US FROM THE CLAIMS OF THE LAW

A. Essence of the Marriage Contract

“For the married woman is bound by law to her husband while he is living;”

Frank Thielman: The term “*married*” (ὑπανδρος) carried the nuance of subjection, by law or custom, to a man’s power (ὑπό + ἀνδρός) and was often used in discussions of a husband’s exclusive sexual rights to his wife (Prov 6:24, 29 [LXX]; Sir 9:9; 41:23; Polybius, Histories 10.26.3). The notion of subjection that the term conveyed suited Paul’s understanding of the law as a power that held people in subjection (cf. 7:6). . .

Both the present participle (ζῶντι [“*living*”]) and the perfect indicative (δέδεται [“*is bound*”]) communicate the **permanence** of the marriage bond for the woman while her husband is alive.

B. End of the Marriage Contract at Death

“but if her husband dies, she is released from the law concerning the husband.”

C. Essence of Adultery

1. When Adultery Exists

“So then if, while her husband is living, she is joined to another man, she shall be called an adulteress;”

2. When Adultery Doesn't Exist

“but if her husband dies, she is free from the law, so that she is not an adulteress, though she is joined to another man.”

Douglas Moo: Verses 2–3 are sometimes taken as an allegorical illustration of verse 4. The woman whose husband dies, freeing her from the “law of marriage,” is like the Christian who “dies to the law.” As the death of her husband allows her to marry another man, so the Christian’s death to the law allows him or her to “belong to another,” Jesus Christ. But to make the allegory work, some juggling with the parallels has to be done. In the illustration it is the death of the husband that brings freedom, but in the application the believer, not the law (= the first husband), dies. Various more or less ingenious attempts to make the allegory work have been proposed, but it is simpler to think of verses 2–3 not as an allegory but as an illustration of the point of verse 1 with some application to verse 4. Paul simply wants to show that a death can indeed bring freedom from the law; at the same time, he hints that such freedom can also lead to a new relationship.

Bob Deffinbaugh: No illustration is without its shortcomings, and this one is no exception. The analogy of the married woman does not precisely correspond to the death of the Christian to the Law, for the Christian died, but in the case of the married woman, it was her husband who died. Nevertheless, the point is clear. We died in Christ to sin and to the impossible demands of the Law which condemned us to death. Our death and resurrection in Christ has freed us from the jurisdiction and authority of the Law, and we are now free to choose another master, the Lord Jesus Christ, raised from the dead, to bear fruit unto God. How foolish to return to slavery to the Law and sin! How delightful the thought of servitude to God!

And so we see the implications of our death, burial and resurrection in Christ. We are released from the Law as a cruel taskmaster. We are free to become the servants of God.

S Lewis Johnson: Now we’re in the section in which he has been showing us how to be saved from the power of sin in our daily lives. Since only Christ can live the Christian life we need him. And Paul’s words are designed to show us how we have him. He’s talking about union, judicial union, in the first part of **chapter 6**, moral union in the later part of **chapter 6**, marital union here, spiritual or dynamic union, a union with the Holy Spirit involved in the first part of **chapter 8**, and in fact, we in one sense may go on and speak of the later part of the chapter as expressive of an eternal union because of the words the apostle speaks there. The figure that Paul has chosen in this part of Romans to express this particular relationship, this relationship of sanctification, both the process and particularly the union on which it is based is the figure of marriage, because the aim of natural life is the establishment of a home with a family. And so our marriage to our Lord Jesus Christ is designed to have spiritual significance that corresponds to the natural realm.

III. (:4) THE APPLICATION TO BELIEVERS REGARDING OUR DEATH TO THE LAW AND REMARRIAGE TO CHRIST – WE HAVE DIED TO THE LAW THROUGH CHRIST WHO HAS GIVEN US A NEW AND FRUITFUL MARRIAGE

A. Reality: Believers Have Died to the Law

“Therefore, my brethren, you also were made to die to the Law”

Died to the claims of the law –

- the law claims/demands perfection from us
- the law says we are guilty
- the law condemns us

Frank Thielman: In accord with the principle that people are only under the law’s authority while they are alive (7:1), and just as in marriage law a widow does nothing wrong if she lives with a second husband (7:2–3), so the Roman Christians have been released from the law’s power over them and empowered to live in ways that are pleasing to God. This has happened through their union with Christ who both died for their sins and was raised from the dead so that they might live productive lives in service to God. . .

Because believers are united with Christ, like Christ they have both died and are alive in a new way (cf. 6:1–14). Their death with Christ has broken the law’s power over them, and their new life in union with Christ and empowered by the Spirit enables them to serve God.

B. Instrumentation – How Did We Die to the Law

“through the body of Christ,”

C. Purpose = Remarriage to Christ

“that you might be joined to another, to Him who was raised from the dead,”

- Personal Relationship (not primarily about rules)
- Intimate Relationship (true union)
- Powerful Relationship

John Murray: Verse 4, therefore, is the unfolding of the way in which grace in contrast with law takes effect unto our deliverance from the dominion of sin. Law, as we found (6:14), confirms and seals our bondage to sin. As long as law governs us there is no possibility of release from the bondage of sin. The only alternative is discharge from the law. This occurs in our union with Christ in his death, because all the virtue of Christ’s death in meeting the claims of the law becomes ours and we are free from the bondservice and power of sin to which the law had consigned us. . .

Discharge from the law is not an end in itself; it is directed to a positive end. This is another way of setting forth what has been repeatedly noted in this part of the epistle, that union with Christ in his death must never be severed from union with him in his resurrection. Here, however, the

stress falls not merely on union with Christ in his resurrection but upon union with him as the one who has been raised from the dead. It is union with him, therefore, not only in the virtue and power of that historical event but union with him now and forever in that identity that belongs to him as the resurrected Lord. We can hardly suppress the application at this point of the **permanency** of the bond after the analogy of the marriage bond. “*Christ being raised from the dead dies no more*” (6:9) and this immortality seals the indissolubility of this marital bond (cf. **Eph. 5:22–32**). The end served by this union is that we may bring forth fruit to God (cf. **6:22**), fruit that is acceptable to God and redounds to his glory, a consideration directed against all licentious abuse of the doctrine that we are not under law but under grace.

John Toews: A transfer of **reigns** and **dominion** has occurred. Jewish Christians have exchanged the reign of Sin, 5:21a, for the reign of Grace, 5:21b. They no longer belong to Adam and his people but to Christ and his people. They are not under law but under grace so that they may bear fruit for God.

D. Ultimate Goal

“that we might bear fruit for God.”

Frank Thielman: The “*fruit*” imagery may be a continuation of the marriage imagery since marriage naturally yields the “fruit” of offspring, but in any case it certainly refers back to the ethical fruit of **6:22** that results in “sanctification.” As believers, united with the risen Christ and freed from sin’s use of the law to condemn them and engender further rebellion in them, Paul’s audience is now free to live in the way that God intended his people to live—as Christ’s sanctified, beautiful bride, without spot, wrinkle, or blemish (**Eph 5:26–27**; cf. **1 Cor 6:15–17**; **2 Cor 11:2**).

John Stott: whether ‘*fruit*’ means ‘children’ or not, all are agreed that the result of being released from the law and joined to Christ is **holy living**, not antinomian license. For becoming a Christian involves a **radical change of allegiance**. At the end of **chapter 6** our two slaveries were contrasted. At the beginning of **chapter 7** it is our two marriages, death dissolving the first and so permitting the second. Both metaphors speak of our **new freedom to serve**, which is the topic to which Paul now comes.

IV. (:5-6) THE ANALYSIS -- CONTRAST BETWEEN LIFE IN THE FLESH AND LIFE UNITED TO CHRIST

A. (:5) Life in the Flesh – Our Old Marriage to the Law Aroused Sinful Desires that Produced Fruit Leading to Death

1. Occasion

“For while we were in the flesh,”

Frank Thielman: “*in the flesh*” -- existence prior to union with Christ’s death and resurrection. This is existence, then, before God has broken sin’s dominion over the believer (**3:20**; **6:19**).

John Murray: “*Flesh*” in this ethically depreciatory sense means “human nature as controlled and directed by sin”. . . And neither are we to suppose that “*flesh*”, when conceived of as sinful,

derives this character from the physical. Sin does not arise from our bodily or physical being, and flesh when used simply of the physical as distinguished from the psychical has no evil connotation. It is when “*flesh*” is used in an **ethical sense** that it takes on this sinful quality. With that meaning it is used frequently, especially by Paul (**8:4, 5, 6, 7, 8, 9, 12, 13; 13:14; I Cor. 5:5; II Cor. 10:2; Gal. 5:13, 17, 19, 24; 6:8; Eph. 2:3; Col. 2:11, 18, 23; II Pet. 2:10, 18; Jude 23**). “*Flesh*” when used in this sense has no good or even neutral associations; it is **unqualifiedly evil**. Hence when Paul speaks of having been “*in the flesh*” he is referring to that period when sin exercised the dominion and is equivalent to saying “*when we were in sin*”.

2. Operation of Sinful Passions

“the sinful passions, which were aroused by the Law, were at work in the members of our body”

Frank Thielman: Anytime people are faced with the will of God, whether in the law or the gospel, and decide to assert their independence from God instead of trusting his word, they are acting out the principle that Paul articulates here.

Thomas Schreiner: The shocking statement in **Rom. 7:5** is that such desires for sin were aroused by the law (τὰ διὰ τοῦ νόμου ἐνηργεῖτο). The typical Jewish view was that the law helped to prevent people from sinning. Paul contends that the law aids and abets sin, that sin is provoked and stimulated by means of the law. Jewish history supports Paul’s contention, for under the law Israel ended up in exile because of its sins. The point of this discussion is now clear: **Cranfield’s** view (1975: 336, 338) that Paul is referring only to the condemnation of the law is not comprehensive enough. Paul is also thinking of the law as a **power** that wields influence over human beings and exercises control by abetting sin.

Bruce Hurt: *Sinful passions* then describe those overwhelming impulses to think and do evil, which characterize those who are “*in the flesh*” (**Ep 2:3**), but which obviously can also affect true believers. Prior to our conversion we were ruled by sinful passions which were aroused by the law.

John Bunyan: Illustration from Pilgrim’s Progress -- He describes Interpreter’s house, which Pilgrim entered during the course of his journey to the Celestial City. The parlor of the house was completely covered with dust, and when a man took a broom and started to sweep, he and the others in the room began to choke from the great clouds of dust that were stirred up. The more vigorously he swept, the more suffocating the dust became. Then Interpreter ordered a maid to sprinkle the room with water, with which the dust was quickly washed away. Interpreter explained to Pilgrim that the parlor represented the heart of an unsaved man, that the dust was original sin, the man with the broom was the law, and the maid with the water was the gospel. His point was that all the law can do with sin is to **stir it up**. Only the gospel of Jesus Christ can wash it away.

3. Outcome

“to bear fruit for death.”

B. (:6) Life United to Christ – Our Death to the Law Frees us to Serve God in a New Way through the Spirit

1. Release from the Law's Oppressive Power

“But now we have been released from the Law,”

Frank Thielman: They have been released, then, from sin's use of the law to generate even more rebellion against God than would have been the case had they never encountered the law (**4:15; 5:13, 20**). . . Here, then, Paul speaks of the believer's release from the oppressive constraint that the law places on unbelievers when sin uses the law as a tool to engender further rebellion against God.

2. Death to Bondage to the Law

“having died to that by which we were bound,”

3. Service in Newness of the Spirit Contrasted with Oldness of the Letter

a. Newness of the Spirit

“so that we serve in newness of the Spirit”

Frank Thielman: As the terms “*newness*” and “*oldness*” hint, Paul describes here not merely a contrast between two modes of existence, one before and one after conversion, but also a contrast between two periods in salvation history, the present period dominated by the lavish outpouring of God's Spirit on his people (cf. **5:5**) and the prior period dominated by the rule of the Mosaic law among God's people.

Thomas Schreiner: the reference to the Spirit indicates a fulfillment of salvation history in which the promises of the new covenant are becoming a reality (**Jer. 31:31–34; Ezek. 36:26–27**). The contrast between “*newness*” and “*oldness*” here also signifies the disjunction between the **two covenants** (**Käsemann** 1980: 190). The genitives πνεύματος (*Spirit*) and γράμματος (*letter*) could be understood appositionally, “*newness in the Spirit*” and “*oldness in the letter.*” They are more likely both genitives of source, “*newness that has its origin in the Spirit*” and “*oldness that stems from the letter*” (**D. Moo** 1991: 445).

Bruce Hurt: *In newness* - In an atmosphere or environment that has never existed. "Breathe in" this newness. Walk in this newness. Serve in this newness. Remember you now exist in the sphere of newness of the Holy Spirit and don't foolishly fall into the trap of volitionally (you make the choice) placing yourself back up under the law in any form (especially those things that ostensibly "look good" and if carried out with the proper motive and "Spirit" are good).

b. Oldness of the Letter

“and not in oldness of the letter.”

- We have been brought to life and are now able to live for God
- Dependence on the power of the Holy Spirit is the key to freedom
- Serving God will result from this new marriage relationship to Christ

Bruce Hurt: *Oldness* (*palaiotes* from *palaios* = old in the sense of worn out, decrepit, useless) describes obsolescence, antiquatedness or oldness. *Palaiotes* describes one's characteristic state of being obsolete (or superseded). **Romans 7:6** (the only use in Scripture) describes God's "planned" obsolescence regarding the law.

John Murray: having died to the law and having been thus discharged from it, believers no longer serve in the servitude which law ministers but in the newness of the liberty of which the Holy Spirit is the author (cf. **Gal. 3:3**).

* * * * *

DEVOTIONAL QUESTIONS:

- 1) Are Christians under obligation to obey the Ten Commandments?
- 2) What are some wrong views of sanctification that are corrected by this passage?
- 3) Is it possible for a Christian to be completely unfruitful?
- 4) How can I better serve God in *newness of the Spirit*?

* * * * *

QUOTES FOR REFLECTION:

Thomas Schreiner: The general structure of **verses 1–6** is not difficult. **Verse 1** states the principle that the law rules over a person throughout life. **Verses 2–3** illustrate that principle by appealing to the wife's responsibility to the law, in that she should stay married to her husband while he lives. Only if he dies is she free from the law of the marriage bond. In **verses 4–6** a conclusion (signaled by the conjunction ὅστε, *hōste, so that*) is drawn from **verses 1–3**. Believers have died to the law through the death of Christ. They have been liberated from the law and now are **married to Jesus Christ**. God's purpose in wedding believers to Christ is to produce fruit in their lives. **Verses 5–6** are introduced by a γάρ (*gar, for*), and their function is to explain **verse 4** in more detail. Why do believers need to die to the law? Because, according to **verse 5**, the law in the unregenerate doesn't produce righteousness. Instead, the passions of sin are actually stimulated through the law, with the result that death is pronounced on such evildoers. **Verse 6** functions as a contrast (νυνὶ δέ, *nyni de, but now*) to **verse 5**, and the words νυνὶ δέ introduce the **new eschatological reality** inaugurated by Jesus Christ. Believers are no longer in the flesh, but they have been released from the power of the law and have died to its dominion over their lives. As a consequence they are no longer under the letter of the law, which produces only disobedience. Now they have the Holy Spirit and live a new life of holiness. . .

What it means to be *in the flesh*. . . Paul sharpens the meaning of the term, though, and uses it distinctively for human beings who are fundamentally opposed to God. The σάρξ (*flesh*)

describes human beings who are part of the old age and should be understood from the standpoint of redemptive history (see esp. [Russell](#) 1993; 1995). Those who are “*in the flesh*” are under the dominion of the powers of the old era. Some scholars have argued that any reference to “*sinful nature*” is inappropriate for the word “*flesh*” since it denotes a redemptive-historical reality instead of an anthropological one ([Dunn](#) 1988a: 363–64; [D. Moo](#) 1991: 442–43; [Russell](#) 1995: 334–36), but redemptive history and anthropology should not be pitted against each other. Certainly “*flesh*” denotes a salvation-historical reality, yet redemptive history cannot be separated from the nature of human beings, even if the term “*sinful nature*” is misleading in some respects. The ontological dimension of “*flesh*” is reflected in the phrase “*sinful passions*” (τὰ παθήματα τῶν ἁμαρτιῶν, *ta pathēmata tōn hamartiōn*) that were operative while “*we were in the flesh.*” Paul also refers to “*the flesh . . . with its passions and desires*” (τὴν σάρκα . . . σὺν τοῖς παθήμασιν καὶ ταῖς ἐπιθυμίαις, *tēn sarka . . . syn tois pathēmasin kai tais epithymiais*, [Gal. 5:24](#)) and says that the flesh “*desires*” (ἐπιθυμεῖ, *epithymeī*) certain things ([5:17–21](#)). In [Rom. 8:5–7](#) a “*mind-set*” (φρόνημα, *phronēma*) is ascribed to the flesh. It is hard to see how “*desires*” and “*thoughts*” can stem from the “*flesh*” if there is not an **anthropological** component involved. Desires and thoughts come from human persons. It is correct, then, to understand the “*flesh*” in terms of **redemptive history**, but redemptive history is crucial precisely because it impinges on who we are as **human beings**.

[John Toews](#): The parallel thematic structure belongs to [6:1ff.](#) and underscores the continuity of theme:

Ch. 6	7:1-6
6:1 Sin	7:1 Law
6:2 We died to sin	7:4 You died to the law
6:4 Walk in newness of life	7:6 Serve in the new life of the Spirit
6:7 He who died is free from sin	7:6 We are discharged from the law, dead to what held us captive
6:18 Set free from sin	7:3 Free from the law

[Douglas Moo](#): Does our freedom from the Old Testament law include even the Ten Commandments? Yes and no. Yes in the sense that those commandments as part of the Mosaic law no longer stand over us. But no in the sense that the teaching of nine of the ten commandments is explicitly taken up by New Testament authors and made part of the “*law of Christ.*” (The one commandment that is not taken over is, of course, the Sabbath command.) What all this means in practice, then, is that we should look to the New Testament for those commandments that express God’s moral will for us as new covenant Christians. Its teachings, properly interpreted, are to be obeyed. But this does not mean that we should no longer read the Old Testament law. It remains God’s Word, given, as all Scripture, for our enlightenment ([2 Tim. 3:16](#)).

Moreover, although the new covenant believer does not stand directly under Old Testament law, that law itself serves an important function in helping us understand our obligations. New Testament teachings are informed by the Old Testament law. For instance, the New Testament prohibits *porneia*—unlawful sexual conduct. But what is included in such illegitimate sexual conduct? The New Testament writers never spell it out because the scope of this conduct has been defined clearly in the Old Testament law. Thus, we continue to read the Old Testament law as a guide to our interpretation of New Testament law.

Steven Cole: Free from the Law

In my judgment, one of the most difficult theological issues in the Bible is that of the believer's relationship to the law of God. Since the word *law* is used 19 times in **Romans 7**, clearly that is Paul's theme. . .

So if we want to gain consistent victory over sin, we have to wrestle with **Romans 7** as Paul explains the purpose of God's law and our relationship to it. His thinking was radically opposed to the common Jewish views of his day. They would have said that the law was given to make us holy, but Paul says that the Law served to arouse us to sin! In **chapters 1-5** Paul shows that it is impossible to be justified by keeping the law. Here he shows that **it is impossible to be sanctified by keeping the law**. In fact, Paul argues that the law is actually a hindrance to sanctification (**Martyn Lloyd-Jones**, *Romans: The Law: Its Functions and Limits* [Zondervan], p. 5). . .

In our text (**7:1-6**), Paul first makes a general statement about the law's jurisdiction over a person as long as he lives (**7:1**). Then (**7:2-3**) he illustrates his point by showing that a woman is bound to her husband as long as he lives. He is not giving comprehensive teaching here about divorce and remarriage. Rather, he uses an analogy to make a point: the law has jurisdiction over the living, not over the dead. If a person dies, he is no longer under the law. Then (**7:4**), he applies the point, showing that we died to the law through the death of Christ. We are now "remarried" to Christ so that we might bear fruit for God. Then (**7:5-6**) Paul explains verse 4 negatively (**7:5**) and positively (**7:6**). We need to die to the law because it aroused our sinful passions to bear fruit for death (**7:5**). But in Christ we have been released from bondage to the law so that we serve God in newness of the Spirit (**7:6**). To summarize:

Through our union with Christ, we have died to the law so that we are free to bear fruit for God in the Spirit.

1. Through our union with Christ, we have died to the law, which only produced sin and death.

A. DYING TO THE LAW DOES *NOT* MEAN THAT WE ARE FREE FROM SPECIFIC MORAL COMMANDMENTS.

B. DYING TO THE LAW MEANS THAT WE ARE FREE FROM THE DEMANDS OF THE LAW AS AN IMPERSONAL SYSTEM FOR APPROACHING GOD.

C. DYING TO THE LAW MEANS THAT WE ARE FREE FROM THE CONDEMNATION OF THE LAW.

D. DYING TO THE LAW MEANS THAT WE ARE FREE FROM THE INABILITY OF THE LAW TO PRODUCE OBEDIENCE.

2. Having died to the law, we are now joined to Jesus Christ, which produces fruit for God in the Spirit.

A. OUR UNION WITH CHRIST IS A TRANSFORMING RELATIONSHIP.

B. OUR UNION WITH CHRIST IS A LOVE RELATIONSHIP.

C. OUR UNION WITH CHRIST IS A LIBERATING RELATIONSHIP.

E. OUR UNION WITH CHRIST IS A POWERFUL RELATIONSHIP.

F. OUR UNION WITH CHRIST IS A HOLY RELATIONSHIP.

John MacArthur: Dead to the Law

Now listen. The law is good. The law is holy. The law is righteous. The law is honorable. The law reflects the mind and heart of God. But nobody, no time, under any circumstances will ever be justified by keeping the law.

Now go to **5:20**. Moreover - if you don't get saved by the law, **what's the law for?** "*Moreover the law entered, that the offense might abound.*" In other words, instead of the law creating righteousness, the law made sin what? Abound.

Now let's go one more step, and we'll get to the 7th chapter. **6:14**. "*For sin shall not have dominion over you.*" And here is an absolutely shocking statement to a Jew who all his or her lifelong had been committed to the law. "*For sin shall not have dominion over you: for ye are not under the law, but under grace.*" **Now a statement like that has to be defended.** It just has to be defended. There's no way that Paul can make that statement in **6:14** and then walk away from it and write the rest of this epistle. It's going to leave such a massive block in their minds, he has to deal with what he just said. We are not under the law.

Now would you notice there are two basic statements in **verse 14**? "*For sin shall not have dominion over you.*" That's the first statement. Now listen carefully. He explained the meaning of that statement in **6:15-23**. That is an exposition of that statement. The second statement, "*for you are not under the law, but under grace,*" he explains in **chapter 7**. He makes those two statements, explains one, and then the other because he cannot leave them unexplained. For those who have such a high and sacred view of the law will be devastated by his statement and they will jettison all of his theology when he says "*you are not under the law.*" They have all their lifetime lived under the law. It's all they've known. So he must explain it. And I believe he does it in **chapter 7**. . .

Now let's take the first section of chapter 7 and look at it. I'm going to give you four points: The **axiom**, the **analogy**, the **application**, and the **affirmation**.

Leedy Greek NT Diagrams:

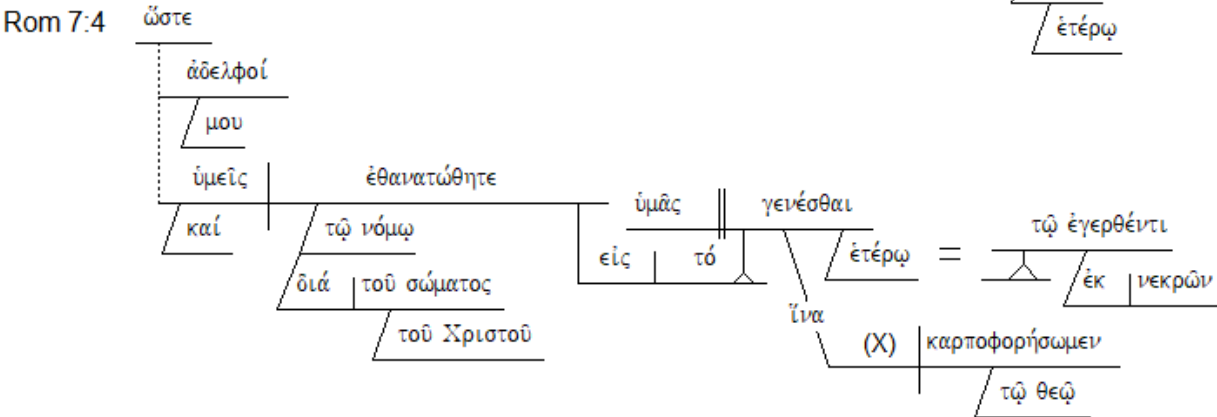
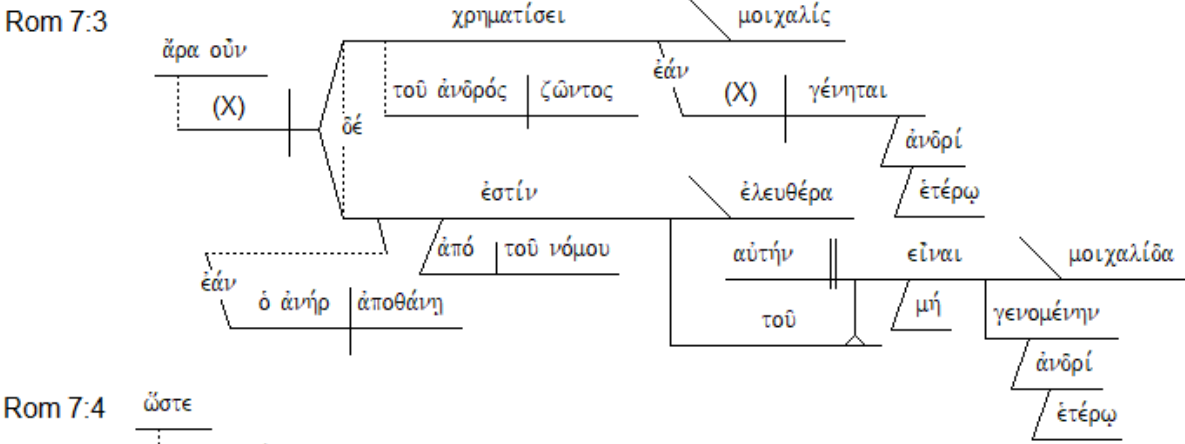
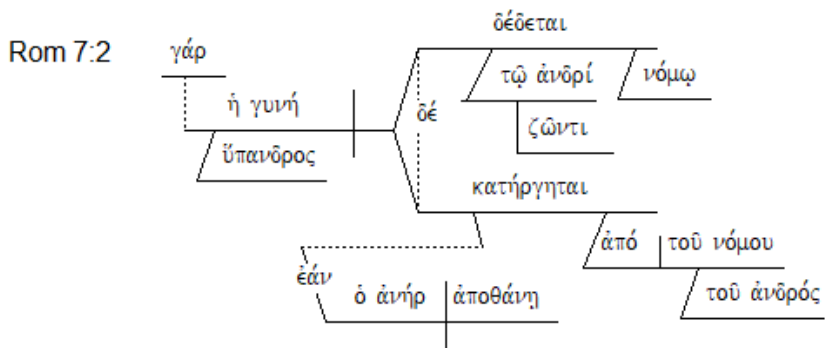
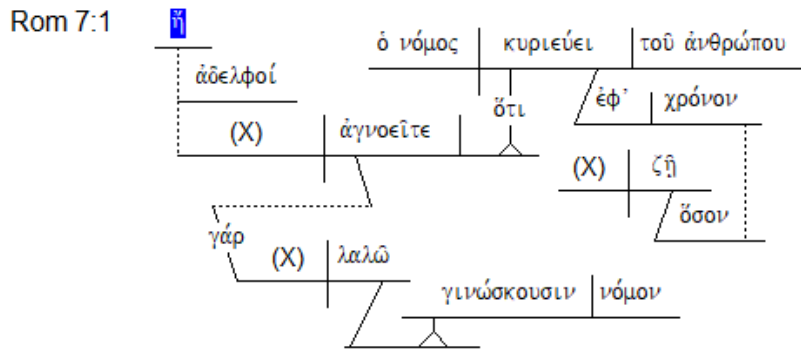

Rom 7:5-6

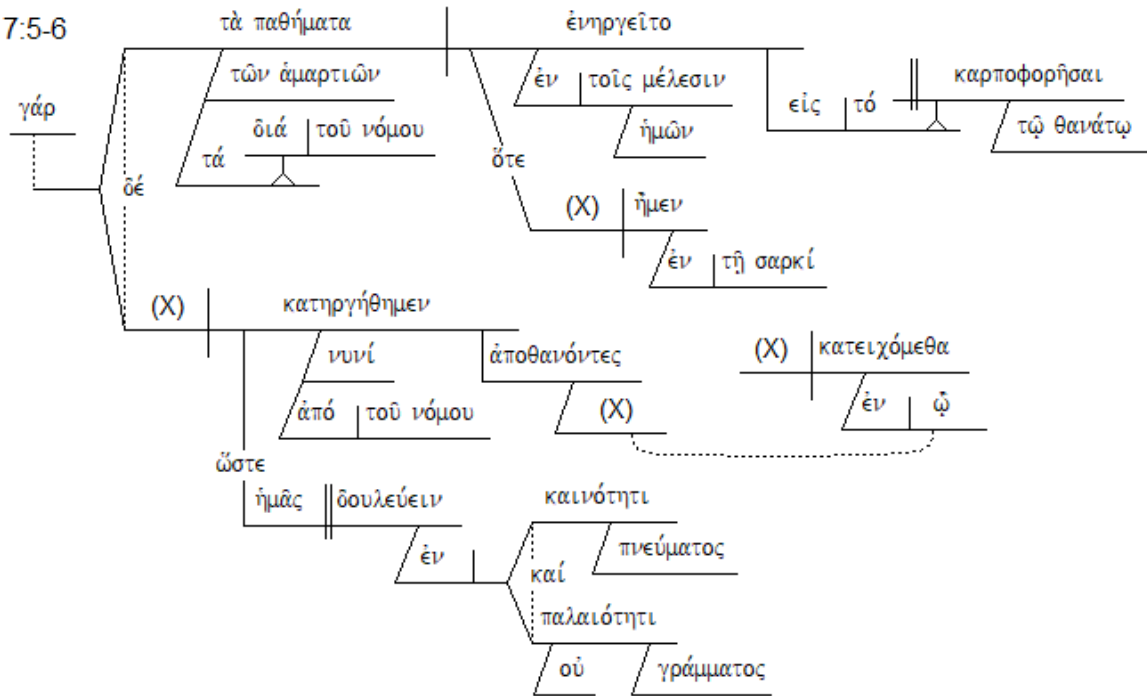

Frank Thielman:

1 Rhetorical Question Content Manner Duration	Or are you unaware , brothers and sisters (for I speak to those who know the law), that the law rules as lord over a human being as long as he or she lives?
2a Explanation (of 1)	For the married woman is bound by law to her living husband,
b Contrast	but if her husband should die, she is released from the law as it concerns her husband.
3a Condition Inference (from 2a–b)	So then, if she should become another man's while her husband is living, she is styled an adulteress.
b Contrast	But if her husband should die, she is free from the law
c Result Concession	so that she is not an adulteress although she should become another man's.
4a Inference (from 1–3)	So, my brothers and sisters, you too have been put to death with respect to the law through the body of Christ— the one who was raised from the dead— in order that you might become another's that we might bear fruit for God.
d Purpose (of 4a) e Purpose (of 4d)	
5a Time (of 5b)	For
b Explanation (of 4)	the sinful passions that were prompted through the law used to work in our members
c Result (of 5b)	when we were in the flesh, so that we bore fruit for death.
6a Contrast (to 5)	But now we have been released from the law,
b Cause (of 6a)	having died to that by which we used to be held captive
c Result (of 6a–b)	so that we serve in the newness of the Spirit and not
d Contrast	in the oldness of the letter.

TEXT: ROMANS 7:7-12

TITLE: DON'T BLAME GOD – THE LAW IS NOT SINFUL

BIG IDEA:

**ALL THE BLAME FOR SIN FALLS ON OUR SINFUL NATURE,
NOT ON GOD'S LAW WHICH REMAINS GOOD**

INTRODUCTION:

Frank Thielman: The close association between the law, sin, and death in Paul's argument up to this point does not mean that the law, like sin and death, is evil. The law is God's word and therefore is completely good. However, the law has no power to overcome sin in the weak, sin-prone human being, and in the face of sin's power it becomes a tool by which sin deceives the human being into persistent disobedience to God.

S. Lewis Johnson: Now a thoughtful listener to the Apostle Paul, there are occasionally thoughtful listeners even on Sunday morning in the eleven o'clock service. They may have thought something like this. Now Paul you just said in chapter 6 that the believer has died in respect to sin, and now in **chapter 7** the believer has died with respect to the law. If the believer has died with respect to sin, he had died with respect to the law are you not, Paul, putting the two in the same category? Are you not saying that the law stands in the same category that sin stands in? Is God's law sinful?

John Toews: Paul has drawn a series of contrasts, especially in **5:20-7:6**, in which the law is consistently linked with Sin or evil rather than with the grace and righteousness of God

Such an analysis is very problematic for a Jew. The law is the great revelation and gift of God, so how can it consistently be linked with Sin? How can Paul include the law among the powers arousing Sin and leading to sin and death? How is it possible to avoid the blasphemous conclusion that the law itself is Sin? Moreover, lurking behind that implication is a question about God. If the law is Sin(ful), then God is a fraud who tricked Israel by giving her evil in the name of good. Paul must respond to the implications of his analysis. **Romans 7:7 - 8:11** is his response; it is his explanation of **5:20-21** and **7:5-6**. . .

Paul asks and answers two questions: is the law to be identified with Sin (**v. 7**) and is the law responsible for death (**v. 13**)? Each question is answered with the powerful negative, absolutely not, followed by an explanation of the reason for the negative answer.

Grant Osborne: vv. 7-25 – The Struggle Within

But where does the law fit into all this? In this section, Paul shows that the law is powerless to save sinners (**7:7-14**) and lawkeepers (**7:15-22**). Even a person with a new nature (**7:23-25**) experiences ongoing evidence of the law's inability to motivate him or her toward good. The sinner is condemned by the law; the lawkeeper can't live up to it; and the person with the new nature finds that his or her obedience to the law is sabotaged by the effects of the old nature.

Once again, Paul declares that salvation cannot be found by obeying the law. No matter who we are, **only Jesus Christ can set us free**. Yet the law, because it is God's law, is not then cast aside as useless. In the next chapters, Paul grapples with the complexity of life under grace and the believer's relationship to God's law.

I. (:7-8) GOD'S LAW BENEFITS US BY EXPOSING AND PROVOKING OUR SINFUL NATURE

A. (:7a) Rejection of False Inference that the Law is Sin

1. Objection Raised

"What shall we say then? Is the Law sin?"

Frank Thielman: The expression "*what shall we say?*" (3:5) or "*what, then, shall we say . . . ?*" (4:1; 6:1; 7:7; 8:31; 9:14; 9:30) is a characteristic feature of Romans, where it is part of the dialogical, question-answer style that carries the argument of the letter forward. Paul uses it three other times in the same way he uses it here, to introduce a false inference from the preceding argument, an inference that he then rejects with his characteristic expression, "*certainly not!*" (3:5-6; 6:1-2; 9:14).

2. Outright Rejection

"May it never be!"

B. (:7b) Role of the Law is to Expose Sin

1. Summary Statement of the Positive Role of the Law

"On the contrary, I would not have come to know sin except through the Law;"

Illustration: The law is like a **microscope** that shows us a realm of reality (sin) that otherwise we could not see; Exposing our sinful nature

Douglas Moo: The Mosaic law helped him come to understand clearly the extent and seriousness of his sin. . .

The best explanation, then, finds Paul in these verses to be describing the experience that **he and all Jews** have gone through as part of the people of Israel. Jews in Paul's day had a lively sense of their involvement with the great acts in the history of Israel. It would be natural for Paul to merge his own experience relative to sin and the law with the experience of his people Israel. As he has made clear throughout Romans, the coming of the commandment (= the giving of the law of Moses) meant for Israel not "*life*" but "*death*." Their sin was exposed and magnified, and greater wrath came on them (4:15; 5:20). . .

As most scholars today recognize, the style of **Romans 7** requires that "*I*" include reference to Paul himself. But I do think the **corporate** way of thinking so typical of Paul's world opens the way for us to take seriously the possibility that in this chapter he is not always referring to experiences from his own personal life but to experiences he has had in solidarity with his people Israel.

Bob Deffinbaugh: To think the Law to be sinful is like calling an x-ray evil, simply because it has some kind of relationship to cancer. An x-ray is good and beneficial simply because it exposes what is fatal to man if not dealt with. So, too, the Law exposes sin in man, which must be dealt with through the blood of Jesus Christ.

2. Specific Example

“for I would not have known about coveting if the Law had not said, ‘You shall not covet.’”

C. (:8) Reaction to the Law is the Activation of Sin

1. Specific Activation of Coveting

“But sin, taking opportunity through the commandment, produced in me coveting of every kind;”

Illustration: Law functions like 2 **magnets** with opposite polarity -- Provoking our sinful nature

Frank Thielman: Sin took advantage of the opportunity that God’s word afforded to suggest to people that rather than trust God’s word they should do what was in their own best interest according to their own judgment.

R. Kent Hughes: But the Law not only reveals sin, it activates sin, as **verses 8, 9** teach. . . An expanded **paraphrase** of this statement may be helpful:

“But sin, setting up a base of operations through the commandment not to covet, produced in me coveting of every kind; for apart from the Law sin is dead or dormant. And I was alive, blissfully indifferent, to the searching demands of the Law; but when the commandment not to covet came, sin sprang to life, and I felt the sentence of death.”

Have you considered what would happen if on Main Street of your town one of the stores painted this sign on its window: **YOU ARE FORBIDDEN TO THROW STONES THROUGH THIS WINDOW**. The window would not last twenty-four hours. Even human law’s prohibitions are to us like shaking is to a can of cola.

Grant Osborne: Why Do God’s Laws Arouse Our Sinful Desires?

Because sin in us seizes the opportunity and becomes:

- a sharpshooter, picking the best time and place for a kill
- a magnet, creating an attraction as the object comes near
- a temptress, working seduction at the point of need
- a lawyer, trapping a victim in his own arguments
- an engineer, building elaborate traps
- an army, occupying undefended areas in our morality
- a guerilla, instigating rebellion behind the scenes

Paul deliberately chose the last commandment as an example. That particular commandment was unique among the laws in the decalogue, and it obviously had a significant effect on Paul himself. The tenth commandment focuses entirely on our **inward nature**. At a superficial level, we may claim to have lived up to the first nine, but the last commandment exposes our intentions

with shameful clarity. Paul claims that no sooner had he discovered that commandment than “*every kind of covetous desire*” (7:8) assaulted him. His “*sinful passions*” (7:5) suddenly became clear. In telling him not to covet, the law had introduced Paul to the darkest desires. But still Paul could maintain his firm belief that **God’s law itself was sinless**. The bright light that revealed a world of filth was not itself evil for having done so.

2. Summary Statement of the Provoking Activity of the Law
“*for apart from the Law sin is dead.*”

Frank Thielman: When Paul says that apart from the law sin lies dead, he does not mean that people only sin in the presence of the law. Rather, he means that sin does not have the opportunity to generate knowing, willful rebellion against God and his word apart from the law (cf. 4:15; 5:20).

II. (:9-11) GOD’S LAW RESULTS IN DEATH BUT THE DECEITFULNESS OF SIN IS TO BLAME

A. (:9) The Law Replaces Spiritual Complacency with the Reality of Death

1. Spiritual Complacency Apart from the Law

“*And I was once alive apart from the Law;*”

2. Devastating Reality of Death

“*but when the commandment came, sin became alive, and I died;*”

Grant Osborne: The other issue in this extended passage (7:9-25) is its **timing in Paul’s life**. In this verse, written in **past tense**, the events clearly precede conversion. Within a few verses, however, Paul shifts to the **present tense**. In this case, the term tense is particularly appropriate, since **Paul reveals himself to be a person intimate with soul agony**. We should listen carefully to what Paul says, within the context that he says it, before we allow theological priorities to shift our understanding.

John MacArthur: Thirdly, it not only reveals the sin and rouses and aggravates the sin that’s in him, but **it devastates and destroys him**. **Verse 9**, he says, “*I was alive apart from the law once.*” Here, he doesn’t mean spiritually alive. He means **I was doing fine**. I was really living. I mean, I was going along in my complacent, unperturbed, self-righteous life. Everything was fine. I was just doing real well and all of a sudden this convicting upheaval when I was exposed to the law showed what sin really was. **Verse 9** says, “*When the commandment became clear to me, sin came to life and I was devastated. I died.*” What do you mean you died? “I died in the sense of all my hopes and all my dreams and everything I counted on and everything I hoped in were shattered and destroyed and ruined and devastated.”

This is again the loss of all security, the loss of all self-esteem, the loss of all self-satisfaction, the loss of all sense of self-preservation, the loss of all ability to think you could save yourself. I was devastated when I saw the real extent of God’s law and knew my own sinfulness. So, sin ruins, it devastates. And what Paul is saying when he says, “*I died,*” is this, I was broken in spirit. I was contrite. I was repentant. I was poor in spirit. I was mourning over my sin. I

was meek before God. If you want it in the terms of **Romans 5:6**, “*I was without strength. I was ungodly. I was –* ” in the terms of Jesus, “*- in need of a physician.*” And Paul has come to the point in his own life here that he is really looking for a way out of this horrendous guilt since being exposed to the law.

B. (:10-11) The Law Results in Death

1. (:10) The Law’s Intention Has Been Reversed in its Outcome (from Life to Death)

“and this commandment, which was to result in life, proved to result in death for me;”

Frank Thielman: To paraphrase **3:19**, the commandment stopped Paul’s mouth and held him accountable to God. Paul did not realize this at the time that he became aware of God’s commandment (**Phil 3:4–6**) but understood it later through the lens of the gospel. This is the force of the passive verb “*was found*” (εὑρέθη), which means that the truth about his spiritual death was revealed to him by God in the gospel.

2. (:11) The Law Results in Death Due to the Deceitfulness of Sin

“for sin, taking opportunity through the commandment, deceived me, and through it killed me.”

Frank Thielman: Just as the serpent deceived Eve by cleverly using God’s command to distort God’s character and good intentions toward his creation, so sin uses God’s command to generate human rebellion against God with its inevitable consequence of death. . . It is hard not to think of sin as lying dormant, waiting for its opportunity to strike and then finding the perfect moment to ambush its prey when the commandment came. This fits perfectly with the picture of the “crafty” (arum) serpent deceiving Eve in **Genesis 3:1–6**.

Grant Osborne: Sin deceives people by misusing the law. It is filled with false promises and deceptions:

- Sin promises to satisfy our desires even more than the last time.
- Sin promises that our actions can be kept hidden, so no one will know.
- Sin promises that we won’t have to worry about consequences.
- Sin promises special benefits: wisdom, knowledge, and sophistication.
- Sin promises power and prestige in exchange for cooperation.

Don’t buy the lie.

III. (:12) CONCLUSION: REGARDLESS OF HUMAN ABUSE, GOD’S DIVINE LAW REMAINS GOOD

“So then, the Law is holy, and the commandment is holy and righteous and good.”

Frank Thielman: the law is not sin but only sin’s tool and that the law, because it defines sin clearly, is entirely on the side of a holy, just, and good God.

John Toews: So that (*hōste*) introduces a **conclusion**. Paul has differentiated Sin and the law. **The problem is Sin, not the law.** The law was not able to give Israel a realm where the power of

Sin could not operate. In Eden and at Sinai the law provided Sin a leverage with which to push every Israelite into the force field of Sin. The conclusion, and the answer to the question in v. 7, is that the law is absolved of any responsibility for Sin. The law is not Sin. Rather, it is holy; it comes from God. Paul could hardly use a stronger theological word to affirm the law. It participates in the very nature of God, and is what Israel is to be before God. And the imperative quality of the law, the commandments, share the attributes of the law. They are holy in origin, righteous in nature, and good in their effects. The law in whole and in part reflects the character of God. It is the opposite of Sin. The problem is that Sin is able to use it against its nature.

Grant Osborne: If the law causes so much difficulty, what useful purpose does it serve?

- (1) It is a revelation of the nature, character, and will of God.
- (2) Its ethical components were incorporated in Christ's teaching.
- (3) It teaches us about sin.
- (4) It demolishes self-righteousness.

* * * * *

DEVOTIONAL QUESTIONS:

- 1) What value does the Mosaic Law (especially the Ten Commandments) hold for believers today?
- 2) What are some examples where you see specific laws or prohibitions actually spark an increase in lawbreaking?
- 3) How does the Holy Spirit work to bring about conviction and bring people to the place of spiritual bankruptcy so that their spiritual complacency is devastated and they are prepared for the message of the gospel?
- 4) How deceitfully does sin operate in your life and how can you combat it?

* * * * *

QUOTES FOR REFLECTION:

Frank Thielman: The Law is Good (7:7–12)

- a. The law makes sin known by defining sin as rebellion against God (7:7)
- b. The law makes sin known by prompting rebellion against God (7:8)
- c. The law's role in prompting sin is sin's fault, not the fault of the law (7:9–11)
- d. Conclusion: the law is holy, just, and good (7:12)

John Toews: The nature of Sin is defined as covet or desire (*epithymia*). This understanding of Sin was consistent with a widespread notion in the ancient world that desire was the root of all evil. As noted already, such a summation of the law was current in Judaism (see 4 Macc. 2:6; Philo, Decal., 142ff.). One word can say so much because the term used for covet covers more

territory than the English word. It includes idolatry, sexual sin, tempting God, and murmuring (see Paul's definition of it in relation to Israel in **1 Cor. 10:6-10**). Covetousness was the form of Sin for Satan and Adam in the Garden, and for Israel in its history with God. The law **exposes Sin** by defining boundaries for human life. It gives Sin a **military base of operations** from which to attack people and nurture covetousness. Sin and law are differentiated, but also related. **Sin is able to make an ally of what was intended as its enemy.**

Steven Cole: Why God Gave the Law

God gave His law to convict us of our sin and bring us to the end of ourselves so that we would flee to Christ for salvation.

Our innate self-righteousness is so entrenched that until the law strips us of it and convicts us of our sin, we will not cast ourselves totally upon Christ. Our culture adds to this by telling us that we're not sinners. We're not *worms*, for goodness sake! We're pretty good folks. We may want to bring Jesus into our lives as a useful coach or helper in our self-improvement program. But to trust Him as our Savior, we have to see the depth of our sin as God's law exposes it for what it is. That's what Paul describes here.

1. The law is not sin, but it does reveal our sin (7:7).

2. The law provokes sinners to sin (7:8).

Paul personifies sin as an active force that uses the law to provoke us to commit acts of sin. By *sin*, Paul means sin as a principle and power, not just acts of sin (**Lloyd-Jones**, p. 120). He repeats the phrase again (**7:11**), "*sin, taking opportunity through the commandment.*" *Opportunity* was a word used for a military base of operations from which the army launched its campaigns. So sin takes God's holy commandments and uses them to tempt us to violate those commands. It stirs up the rebel in us and makes us want to assert our right to do as we please.

3. The law, through our failures to keep it, brings us to the end of ourselves (7:9-11).

Some say that **verse 9** refers to Adam, since he is the only one of whom it rightly could be said that he was once alive apart from the law. Others take it to refer to Israel before the law was given. But most likely, Paul is speaking in a relative sense about **his own perception of himself**. Once, he thought that he was alive and doing quite well in God's sight. He saw himself as blameless with regard to the righteousness of the law (**Phil. 3:6**). Like the Pharisee in Jesus' story, he would have prayed (**Luke 18:11-12**), "*God, I thank You that I am not like other people: swindlers, unjust, adulterers, or even like this tax collector. I fast twice a week; I pay tithes of all that I get.*" In that sense, Paul saw himself as once alive apart from the law. He was "*apart from the law*" in the sense that it had not yet bore down on his conscience to convict him on the heart level. . .

At first, Paul thought that he was alive and sin was dead. But then, God's law hit him and he suddenly realized that his sin was very much alive and he was dead. He saw that he was not right with God, as he formerly had thought. Rather, he was alienated from God and under His

judgment. He had thought that he would get into heaven because he was a zealous Jew, and even a notch above other Jews, because he was a Pharisee. But now he realized that he was a blasphemer, a persecutor of God's church, a violent aggressor, and the chief of sinners (**1 Tim. 1:13, 15**).

David Thompson: When it comes to facing our own sin or dealing with our own guilt, there are basically two things we can do:

1. We can deal with it directly and honestly before God.
2. We can deal with it defensively by excusing it within ourselves.

People have a tendency to blame others for their sin.

- 1) Adam was a victim ... he blamed Eve (**Genesis 3:11-12**).
- 2) Eve was a victim ... she blamed Satan (**Genesis 3:13**).
- 3) Cain was a victim ... he blamed ignorance (**Genesis 4:9**).
- 4) In James' day, some believers were victims and blamed their circumstances that had been ordained by God (**James 1:13-14**).
- 5) In Paul's day, some believers were victims and blamed God's Word.

ALTHOUGH GOD'S LAW DOES SHOW US OUR SIN, GOD'S LAW CANNOT BE BLAMED FOR OUR SIN.

There are no victims when it comes to sin. We have all sinned, we have all gone astray and we are all guilty. There is no point running from all this for this is reality.

Now the basis for Paul's discussion is found in the first part of **verse 7**. Paul says, "May we never dare accuse God's Word or God's Law of being the reason for our sin problem.

He is going to set forth three main theological purposes of the Law:

THEOLOGICAL PURPOSE #1 – The Law gives us knowledge of our own sin . 7:7b

The Greek word "*know*" is one that means to have understanding. The idea is that the Law of God gives us an understanding of when and how we sin.

THEOLOGICAL PURPOSE #2 – The Law brought our own sin to life. 7:8

The word "opportunity" is a military term. When war broke out, the Romans would establish some spot as a military base for their operations. It was this place that became the headquarters of all military activity. Paul is saying this - God's commandments are the base headquarters for revealing sin. Apart from the Law sin was dead in that it was not clearly identifiable.

THEOLOGICAL PURPOSE #3 – The Law brought us the reality of death. 7:9-11

Leedy Greek NT Diagrams:

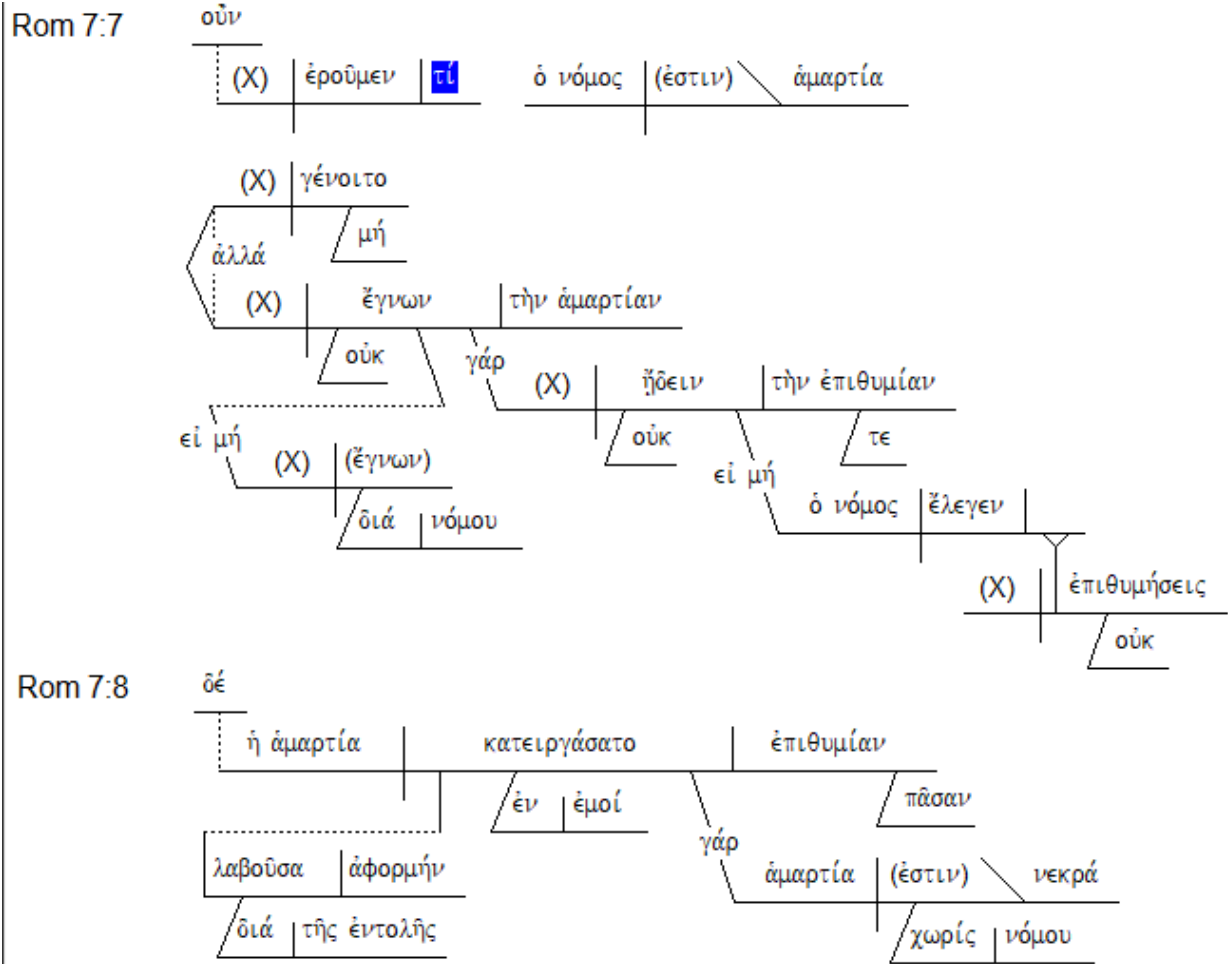

Rom 7:9-11

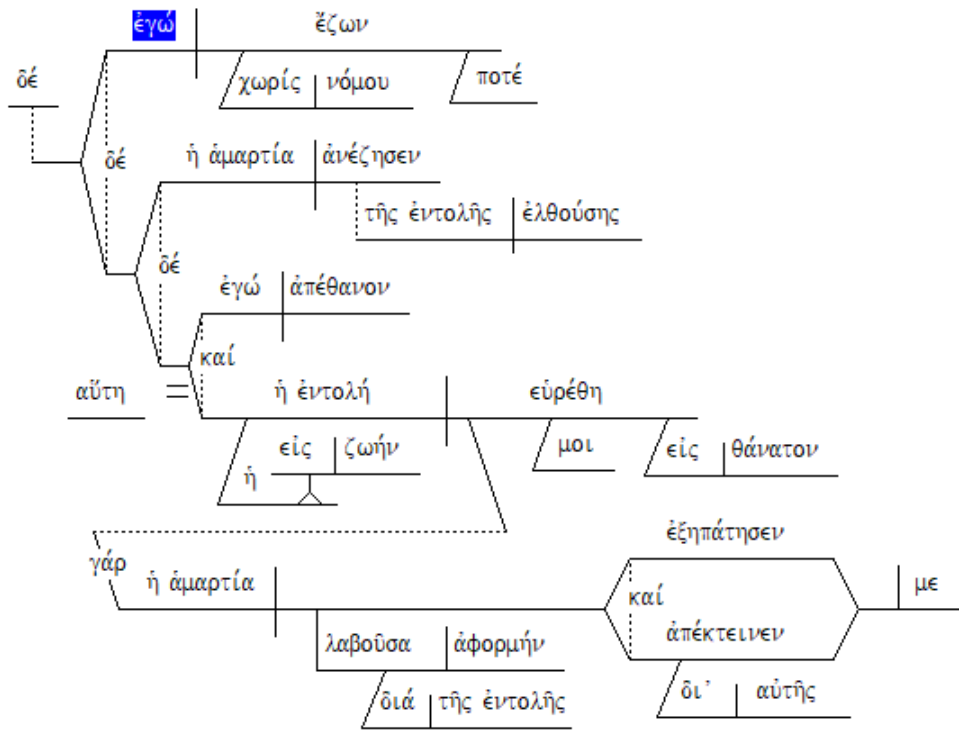

Rom 7:12

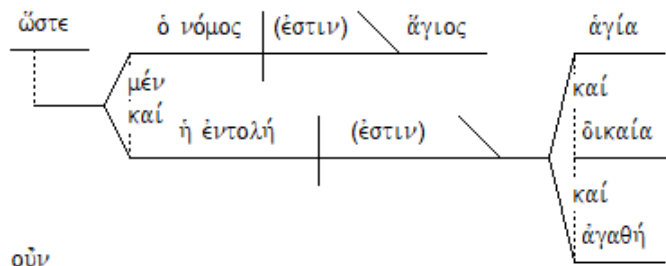

Rom 7:13

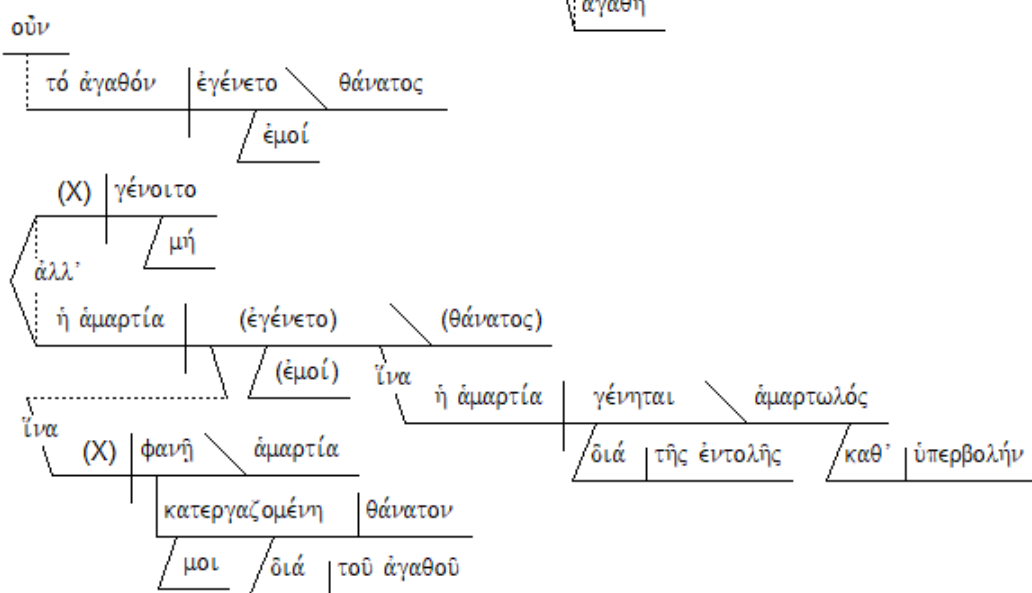

Frank Thielman:

- 7a Rhetorical Question **What, then, shall we say?**
b Rhetorical Question **Is the law sin?**
c Exclamation **Certainly not!**
d Explanation On the contrary, **I would not have known sin**
e Condition except through the law.
- f Illustration **Indeed, I would not have known coveting**
g Condition unless the law had said, "You shall not covet."
(Exod 20:17; Deut 5:21)
- 8a Expansion And **sin,** taking its opportunity, through the commandment
... **produced in me all manner of coveting.**
- b Explanation/Separation For apart from the law,
Assertion **sin is dead.**
- 9a Explanation **And I was once living**
b Separation apart from the law,
c Sequence but when the commandment came
sin revived.
- 10a Simultaneous **But I died,**
b Conclusion and **the commandment** whose purpose was life—
this, for me, was found to result in death.
- 11a Restatement (of For **sin,** taking its opportunity,
10a–b) ... **deceived me through the commandment**
- b Assertion and through it
killed me.
- 12a Conclusion/Summary So, **the law, for its part, is holy,**
b Restatement and **the commandment is holy and**
c List **just and**
d List **good.**
- 13a Rhetorical Question **Did that which is good, then, become death for me?**
b Exclamation **Certainly not!**
c Explanation On the contrary, **sin, so that it might be shown to be sin, was producing death in me**

TEXT: ROMANS 7:13-25

TITLE: WRESTLING WITH SIN – THE HOPE AND STRUGGLE FOR CHRISTIANS

BIG IDEA:

THE CHRISTIAN LIFE IS A CONSTANT STRUGGLE WITH SIN INVOLVING CONTRADICTION, TENSION AND CONFUSION BUT WITH THE SURE HOPE OF COMPLETE DELIVERANCE THROUGH CHRIST

INTRODUCTION:

There has been much disagreement down through church history regarding the interpretation of this text. Is Paul talking about his own experience as a believer or something else? How can a believer describe himself as “*I am of flesh, sold into bondage to sin*”? Yet, if we are honest, the more mature we are as a Christian we must acknowledge that the reality of our experience certainly meshes with the tension and conflict that Paul describes here. That does not mean that we do not experience victory through our Lord Jesus Christ in the process of sanctification. I tend to follow the line of interpretation taken by **Dr. John MacArthur** who sets forth the controversy as follows:

That is a poignant description of someone in conflict with himself, someone who loves God’s moral law, someone who deep down in his innermost self wants to obey God’s moral law, but is pulled and pushed away from its fulfillment by sin, sin that is in him. It is the personal experience of a soul in conflict. It is a battle. It is a warfare that rages in the heart. The conflict is very real. It is very intense. It is very strong. Of that there is no mistake.

It finds its summation in **verse 25** - or **verse 24** - “*O wretched man that I am.*” There is a wretchedness about this battle. There is a wretchedness about this conflict. And then the cry, “*Who shall deliver me?*” And then the affirmation. “*I thank God through Jesus Christ our Lord.*” But even knowing that, it concludes, “*So then, with the mind I myself serve the law of God; but with the flesh the law of sin.*”

Now some people say this is a Christian being described. And some people say this is a non-Christian. And people have been saying those two things ever since **Romans 7** was written. Whole movements have depended for their very life on the interpretation of **Romans 7**. One side says there is too much bondage to sin for a Christian. The other says there’s too much desire for good for a non-Christian. You can’t be a Christian and be bound to sin and you can’t be a non-Christian and desire to keep the law of God. And therein is the conflict of interpreting the passage.

<https://www.gty.org/library/sermons-library/45-52/the-believer-and-indwelling-sin-part-1>

David Thompson: I am totally and completely convinced that **Romans 7:13-24** is unequalled in its ability to produce spiritual victory in our lives and it is critical that we understand these verses very carefully. This text is one of the most controversial texts in the entire book of Romans.

The big controversy is this: Is Paul describing himself when he was spiritually unsaved? Is Paul describing himself when he had a struggle with fleshly carnality? Is Paul describing himself at a time when he came under conviction? Is Paul describing himself as a very spiritual and mature believer?

Those who believe Paul is describing an unsaved man do so on the basis that he says “*he is sold into bondage to sin*” (v. 14), that “*nothing good dwells in me*” (v. 18), and finally says “*wretched man that I am*” (v. 24). However, the biggest grammatical argument against this is that in **verses 7-13** the verbs are **aorist** and in **verses 14-24** the verbs are **present tense**, describing Paul’s present, continuous experience.

Those who believe Paul is describing a carnal Christian, who is dominated by the flesh, do so on the basis of the argument, that what we see here in this context is nothing but a defeated Christian who talks about his flesh problem (vv. 14, 18). However, if the context is carefully studied it is clear, that according to **verse 25**, Paul learns where victory is found - in one’s life through Jesus Christ and through the Holy Spirit (**Romans 8**).

Those who believe Paul is describing a man under conviction do so on the basis of the fact that Paul does not seem to describe one lost or one saved, but one in a state of conviction. The real problem with this is that one is either lost or saved. Again, Paul uses present tense verbs which indicate this is a continual situation, not a temporary moment of conviction.

We are far better to assume that Paul is writing these things and a very mature and spiritually minded apostle. This was the conviction of Augustine, Luther, Calvin and most of the serious Bible interpreters. Paul is describing the struggle of the Christian life and he will show where victory is found.

Now there is nothing easy about victory in the Christian life; it is a struggle. You will not be able to go to some weekend seminar and come out victorious. You will not be able to have some peak spiritual experience and defeat your flesh. You must be a spiritual realist like Paul. You must be able to spot sin, and one thing you must know if you are to have victory, is that you will not get it from the O.T. Law. The one thing you must understand is this:

THE LAW OF GOD IS NOT DESIGNED TO MAKE ONE SPIRITUAL, IT IS DESIGNED TO SHOW ONE IS SINFUL AND, THEREFORE, ONE WHO TRIES TO BE SPIRITUAL BY KEEPING THE LAW WILL BE ABSOLUTELY MISERABLE.

John Murray: The person portrayed in **7:14-25** is one whose will is toward that which is good (vvs. 15, 18, 19, 21) and the evil that he does is in violation of that which he wills and loves (vss. 16, 19, 20). This means, without doubt, that his most characteristic will, the prevailing bent and propension of his will, is the good. And this again is totally unlike the unregenerate man of **8:5-8**. The man of **7:14-25** does bad things but he hates them and they violate the prevailing bent of his will to the good.

Bruce Hurt: This section has been one of the most controversial in the New Testament. The majority of commentators (e.g., John MacArthur, John Piper, Warren Wiersbe, S Lewis Johnson, Robert Mounce, Harry Ironside, Donald Barnhouse, Albert Barnes, William MacDonald, Martin Luther, John Calvin, Melancthon, Beza, John Owen, Delitzsch, Hodge, Shedd, Kuyper, F F Bruce, and C E Cranfield, et al) favor this to be a description of a regenerate man (Paul) wrestling with the sinful propensities still present in his mortal body as it is in every saved person.

Steven Cole: We need to keep in mind that Paul’s main purpose is not to share this as an interesting story, but rather to establish the holiness and integrity of the law, while at the same time to show the law’s inability to deliver us from sin. To have consistent victory over sin, we must learn to rely moment by moment on the power of the indwelling Holy Spirit, which Paul explains in **chapter 8**.

I. (:13) THE BLAME FOR OUR DEATH FALLS NOT ON THE LAW, BUT ON THE AWFULNESS OF OUR SINFUL NATURE – WHICH THE LAW EXPOSES

A. Death Cannot Be Blamed on the Law

1. Absurd Inference

“Therefore did that which is good become a cause of death for me?”

2. Outright Rejection

“May it never be!”

B. Our Sinful Nature Deserves All the Blame

“Rather it was sin, in order that it might be shown to be sin by effecting my death through that which is good, that through the commandment sin might become utterly sinful.”

Frank Thielman: The verse serves a **transitional function** between **7:7–12** and **7:14–25**. Like **7:7–12** it is set in the past (“*did that which is good . . . ?*”), and the rhetorical question with which it begins arises naturally out of Paul’s statement that sin “*killed*” him “through the commandment” (**7:11**). At the same time, however, its claim that sin became “*extremely sinful*” and its mention of the “*death*” that sin “produced” (κατεργαζομένη) in the individual anticipate the major themes and vocabulary of **7:14–25** (cf. especially **7:15, 17, 18, and 20**). . .

The substance of the sentence is that sin rather than the good commandment was the cause of the individual’s death, and so the commandment is exonerated from blame for the death of the individual. With the two purpose clauses and the passive-voice verbs they contain, however, Paul addresses the deeper question of how, in a world that God oversees, sin could get away with using the law this way. Paul answers this implied question with a principle he has already articulated in **3:20, 4:15, 5:13, and 5:20**. **Sin did not steal the law from God and use it contrary to God’s intentions.** Instead, the close association between the law and sin **fulfilled one of God’s purposes in giving the law.** When the law came into contact with human sin, it revealed sin’s true nature as a deceptive force that tricks people into disobeying God and thus suffering the inevitable consequence of death (cf. **Gen 3:1–6**).

John Toews: The law creates death by drawing boundaries which people cross. The second purpose of the law intensifies the first. The law serves to make Sin sinful to an extraordinary degree. It demonstrates the real character of Sin and its consequences, death. At precisely the time that Sin appears to have conquered the law, the law proclaims God's will. It fulfills the divine purpose by revealing the radical sinfulness and awful result of Sin.

Ray Stedman: to expose the fact that this evil force (Sin) is in every one of us, waiting only for the right circumstance in order to spring into being (cf. God's warning to Cain "*sin is crouching at the door; and its desire is for you, but you must master it.*" **Ge 4:7b, cp Ge 4:6, 8**), overpower our will and carry us into things we never dreamed we would do. Many of us experience this. According to this passage, the great power of sin is that it deceives us (**Ro 7:11**-note). We think we have got life under control -- and we are fooled. All sin is waiting for is the right occasion (**Ro 7:8, 11**-notes **Ro 7:8; 7:11**) when, like a powerful, idling engine, it roars into life and takes over at the touch of the accelerator and we find ourselves helplessly under its control. (*The Continuing Struggle*)

II. (:14-23) THE CHRISTIAN'S STRUGGLE INVOLVES CONTRADICTION, TENSION AND CONFUSION – 3 LAMENTS

Not speaking about the universal Human Struggle here; this struggle only applies to Christians; not talking about weak believers; in fact the more mature the Christian, the more he is aware of his utter sinfulness and of the struggle being waged between the Spirit and the flesh. (Therefore, the presence of the struggle itself should be an encouragement that one is a believer.) **The key here is that you cannot become spiritual by keeping the law.**

A. (:14-17) Lament #1 – Wrestling with Contradiction

1. :14) The Condition: Constant Struggle between 2 Opposing Forces

- a. The Spirit – Represented Here by God's Righteous Law
"For we know that the Law is spiritual;"

Warren Wiersbe: Our nature is carnal (fleshly), but the law's nature is spiritual. This explains why the old nature responds as it does to the law. It has well been said, "The old nature knows no law, the new nature needs no law." The law cannot transform the old nature; it can only reveal how sinful that old nature is. The believer who tries to live under law will only activate the old nature; he will not eradicate it.

- b. The Flesh – Our Old Sin Nature that Still Plagues Us
"but I am of flesh, sold into bondage to sin."

How can a believer who is dead to sin still function at times as if he is very much alive to sin? Cf. the illustration of a chicken with its head cut off but still acts very much alive.

William R. Newell: This is slave-market talk: and it describes all of us by nature. Instead of being spiritual and therefore able to harken to, delight in and obey God's holy, spiritual Law, we

are turned back, since Adam sinned, to a fleshly condition, our spirits by nature dead to God, and our soul-faculties under the domination of the still unredeemed body (Romans, p. 292).

David Thompson: Paul is talking about a mature believer here. A new convert does not know this. A new convert or an immature believer knows that his sins are forgiven and that he is justified by faith and is joyful about that. But the new convert does not know that there is an evil nature that will soon raise its ugly sinful head and will rebel against God and pursue its own path.

The more spiritually minded we become, the more we will realize the goodness and holiness of God and the worthlessness of ourselves. We will more and more realize our need to depend on God's grace and less and less depend on our works or attempts at keeping the Law.

John Murray: Paul recognizes that the flesh still resides in him (vss. 18, 25). This is closely associated if not synonymous with the fact that sin dwells in him (vss. 17, 20). If the flesh still dwells in him, it is inevitable that in respect of the "flesh" in him he should be called "fleshly", and it is not inconsistent with his being regenerate that he should so characterize himself because of the flesh which is still his.

2. (:15-16) The Proof of that Condition

"For that which I am doing, I do not understand; for I am not practicing what I would like to do, but I am doing the very thing I hate. 16 But if I do the very thing I do not wish to do, I agree with the Law, confessing that it is good."

David Thompson: I want to point out the verb, "I do." This is a key verb of this section. It appears in four verses - 15, 17, 19, and 20. The Greek verb (κατεργαζομαι) is one that literally means to **achieve through labor** (G Abbott-Smith, Greek Lexicon, p. 240). In this context it means to attempt to achieve through labor the works of the Law.

Paul is saying that he kept trying, by his own works, to keep the perfect Law of God and couldn't understand why he could not do it. He wanted so desperately to have victory over sin, but he kept losing and doing the very thing he hated. This was a major theological concession for Paul because at one time he thought he could keep the Law blamelessly before God (**Philippians 3:6, 9**).

This verse combats two extreme faulty notions:

1. The possibility of sinless perfectionism.
2. The promotion of sinful antinomianism.

3. (:17) The Source of that Condition = Indwelling Sin

"So now, no longer am I the one doing it, but sin which indwells me."

B. (:18-20) Lament #2 – Wrestling with Tension

1. (:18a) The Condition = Nothing Good Dwells in My Flesh

"For I know that nothing good dwells in me, that is, in my flesh;"

James Stifler: This dirge does not advance the argument one step. It comes to the same conclusion as the last one and in the same terms – “*sin that dwelleth in me.*” But, while it does not advance, it emphasizes by becoming more specific. There he introduced the metaphor of a house: “*sin dwells in me.*” He now shows that sin occupies every room in the whole abode: “*there does not dwell in me a good thing.*” Sin lodges in every chamber from the cellar to the roof.

2. (:18b-19) The Proof of that Condition

a. (:18b)

“for the wishing is present in me, but the doing of the good is not.”

b. (:19)

*“For the good that I wish, I do not do;
but I practice the very evil that I do not wish.”*

3. (:20) The Source of that Condition = Indwelling Sin

*“But if I am doing the very thing I do not wish,
I am no longer the one doing it, but sin which dwells in me.”*

C. (:21-23) Lament #3 – Wrestling with Confusion

1. (:21) The Condition = Evil is Present in Me

*“I find then the principle that evil is present in me,
the one who wishes to do good.”*

2. (:22) The Proof of that Condition

“For I joyfully concur with the law of God in the inner man,”

3. (:23) The Source of that Condition = Indwelling Sin

*“but I see a different law in the members of my body,
waging war against the law of my mind,
and making me a prisoner of the law of sin which is in my members.”*

John Murray: When we ask how the evil can be present when there is the determinate will to the good, the answer resides in the fact that there are two antithetical laws, the law of God and the law of sin, both of which bear upon our persons and are therefore registered in us in a way that reflects the antithesis in which they stand to each other.

IV. (:24-25) NEVERTHELESS, THE CHRISTIAN LIVES WITH A CONFIDENT HOPE FOR COMPLETE DELIVERANCE THROUGH CHRIST

A. (:24) Cry for Deliverance

1. Wretched Condition

“Wretched man that I am!”

2. Desperate Plea

“Who will set me free from the body of this death?”

B. (:25a) Thanksgiving for Ultimate Deliverance

“Thanks be to God through Jesus Christ our Lord!”

David Thompson: What is the answer? Who is the answer? It is found in **verse 25**. Recognize that spiritual victory is not found by keeping the law; it is found in Jesus Christ. As long as a person tries to keep the law he will live in misery. But when one focuses on Jesus Christ, he can have a life of victory.

John Murray: This is the answer to the question of **vs. 24**, and it expresses triumphant assurance of ultimate deliverance from the body of this death and from the captivity to the law of sin which elicits the anguish of his complaint. The “heart-rending cry” cannot therefore be construed as one of despair; it must never be dissociated from the sequel of confident hope. What is in view in this thanksgiving? If “the body of this death” refers to the body through which the law of sin carries on its warfare, then no other interpretation suits the terms of the thanksgiving itself or the analogy of Paul’s teaching more adequately or relevantly than the assurance of the resurrection. That it parallels **1 Cor. 15:57**, where the hope of the resurrection is beyond question, is not by any means an unreasonable supposition. And what could be more relevant to the anguish which the exclamation expresses and to the consideration that the body is the body of the death alluded to than the assurance of the deliverance that will be wrought when the body of our humiliation will be transformed into the likeness of the body of Christ’s glory (**Phil. 3:21**) as that which believers groan and wait for (**8:23**)? It was not death that Paul longed for as the blessed hope but the deliverance bestowed when the corruptible will put on incorruption and the mortal immortality (**1 Cor. 15:4; 2 Cor. 5:4**). The terseness of the thanksgiving in no way unsuits it as the formula of eschatological hope. It brings to the forefront the power and grace of God and the mediation of Christ, the elements which makeup the essence of the hope to come.

C. (:25b) Reality of Continuing Struggle

1. The Spirit – Represented by the Law of God

“So then, on the one hand I myself with my mind am serving the law of God,”

2. The Flesh

“but on the other, with my flesh the law of sin.”

* * * * *

DEVOTIONAL QUESTIONS:

- 1) In what respects have you found your own Christian experience to mirror some of the tension and conflict reflected in this passage?
- 2) Why is it so dangerous to teach that Christians can mature to some type of spiritual plateau that rivals perfectionism?

3) How would you characterize the warfare between the flesh and the Spirit in your Christian experience?

4) How much are you impacted emotionally by your sin and your failures to consistently obey the Lord?

* * * * *

QUOTES FOR REFLECTION:

John MacArthur: The emphasis in **chapter 7** does not necessarily have to be the same as in **chapter 6**. And every Christian knows that even though he is new in Christ, and sin's dominion is broken, and sin no longer has mastery over him, **sin is still a problem**. And so whether or not you want to see a Christian in **chapter 7**, you've still got to see a Christian having conflict with sin even though his new creation, his new self is holy.

And that is why it's so important to understand what we taught in **chapter 6**, that that which is recreated is the new I. And that new redeemed self is holy. But there's still going to be a conflict. And whether you see that conflict in **chapter 7** or not, there is still a conflict, and it is pointed out, may I add, even in **chapter 6**. Notice **6:12**. "*Let not sin therefore reign in your mortal body, that you should obey its lusts.*"

Now wait a minute. You just said we died to sin, you just said that the sin - the body of sin, **verse 6** - was destroyed and we would henceforth not serve sin. Now why in **verse 12** are you commanding us not to let it reign? You see, **you have the same problem in chapter 6**. You still have to deal with the problem of the believer and sin. And in all that Paul said in **chapter 6** about our new nature, and our new creation, and our new essence, he never said that from then on we wouldn't have a battle with sin. **Verse 12** implies that sin could still have a reigning place. It could still be shouting out orders which we are submitting to. We could still be obeying sin. Follow into **verse 13**. "*Neither yield ye your members as instruments of unrighteousness unto sin.*" Which is to say you could do that. And so you have to be commanded not to do that. . .

The conflict here, the tension, the battle between what Paul says, "I delight in, I love, I approve, I want, I long to do," and that that he actually does, I believe, can only be true in a redeemed person. I don't really think in an unregenerate person, an unredeemed person, an unsaved person that there really is much of a battle at all. I mean, we don't believe for a moment that people without God are basically really good people who just can't seem to pull it off. We believe they're really evil people who act out the evil that's inside them. . .

You know **what kind of Christian** this is? My friend, this is the most mature spiritual Christian there could ever be, who sees so clearly the inability of his flesh as over against the holiness of the divine standard. You see? And the more mature he is, and the more spiritual he is, the greater will be the sensitivity of his own shortcomings. You show me an infantile, "carnal," fleshly, legalistic, self-righteous kind of Christian, and I'll show you somebody who lives under the disillusion that everything he's doing is really very spiritual. You show me a person with

this kind of brokenness, you show me a person agonizing in the depths of his own soul because he can't do everything written in the law of God, and I'll show you a spiritual person. . .

just as sin did not obviate the goodness of the law before he was saved, it does not obviate the goodness of the law after he's saved. The law reveals sin to be sinful before you're saved and it reveals sin to be sinful after you're saved. . .

So, while telling us that the law cannot save and the law cannot sanctify, he affirms that it is good, and holy, and just because it does convict of sin before you're saved and brings you to Christ and after you're saved so that you'll understand God's holy standard and long with all your heart to fulfill it. The problem is not the law. The problem is us. Pogo said it, "We have met the enemy and he is us."

David Thompson: vv. 19-25 -- THERE IS A WRETCHED SIN PRINCIPLE IN US THAT CAUSES US TO DO JUST THE OPPOSITE OF WHAT GOD'S LAW SAYS WE SHOULD DO, AND IN VIEW OF THIS, VICTORY WILL NEVER BE FOUND IN OURSELVES OR IN OUR WORKS.

There are moments when our new nature will prompt us to do one thing and our old nature will end up doing just the opposite. There are moments when your new nature will say don't gossip and then you'll gossip. There are times when your new nature will say don't lust and then you'll lust. There are times when your new nature will say don't covet and then you'll covet. There are times when your new nature will say you need to pray more and you won't do it. Paul discovered there were times when he did just the opposite of what he wanted to do.

F. F. Bruce: In a lecture on Paul's description of himself as being "sold under sin", **Dr. Alexander Whyte** said:

As often as my attentive bookseller sends me on approval another new commentary on Romans, I immediately turn to the seventh chapter. And if the commentator sets up a man of straw in the seventh chapter, I immediately shut the book. I at once send the book back and say "No, thank you. That is not the man for my hard-earned money."

What did he mean?

This, that Paul's poignant description in **verses 14-25** of someone who loves the law of God and longs to do it, but is forced by a stronger power than himself to do things which he detests, is no "abstract argument but the echo of the personal experience of an anguished soul" [**M. Goguel**]. Paul himself knows what it means to be torn this way and that by the law of his mind which approves the will of God, and the law of sin and death which pulls the other way.

The Christian, in fact, lives in two worlds simultaneously, and so long as this is so he lives in a state of tension. Temporally he lives in this world; as a man of flesh and blood he is subject to the conditions of mortal life; he is a "*son of Adam*", like all his fellow-men, and with them he is subject to the law that "*in Adam all die*." Spiritually, however, he has passed from death to life, from the realm of darkness to the kingdom of light; he has shared in Christ's death, burial and

resurrection, in which he has been raised “*to walk in newness of life*”, a citizen of the new world, a member of the new creation, no longer “*in Adam*” but “*in Christ*”.

The day will come when this present order will pass, when the new age will be established in glory, and then the tension between the two ages will be resolved. But so long as Christians live “between the times”, Paul’s words in another Epistle retain their full relevance: “*the flesh lusteth against the Spirit, and the Spirit against the flesh: and these are contrary the one to the other; so that ye cannot do the things that ye would*” (**Gal. v. 17**).

Here then is the self-portrait of a man who is conscious of the presence and power of indwelling sin in his life; it is a tyrant whose dictates he hates and loathes, but against whose power he struggles in vain.

Steven Cole: [Reviews the various views and comes to the following conclusion]

I understand the Christian life to be an ongoing, lifelong struggle against the world, the flesh, and the devil. We never arrive at a place in this life where sin no longer tempts us, where trials are not a difficult burden, and where we have attained sinless perfection. Jesus Himself cried out to God with loud crying and tears (**Heb. 5:7**). Paul was burdened so much that he despaired of life itself (**2 Cor. 1:8**). He describes his Christian life as a fight, not an effortless rest (**2 Tim. 4:7**). The author of Hebrews commends his readers in their *striving* against sin, and encourages them to submit to the difficult discipline of the Lord that for the moment does *not* seem joyful, but sorrowful (**Heb. 12:4-11**). So I’m not saying that in moving from **Romans 7** to **Romans 8**, life becomes an effortless, ecstatic experience of perpetual victory. Even mature believers fall into sin on occasions and they always fall far short of perfection.

This means that there is always going to be some degree of the struggle expressed in **Romans 7** in the Christian life, even in **Romans 8**. In that, I agree with those who argue that this is the experience of a mature Christian. As we grow to know God and His ways more deeply, we will always be painfully aware of how far short we fall. We will always lament our propensity toward living in the flesh and yielding to the sin that so easily besets us. There will always be the battle between the two natures. I do not agree with those who say that believers only have the new nature, or that we only sin occasionally. It is a daily battle with many setbacks.

But I disagree with those who argue that **Romans 7** describes the “normal” Christian life. The man in **Romans 7** is not just struggling against sin, which every Christian must do all through life, but he is consistently defeated by sin. He describes himself as “*sold into bondage to sin*” (**7:14**). He is “*not practicing*” what he would like to do, but is doing the very thing he hates (**7:15**). He wills to do good, but he does *not do it* (**7:18**). He *practices* the very evil that he does not want to do (**7:19**). He describes himself as a *prisoner* of the law of sin (**7:23**). These descriptions are contrary to **1 John 3:9**, which says that believers cannot continue to sin as a normal way of life. Believers do sin, but they do not live in perpetual defeat to sin as Paul here describes. Mature believers do not continue practicing sin or living in slavery to it.

I’m sensitive to the argument that in light of **chapter 6**, no believer could say that he is “*sold into bondage to sin*” and “*a prisoner of the law of sin.*” As I said, that is the strongest argument that this is an unbeliever. But an unbeliever would not experience this intense hatred of his sin and

inner desire to be free from it. And a mature believer would not describe himself as being in bondage to sin. Thus I think that Paul is **describing his experience as a new believer**, before he understood that he had died to the law and been joined in marriage to Christ and before he learned to walk by means of the Holy Spirit.

Since Paul before his conversion was a legalistic Pharisee, it's not likely that immediately after his conversion he understood that he was dead to the law or that he now could live by the power of the Holy Spirit. He probably began his Christian experience by striving to obey the law in the flesh. After a time of trying and failing and trying again and failing again, he finally broke through to realize, "*Sin shall not be master over you, for you are not under law, but under grace*" (6:14). He came to understand that since he was identified with Christ in His death, he was now free from the law, so that now he could serve in newness of the Spirit (7:4, 6). He grew to understand his new identity in Christ. He realized the glorious truth, "*Therefore there is now no condemnation for those who are in Christ Jesus*" (8:1). But it probably took him a while, perhaps a few years, to work through all of this both theologically and practically in terms of his daily experience. My understanding is that he is sharing those **early struggles** in **Romans 7:14-25**.

Leedy Greek NT Diagrams:

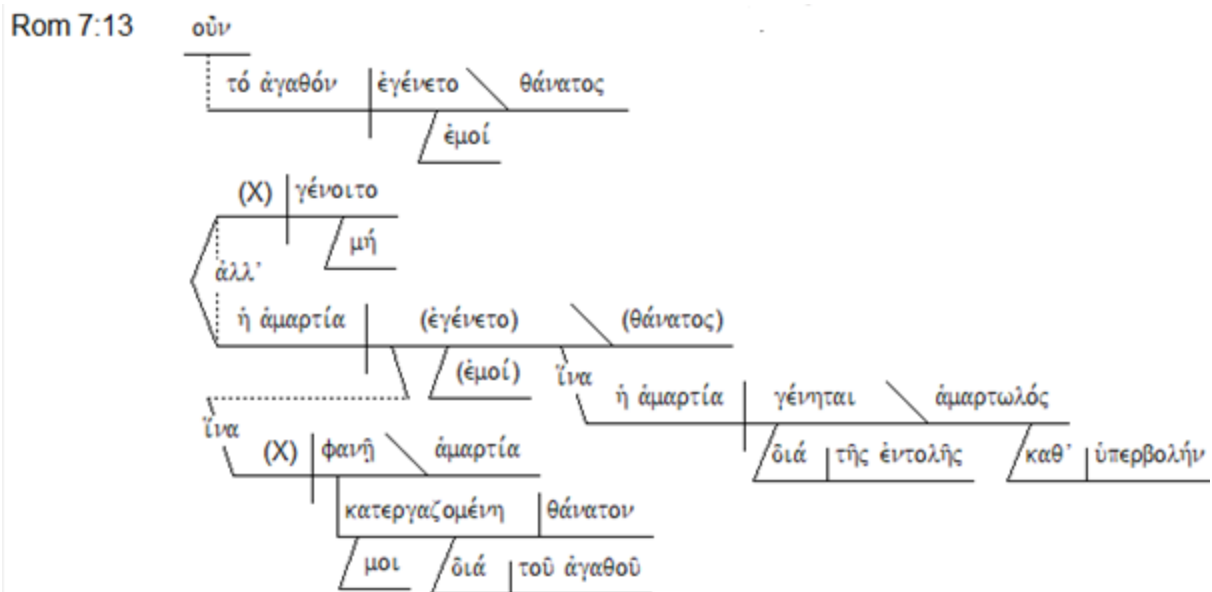

Rom 7:14

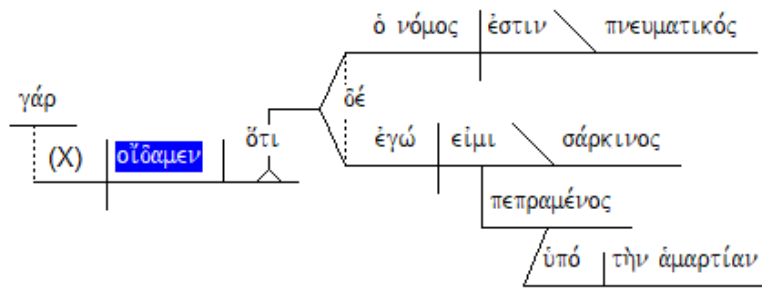

Rom 7:15

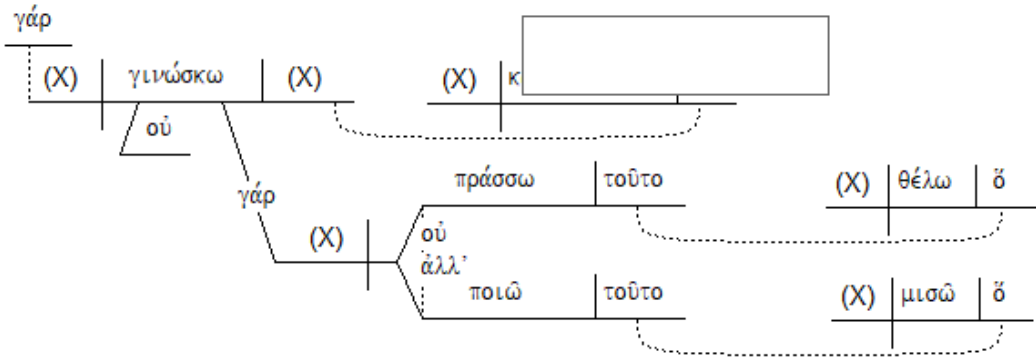

Rom 7:16

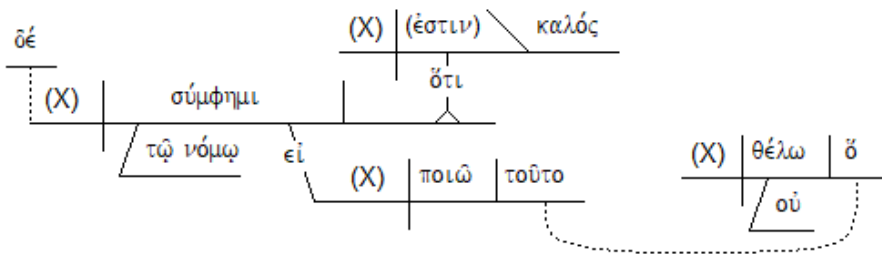

Rom 7:17

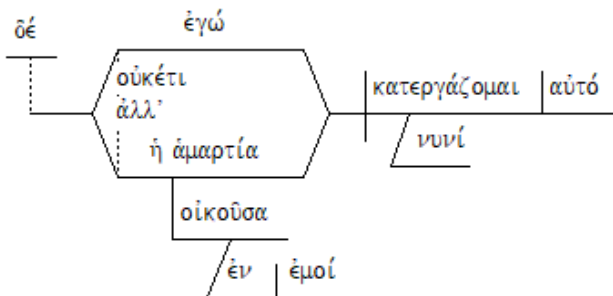

Rom 7:18-19

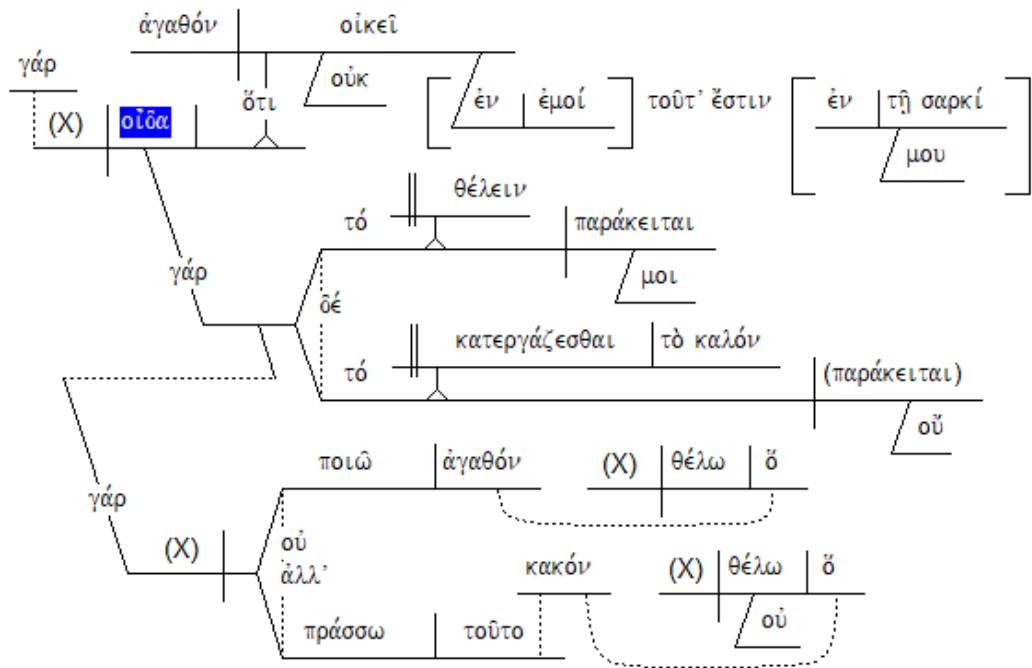

Rom 7:20

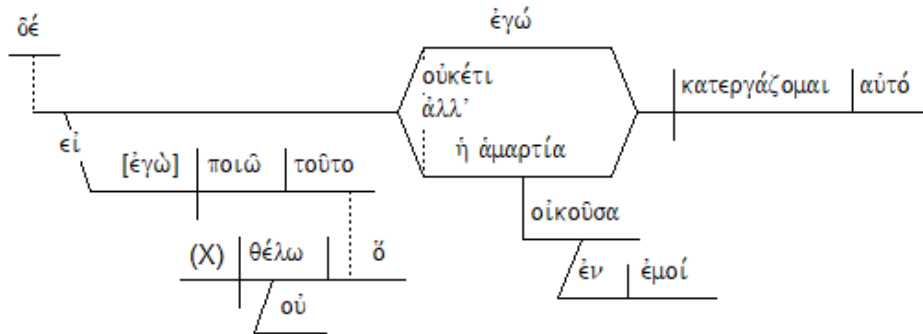

Rom 7:21-23

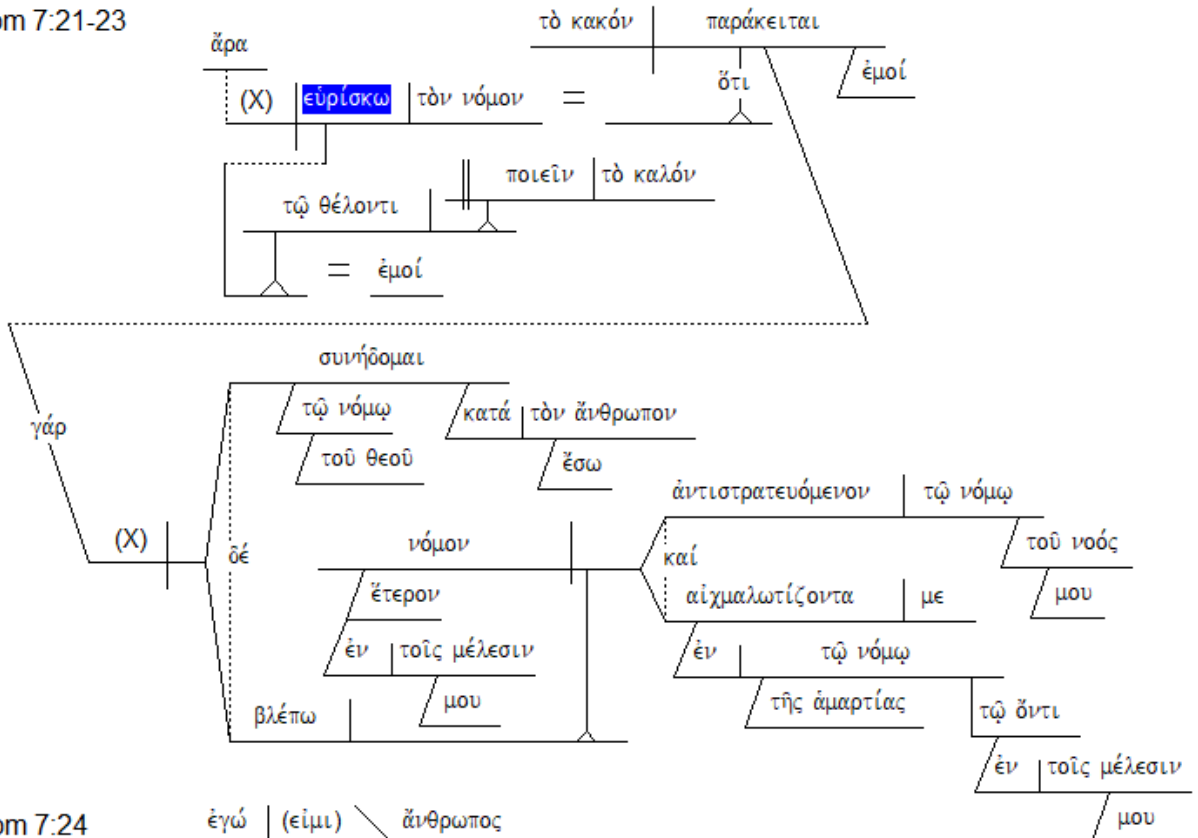

Rom 7:24

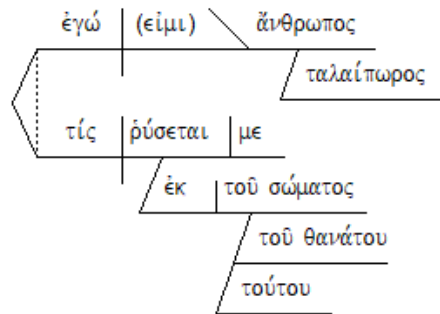

Rom 7:25

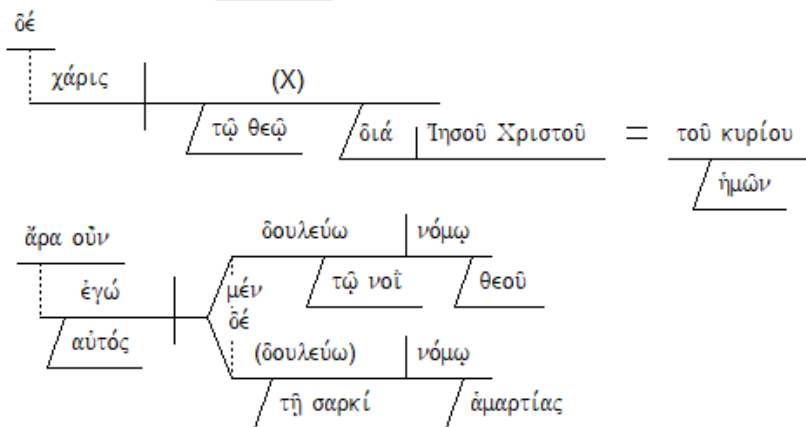

Frank Thielman:

- 14a Basis For **we know that the law is spiritual,**
b Contrast/Comparison but **I am fleshy,**
c Restatement **sold under sin.**
- 15a Explanation (of 14b–c) For **I do not understand what I produce,**
b Explanation (of 15a) for **it is not what I want that I accomplish,**
c but **precisely what I hate that I do.**
- 16a Condition But if I do precisely what I do not want,
b Assertion **I concur**
c with the law
d Content that it is good.
- 17a Inference And **now I no longer produce it,**
b but **sin that dwells within me.**
- 18a Restatement (of 17a–b) For **I know that good does not dwell in me,**
b Explanation (of 18a) for **willing lies close at hand,**
c Alternative but **producing what is praiseworthy does not.**
- 19a Restatement (of 18a–b) For **I do not do the good that I will,**
b but **I accomplish precisely the evil that I do not will.**
- 20a Condition But if I do precisely what I do not want,
b Inference (cf. 17a) **I no longer produce it**
c (cf. 17b) but **sin that dwells in me.**
- 21a Summary So **I discover the law**
b Content that when I want to do what is excellent, evil lies close at my hand.
- 22a Explanation (of 21b) For **I rejoice in the law of God**
b Place in the inner human being.
- 23a Contrast/Comparison But **I see another law in my members**
b Result warring against the law of my mind and
c Result taking me captive by the law
Description of sin
d Place that exists in my members.
- 24a Exclamation **I am a miserable human being!**
b Question **Who will deliver me from the body of this death?**
- 25a Answer But **thanks be to God through Jesus Christ our Lord!**
b Summary So then, **I myself serve the law of God**
with my mind but
with my flesh the law of sin.

TEXT: ROMANS 8:1-4

TITLE: NO CONDEMNATION BUT FREEDOM FROM SIN AND DEATH

BIG IDEA:

IN CHRIST THERE IS NO CONDEMNATION BUT FREEDOM TO LIVE A NEW LIFE OF RIGHTEOUSNESS BY THE POWER OF HIS SPIRIT

INTRODUCTION:

Frank Thielman: The solution to the plight of the wretched human Paul depicted in 7:7–25 comes with the work of Christ and the indwelling Spirit. Christ’s incarnation and death punished sin and thereby ended the desperate plight of sin, sin’s use of the law, and death described in 7:7–25. Christ’s incarnation and death also marked the new age of the Spirit. The Spirit now dwells within believers, enabling them to please God in the present and, in the future, to live with Christ in the presence of God.

Thomas Schreiner: As Paul’s own history demonstrates, the law doesn’t break the power of sin but paradoxically exacerbates it. God’s saving promises to his people have not become a reality via the law. God’s promises are now being fulfilled through Jesus Christ. He is the one who liberates his people and accomplishes what was promised in the OT Scriptures. The gift of the Spirit demonstrates that the covenant promises are now being realized, since the Spirit is the gift of the new age. In **chapter 8** Paul relays the means by which the power of sin is broken. The solution lies in the work of Jesus Christ on the cross and the gift of the Holy Spirit. Christ’s work on the cross provides the basis for delivering believers from condemnation, while the Holy Spirit supplies the power for conquering sin so that the law can now be kept (**8:1–4**), though such obedience is flawed and imperfect in this present evil age.

Michael Bird: The discourse of **Romans 8**, as **Fitzmyer** observes, is “a certain peak in Paul’s whole discussion” because it seeks to bring out the reality of the new age and of the new life that believers can now share in union with Christ and through his Spirit. **Romans 8:1-17** in particular involves rehashing some earlier themes from **5:1-11** and **6:1-23** about our righteous standing before God, the beginnings of moral transformation, and our spiritual vivification. For the most part, however, Paul’s argument here is breaking new ground in Romans as it centers on how to live a life pleasing to God, a life that is lived in accordance with the Spirit rather than in accordance with the flesh.

**I. (:1-2) TRUE LIBERATION –
IN CHRIST, WE ARE NO LONGER CONDEMNED BUT FREED BY CHRIST’S
LIFE-GIVING SPIRIT**

A. (:1) No Condemnation

“There is therefore now no condemnation for those who are in Christ Jesus.”

John Murray: “*Condemnation*” is the opposite of justification (cf. **5:16; 8:34**) and justification implies the absence of condemnation. . . The word “*condemnation*” here can scarcely be interpreted apart from the immediately succeeding **context** in which it appears and so we must look for the specific complexion given to the word by this context to which it is so closely related. In this context, as will be shown later, the apostle is not dealing with justification and the expiatory aspect of Christ’s work but with **sanctification** and with what God has done in Christ to **deliver us from the power of sin**. Hence what is thrust into the foreground in the terms “*no condemnation*” is not only freedom from the guilt but also freedom from the enslaving power of sin. If this appears to be a strange notion in connection with “*condemnation*” we shall have to wait for a vindication of this concept in the exposition of the verses which follow. If, however, this view of “*condemnation*” is adopted, then this verse, as inference, can be connected with what immediately precedes, either restrictedly (**7:25**) or more inclusively (**6:1 – 7:25**). The latter alternative is preferable, as will appear later on.

Frank Thielman: “*In Christ Jesus*” (ἐν Χριστῷ Ἰησοῦ) describes the realm in which believers live, the realm in which people experience “justification” and “redemption” (**3:24**), where they are dead to sin and alive to God (**6:11**), and where they receive God’s free gift of life rather than sin’s wages of death (**6:23**). These eschatological blessings have broken into the present, as the term “*now*” (νῦν) demonstrates (cf. **7:6**).

B. (:2) Freedom from Bondage

*“For the law of the Spirit of life in Christ Jesus
has set you free from the law of sin and of death.”*

Frank Thielman: Paul now supplies the reason why (γάρ) God releases those who are in Christ Jesus from punishment. The phrase “*in Christ Jesus*” (ἐν Χριστῷ Ἰησοῦ) could modify “*life*” (ζωῆς) and refer to the life that people have who are united with Christ (Tyndale, Luther, KJV, RSV, NRSV, NAB, CEB). If Paul had intended “*in Christ Jesus*” to modify “*life*,” however, he would probably have made this clear with an article in front of the phrase (τῆς ζωῆς τῆς ἐν Χριστῷ Ἰησοῦ) as he does when he speaks in **3:24** of “the deliverance that is in Christ Jesus” (τῆς ἀπολυτρώσεως τῆς ἐν Χριστῷ Ἰησοῦ). The phrase, then, probably **modifies the verb** and speaks of the means by which “*the law of the Spirit of life*” has freed individuals from “*the law of sin and death*” (NIV, REB, ESV). God freed them from sin and death **by means of Christ Jesus**, or as **8:3** will explain more specifically, through his incarnation and death. . .

“*The law of the Spirit of life*,” then, is the power of God’s Spirit that enables believers to break free from sin’s use of the law for its own deadly purposes (cf. **7:5, 8–11**) and experience eternal life (**6:22**).

This “*law of the Spirit of life*” liberates the believer from “*the law of sin and death*.” The meaning of “*the law of sin and death*” is clear from Paul’s discussion of the law in **7:1–25**. There, sin used the law to multiply itself and keep the “fleshy” human being in bondage to itself and on the path to death. Now Paul announces the good news of God’s remedy to this terrible plight. God’s Spirit, by means of Christ Jesus, has broken the stranglehold that sin had on the law and, through the law, on the sin-prone self. The language of liberation recalls Paul’s use of slave imagery in the previous argument for the plight of human beings under the power of sin (**6:16**,

18, 20, 22; 7:14, 23). The Spirit has now freed them from this bondage and given them life (cf. 6:22–23).

John Murray: It is eminently appropriate that the Holy Spirit should be designated as the Spirit of life because the power he exercises is unto life as distinguished from the power of sin which is unto death. “*The law of the Spirit of life*” is, therefore, the power of the Holy Spirit operative in us to make us free from the power of sin which is unto death. This deliverance from the power of sin is correlative with that enunciated by the apostle in 6:2–14. The Holy Spirit is the Spirit of Christ (cf. vs. 9) and it is only in Christ Jesus that the Spirit’s power is operative unto life.

II. (:3) TOTAL DELIVERANCE – GOD SENT HIS OWN SON TO DO WHAT THE LAW COULD NOT

A. Inability of the Law

For what the Law could not do, weak as it was through the flesh,”

B. Intervention of God’s Son

“God did: sending His own Son in the likeness of sinful flesh and as an offering for sin,”

John Murray: There does not appear to be good warrant for supposing, as has been done by many interpreters, that the reference is to the expiatory action of God in the sacrifice of Christ. While it is true that the work of Christ in reference to sin was expiatory and in that respect involved for him the vicarious endurance of the condemnation due to sin, yet that expiatory accomplishment is not defined in terms of the **condemnation of sin**. Furthermore, as we found already, the governing thought of this passage is concerned with **deliverance from the law of sin and death and, therefore, from sin as a ruling and regulating power**. Hence we are compelled to look in some other direction to see if there is any respect in which we might conceive of God as condemning sin in a way that is relevant to the governing thought of the passage. . . . Since then judicial language is applied to the destruction of the power of the world and of the prince of darkness and since the term “*condemnation*” is used here respecting the work of Christ, there is warrant for the conclusion that the condemning of sin in the flesh refers to the judicial judgment which was **executed upon the power of sin** in the cross of Christ. God executed this judgment and overthrew the power of sin; he not only declared sin to be what it was but pronounced and executed judgment upon it. Furthermore, it is this constitutive meaning of condemnation that provides the proper contrast to what the law could not do. In the barely declarative sense the law could condemn sin; this is one of its chief functions. But **the law cannot execute judgment upon sin so as to destroy its power**. As the apostle had shown repeatedly in the preceding chapter, the law, rather than depriving sin of its power, only provides the occasion for the more violent exercise of its power. To execute judgment upon sin to the destruction of its power the law is impotent. This is exactly what God did by sending his own Son in the likeness of sinful flesh and for sin. Hence when both the negative and the positive elements of the text are analyzed they mutually support each other in pointing to the interpretation presented.

Michael Bird: the “*sending*” of the Son is implicit to Jesus’ preexistence and incarnation. Jesus comes from the Father to earth by taking on “*flesh*,” which naturally suggests that the Son moves from one state (i.e., preexistence) to another state that he did not previously possess (i.e.,

“*flesh*”). In any case, the purpose of that sending is chiefly redemptive as the Son comes to redeem and restore the covenant people and to include the Gentiles in the patriarchal promises (see **Rom 8:32; 15:8; Gal 3:14; 4:4-5**). . .

“*in the likeness of sinful flesh*” -- The issue here is that Paul does not want to say that God sent Jesus in sinful flesh, since that would imply that the enfleshing of the Son took on the sinful condition, which itself needs deliverance. What Paul wants to say is that Jesus’ humanity was the same as ours and yet not totally like ours to the point that he was tainted with sin. Jesus was just like us in possessing human flesh, and yet totally unlike us by not participating in a sinful nature. It may be more appropriate, therefore, to translate the phrase along the lines of God sending Jesus in the “same body as humans, who are controlled by sin” (CEB; cf. NJB).

C. Indictment on Sin

“He condemned sin in the flesh,”

III. (:4) TRANSFORMED LIVES – GOD’S INTENT IS TO HAVE US LIVE RIGHTEOUS LIVES THROUGH THE POWER OF HIS SPIRIT

A. Purpose of Christ’s Sacrifice

“in order that the requirement of the Law might be fulfilled in us,”

Frank Thielman: Paul does not imply, however, that this happens perfectly in the present. His purpose clause describes an ethical trajectory that ends at the resurrection when those whom God has united with Christ’s death in the present will also be fully united with his resurrection. Now that God has broken the power of sin, as Paul described it in **7:7–25**, believers begin to fulfill the law in the present. That fulfillment will not happen, however, until God gives life to the mortal bodies that continue to affect the present existence of believers (**8:10–11**).

Douglas Moo: The purpose of this work of God in Christ is spelled out in **verse 4**. The NIV translation is misleading. Paul does not claim that the “righteous requirements of the law” are fulfilled in us; he says that “*the righteous requirement of the law was fulfilled in us*” (the Greek word *dikaioma* is **singular**). The difference may not be great if Paul is thinking of the way that the Spirit enables Christians to obey the commandments of the law. But the singular word, along with the passive form of “*fulfill*,” suggests a different idea: **God in Christ has fulfilled the entirety of the law’s demand on our behalf.**

Michael Gorman: The purpose of the Messiah’s death, then, was not merely forgiveness but also **empowerment** and **transformation** (cf., again, **2 Cor 5:21**), which is what the prophets Ezekiel and Jeremiah had promised for God’s people. There has been restoration to life, a resurrection or revivification from the dead (cf. **Eph 2:1–10**), as prefigured by Abraham (**ch. 4**). The righteousness/justice that humanity failed to embody (e.g., **1:18–32; 3:9–20**) can now be enacted—is now being enacted.

B. Potential for Transformed Living

1. Not Walking in the Flesh

“who do not walk according to the flesh,”

2. But Walking in the Spirit

“but according to the Spirit.”

John Toews: The old power structure of the flesh/Sin has been displaced by the new power structure of the Spirit, which is the Spirit of Christ (**vv. 2, 9**). Followers of Jesus walking in the power field of the Spirit fulfill the law. The fulfillment of the just requirement of the law is not the goal of Christian doing, but its basis and context. The law is not fulfilled because it has been internalized (**Jer. 31** is not the background), but because the Spirit has been internalized. The Spirit now lives where Sin once lived. Therefore, the law is fulfilled.

* * * * *

DEVOTIONAL QUESTIONS:

- 1) Do you have **assurance** that you are in Christ and therefore under no condemnation?
- 2) What evidence do you see in this passage supporting the operation of the **Trinity** in our sanctification?
- 3) Why does Paul refer to the Spirit’s operation as “*the law*” of the Spirit of life in Christ Jesus?
- 4) What are some practical evidences of *walking in the Spirit*?

* * * * *

QUOTES FOR REFLECTION:

Douglas Moo: **Romans 8** has been called the “inner sanctuary within the cathedral of Christian faith.” It sets before us some of the most wonderful blessings we enjoy as believers: being free from God’s condemnation, indwelt by God’s own Spirit, adopted into his family, destined for resurrection and glory, and full of hope because of God’s love for us and because of his promise to bring good to us in every circumstance of life.

How does this rehearsal of the glorious benefits of being “*in Christ*” fit into Paul’s argument in these chapters? The first part of the chapter (**8:1–13**) has two purposes.

- (1) It elaborates the reference to the “*new way of the Spirit*” in **7:6** after the “interruption” in which Paul deals with questions about the law (**7:7–25**). Reference to the Holy Spirit is long overdue in Paul’s discussion of the believer’s existence. Possessing the Spirit is the mark of being a new covenant believer, and his ministry must be basic to any description of what it means to be a Christian. While the Holy Spirit is not really the topic of **Romans 8**, Paul gives the

Spirit the key role in mediating to us the blessings of our new life. Twenty-one times Paul uses the word *pneuma* (S/spirit) in **Romans 8**, and all but two (vv. **15a**, **16b**) refer to the Holy Spirit.

(2) **Verses 1–13** have another, more fundamental purpose. **Chapters 6** and **7** are slight detours from the main line of Paul’s argument, in which he deals with sin and the law, two key threats to the security of our new life. Now he is in a position to return to the main road by continuing his exposition of the believer’s security in Christ. So in this section he reaffirms our new life in Christ (vv. **1–4**) and draws out its consequences for the moral life (vv. **5–8**), the future, “resurrection” life (vv. **9–11**), and the responsibility of the believer (vv. **12–13**).

Grant Osborne: We feel condemned because Satan uses past guilt and present failures to make us question what Christ has done for us. Our assurance must be focused on Christ, not our performance.

- Our own conscience reminds us of guilt.
- Non-Christian friends will notice (and point out) our inconsistencies.
- Past memories of how we lived can haunt us.
- Personal dysfunctions such as shame, low self-esteem, or compulsions will trip us up.
- The perfection of the law will show how imperfect we are.
- We can allow Christ’s perfect example to discourage our efforts rather than encourage our trust.
- Unhealthy comparisons with other believers will make us feel inadequate.

Ron Barnes: Rom. 8 – Three Assurances from Paul to Believers

Horatius Bonar writes,

“Uncertainty as to our relationship with God is one of the most enfeebling and dispiriting of things. It makes a man heartless. It takes the pith out of him. He cannot fight; he cannot run. He is easily dismayed and gives way. He can do nothing for God. But when we know that we are of God, we are vigorous, brave, invincible. There is no more quickening truth than this of assurance.”

Therefore, I believe the primary focus in **Romans 8** is the blessed assurance in the life of the child of God. Assurance must color and fill our lives. What causes us to have assurance in this life as believers?

Romans 8 assures believers of three blessed things:

- their salvation,
- God’s sovereignty, and
- Christ’s immeasurable love.

Steven Cole: Set Free

Personally, I’ve come to **Romans 8** again and again when I’ve been discouraged or depressed. I don’t see how you can read **Romans 8** and remain down. If you struggle with guilt, read **Romans 8**. If you struggle with sin, read **Romans 8**. If you’re going through trials, read **Romans 8**. If you don’t know how to pray, read **Romans 8**. If you’re struggling with assurance of your salvation, read **Romans 8**. Interestingly, while the flavor of **Romans 8** is exhortation, there is not a single command in the chapter. The German Pietist **Philipp Spener**

said that if the Bible were a ring and Romans its precious stone, **chapter 8** would be “the sparkling point of the jewel” (F. Godet, *Commentary on Romans* [Kregel], p. 295). . .

God has graciously set free from sin’s penalty and power all who are in Christ Jesus.

“As a believer should I feel guilty when I sin?” If there is **no condemnation**, should we refuse to feel guilty when we disobey God? I would argue that properly understood, believers *should* feel guilty when they sin. The guilt stems from the fact that I have violated God’s holy Word. I have disobeyed my loving heavenly Father. Rather than loving my Savior, who went to the cross on my behalf, I have loved the sin that put Him there. Feelings of guilt that lead to genuine sorrow and repentance when I disobey God are appropriate.

On the other hand, I should not feel the guilt of condemnation that stems from the accuser’s false charge: “True Christians don’t do what you did. You’re not even a Christian!” If I mourn over my sin and am repentant before God over it, then I must accept His forgiveness and answer the accuser with the blood of the Lamb and the word of my testimony that I trust in Jesus (**Rev. 12:10-11; Zech. 3:1-5**). To put it another way, **the guilt that I feel when I sin is relational, as a child to my Father. It is not forensic, as a criminal before the judge. . .**

But, thankfully, God intervened! He sent His own Son. **Salvation is completely from the Lord.** God’s sending His Son implies the **pre-existence** of the Son. Did you notice the **Trinity** in our text? God the Father sent Jesus Christ His Son to offer Himself for our sins, so that the Holy Spirit could provide us with new life. God is one God who exists eternally in three distinct persons, each of whom is fully God. The word *own* is emphatic and shows us God’s great love for us: He sent none other than *His own Son* (**5:8**).

S. Lewis Johnson: Power of the Indwelling Spirit

I would suggest to you that the apostle’s thought goes back to **verse 6** of **chapter 7**. The intervening verses answer some questions. They are excurses on two questions. **Verse 7**, “*Is the law sin?*” No, Paul says, the law is not sin. The law is holy, just, and good. “*Well then,*” **verse 13**, “*well then was that which is good made death unto me?*” Paul said no, the law was not made death unto me. The reason that there is death in my life is indwelling sin. And with that he resumes his positive argument which concluded with **verse 6** and the words that we should “*serve in newness of spirit and not in the oldness of the letter,*” having been released from the law.

Now then we would follow naturally here with, “*There is now therefore no condemnation to them who are in Christ Jesus. For the law of the Spirit of life in Christ Jesus hath made me free from the law of sin and death.*” So now he comes back to the idea of **liberation from the Law of Moses** now relating it to the ministry of the Holy Spirit. It’s in my mind that’s what the apostle is really speaking about here.

Now what he is then essentially saying is that we have **freedom from sin**, and we have **freedom from death**, and it is found in a **new law**, the law of the spirit of life in Christ Jesus. The Mosaic law pointed out our sin, and in pointing out our sin pointed out, of course, the fact that we were liable to death. So the law came that men might see that they were sinners, and thus see that they

truly were **dead before God; condemned**. Now there is a new law, the law of the spirit of life in Christ Jesus. It has made me free from the law of sin and death.

Leedy Green NT Diagrams:

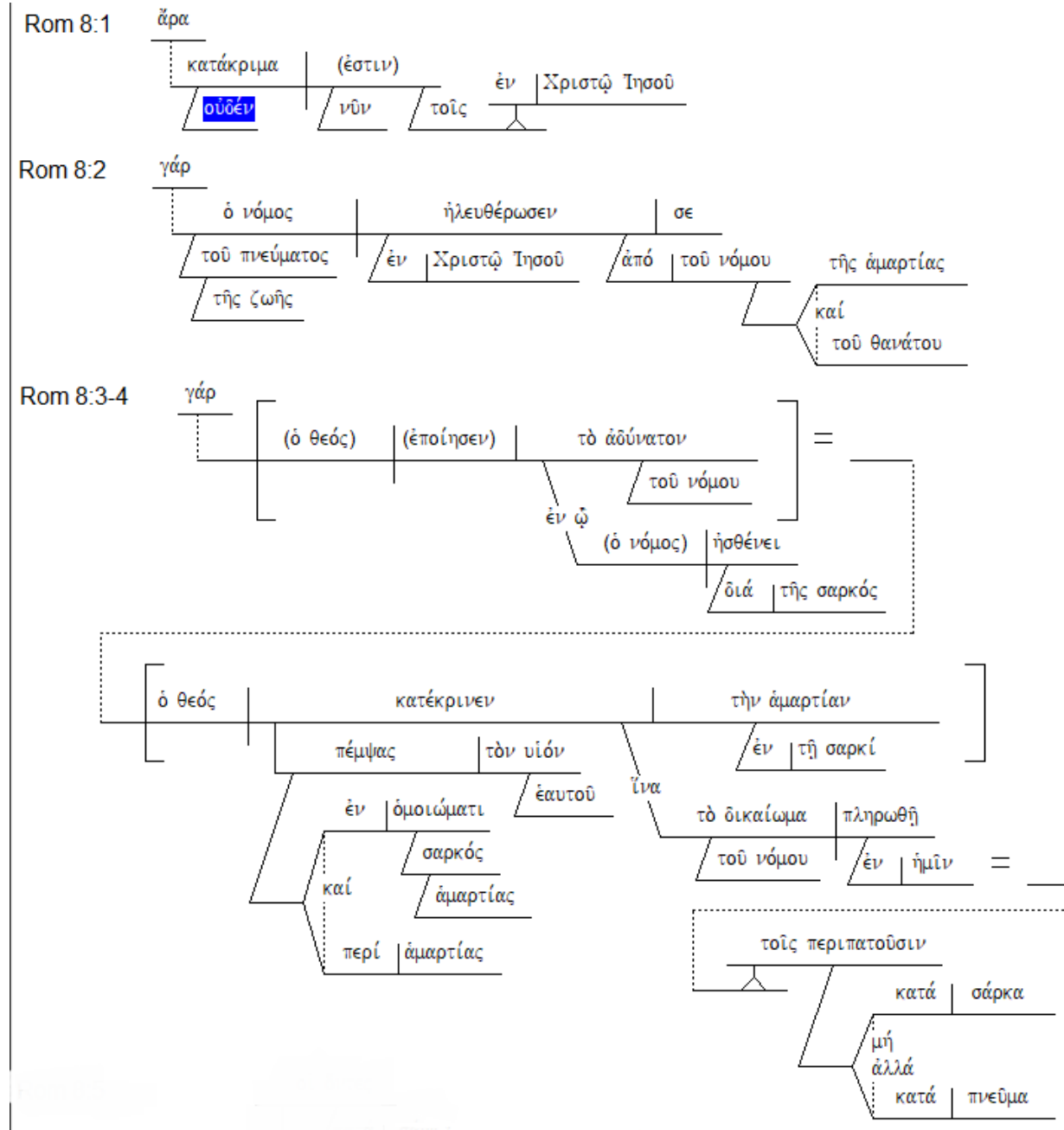

Frank Thielman:

- 1a Inference (from 7:6) **No condemnation now comes,** therefore,
b to those who are in Christ Jesus.
- 2a Explanation (of 1a) For **the law of the Spirit of life has liberated you**
b Means (of 2a) through Christ Jesus
c Separation from the law of sin and death.
- 3a Explanation (of 2a–c) For **[this is] the very thing the law found impossible**
b Cause (of 3a) because it was weakened by the flesh:
c Identification (of 3a) **God condemned sin in the flesh**
d Means (of 3c) by sending his own Son
e Manner in the likeness of sinful flesh and
f Purpose (of 3d) for sin
- 4a Purpose (of 3c) so that the righteous requirement of the law might be fulfilled in us
- b Description who walk not according to the flesh but according to the Spirit.
- 

TEXT: ROMANS 8:5-13

TITLE: CONTRAST BETWEEN WALKING IN THE SPIRIT VS THE FLESH

BIG IDEA:

THE INCLINATION OF OUR HEART IS REVEALED BY WHETHER WE WALK IN THE SPIRIT OR IN THE FLESH

INTRODUCTION:

Michael Bird: Paul's purpose in vv. 5-8 is not to warn Christians about the perils of walking, living, and thinking in the realm of the flesh. He will do that soon enough in v. 13, but here he presents more of a contrast between those who belong to the flesh and those who belong to the Spirit. In other words, Paul is not making an exhortation to believers at this point but is juxtaposing two groups of people, the converted and the unconverted. It is a kind of argument to the effect "think of what you were when you were called" to underscore their sinful state prior to coming to Christ, set in direct contrast to the spiritual life that they now possess (see **1 Cor 1:26; 6.11; Eph 2:1 – 3**). According to **Moo**: "Paul's main purpose is to highlight the radical differences between the flesh and the Spirit as a means of showing why only those who 'walk/think/are' after the Spirit can have eschatological life."

David Thompson: IT IS NOT OUR FLESH THAT GUARANTEES WE WILL BE PLEASING TO GOD; IT IS THE HOLY SPIRIT WHO LIVES IN US THAT GUARANTEES WE WILL BE PLEASING TO GOD. . .

In view of how God has favored us by graciously giving us His Spirit, we have a **continual obligation** not to be continually living according to the flesh. This does not mean there will not be moments of failure, but we have the responsibility to see that those moments of failure do not become our habitual or continual pattern of life. We have an obligation to see to it that our flesh does not continually control the way we live. The antithesis of this is that we have an obligation to see to it that the Holy Spirit is who continually controls our pattern of life.

A. Berkeley Mickelson: Here the stress is on those who are in accordance with the flesh or with the Spirit. In one group are those occupied with all the particulars that go into a sinful life. In the other group are those occupied with all that goes into life under the direction and power of the Spirit.

S. Lewis Johnson: In the **fifth verse** of the chapter the apostle gives the first of the reasons why believers walk after the Spirit. In other words, the "*for*" of the verse is connected with the last clause of the preceding verse. **Men walk according to the inward inclination, bent, or disposition that they have.** Thus, those who have at their inmost center the lusts of the flesh will walk after the flesh, while the opposite is true of those who walk according to the Spirit. To "*be*" after the flesh is to exist only for the flesh, and the clause, then, refers to the unbeliever. They mind the things of the flesh, that is, they think and will according to the desires of the flesh. Their conduct follows accordingly. On the other hand, they that "*are*" after the Spirit think and

will according to inclinations implanted by Him in the inmost being of the believer. They are inclined to holiness, just as the unbelievers are inclined to unholiness. The renewed nature of the believer, upheld by the Spirit, determines the bent of the life.

I. (:5-8) OUR WALK REFLECTS OUR MINDSET

Warren Wiersbe: Paul is not describing two kinds of Christians, one carnal and one spiritual. He is contrasting the saved and the unsaved. There are four contrasts.

- *In the flesh – in the Spirit* (v. 5)
- *Death – life* (vs. 6)
- *War with God – peace with God* (vv. 6-7)
- *Pleasing self – pleasing God* (v. 8).

A. (:5) What Is Our Mindset?

1. Things of the Flesh

“For those who are according to the flesh set their minds on the things of the flesh,”

John Murray: “*The flesh*” is human nature as corrupted, directed, and controlled by sin. “*After the Spirit*” (vss. 4, 5) and “*in the Spirit*” (vs. 9) are also to the same effect, with a similar distinction as to the angle from which the relationship to the Holy Spirit is viewed. Those concerned are conditioned by and patterned after the Holy Spirit.

To “*mind the things of the flesh*” (vs. 5) is to have the things of the flesh as the absorbing objects of thought, interest, affection, and purpose. And “*the mind of the flesh*” (vs. 6) is the dispositional complex, including not simply the activities of reason but also those of feeling and will, patterned after and controlled by the flesh. In like manner to mind “*the things of the Spirit*” (vs. 5) is to have the things of the Holy Spirit as the absorbing objects of thought, interest, affection, and purpose, and “*the mind of the Spirit*” is the dispositional complex, including the exercises of reason, feeling, and will, patterned after and controlled by the Holy Spirit.

2. Things of the Spirit

“but those who are according to the Spirit, the things of the Spirit.”

Frank Thielman: Paul probably intended, therefore, to communicate that the pattern of life dictated by the flesh and the pattern of life dictated by the Spirit are rivals grappling for influence over the person. In the language of Paul’s letter to the Galatians, “*the desires of the flesh are against the Spirit, and the desires of the Spirit are against the flesh, for these are opposed to each other, to keep you from doing the things you want to do*” (Gal 5:17; cf. Rom 7:16, 19–20, 23). The cognitive element preserved in most translations and assumed by most commentators is not missing, however, as his use of the noun “*mindset*” (φρόνημα) in 8:6–7 shows (cf. 8:27).

The Spirit lives within believers (8:9), so the believer’s life is governed by the Spirit’s norms. These norms are expressed in “*the righteous requirement of the law,*” which, as we saw in the

comments on **8:3–4**, is probably a reference to the **love command** as the summary of the law. The Spirit, then, frees believers from the domination of sin and the flesh and empowers believers to live in a new way, oriented toward love for others.

Michael Gorman: Life in the Spirit is not, however, automatic; it requires **active participation** by believers, who must now set their minds on (the things of) the Spirit (as Paul said in **8:5–6**) and actively oppose the flesh (**8:12–13**; cf. **6:12–13**; **Gal 5:16–26**).

B. (:6) What Is Our Disposition?

1. Death

“For the mind set on the flesh is death,”

2. Life and Peace

“but the mind set on the Spirit is life and peace,”

Frank Thielman: Here Paul uses the term metaphorically to describe the natural, and opposing, dispositions of the flesh and the Spirit. The flesh tilts those whose existence belongs to it toward death, and the Spirit tilts those who belong to him toward life and peace. This mention of “*peace*” as something the Spirit brings recalls Paul’s description in **5:1–11** of the peace that believers have with God after the outpouring of his love through the Holy Spirit and after the initiative he took in the death of Christ to reconcile himself to his enemies (**5:1, 6–10**).

C. (:7-8) What Characterizes the Mind Set on the Flesh?

1. (:7a) Hostility toward God

“because the mind set on the flesh is hostile toward God;”

2. (:7b) Rebellion against God

“for it does not subject itself to the law of God,”

3. (:7c) Inability to Obey God

“for it is not even able to do so;”

R. Kent Hughes: The mind-set of those without Christ has distinct characteristics:

- death,
- hostility toward God, and
- an inability to subject itself to God.

These govern its orientation to all of life.

Steven Cole: Paul does not stop by saying that those who are in the flesh *do not* submit to God’s law. He goes further by saying that they are *not even able* to do so, adding (**8:8**), “*and those who are in the flesh cannot please God.*” *Cannot* is a word of **inability**. It goes back to the matter of a sinner’s fallen nature in Adam, which is incapable of obeying God or pleasing Him. Just as a pig is free to act in line with its pig nature, but not in line with a human nature, so fallen sinners are free to act in line with the flesh, but not in line with the Holy Spirit, whom they do not possess.

But many who contend for so-called “free will” argue that God has given all people the ability to choose salvation. This is called “**prevenient grace**.” I don’t have time to go into the arguments for this doctrine, but they are biblically weak. (For a full refutation of this idea, see **Thomas Schreiner**, “Does Scripture Teach Prevenient Grace in the Wesleyan Sense?” in *Still Sovereign* [Baker], ed. by **Thomas Schreiner** and **Bruce Ware**, pp. 229-246.)

Suffice it to say that elsewhere Paul also teaches human inability to respond to the gospel apart from God’s gracious enabling power. That is clear from his reference to sinners as dead in their sins (**Eph. 2:1-5**) and as being blinded by Satan (**2 Cor. 4:4**). Dead people cannot choose to live. Blind people cannot choose to see. Paul also says that the natural man cannot understand the things of the Spirit of God, which includes the message of the cross, which he says is foolishness to the natural man (**1 Cor. 2:14**; cf. **1:18-30**).

Jesus also taught that no one *can* come to Him unless the Father grants it and draws him (**John 6:44, 65**). He pointedly asked the skeptical Jews (**John 8:43**), “*Why do you not understand what I am saying?*” He answered His own question, “*It is because you cannot hear My word.*” Obviously they could hear what He was saying, but they lacked the spiritual ability to hear with obedience.

And since those in the flesh cannot please God and faith pleases God (**Heb. 11:6**), sinners cannot believe in Jesus Christ for salvation by their own free will, apart from God’s special saving grace. The fallen human will is not free; it’s in bondage. This means that in the order of salvation, **regeneration precedes faith**. God must impart life to dead sinners so that they can believe the gospel (**John 1:13**; and, note the Greek verb tenses in **1 John 5:1**).

4. (:8) Inability to Please God

“and those who are in the flesh cannot please God.”

John Murray: In the whole passage we have the biblical basis for the doctrines of **total depravity** and **total inability**. It should be recognized, therefore, that resistance to these doctrines must come to terms not simply with the present-day proponents of these doctrines but with the apostle himself. “*Enmity against God*” is nothing other than **total depravity** and “*cannot please God*” nothing less than **total inability**.

William Hendriksen: It is interesting and instructive to note how often Scripture, especially Paul, describes the purpose of human life to be that of pleasing God (**Rom. 12: 1, 2; 14:18; 1 Cor. 7:32; 2 Cor. 5:9; Eph. 5:10; Phil. 4:18; Col. 3:20; 1 Thess. 4:1**). . . Paul, either explicitly or by implication, expresses his disapproval upon those who please not God but themselves. Cf. **Rom. 15:3; 1 Thess. 2:15**.

II. (:9-11) OUR WALK REFLECTS WHETHER THE HOLY SPIRIT LIVES IN US -- ALL CHRISTIANS HAVE THE INDWELLING SPIRIT TO GIVE VICTORY IN LIFE NOW AND RESURRECTION LIFE ULTIMATELY

A. (:9) Do We Possess the Indwelling Holy Spirit?

1. Holy Spirit Lives in Every Believer

*“However, you are not in the flesh but in the Spirit,
if indeed the Spirit of God dwells in you.”*

Douglas Moo: Every Christian really is “*in the Spirit*”—under his domination and control. We may not always reflect that domination (see **8:12–13**), but it is a fundamental fact of our Christian existence and the basis for a life of confidence and obedience to the Lord.

Steven Cole: If God’s Spirit dwells in you, you belong to Christ; and though your physical body will die, God will raise your body from the dead.

When we trusted Christ as Savior and Lord, we changed realms from living “*according to the flesh*” to living “*according to the Spirit*.” We used to be “*in the flesh*,” living under its ruling influence. Now we live “*in the Spirit*,” under His rule and the Spirit lives in us. . .

Some Pentecostal groups teach that you must receive the Holy Spirit **subsequent to salvation**. They base this on a misinterpretation of **Acts 19:2**, where Paul encounters some disciples of John the Baptist and asks, “*Did you receive the Holy Spirit when you believed?*” When they reply no, Paul explains some things, prays for them, and they receive the Holy Spirit. But it’s important to understand that Acts is a **transitional book** from the age of the Law, when the Spirit was only given to some and could be withdrawn (**Ps. 51:11**) to the age of the promised Holy Spirit, who permanently indwells all who are born again (**John 7:39; 14:17; 1 Cor. 12:13**). **Romans 8:9** makes it clear that if you have been born again, you have the Holy Spirit dwelling in you. If you don’t have the Spirit, you do not belong to Christ.

This does not mean that we should not ask for a deeper experience of the Spirit’s presence and power. We must yield more and more of ourselves to the Spirit’s control as we become aware of areas that we have not given to Him. We are commanded to walk by means of the Spirit (**Gal. 5:16**) and to be filled with (or controlled by) the Spirit (**Eph. 5:18**). But if you have been born again and your trust is in Christ as Savior and Lord, you do not need to receive the Holy Spirit. He dwells in every believer.

2. Holy Spirit Does Not Live In Any Unbeliever

*“But if anyone does not have the Spirit of Christ,
he does not belong to Him.”*

B. (:10) Dynamic Activity of the Indwelling Holy Spirit Promoting Righteous Living

1. Based on Union with Christ

“And if Christ is in you,”

Frank Thielman: The expression “*Christ is in you*” stands parallel to the ideas that God’s Spirit dwells within Paul’s audience and that they have the Spirit of Christ in **8:9**. This raises the question whether Paul distinguished between God’s Spirit, Christ’s Spirit, and the presence of Christ within believers. The answer becomes clear in **8:11** where Paul distinguishes between the Spirit of God on one hand and Jesus, whom God’s Spirit raised from the dead, on the other hand. Paul probably understood the Spirit of God as the means through which Christ was present with believers despite Christ’s physical location in his resurrected body at God’s right hand

(8:34). The situation is analogous to Paul's description of his own spirit's presence with the Corinthians for the purpose of church discipline in **1 Corinthians 5:3–5**.

2. Based on Freedom from the Power of Sin

“though the body is dead because of sin,”

3. Based on the Life-Giving Spirit

“yet the spirit is alive because of righteousness.”

John Murray: The ruling thought of the verse is that although believers die and this fact is conspicuously exhibited in the dissolution of the body, yet, since Christ dwells in believers, life-giving forces are brought to bear upon death and this life is placed in sharp contrast with the disintegrating power which is exemplified in the return to dust on the part of the body. Reference to the Holy Spirit as life is signally congruous with this thought.

C. (:11) Resurrection Hope

*“But if the Spirit of Him who raised Jesus from the dead dwells in you,
He who raised Christ Jesus from the dead
will also give life to your mortal bodies
through His Spirit who indwells you.”*

Frank Thielman: Just as Paul's audience possesses bodies that are subject to death, so Jesus was once among the dead; but just as God used the Spirit to raise Jesus from the dead, so this same Spirit, now dwelling within Paul's audience, will give life to their mortal bodies (cf. **2 Cor 5:4–5**).

The Roman believers, then, have a bright future in which they will one day inhabit bodies like Jesus's resurrected body (cf. **1 Cor 15:20–24, 48–56**). This is the “*eternal life*” that, according to **2:7**, God will give those who “*seek glory and honor and immortality by endurance in good work*” (**2:7**). It is the “*hope of the glory of God*” in which those who have been justified by faith can boast (**5:2**; cf. **5:5**). This is also the sense in which we shall be saved “*through*” Christ and “*by his life*” (**5:9–10**).

Michael Bird: Paul has shown earlier that the goal of grace is eternal life (**2:7; 5:21; 6:22–23**). The spiritual life enjoyed in the present is only a deposit of the life to come and not an end in itself (see **2 Cor 1:22–23; 4:16 – 5:5; Eph 1:13–14**). **Johnson**'s description is perfect: “The transforming Spirit that God has given to humans is the pledge and portent of future life in the resurrection.” There is a future life that is yet to arrive in the form of the resurrection of the coming age. If the Spirit who raised Jesus from the dead dwells in believers, this same Spirit who imparted glorious immortal life to Jesus will impart the same life to them. The nature of that resurrection life is explored elsewhere by Paul (see **1 Cor 15:35–58; Phil 3:21; 1 Thess 4:17**). What should be emphasized is that for Paul, this God-given “life,” both now and in the future, is the concrete incarnation of his righteous verdict. Righteousness reigns in life through resurrection life (see **5:17; 8:34**). Thus, God's righteousness is a verdict that vivifies.

John Murray: The leading thought of the whole verse may be set forth thus.

- (1) The Father raised up Christ.
- (2) The Holy Spirit is the Spirit of the Father when the Father is contemplated in this specific capacity as the one who raised up Jesus.
- (3) The Holy Spirit dwells in believers and dwells in them as the Spirit of the Father.
- (4) This indwelling of the Spirit, since it is an indwelling of the Spirit of him who raised up Jesus, guarantees the resurrection from the dead of those thus indwelt.

III. (:12-13) OUR OBLIGATION IS TO WALK IN THE SPIRIT – WALKING IN THE FLESH RESULTS IN DEATH BUT WALKING IN THE SPIRIT -- LIFE

A. (:12) Consistent Obligation

“So then, brethren, we are under obligation, not to the flesh, to live according to the flesh—“

Frank Thielman: The expression “*so then*” (ἄρα οὖν) introduces a **conclusion** drawn from the preceding discussion (cf. **5:18; 7:3, 25**), in this case the discussion in **8:1–11** of the believer’s liberation from the overpowering influence of the flesh (cf. **7:14–25**). If God has condemned sin in the flesh through the death of Christ (**8:3**) and believers do not walk according to the flesh (**8:4**), do not have the mindset of the flesh (**8:5–7**), and in some sense are not in the flesh (**8:9**), then **they owe the flesh nothing**.

The implied admonition here shows that Paul understood the danger that their fallen nature continued to present to believers. His point is not that his audience will no longer have a problem with sin but that the death of Christ and the presence of the Spirit have freed them from the overwhelming nature of sin’s power. They are now able to choose not to sin.

Michael Bird: The logic is that if Christ lives in them and if the Spirit enlivens them, it is unimaginable for anyone to live in the realm of the flesh.

Frank Murray: The force of the inference is apparent. How contradictory for us, having been delivered by the Spirit from the law of sin and death and being indwelt by the Holy Spirit, to yield our obedience and service to that from which the Holy Spirit has emancipated us!

Everett Harrison: “*Obligation*” is the keynote. Only the negative side is stated; the positive side – that we are debtors to the Spirit – must be inferred. If we do not have an obligation to live in terms of the sinful nature, the conclusion must be that our obligation is to live and serve God in terms of the Spirit. It is tremendously important to grasp the import of **v.12**, because it teaches beyond all question that the believer still has the sinful nature within himself, despite having been crucified with Christ. The flesh has not been eradicated. But we are obliged not “*to live according to it.*” There is really no option, for the flesh is linked to death as life is linked to the Spirit. Sanctification is not a luxury but a necessity. As **Bishop Handley Moule** stated, “It is not an ambition; it is a duty”.

B. (:13) Two Possible Destinies

1. Walking in the Flesh -- Death

“for if you are living according to the flesh, you must die;”

James Boice: Paul is saying that if you live like a non-Christian, dominated by your sinful nature rather than living according to the Holy Spirit, you will perish like a non-Christian—because you are a non-Christian.

2. Walking in the Spirit -- Life

“but if by the Spirit you are putting to death the deeds of the body, you will live.”

Steven Cole: You’ve probably seen the bumper sticker that says, “Kill your TV!” That may be wise advice, but the apostle Paul gives us even wiser counsel in our text: **Kill your sin!** It’s a concept that we don’t hear much about any more. But it used to be a widely understood approach to sanctification. The Puritans called it “**the mortification of sin.**” In our times, to be mortified means to be embarrassed, but the word really means to be killed. The Puritans all knew that we are engaged in mortal combat with an enemy that lurks within: the flesh (or the old man, or indwelling sin). Either you kill it every day or it will kill you. . .

“putting to death the deeds of the body” -- Paul is focusing on the body as the instrument through which the sinful deeds of the flesh are expressed. Until Jesus returns, we live in a body that is still prone toward sin. Sin is sin even on the thought level, before it ever displays itself through the body (**Mark 7:20-23**). But if we kill it on the **thought level**, it will not become a deed of the body. Sins that are expressed through the body are always worse than sins of the mind, because they damage others and bring dishonor to God. Thus we must put to death the deeds of the body by **cutting them off in the mind** before they are expressed openly.

Frank Thielman: The expression “*by the Spirit*” translates a dative of means (πνεύματι) and indicates the way in which believers are to put evil deeds to death. This does not imply that believers control or wield the Spirit as a tool since in the next sentence Paul describes them as “*led by the Spirit of God*” (**8:14**). Instead Paul must mean that the Spirit enables believers to do the good that the “*inner human being*” and the “*mind*” of the “*I*” of **7:22–23**, unaided by the Spirit, could not do (cf. **Gal 5:16, 25**).

* * * * *

DEVOTIONAL QUESTIONS:

- 1) How would you refute from this passage that a believer can choose either to be a sold-out disciple of Jesus or just a carnal Christian?
- 2) Does it take effort and discipline to follow the spiritually minded path in life or should this be automatic for believers?

3) What are the implications for our methods of evangelism from the understanding of man's inability to even believe the gospel apart from the work of the Holy Spirit?

4) How would you respond to a Pentecostal who claims that you need to be baptized in the Spirit in a climactic act subsequent to conversion?

* * * * *

QUOTES FOR REFLECTION:

Douglas Moo: Three points can be made briefly here.

(1) Paul is serious about the need for us to put into effect the new life God gives us. Our response is not optional; it is necessary.

(2) However, this response is itself empowered by the Spirit. We cannot stop committing sins in our own power; it can only be done "by the Spirit."

(3) Paul never suggests that the inheritance of future life requires that we stop sinning altogether. What he demands in this verse is clear, long-term, progress in becoming less like the world (i.e., "*the flesh*") and more like Christ. . .

The Spirit's presence in our lives inevitably produces fruit pleasing to God. Thus, we are secure. But the Spirit does not do his work apart from our response. I like the careful balance Paul achieves in **verse 13**: "*By the Spirit you put to death the misdeeds of the body*" (italics added). Paul puts the responsibility squarely on our shoulders: You need to put sin to death. But at the same time, he makes it clear that we can only do it through the Spirit.

Grant Osborne: When a person is determined to do something or to hold a certain belief or idea, we say that person has a certain mind-set. A mind-set:

- determines how a person acts
- motivates a person
- influences whom or what a person chooses as sources of knowledge and authority
- affects a person's view of every experience
- shapes a person's value system
- dominates a person's private and public life

Paul indicates that all mind-sets can be reduced to two categories: sinful and spiritual. The two mind-sets are not parts of a person or even forces within a person. They signify powers and dominant features of two realms, the spirit and the flesh (former sinful nature).

The sinful mind-set

Consciously and unconsciously life will be oriented toward:

- Death
- Hostility toward God
- Rebellion
- Resistance to any form of submission
- Actions and attitudes that will not please God

The spiritual mind-set

Consciously and unconsciously life will be oriented toward:

- Life and peace
- Friendship with God
- Obedience to the Spirit's influence
- Guidance by the Holy Spirit
- Love for God and neighbor
- Knowing and following the words of Jesus

Elsewhere in Scripture we find the characteristics of a mind under the Spirit's control.

- It will be a mind directed toward truth,
- aware of the Spirit's presence (**John 14:17**).
- It will be a mind seeking to please the Holy Spirit (**Galatians 6:8**).
- It will be a mind active in memorizing and meditating on the words of Christ (**John 14:26**).
- It will be a mind sensitive to sin (**John 16:7-11**).
- It will be a mind eager to follow the Spirit's guidance (**Galatians 5:16-22**).

The control of the Holy Spirit begins with voluntary commitment and submission to Christ.

How do we cooperate with the Spirit's control?

- Ask for greater openness and responsiveness to the Holy Spirit's guidance.
- Consciously humble ourselves before God, so we are not too proud to change.
- Look to God's Word for guidance.
- Obey where we have clear direction, so that our forward movement will enhance the Holy Spirit's leading. (It makes little sense to steer a parked car!)

How do we keep our obligation to the Spirit?

The Scriptures provide a picture of active response to God. This works out as we:

- Train ourselves in godliness. Our response to the gospel does not involve trying to live a certain way, but training to live in the way of the Spirit. Much of the training schedule is created by God, through suffering, perseverance, and development of self-control. But God's Word gives training disciplines for us to do. Prayer, study, meditation, service, confession, and worship are all chosen actions that demonstrate spiritual growth and form the basis for further spiritual growth.
- Constantly rely on the Holy Spirit. Even our efforts in training are not independent acts. Along the way, we need the Spirit's presence, guidance, comfort, and encouragement. One way or another, no matter how far we have travelled in life, the Holy Spirit will always bring us back to an awareness of the grace we have in Christ Jesus. There we find no condemnation.

Inappropriate Responses to the Misdeeds of the Body:

We should terminate the practices that the Holy Spirit points out as wrong. But instead, we often try to make excuses.

<i>Response</i>	<i>Example</i>
Denying that these habits or actions are part of our life	“I haven’t done or couldn’t do something like that.”
Disclaiming our knowing participation	“I wasn’t sure if it was right or wrong.”
Continuing to give in to those patterns	“I’m weak, but at least I’m being honest about it.”
Creating elaborate excuses	“I was deprived as a child. It’s not really a habit. I tried to resist.”
Minimizing or covering up the misdeeds	“At least I’m not as bad as she is.”
Hiding behind a facade of legalism	“I’m doing so many things right; those wrong things don’t count!”

John Toews: Paul’s logic in this text unit is both clear and complex. Sin caused death, and so prevented the law from giving life. The law exposed Sin, and so caused it to be focused and concentrated in one people and one place. Sin, collected in this one place, is dealt a decisive death-blow through God’s sending the Son in the likeness of sinful flesh. When God condemns Sin in the flesh of Christ on the cross, Sin is rendered powerless. The Spirit, of God and of Christ, becomes the power that makes possible law-fulfillment and gives new life. The power of Sin and flesh, which crippled the law as the midpoint between Grace and Sin, is overcome by the new mid-point, Christ and the Spirit. Liberation from Sin is possible, but not via the law. Rather, liberation is a function of Christ and the Spirit.

The structure of thought and the language is profoundly covenantal. The law is part of a covenant that was intended to give righteousness and life (**Deut. 30:15**). Messiah Jesus, the representative of Israel, fully identifies with humanity and fulfills the covenant; he does and completes the righteous requirement of the law (v. 4). Those in Christ and the Spirit, i.e., those who have covenant membership in the new covenant community, receive life and righteousness, literally, life because of righteousness (v. 10). The linkage of the gift of life to resurrection assures the ultimate vindication and hope of Israel. Those in whom Christ and the Spirit are present constitute the covenant people of God.

The view of the law is exceedingly positive. The questions of **7:7** and **7:13** are answered. The law is the law of God; it is holy, righteous, good, and spiritual. It is the covenant law for God’s people. The law is fulfilled through Christ and the Spirit. The new covenant people are the people whom the law fits. Paul really does build up the law (**3:31**).

The law is fulfilled and morality is possible, even necessary, through Christ and the Spirit. The

questions of **6:1** and **6:15** are answered by life in Christ and the Spirit. The new covenant given in Christ and the Spirit does not nullify the call of God for people to bound Sin and to be holy. On the contrary, the law is fulfilled and Sin and the flesh are defeated as people live in the power domain of the Spirit.

“As people live” is critical to the logic of Paul’s argument. Living according to the flesh is still a possibility. But it is not necessary because Sin dwelling in me is now replaced by Christ and the Spirit dwelling in me (three times, **vv. 9, 10, 11**). Choices have to be made—live in the worldview of the flesh or live in the Spirit. These choices have consequences—disobeying the law means death, fulfilling the law means life/peace.

Finally, the flesh/Spirit dualism extends the Adam/Christ contrast. Two opposing kingdoms are waging war. The language is apocalyptic, and comes specifically from Israel’s “holy war” tradition. Two representatives of the opposing armies face each other in behalf of their respective armies. The victor’s army is declared the winner in the war. Because Messiah Jesus condemned Sin in the flesh and the Spirit triumphs over the flesh, those in Christ and the Spirit share the victory.

Steven Cole: THERE ARE DISTINGUISHING MARKS BY WHICH YOU CAN TELL IF THE SPIRIT DWELLS IN YOU.

After speaking to Nicodemus about the new birth, Jesus drew an analogy between the effects of the wind and the effects of the Holy Spirit. We can’t see the wind, but we can see its effects. When a piece of paper blows by, you do not assume that it is flying on its own like a bird. You assume that the wind is blowing it. So it is with the Spirit. You can’t see the Spirit, but you can see His effects.

In **Romans 8**, Paul shows a number of things that the Spirit does. He sets you free from the law of sin and of death (**8:2**). He gives new life and peace with God (**8:6**). The Spirit will raise our mortal bodies (**8:11**); He enables us to kill our sin (**8:13**); testifies to us that we are God’s children (**8:16**); and, helps us to pray (**8:26**). And, by way of implied contrast (**8:7-8**), the Spirit reconciles us to God and enables us to submit to His Word and to please Him.

I can’t comment much and this list is not comprehensive, but here is one negative and nine positive marks by which you can tell if the Spirit dwells in you:

(1). SPEAKING IN TONGUES IS NOT A SIGN THAT THE SPIRIT DWELLS IN YOU. I must point this out because some Pentecostal denominations claim that speaking in tongues is the sign that you have the Holy Spirit. But this is contrary to Paul’s statement that all do not have the gift of tongues (**1 Cor. 12:30**). It’s debatable whether or not the gift of tongues is valid for today. But if it is valid, it must be translatable language, not babble. You cannot interpret or translate babble. It’s just nonsense syllables. Language has definable structure and vocabulary. The biblical gift of tongues is the miraculous ability to speak in a language that you have not learned so that a speaker of that language could understand you. But most of what is called tongues today is just nonsense syllables. Non-Christians have experienced the same phenomena, obviously without the power of the Holy Spirit. Positively,

(2). IF THE SPIRIT DWELLS IN YOU, YOU HAVE EXPERIENCED THE NEW BIRTH. You may not remember the exact time or place, but you know that the Spirit of God has changed your heart from being a God-hater to being a God-lover. He changed you from trusting in your own good works to trusting in Christ alone.

(3). IF THE SPIRIT DWELLS IN YOU, YOU ARE DRAWN TO JESUS CHRIST AND YOU DESIRE TO KNOW AND HONOR HIM (**JOHN 16:14-15; EPH. 3:16-17**).

(4). IF THE SPIRIT DWELLS IN YOU, YOU HAVE BEEN FLOODED WITH GOD'S LOVE SO THAT YOU HAVE HOPE IN HIM (**ROM. 5:5; 15:13**).

(5). IF THE SPIRIT DWELLS IN YOU, YOU REGARD SCRIPTURE AS HIS WORD OF TRUTH AND YOU ARE GROWING TO UNDERSTAND IT. Jesus calls Him "*the Spirit of truth*" (**John 14:17; 15:26**). He inspired the writers of Scripture (**2 Pet. 1:21; 2 Tim. 3:16**). He helps us to understand the many riches that God gives us through the written Word (**1 Cor. 2:10-16**).

(6). IF THE SPIRIT DWELLS IN YOU, HIS FRUIT IS GROWING IN YOUR LIFE AND THE DEEDS OF THE FLESH ARE DIMINISHING. Fruit takes time, but it should be evident that you are growing in love, joy, peace, patience, kindness, goodness, faithfulness, gentleness, and self-control (**Gal. 5:22-23**).

(7). IF THE SPIRIT DWELLS IN YOU, YOU WILL HAVE A GROWING HATRED OF SIN AND LOVE OF HOLINESS. He is the *Holy Spirit*. He works to make us holy (set apart from this evil world), beginning on the thought level (**1 Cor. 6:11, 19; 2 Cor. 3:18; Rom. 14:17; 1 Thess. 4:7-8**).

(8). IF THE SPIRIT DWELLS IN YOU, YOU WILL BE GROWING IN PRAISE, JOY, AND THANKFULNESS TOWARD GOD (**LUKE 1:67FF; 2:26-32; 10:21; ACTS 13:52; EPH. 5:18-20; PHIL. 3:3**).

(9). IF THE SPIRIT DWELLS IN YOU, YOU WILL BE GROWING IN PRAYER (**ROM. 8:26; EPH. 6:18; JUDE 20**).

(10). IF THE SPIRIT DWELLS IN YOU, YOU WILL TELL OTHERS ABOUT CHRIST. **Acts 1:8**: "*But you will receive power when the Holy Spirit has come upon you; and you shall be My witnesses....*" The Book of Acts is the story of the early church bearing witness of Jesus and the resurrection through the Spirit's power.

Leedy Greek NT Diagrams:

Rom 8:5

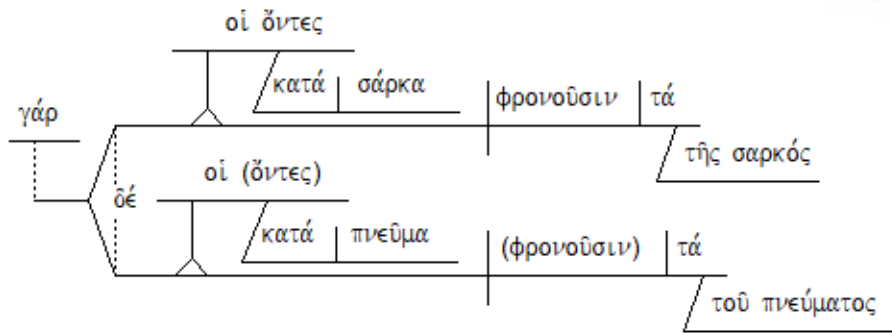

Rom 8:6-8

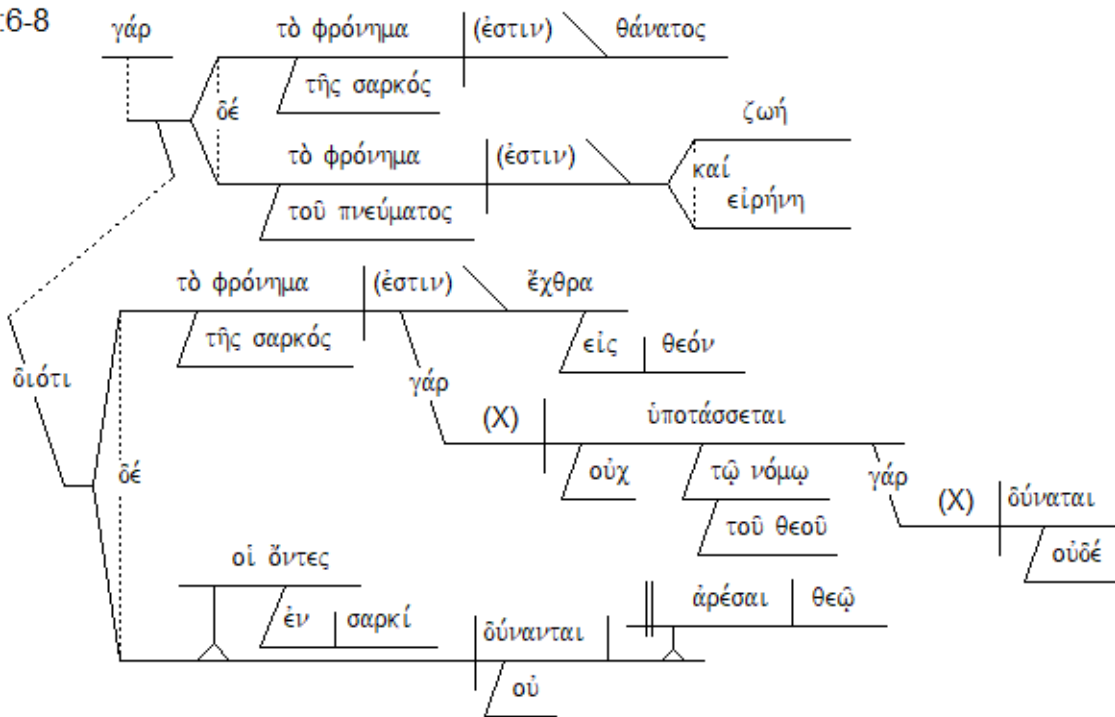

Rom 8:9

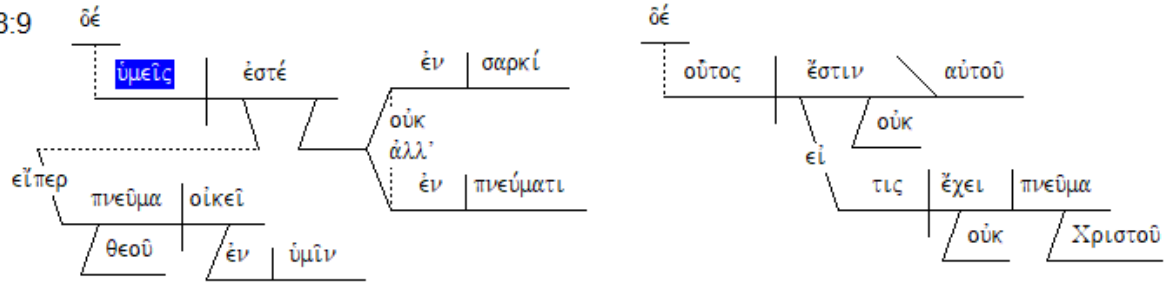

Rom 8:10

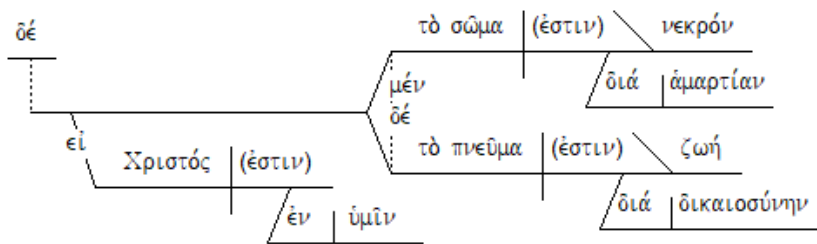

Rom 8:11

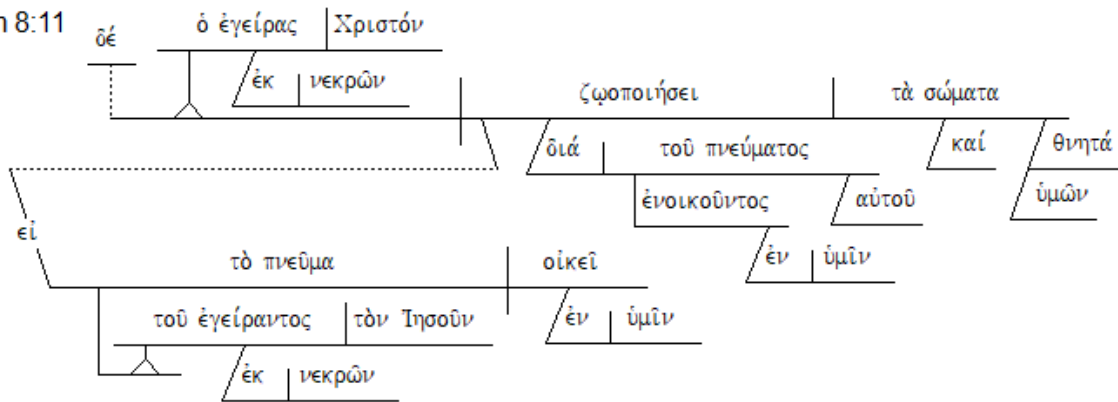

Rom 8:12-13

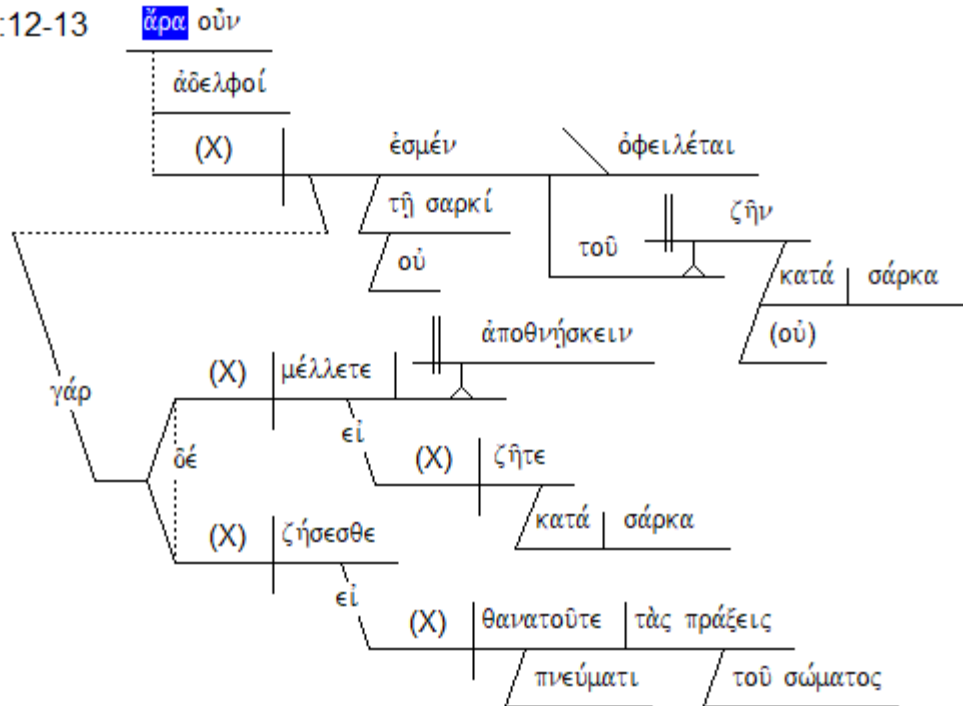

Frank Thielman:

- 5a Explanation (of 4a) For **those who exist according to the flesh** agree with the flesh,
 b Contrast (to 5a) but **those who exist according to the Spirit** agree with the Spirit.
- 6a Explanation (of 5a–b) For **the mindset of the flesh** is death,
 b Contrast (to 6a) but **the mindset of the Spirit** is life and peace.
- 7a Basis (of 6a–b) Because **the mindset of the flesh is hostility against God**,
 b Cause (of 7a) for **it does not submit to the law of God**,
 c Cause (of 7b) for **it is not able**.
- 8 Explanation (of 7b) And **those who are in the flesh are not able to please God**.
- 9a Contrast (to 8) **You**,
 however, **are not in the flesh but in the Spirit**,
- b Verification (of 9a) if indeed the Spirit of God dwells within you.
- c Verification (of 9d) And if anyone does not have the Spirit of Christ,
 d Expansion (of 9a) **this person is not his**.

- 10a Verification (of 10c) But if Christ is in you,
 b Contrast (to 10c) although the body is a dead thing because of sin,
 c Contrast (to 9c) **the Spirit is life because of righteousness.**
- 11a Verification (of 11b) And if the Spirit ...
 b of the one who raised Jesus \leftrightarrow
 c from the dead
 ... dwells in you,
 d Explanation (of 10c) **the one who raised Christ from the dead will also give life**
 e Indirect Object to your mortal bodies
 f Means through his Spirit that indwells you.
- 12 Conclusion (from 1–11) So then, **brothers and sisters, we are debtors not to the flesh to live according to the flesh.**
- 13a Condition (of 13b) For if you live according to the flesh,
 b Explanation (of 12) **you are about to die,**
 c Condition but if, by the Spirit, you put to death the deeds of the body,
 d Contrast (to 13b) **you will live.**

TEXT: ROMANS 8:14-17

TITLE: ASSURANCE FROM WITHIN – IDENTITY / INTIMACY / INHERITANCE

BIG IDEA:

**OUR HEAVENLY FATHER GAVE US HIS SPIRIT TO REASSURE US
OF OUR PRIVILEGED FAMILY IDENTITY AND GLORIOUS INHERITANCE**

INTRODUCTION:

Frank Thielman: Paul wants the Romans to understand that God has adopted them into his family, giving them the status of highly privileged children within it (8:15). Their status as sons and daughters of God is similar in important ways to Jesus’s own status as God’s Son. When they experience physical and emotional suffering, just as Jesus did before his passion, they too can cry out to God as their Father (Mark 14:36; cf. Rom 8:15). Their status as God’s adoptive sons and daughters is a sign of God’s love and permanent commitment to them, both now, in the midst of their suffering, and in eternity when they will share the family “inheritance” of a fully restored creation (8:17; cf. 8:23).

Michael Bird: By v. 13 Paul has finished his demarcation of the two opposing forces of redemptive history, **Spirit** and **flesh**, where he placed believers on the side of the Spirit. Christians, therefore, are those who are indwelt by the Spirit of Christ, who have been set free from sin and death, and who are empowered to resist the flesh. What we find in vv. 14-17 is a transitional passage that uses the theme of adoption to move between the Spirit/flesh contrast of vv. 1-13 to the following section on the future dimension of Christian hope in vv. 18-39. The substance of vv. 14-17 is that those led by the Spirit are adopted as children of God. Such adoption brings a new status, it provides an intimate relationship with God, and it secures a glorious future as co-heirs with Christ in glory.

I. (:14-15) ASSURANCE BASED ON IDENTITY AS ADOPTION AS SONS

A. (:14) Inclination to Please God

“For all who are being led by the Spirit of God, these are sons of God.”

Grant Osborne: The Jews already considered themselves to be “*sons of God*” because of their heritage; but Paul explains that sons of God has new meaning. True sons of God are those who are led by the Spirit of God as evidenced in their **lifestyle**. Believers not only have the Spirit (8:9); they are also **led by the Spirit**.

Frank Thielman: The passive verb “*led*” (ἄγονται) is a forceful term that Paul could use elsewhere of people “*led*” to stray after idols (1 Cor 12:2) or to give in to sinful desires (2 Tim 3:6). It was sometimes used in antiquity to refer to the **compulsion to act on a particular inner feeling such as desire or pleasure** (Euripides, Med. 310; Plato, Prot. 355a). This does not mean that those “*led by the Spirit of God*” were forced by God’s Spirit to act in certain ways. Paul could use the same term to speak of disobedient people being unaware that God was trying

to lead them to repentance (2:4), and **Plato**, using the exact grammatical construction Paul uses here (the passive verb with a dative of means), could speak of desires that are “directed by calculation” (λογισμῶ ἄγονται). Paul’s meaning is that the Spirit helps those in whom he dwells to make decisions about their behavior that please God rather than decisions that give in to the sinful desires of the flesh (cf. **Gal 5:17–18**).

John Murray: The connection between this verse and the preceding is as follows. Those who by the Spirit put to death the deeds of the body are led by the Spirit of God. But those who are led by the Spirit of God are the sons of God. And, if they are the sons of God, that status is the guarantee of eternal life. **Verse 14** is, therefore, to be interpreted as providing the basis for the assurance given in **verse 13**, namely, “*ye shall live*”, the specific consideration being that **eternal life is the invariable issue of sonship**. It is taken for granted that those who by the Spirit put to death the deeds of the body are led by the Spirit of God and it is categorically asserted that as many as are led by the Spirit these are the sons of God. “*Led by the Spirit*” implies that they are **governed by the Spirit** and the emphasis is placed upon the activity of the Spirit and the passivity of the subjects. “*Put to death the deeds of the body*” (**vs. 13**) emphasizes the activity of the believer. These are complementary. The activity of the believer is the evidence of the Spirit’s activity and the activity of the Spirit is the cause of the believer’s activity.

Douglas Moo: In popular speech, Christians often use language such as “*led by the Spirit*” to refer to **guidance**: “I was led by the Spirit to witness to her.” But this is **probably not what Paul means here**. As in **Galatians 5:18**, where the same construction occurs, “*being led by the Spirit*” means “**having the basic orientation of your life determined by the Spirit**.” The phrase is a way of summing up the various descriptions of the life of the Spirit in **8:4–9**.

B. (:15) Intimate Family Relationship of Privileged Position

1. Not a Relationship of Slavish Fear

“For you have not received a spirit of slavery leading to fear again,”

John Murray: The **implications of sonship** are now unfolded. . . The reception of the Holy Spirit does not have the effect of a relapse into that slavish fear which characterized the pre-Christian state, and the reason for this is that the Holy Spirit is not the Spirit of bondage but of adoption, the Spirit whose activities are promotive of what is consonant with adoption, not with what is symptomatic of bondage.

John Toews: A slave is not in control of life, but lives at the mercy, and thus fear, of someone else.

Michael Bird: Many of the Roman Christians, who were either slaves or former slaves, knew all too well that slavery was a state of living death. Slavery meant being treated like a piece of furniture with a soul, yielding up one’s body to whatever task or torment that a master demanded. Although the fortunes of slaves were mixed depending on the household and the particular purpose of the slave, generally speaking, slavery was defined by servility and suffering.

2. But a Relationship of Confident Sons

“but you have received a spirit of adoption as sons by which we cry out, ‘Abba! Father!’”

Westminster Confession (chapter 12) – **Definition of Adoption:**

All those that are justified, God vouchsafeth, in and for His only Son Jesus Christ, to make partakers of the grace of adoption: by which they are taken into the number, and enjoy the liberties and privileges of the children of God; have His name put upon them, receive the Spirit of adoption; have access to the throne of grace with boldness; are enabled to cry, *Abba, Father*; are pitied, protected, provided for, and chastened by Him, as by a father; yet never cast off, but sealed to the day of redemption, and inherit the promises, as heirs of everlasting salvation.

Douglas Moo: What is most important is that the Spirit enables us to experience the same kind of intimate relationship to the Father that Jesus did, who also called God “*Abba*” (**Mark 14:36**). Not only does the Spirit confer on us this status; he also is the one who, testifying with our own spirits, gives us the **inner certainty** of knowing that we truly are God’s dearly loved children.

Frank Thielman: In the Roman world, social elites often used adoption to procure successors to carry on the family name and cult. The adoptee frequently received a higher social status and increased honor through the adoption. Paul’s audience in Rome, many of whom probably occupied the social status of slaves, freedmen, and foreigners, would have heard as good news indeed that they were the adoptive sons of the one true God. Only a few years prior to Paul’s letter, in AD 50, the emperor Claudius had adopted eleven-year-old Nero, and Nero had been proclaimed across the empire as “son of the greatest of the gods, Tiberius Claudius.”

The Spirit enables believers to “cry” (κράζω) to God for help in the midst of difficulty, just as any child might appeal to a loving father for help, and just as Jesus appealed to God shortly before his arrest, torture, and execution (**Mark 14:36**; cf. **Gal 4:6**). The use of Aramaic, which was Jesus’s native tongue, and the immediate translation of the term into Greek imply that Jesus’s use of “*Abba*” to address God was a widely known characteristic of his familiar relationship with God. Paul now says that believers have this same level of familiar access to God (cf. **5:2**; **Eph 2:18**).

John Murray: In **Rom. 8:15** “*the Spirit of adoption, whereby we cry, Abba, Father*” is the Holy Spirit. He is called “*the Spirit of adoption*”, not because he is the agent of adoption but because it is he who creates in the children of God the filial love and confidence by which they are able to cry, “*Abba, Father*” and exercise the rights and privileges of God’s children.

Marvin Vincent [quoting **Merivale**]: The process of legal adoption by which the chosen heir became entitled not only to the reversion of the property but to the civil status, to the burdens as well as the rights of the adopter—became, as it were, his other self, one with him ... this too is a Roman principle, peculiar at this time to the Romans, unknown, I believe, to the Greeks, unknown, to all appearance, to the Jews... We have but a faint conception of the force with which such an illustration would speak to one familiar with the Roman practice; how it would serve to impress upon him the assurance that the adopted son of God becomes, in a peculiar and intimate sense, one with the heavenly Father.

F. F. Bruce: The term “*adoption*” may smack somewhat of artificiality in our ears; but in the first century A.D. an adopted son was a son deliberately chosen by his adoptive father to perpetuate his name and inherit his estate; he was no whit inferior in status to a son born in the ordinary course of nature and might well enjoy the father’s affection more fully and reproduce the father’s character more worthily.

William Barclay: It is the consequences of adoption which are most significant for the picture that is in Paul’s mind. There were four main ones.

- (i) Adopted person lost all rights in his old family and gained all the rights of a legitimate son in his new family. In the most binding legal way, he got a new father.
- (ii) It followed that he became heir to his new father’s estate. Even if other sons were afterwards born, it did not affect his rights. He was inalienably co-heir with them.
- (iii) In law, the old life of the adopted person was completely wiped out; for instance, all debts were cancelled. He was regarded as a new person entering into a new life with which the past had nothing to do.
- (iv) In the eyes of the law he was absolutely the son of his new father. Roman history provides an outstanding case of how completely this was held to be true.

II. (:16) ASSURANCE BASED ON INTIMACY OF INDWELLING HOLY SPIRIT CONFIRMING OUR IDENTITY AS CHILDREN OF GOD

“The Spirit Himself bears witness with our spirit that we are children of God,”

John Murray: Now in **verse 16** it is the witness borne by the Holy Spirit himself. And this latter witness is conceived of as working conjointly with the witness borne by the believer’s own consciousness. The Spirit’s witness must, therefore, be distinguished from the witness of our filial consciousness. It is a witness given to us as distinct from the witness given by us. The witness thus given is to the effect that “*we are children of God*”.

John Toews: In Judaism, two witnesses were needed to establish something. Here the two witnesses are the Spirit of God and the spirit of believers.

III. (:17) ASSURANCE BASED ON PROMISED GLORIOUS INHERITANCE

A. Promised Future Heirs with Christ

“and if children, heirs also, heirs of God and fellow heirs with Christ,”

Douglas Moo: Paul reminds us, we Christians must still await the consummation of that new status. One day we will enter into the inheritance, following the Son who has gone ahead of us. We will share in his own glorious state. In the meantime, however, we must follow him in the road he himself walked on the way to glory—the **road of suffering**.

Stan Mast: In the rich language of **verse 17**, Paul goes on to elucidate just how near and dear we are. It's conceivable that adopted children would not be treated the same as natural born children. Blood can be thicker than legal papers. We've all heard of adoptions that never work, that go bad and are terminated because adoptee and adopted parents cannot bond. Then the adoptee is cut off from all the rights and privileges of being part of that family. That cannot happen to followers of Christ, says Paul. The adopting work of the Triune God is effective and permanent.

<https://cepreaching.org/commentary/2015-05-25/romans-812-17-2/>

B. Present Suffering with Christ in Anticipation

“if indeed we suffer with Him in order that we may also be glorified with Him.”

Frank Thielman: A condition is implied (those who do not suffer with Christ are not his coheirs), but that is not where the emphasis lies. Instead Paul emphasized that those who, because of their commitment to the gospel, share the physical pain and public shame that Christ endured when he was crucified will also experience the vindication and release from pain that he experienced when he was raised from the dead (cf. **2 Cor 4:10–11; Phil 3:20–21**). Paul had said earlier in the letter that all had sinned and lacked “*the glory of God*” (**3:23**). Now he shows that through their union with Christ this lack will be supplied. This is the “*hope of glory*” that Christian suffering instills in the believer according to **5:2–4**.

John Murray: “*If so be that we suffer with him, that we may be also glorified with him*” is the **condition** upon which the attainment of the inheritance is contingent (cf. **vs. 9**). There is no sharing in Christ's glory unless there is sharing in his sufferings. Sufferings and then glory was the order appointed for Christ himself. It could not have been otherwise in terms of his messianic undertaking and design (cf. **Luke 24:26; Phil. 2:6–11; I Pet. 1:11**). The same order applies to those who are heirs with him. It is not only, however, that they must suffer and then enter glory; it is more than a parallelism of order. It needs to be noted that they suffer with him and this joint participation is emphasized in the case of suffering as it is in the case of glorification. This is both the reason for and the import of the emphasis which is placed in the New Testament and particularly in Paul upon the sufferings of the people of God as the sufferings of Christ (cf. **II Cor. 1:5; Phil. 3:10; Col. 1:24; II Tim. 2:11; I Pet. 4:13; cf. Mark 10:39**). Believers do not contribute to the accomplishment of expiation, propitiation, reconciliation, and redemption. Nowhere are their sufferings represented as having such virtue or efficacy. The Lord laid his people's iniquities upon Christ alone and in him alone did God reconcile the world to himself. Christ alone redeemed us by his blood. Nevertheless there are other aspects from which the sufferings of the children of God are to be classified with the sufferings of Christ himself. They partake of the sufferings which Christ endured and they are regarded as filling up the total quota of sufferings requisite to the consummation of redemption and the glorification of the whole body of Christ (cf. **Col. 1:24**). Again union and communion with Christ are the explanation and validation of this participation.

John Toews: Paul adds a shocker in **v. 17b**. The glory of the inheritance is qualified by a strong “*if*” clause (lit., “*if indeed*”). The *if indeed we suffer with in order that we may be glorified with* takes up an established link between child status and suffering in Judaism, and applies it to Christians. Jews know that they suffer because of their unique relationship to God. Paul asserts

that the reality of suffering goes with the privileged inheritance of being a child of God. The term to suffer with means to suffer the same thing as. Just as Christians die with Christ in baptism (**ch. 6**), so also they participate in the suffering that characterizes the current age of the rule of Sin. Furthermore, the suffering is **life-long** (the verb is present tense). The purpose of the suffering is defined by a purpose clause, *in order that we may be glorified with*. Suffering with Christ is not optional; no suffering, no future glory. The future glory describes the radiance of God. It characterizes God's original creation, which was lost by Adam and will be restored in the end-time through Messiah Jesus.

* * * * *

DEVOTIONAL QUESTIONS:

- 1) How do you approach God from the perspective that He is your father?
- 2) How sensitive are you to the internal witness of the Holy Spirit?
- 3) How does your eternal inheritance impact your ambition to possess material riches in this life?
- 4) How do the **tests of 1 John** contribute to your understanding of assurance of salvation?

* * * * *

QUOTES FOR REFLECTION:

John Toews: This **family terminology** is significant for Paul's audience. To be *children of God* is the unique privilege of Israel in the OT and Judaism (see, e.g., **Exod. 4:22-23; Deut. 14:1; 32:56; Isa. 1:2-4; 30:9; 63:8; Hos. 1:10; 11:1; Wis. 12:7, 21; 16:10, 21, 26; 18:13; 19:6; Sir. 36:17; 1 En. 62:11; Jub. 1:24-25; 2:20; Pss. Sol. 17:30; As. Mos. 10:3, 4; Sib. Or. 3:702; 5:202; 3 Macc. 6:28**). This status, linked to election and calling, is what distinguished Israel from the nations. *Children of God* is synonymous with *people of God*. The language applied especially to Jews in apocalyptic literature. Sonship became synonymous with righteous. The ones made righteous are the *children of God*, and the children of God are the righteous ones. . .

Together with v. 9, Paul is defining the Christian life in terms of **life in the Spirit** and the new status of a **family relationship with God**.

Michael Bird: Anxiety and Assurance

Paul's climactic assertion is that for those in Christ there is "*no condemnation*." The verdict of the final day has been declared and the verdict is "righteous" for those belonging to Christ. The verdict cannot be changed, and thus we face the judgment day with complete assurance that what lies ahead of us is not a life-or-death assessment of our deeds but the divine disclosure of our acquittal.

The concept of assurance is close to the heart of the Protestant faith. Indeed, for the Reformers, a major part of their protest against medieval Catholicism was their claim that it was possible for persons to have a complete sense of assurance that the Father loved them, the Spirit was in them, and Christ truly died for them. They could really, truly, deep down, and fully know without any hesitation that they were saved. God's love in Christ, stretching from eternity to eternity, had seized hold of them and would never let them go. Such assurance was the joy and comfort of those who believed in Jesus Christ. The ground of assurance is not in ourselves or even in our experiences, but in the gospel, in the grace offered us in Christ, and in the mercy of God. We can rest rather than be restless about our eternal state. We can have assurance rather than carry anxiety about the future. We can be at peace rather than worry ourselves to pieces about how it will turn out for us before our Judge and Maker. We can take our final breath knowing that all will be well.

It was this apparently outrageous and assumptive claim to complete assurance that Roman Catholic theologians found highly objectionable. Cardinal Robert Bellarmine (1542 – 1621) was a key Catholic figure during the European Reformation. He was Pope Clement VIII's personal theological advisor and one of the most capable leaders in the Counter-Reformation movement within sixteenth-century Roman Catholicism. According to Bellarmine, "the greatest of all Protestant heresies is assurance." His fear was that such a doctrine would give license to sin and promote antinomianism. Later the Council of Trent (1545 – 63) recognized the rich nature of God's mercy and the efficacy of Christ's blood, but it still claimed in one of its sessions that "no one can know with the certainty of faith, which cannot be subject to error, that he has obtained the grace of God."

The retort of the Reformers, incipiently channeling the message of children's cartoon character Bob the Builder, was "Yes, we can!" We can know for sure that we have obtained the grace of God. The Reformed and evangelical churches — with several variations on the theme among Wesleyans, Baptists, Lutherans, and Presbyterians — have normally maintained that Christian believers can have full and confident assurance of their standing in God's mercy and grace. Such is the "blessed assurance" that Christ is mine and I am his for all eternity.

But what if I or someone I know struggles with assurance? It is true that there are some people out there with a sham faith who probably should struggle with assurance. In those instances a little bit of self-examination and asking themselves if they are truly living in the faith is a genuinely good idea (see **2 Cor 13:5**). Such persons need to stop sitting on the fence and take faith and its consequences seriously. Nevertheless, there are plenty of people who really should feel the comfort of their heavenly Father's joy in them because they have entrusted themselves to the one who died and rose for them.

In those instances where people with genuine faith wrestle with spiritual insecurity about their standing before God, I usually take the following approach. First, I ask them, "Do you have any love for God? However imperfect or incomplete, is there any love for God in you?" Normally they answer "yes, some love I guess." Next, I tell them that loving God is something that God himself enables us to do. It does not come from depraved humanity, but derives from the love that God dispenses and decants into our heart from heaven. This is precisely what Paul says: "*God's love has been poured out into our hearts through the Holy Spirit, who has been given to*

us” (Rom 5:5). Similar is 1 John 4:7: “Dear friends, let us love one another, for love comes from God. Everyone who loves has been born of God and knows God.” So my love for God is proof that God loves me! Obviously there are other issues we could broach, like our obligation to love others, how doubt and repentance fit into the normal Christian life, and so forth. Suffice to say for now, we should remember that our affection for God is the affective work of the Holy Spirit, who draws us to love God and to love others in the name of Jesus Christ.

Steven Cole: In the New Testament, assurance rests on three pillars.

First, have you abandoned all trust in your own good works so that you’re trusting in Christ alone for right standing before God? If you answer yes, then the question arises, “How do you know that your faith is genuine saving faith?”

That leads to the second pillar: If your faith is genuine, then you possess new life in Christ and that new life always manifests itself in changed thinking and behavior. There will be evidence in your life that God has changed your heart. You love God and desire to love Him more. You want to please Him by a life of obedience to His Word. You hunger to feed on His Word. You’re growing in godly character and behavior, as summed up by the fruit of the Spirit.

The third pillar is the inner witness of the Holy Spirit, who testifies that we are children of God (8:16). Although some would dispute any subjective element in this, it seems to me that this is a subjective, experiential matter. But, as I will explain, it is based on the objective promises of the gospel as revealed in God’s Word. In our text, Paul is giving us the signs of true assurance: If the Spirit is leading us to kill our sin and confirming to us the promises of the gospel, then we can be assured that we are children of God.

Arland Hultgren: The word “Abba” is an **Aramaic term** for father. It is less formal than “Ab,” which also means father. But Abba was usually the word used in the home, as children addressed their fathers. It is easier for a child to use a two-syllable word ending in a vowel than to use a single syllable word ending with a consonant. (So “Daddy” is easier to say than “Dad,” “Mommy” is easier than “Mom,” and so on.) But of interest here also is that “Abba” is the word used by Jesus in the crucifixion scene in the Gospel of Mark (14:36, “Abba, Father, for you all things are possible ...”). The use of “Abba” must also have been characteristic of Jesus’ prayers, as in the use of “Father” in the Lord’s Prayer (Matthew 6:9; the Greek *pater* of the prayer is probably a translation of the Aramaic Abba). Apparently the term was familiar to the Christians at Rome as well as for Paul and for the Christians in Galatia. It is generally held that the term was used as a liturgical term to address God, first by Aramaic-speaking Christians and then, untranslated, by Greek-speaking Christians. That would have been in imitation of the prayer language of Jesus. To be sure, both Mark and Paul add “Father” after the term (so “Abba, Father”). It is possible that use of the Aramaic term was passing by the time that those writers wrote, and so it had to be translated for later and broader audiences. On the other hand, the addition of “Father” (*pater*) may have been primarily for emphasis.

<https://www.workingpreacher.org/commentaries/revised-common-lectionary/the-holy-trinity-2/commentary-on-romans-812-17-3>

Leedy Greek NT Diagrams:

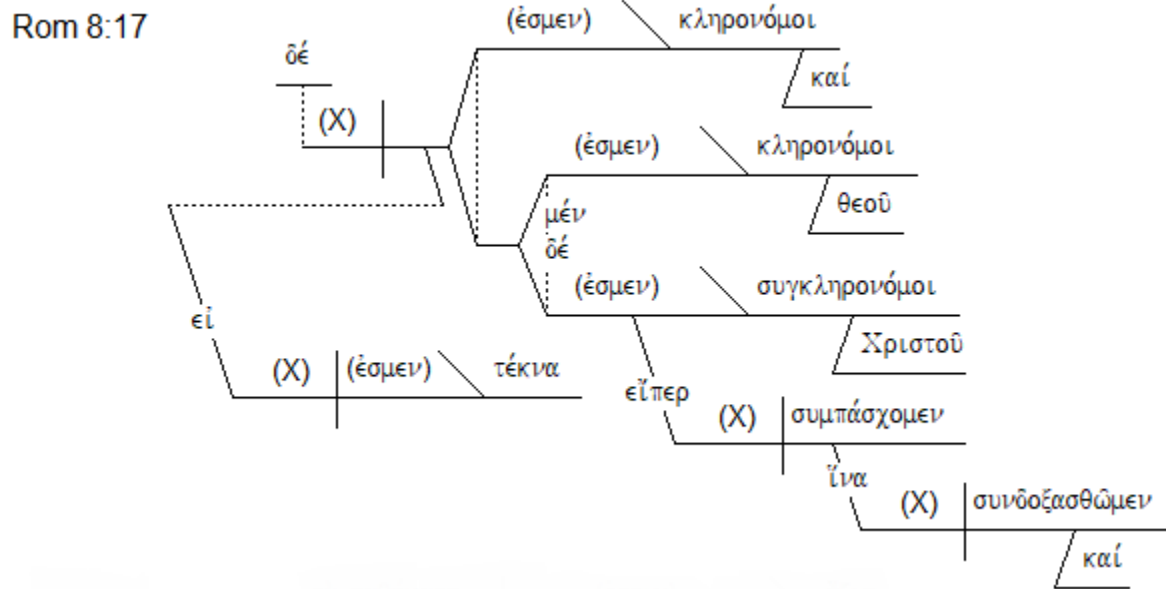
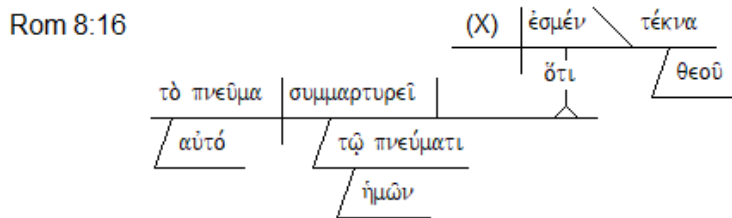
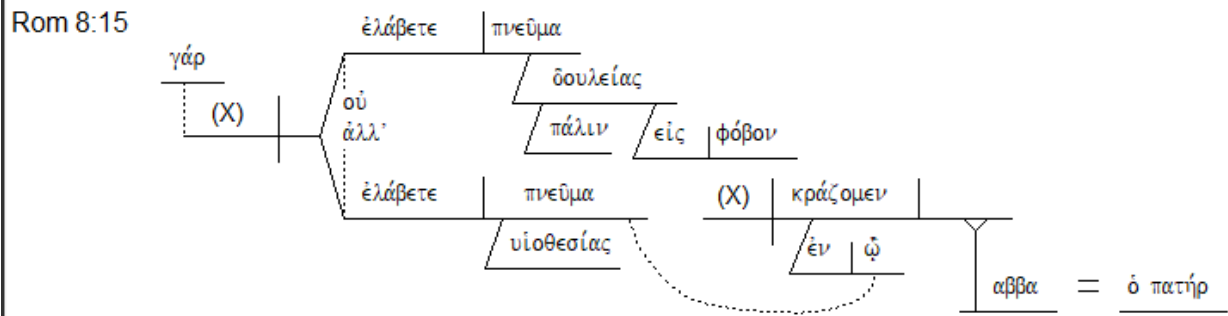
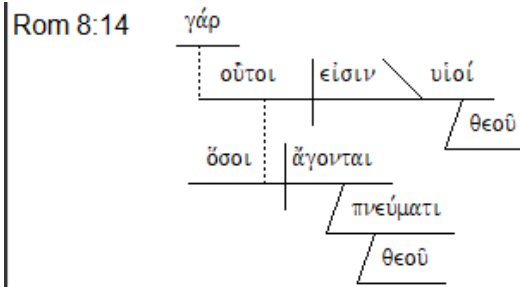

Frank Thielman:

- 14a Basis (for 13d) For **all**
b Identification 1 **who are led by the Spirit of God,**
c Description **these are sons of God.**
d Identification 2
- 15a Explanation (of 14) For **you did not receive a spirit of reenslavement,**
with fear as the result,

b Contrast (to 15a) but **you received the Spirit**
c Description of adoption as a son,
d Agent by which we cry, "Abba," that is, "Father."
- 16a Assertion **The Spirit himself bears witness together**
b with our spirit
c that we are the children of God and
- 17a Verification (of 17b) if children, also
b Inference (16, 17a) heirs;
c Restatement (of 17b) heirs of God and
d Restatement (of 17c) fellow heirs of Christ,

e Condition (of 17b) if indeed we suffer
f Association with him
g Result (of 17c) so that we might be glorified with him.

TEXT: ROMANS 8:18-25

TITLE: PERSPECTIVE TOWARDS SUFFERING

BIG IDEA:

WE CAN PATIENTLY ENDURE SUFFERINGS BECAUSE OF OUR SURE HOPE THAT THEY WILL END IN A FAR SURPASSING GLORY

INTRODUCTION:

John Toews: Paul introduces the **thesis** by setting in confrontation the present reality of suffering and future glory. The suffering Christians experience in the present age (lit., “*the now time*”) cannot be compared with the end-time glory to be revealed.

Paul explains the thesis in three subunits that deal with creation (vv. 19-22), Christians (*we*, vv. 23-25), and the Spirit (vv. 26-30). Recurring words and themes run through these sections: groaning (vv. 22, 23, 26), hope (vv. 20, 24, 25), expectation (vv. 19, 23, 25), children of God (vv. 19, 21, 23, 29). The whole is tied together by the keyword *groaning* (*stenazein*). Each subunit has its own theme: freedom versus slavery (vv. 19-22), eager expectation sustained by hope (vv. 23-25), the intercession of the Spirit for the Christian (vv. 26-30).

Michael Bird: The unstated question, though, is that if believers have been freed from the “*law of sin and death*,” why does death still engulf them? If believers have a share in the glory of Christ, where is this glory now?

Paul anticipates this question and reminds his audience of the “not yet” of Christian hope and turns their gaze on the future horizon of divine glory. In the midst of the sufferings of the present time, there remains a longing for a future glory that will be revealed in us, which will redeem our bodies, heal the wounded creation, and seal our adoption. The gist of vv. 18 – 30 is that believers must walk in the footsteps of the Lord and travel the path of suffering before entering into glory (see 2 Cor 4:17). Moo is right that Paul “assumes the fact of suffering as the dark backdrop against which the glorious future promised to the Christian shines with bright intensity.”

In terms of structure,

- (1) Paul opens with mention of present sufferings in the context of the groaning of creation (vv. 18 – 22);
- (2) then he refers to the groaning of Christians who wait in hope for their final salvation (vv. 23 – 25);
- (3) Paul next comments about the groaning of the Spirit who intercedes for the saints in the interim period (vv. 26 – 27); and
- (4) he describes how God’s goodness prevails for those who love him (vv. 28 – 30).

Michael Gorman: The second half of **Rom 8** is among the most moving parts of the Bible, culminating in 8:31–39, “one of the most stunning pieces of rhetorical art in the New Testament.” Paul puts the suffering of the faithful into the larger context of the suffering of the

entire creation and the hope of future salvation. He portrays the story of the universe as a **dramatic sequence**:

- human sin
- creation's subjection and decay
- believers' present experience of the Spirit in the midst of suffering
- believers' final glorification and salvation
- the liberation and salvation of all creation

Paul contends that life in the Spirit—life in Christ, life as God's children—is indeed a life of suffering, but also that no suffering can destroy believers' hope of glory or separate them from God's love in Christ.

I. (:18) FUTURE GLORY FAR SURPASSES PRESENT SUFFERING

“For I consider that the sufferings of this present time are not worthy to be compared with the glory that is to be revealed to us.”

We need to reckon our share in sufferings to be insignificant compared to our share in glory.

Bruce Hurt: *Logizomai* was a term frequently used in the business community of Paul's day and meant to impute (put to one's account) or credit to one's account. *Logizomai* is related to our English term logic (which deals with the methods of valid thinking, reveals how to draw proper conclusions from premises and is a prerequisite of all thought).

Michael Bird: When it comes to future glory outweighing current hardship, Paul expressed a similar thought in **2 Corinthians 4:17**: *“For our light and momentary troubles are achieving for us an eternal glory that far outweighs them all.”* Even more elegant is **Theresa of Ávila**: “In light of heaven, the worst suffering on earth will be seen to be no more serious than one night in an inconvenient hotel.”

Grant Osborne: Suffering is part of the process of sharing in Christ's death; it will culminate in sharing his glory. If glory is the majesty of God, his character seen for all that it truly is, then his glory . . . revealed in us will occur when we suddenly become exactly what God has intended us to be. God will allow us to share in the glory that belonged to Christ alone. We will share with Christ in the glory of sonship. In that day we will fully reflect God's image.

II. (:19-22) FRACTURED CREATION LONGS FOR END TIME REDEMPTION

A. (:19) Anxious Anticipation

“For the anxious longing of the creation waits eagerly for the revealing of the sons of God.”

Michael Bird: The reason why creation is anxiously awaiting the revelation of God's sons to be revealed is because it knows that once they are revealed in the resurrection, creation itself is next in line to receive release from the mire of corruption.

R. Kent Hughes: In verse 19 the phrase “*waits with eager longing*” comes from a group of words that carry the idea of craning the neck or stretching forward. Here the form of the word is intensive. **Phillips** translates this, “*The whole creation is on tiptoe to see the wonderful sight of the sons of God coming into their own.*” Creation longs for the day of liberation.

Douglas Moo: Interpreters debate just what this “*creation*” (*ktisis*) might refer to. Because he speaks so personally (e.g., in v. 22, *it groans*), many think he is referring only to human beings, or perhaps to unbelievers. Paul can use the word to refer to human “creatures” (**Gal. 6:15; Col. 1:23**), but he usually applies it to **God’s entire creation (Rom. 1:20, 25; 8:39; 2 Cor. 5:17; Col. 1:15)**. The key to its meaning here is the fact that Paul insists that the frustration “*creation*” is experiencing is **not its own fault**. We must, therefore, exclude all human beings, since they all had a part in the Fall. With most modern commentators, we conclude that Paul refers to **all of subhuman creation**: plants, animals, rocks, and so on.

William Newell: The word translated “*revealing*” is *apokalupsis*, a removal of a covering,—as when some wonderful statue has been completed and a veil thrown over it, people assemble for the “*unveiling*” of this work of art. It will be as when sky rockets are sent up on a festival night: rockets which, covered with brown paper, seem quite common and unattractive, but up they are sent into the air and then they are revealed in all colors of beauty, and the multitude waiting below shout in admiration. Now the saints are wrapped up in the common brown paper of flesh, looking outwardly like other folks. But the whole creation is waiting for their unveiling at Christ’s coming, for they are connected with Christ, one with Him, and are to be glorified with Him at His coming. (*Romans 8: Expository Notes Verse by Verse*)

B. (:20-21) Appointment from Futility to Freedom

1. Decree of Present Futility

*“For the creation was subjected to futility,
not of its own will, but because of Him who subjected it,”*

John Toews: The created order awaits redemption so eagerly because creation is caught up in humanity’s futility. “*Futility*,” used elsewhere only in **1:21**, refers to something that does not function according to design. Creation was drawn into the consequences of Adam’s sin against its will (lit., “*not willingly*”). Creation was subjected, or more literally “*ordered under*” (the verb is used twice in v. 20 for emphasis), by God to the conditions of Adam’s fall. The result is that creation is **enslaved**, which is further defined as the decay of mortality. Paul is interpreting **Genesis 3**, and together with Judaism holds to the intimate unity of humanity and creation.

2. Decree of Future Freedom

*“in hope that the creation itself also will be set free from its slavery to corruption
into the freedom of the glory of the children of God.”*

John Toews: The end-time appearance of the family of God is the decisive event that creation awaits. It will reverse the rebellion of humanity against God and the loss of the glory of God (**ch. 1**).

Spurgeon: Everything here is blighted, and subject to storm, or to decay, or to sudden death, or to calamity of some sort. It is a fair world, but there is the shadow of the curse over it all. The slime of the serpent is on all our Edens now.

Michael Bird: I know of no other verse in all of Scripture that better describes the majestic vision of Christian hope. The shackles of slavery replaced with freedom. The darkness of destitution driven away by rays of divine glory.

Michael Gorman: The earth, indeed the entire cosmos, and humanity were created to be partners. Despite whatever present issues exist, they will one day be co-participants in God's glorious future.

Grant Osborne: Translating Paul's complex thought here into English is not easy. Paraphrasing has been the most helpful. For example, **Phillips** has, "*The world of creation cannot as yet see reality, not because it chooses to be blind, but because in God's purpose it has been so limited—yet it has been given hope. And the hope is that in the end the whole of created life will be rescued from the tyranny of change and decay, and have it share in that magnificent liberty which can only belong to the children of God!*"

Martin Lloyd-Jones: I wonder whether the phenomenon of the Spring supplies us with a part answer. Nature every year, as it were, makes an effort to renew itself, to produce something permanent; it has come out of the death and the darkness of all that is so true of the Winter. In the Spring it seems to be trying to produce a perfect creation, to be going through some kind of birth-pangs year by year. But unfortunately it does not succeed, for Spring leads only to Summer, whereas Summer leads to Autumn, and Autumn to Winter. Poor old nature tries every year to defeat the "vanity" of the principle of death and decay and disintegration that is in it. But it cannot do so. It fails every time. It still goes on trying, as if it feels things should be different and better; but it never succeeds. So it goes on "*groaning and travailing in pain together until now.*" It has been doing so for a very long time... but nature still repeats the effort annually. But, it will be set free one day from this corruption "*into the freedom of the glory of the children of God.*"

C. (:22) Agitated Anguish

"For we know that the whole creation groans and suffers the pains of childbirth together until now."

Our dying world shows its desperate need to be delivered.

III. (:23-25) FRACTURED BELIEVERS LONG FOR THE REDEMPTION OF THE BODY

A. (:23) Entrapment in Suffering Bodies Causes Groaning for Redemption

"And not only this, but also we ourselves, having the first fruits of the Spirit, even we ourselves groan within ourselves, waiting eagerly for our adoption as sons, the redemption of our body."

John Toews: Two decisive moments characterize the redemption of followers of Jesus. The first

is the **reception of the Spirit**. Paul returns to the definition of the Christian as one who has the Spirit (v. 9). The reception is a first fruits event. The image comes from the Jewish practice of bringing a “*first fruits*” of the grain harvest as offering to the Temple. The offering is the beginning of the full harvest, and the guarantee that the whole process will be completed. The harvest toward which the first fruits of the Spirit point is the **resurrection of the body**, the second decisive moment of redemption. The Spirit begins a process of redemption that leads to a new embodiment. Redemption cannot be complete with the gift of the Spirit or within the present creation, it requires an “*adoption*” to a new family in a new created order. Creation looks for the revelation of the children of God; believers look for their own adoption as God’s children, which is defined as the redemption of the body. The current status of family relations is incomplete; it requires a new creation.

The time between the two moments of receiving the Spirit and the resurrection of the body is a time of **groaning**. Christians, because of the Spirit, groan in longing for complete redemption. Spirit possession does not distance Christians from creation, but rather intensifies the **solidarity with creation both in suffering and in hope for full salvation**.

Michael Bird: The **groaning for glory** aches after two things: “*adoption to sonship*” and “*redemption of our bodies*.” Paul has already referred to adoption and redemption as present experiences of believers (see **3:24; 8:15**). However, the whole gamut of Paul’s theology is pervaded by the now and the not-yet, and so it is with adoption and redemption. While Christians have already received adoption and been redeemed, these facets of salvation still await a final consummation. In the case of adoption, what awaits is the final revelation of sonship in glory. In the case of redemption, it is not just redemption from the penalty of sin, but the redemption of the body from the presence of sin that remains outstanding. The resurrection of the body will be the event that will consummate both adoption and redemption.

R. Kent Hughes: We also groan because of the misery of living in our fallen bodies in this fallen world. **Ray Stedman** writes:

Our lives consist of groans. We groan because of the ravages that sin makes in our lives, and in the lives of those we love. Also we groan because we see possibilities that are not being captured and employed. And then we groan because we see gifted people who are wasting their lives, and we would love to see something else happening. It is recorded that, as he drew near the tomb of Lazarus, Jesus groaned in his spirit because he was so burdened by the ravages that sin had made in a believing family. He groaned, even though he knew he would soon raise Lazarus from the dead. So we groan in our spirits—we groan in disappointment, in bereavement, in sorrow. We groan physically in our pain and our limitation. Life consists of a great deal of groaning.

Douglas Moo: Many interpreters take the phrase “*who have the firstfruits of the Spirit*” **concessively**: *We groan despite the fact that we have the Spirit*. But it makes better sense to give it a **causal interpretation**: *We groan because we have the Spirit*. Once the Spirit, with his demand for holiness, enters our lives, we sense as never before just what God wants us to be. As a result, the Spirit increases our frustration at not meeting God’s standard and our yearning to be what he wants us to be. What do we wait for? “*The redemption of the body*” refers to the rescue

of the body from sin and death that will happen when it is raised from the dead (see **8:10–11**).

B. (:24-25) Essence of Hope Requires Perseverance

*“For in hope we have been saved, but hope that is seen is not hope;
for why does one also hope for what he sees?
But if we hope for what we do not see, with perseverance we wait eagerly for it.”*

With hope and patience we also yearn for our full deliverance.

Michael Bird: Paul characterizes the intervening period as a time not only for groaning, but also of **hope**. Believers are “saved” with a “hope” for their adoption and redemption to be finalized. Hope, however, assumes that one does not possess what one currently awaits. Precisely because it is a hope in “*what we do not yet have*,” one must “*wait for it patiently*.” Christian hope looks forward, not vainly, but with **confidence** in God’s promise, that they will inherit the world (see **Rom 4:13**).

Douglas Moo: Nevertheless, Paul assures us, this hope is not of the normal human kind—“I hope I win the lottery.” No, Christian hope is solidly founded in God himself. Thus, we can “*wait for it patiently [hypomones]*” or, perhaps better, “*with endurance*.” This word suggests the ability to bear up under the trials that come our way (cf. **Rom. 5:3–4; Heb. 10:36; 12:1; James 1:3–4; 5:11**). “*Wait for*,” the same word Paul used of creation in **Romans 8:19**, connotes a person craning his or her neck to spot someone or something coming. In the next few verses (**8:26–30**), Paul will explain why believers can look so eagerly and hopefully for what is coming.

Grant Osborne: Waiting for things *patiently* is a quality that must be developed in us (see **Romans 5:3-4; James 1:3-4; 5:11; Revelation 13:10; 14:12**). Patience is one of the Spirit’s fruits borne in our lives. It includes fortitude, endurance, and the ability to bear up under pressure in order to attain a desired goal.

DEVOTIONAL QUESTIONS:

- 1) How does this passage help address the age-old question of how a good God can allow suffering in this world?
- 2) What should be the Christian’s perspective towards our physical body?
- 3) How can we embrace present suffering while staying focused on future glory?
- 4) How can we develop our vision of our future glory to help fortify us in the midst of present groaning?

QUOTES FOR REFLECTION:

Michael Gorman: Paul characterizes the present age of suffering as creation's "labor pains" (8:22; cf. **Mark 13:8**), during which creation (8:19–22), the faithful (8:23–25), and even the Spirit of God (8:26–27) groan, even as suffering shapes believers into the image of Christ (8:28–30). Apocalyptic writers often used the imagery of labor pains—intense suffering just before intense joy—to indicate the run-up to the prophetically promised new creation (e.g., **Isa 65:17–22**). Paul is such a writer, but his views are shaped by his belief in a crucified and resurrected Messiah.

R. Kent Hughes: He begins **verse 18** by saying, "*I consider,*" meaning "I have thought it over carefully—I have weighed the evidence and thus reckon it to be so." He says essentially the same thing in **2 Corinthians 4:17**—"*For this light momentary affliction is preparing for us an eternal weight of glory beyond all comparison.*" No matter what we have gone through, are presently going through, or will go through, the sum total is not worth comparing with the glory that awaits us. We can compare a thimble of water with the sea, but we cannot compare our sufferings with the coming glory.

What, then, must this glory be like? We know that the universe will be transformed (cf. **Revelation 21:1**). We also know that we will have bodies like Christ's glorified body (cf. **Philippians 3:21**). These are thrilling truths, especially when we reflect on how marvelous our own bodies are even now! When **C. S. Lewis** preached the sermon "*The Weight of Glory*" in the Church of St. Mary the Virgin, Oxford on June 8, 1941, he gave as eloquent an explanation as has ever been given. In his homily he noted that the promises of Scripture may be reduced to five headings:

- 1) we shall be with Christ,
- 2) we shall be like him,
- 3) we shall have "glory,"
- 4) we shall be feasted, and
- 5) we shall have some official position in the universe.

In speculating on what our glorification may involve, Lewis noted that the Scriptures indicate that as part of our glory we will shine like the sun (**Matthew 13:43**). He concluded:

Some day, God willing, we shall get in. When human souls have become as perfect in voluntary obedience as the inanimate creation is in its lifeless obedience, then they will put on its glory, or rather that greater glory of which Nature is only the first sketch. For you must not think that I am putting forward any heathen fancy of being absorbed into Nature. Nature is mortal; we shall outlive her. When all the suns and nebulae have passed away, each one of you will still be alive. Nature is only the image, the symbol; but it is the symbol Scripture invites me to use. We are summoned to pass in through Nature, beyond her, into that splendour which she fitfully reflects.

This hope was as real to Paul as meat and drink. **Lewis** was right when he said:

*Indeed, if we consider the unblushing promises of reward and the staggering nature of the rewards promised in the Gospels, it would seem that our Lord finds our desires not too strong, but too weak. We are half-hearted creatures fooling about with drink and sex and ambition when **infinite joy** is offered us, like an ignorant child who wants to go on making mud pies in a slum because he cannot imagine what is meant by the offer of a holiday at the sea.*

Belief in what the Scriptures say will change our lives. Some of us need to have our eyes lifted from the dirt toward the heavens. There is simply no comparison of our pleasure or pain with the glory yet to be revealed.

As we continue on with our study of **verses 18–27**, Paul presents the hope as so substantive that creation groans for it, believers groan for it, and even the Holy Spirit aids believers with his own groans. Christian hope that eventuates in groans is a marvelous asset to living.

Steven Cole: Present Suffering, Future Glory

Some become agnostics or atheists because they cannot come up with satisfactory answers to the question of how a loving, all-powerful God can allow the **terrible suffering** that is in the world. Since none of us are exempt from suffering and death, it's important that we understand what the Bible teaches on this difficult topic. . .

To persevere in present sufferings with hope, keep your eyes on the future glory that God has promised us.

In our text, Paul wants us to understand two certainties and a practical conclusion that flows from them: First, the present time is marked by sufferings because of man's fall into sin. Second, the future will be marked by glory for believers as God fulfills all His promises to us. The practical conclusion is, if we keep our eyes on the future promised glory, then we can endure present sufferings with perseverance and hope. . .

Pastor John Piper ("*Subjected to Futility in Hope*," part 1, on DesiringGod.org) points out that if you think that somehow the suffering in this world is out of proportion to what is deserved, then you do not grasp the infinite holiness of God or the unspeakable outrage of sin against this holy God. God's judgment on the entire creation as seen in all of history's horrible tragedies reveals how horrific our sin is to Him. Piper adds, "But in fact the point of our miseries, our futility, our corruption, our groaning is to teach us the horror of sin. And the preciousness of redemption and hope." Thank God, He sent the Savior!

But the fact of terrible suffering does not undermine the fact that God has a plan and that He will accomplish His plan. Paul says that the creation was subjected to futility "*in hope*" (**8:20**). He also uses the analogy of birth pains (**8:22**). The outcome of birth pains is the hope of new life. And even so, God is moving history toward a goal that includes our future glory. . .

Conclusion

If you've ever watched your favorite team play in the Super Bowl, you were anxious as the game progressed, especially if it was close. If your team fumbled or threw an interception, you groaned

because you didn't know the outcome. You hoped they would win, but your hope was uncertain. Maybe you even got depressed when they were far behind.

But if your team came from behind and won in the last seconds of the game and later you watched a replay of the game, your whole attitude was different. You didn't despair when they fumbled or fell behind, because you knew how it all would turn out. Knowing the certainty of the future glory gave you hope to persevere through the setbacks.

If we become anxious or depressed in trials and lose hope, it's because we've forgotten the **absolutely certain outcome**: Future glory forever with Christ! Yes, there is present suffering because we live in a fallen world. But God has promised future glory. Keeping that in view will enable you to persevere any suffering with hope.

Bruce Hurt: The abrasive experiences we encounter each day help to prepare us for heaven. The sovereign God uses all of life's troubles to polish and perfect our character. If we accept our trials with the right attitude (cp **1Th 5:18-note**) and recognize that the heavenly Father is working through them (cp **Jas 1:2-note, Jas 1:3, 4-note**), we will someday shine with splendor before Him (cp **Da 12:3, Pr 4:18, Mt 13:43**).

In the rough, a diamond looks like a common pebble, but after it is cut, its hidden beauty begins to emerge. The stone then undergoes a finishing process to bring out its full radiance. A skilled craftsman holds the gem against the surface of a large grinding wheel. No other substance is hard enough to polish the stone, so the wheel is covered with diamond dust. This process may take a long time, depending on the quality desired by the one who will buy it.

This is similar to the way God works with us. The procedure is not pleasant, nor is it intended to be. The Divine Workman, however, has our final glory in view (**2Cor 4:16, 17, 18**). We may be "*grieved by various trials*," as Peter said, but when we understand what is behind them we can rejoice even in adversity (**1Pe 1:6-note**). God has one goal in mind during the refining process: that our faith "*may be found to praise, honor, and glory at the revelation of Jesus Christ*." (**1Pe 1:7-note, Ps 66:10-note**) Knowing this enables us to look beyond the unpleasantness of "polishing" to see the outcome (**Ro 8:29-note**). **P. R. Van Gorder**. (Our Daily Bread, Copyright RBC Ministries, Grand Rapids, MI. Reprinted by permission. All rights reserved)

**A gem cannot be polished without friction,
nor a man perfected without adversity.**

Charles Simeon: Who can conceive the blessedness of that state to which we are hastening? If "*eye hath not seen, nor ear heard, nor heart conceived the things which are enjoyed by God's people in this present world*," how much less can any just conception be formed of their future state? If the possession of the first-fruits be so glorious, what must the harvest be! If the privilege of being God's children be so delightful now, that the very hope of it raises us above all the joys or sorrows of this present world, what shall the full manifestation of it be when all the interests of time and sense are forever passed away? Let us then survey more and more the blessedness of heaven, where we shall behold face to face that Saviour who died for us, and be with him for ever, possessing, according to their capacity, all the fulness of his beauty, his felicity, and his

glory. Dear brethren, let this prospect swallow up every inferior consideration, and animate us to run with ever increasing diligence the race that is set before us. Let us “forget all that is behind, and reach forward to that which is before, and press on with all imaginable ardour for the prize of our high calling in Christ Jesus.”

Leedy Greek NT Diagrams:

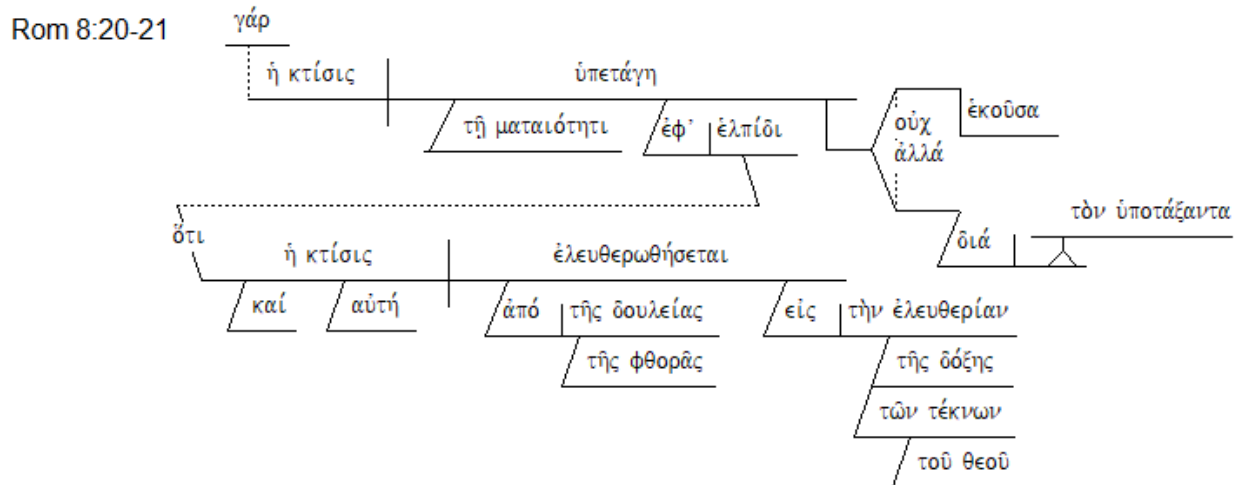
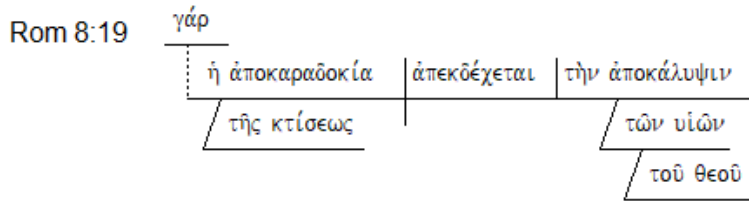
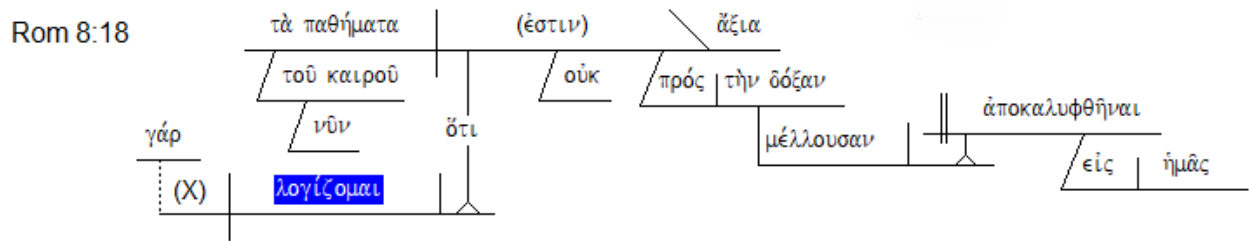

Rom 8:22-23

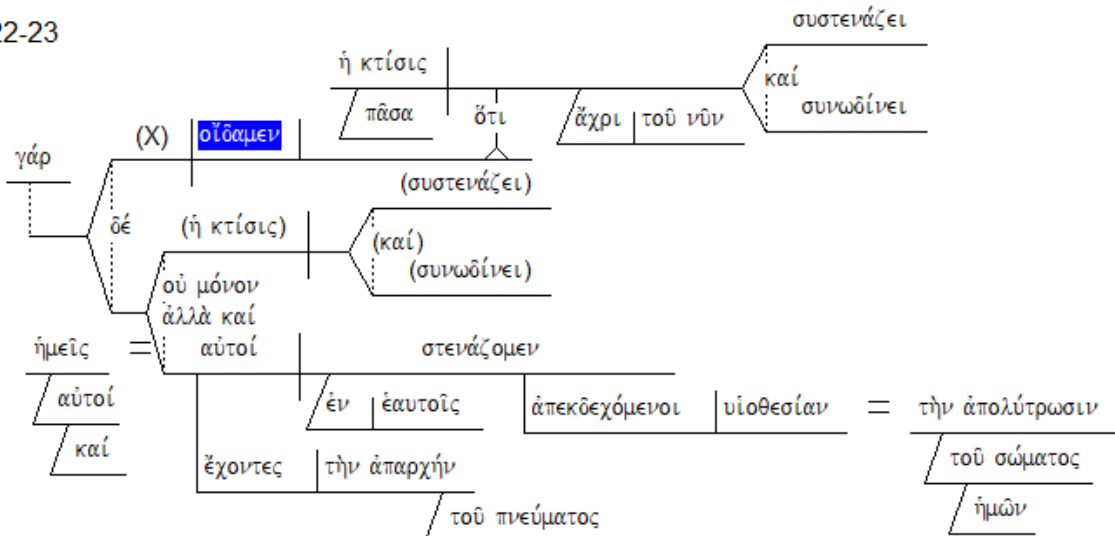

Rom 8:24

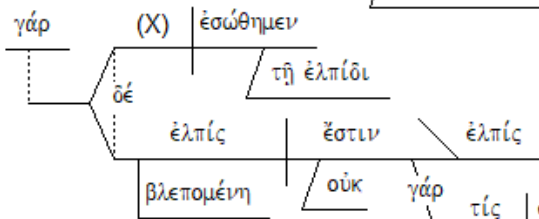

Rom 8:25

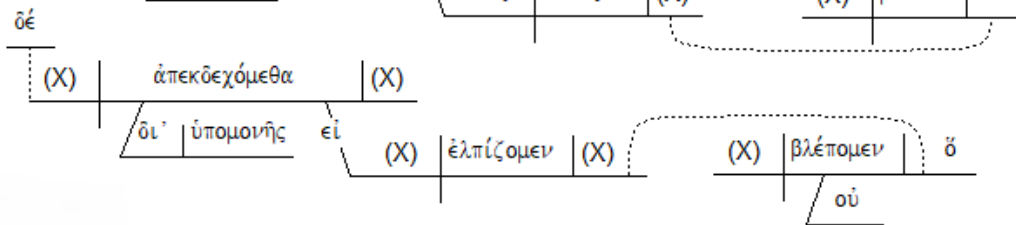

Frank Thielman:

18a	Explanation (of 17b–c)	For I reckon that the sufferings of the present time are not worth weighing against
b	Comparison (to 18a)	the glory about to be revealed in us.
19	Basis (of 18)	For the eager expectation of creation awaits the revelation of the sons of God.
20a	Basis (of 19)	For the creation was subjected to futility,
b		not willingly, but
c	Contrast (to 20b)	because of the One who subjected it,
d	Sphere	in hope
21a	Basis (of 20d)	because the creation also will be ↺ set free
b		from slavery to decay
c		for the freedom of the glory of the children of God.
22a	Explanation (of 21b)	For we know that the whole creation groans and suffers birth pangs
b		in all its parts
c		up to the present time.
23a	Comparison (to 22a)	And not only so, but we too ... we ourselves also groan,
b	Concession	although we have the firstfruit of the Spirit,
c	Simultaneous	while we await adoption as sons,
d	Identification (of 23b)	the deliverance of our ↺ bodies.
24a	Basis (for 23c)	For we were saved in hope.
b		Now hope that is seen is not hope,
c	Basis (for 24b)	for who hopes for what he or she sees?
25a	Contrast (to 24c)	But if we do not see what we hope for,
b		we wait for it with endurance.

TEXT: ROMANS 8:26-27

TITLE: THE HOLY SPIRIT INTERCEDES FOR US

BIG IDEA:

THE COMPASSIONATE INTERCESSION OF THE HOLY SPIRIT HELPS KEEP US ON TRACK AS WE ENDURE THE SUFFERINGS OF THIS LIFE ON OUR WAY TO GLORY

INTRODUCTION:

Thomas Schreiner: The idea of the Spirit groaning is not the main idea of **verses 26–27**. What Paul stresses is the **Spirit’s aid in our weakness**, and the groaning of the Spirit is not the thematic center, since it is relayed in a dative phrase near the end of **verse 26**. In addition, the groaning of creation and believers is not the main point of **verses 19–22** and **23–25**. In both instances the focus is on the **eschatological hope** that anticipates the indescribable beauty of future glory. The theme that joins this text with the preceding, then, is that **the Spirit sustains our hope while believers await redemption** (Murray 1959: 310–11; D. Moo 1991: 559–60).

Believers, then, should take tremendous encouragement that the **will of God** is being fulfilled in their lives despite their weakness and inability to know what to pray for. God’s will is not frustrated because of the weakness of believers. It is fulfilled because the Spirit intercedes for us and invariably receives affirmative answers to his pleas. We can see how nicely this fits with the next verses, where Paul teaches that God works everything together for good and that God has designed all things so that we are conformed to the image of his Son. No wonder all things are working out for our good: **the Spirit is effectively praying for us** so that the will of God will be accomplished in our lives, and we know that God identifies with and cares about our experiences of suffering, which provides comfort.

Douglas Moo: These groanings of the Spirit are perfectly in accord with God’s will (**v. 27**). Thus God, who knows the heart, hears and answers those prayers. Our inability to pray as precisely as we would like is no hindrance to the working out of God’s perfect will in our lives. We may not know what to ask for in a given situation, but the Spirit does. His requests are in perfect harmony with the will of the Lord for us. As Jesus intercedes for us before the Father (cf. **8:34**), guaranteeing our salvation, so the Spirit intercedes for us in our hearts, preparing us for that salvation.

R. Kent Hughes: How marvelous this all is! We have two intercessors:

- one in Heaven—our Lord Jesus who intercedes for our sins (**v. 34**) and
- one in our hearts—the Holy Spirit himself. How greatly we are loved!

Grant Osborne: As believers, we are not left to our own resources to cope with problems. Even when we don’t know the right words to pray, the Holy Spirit prays with and for us, and God answers. With God helping us to pray, we don’t need to be afraid to come before him. We simply ask the Holy Spirit to intercede for us “*in accordance with God’s will.*” Then, when we

bring our requests to God, we will trust that he will always do what is best.

Thomas Constable: The basic principle of effective praying is that it must be in harmony with the will of God to be effective (**1 John 5:14-15; John 14:13; 15:16; 16:23-24**). However, what the precise will of God is is often hard for us to know. The Holy Spirit then comes to our aid: "*the Spirit Himself intercedes for us.*" To intercede means to pray for someone else.

I. (:26a) THE HOLY SPIRIT HELPS US RIGHT NOW IN OUR WEAKNESS IN PRAYER IN THE CONTEXT OF SUFFERING

"And in the same way the Spirit also helps our weakness;"

- Our weakness and suffering is very real and very painful
- Our best resource in this life is the person of the Holy Spirit
- The Holy Spirit is our Helper

Thomas Schreiner: The hope of believers is also strengthened by the assistance of the Holy Spirit. The verb συναντιλαμβάνεται (*synantilambanetai, helps*) is probably intensive, indicating not merely that the Spirit joins in helping but also that the Spirit himself and alone renders the assistance believers need. The text says the Spirit helps believers "*in our weakness*" (τῇ ἀσθενείᾳ ἡμῶν, *tē astheneia hēmōn*). The weakness that believers experience is doubtless due to their general incapability, and thus the term could designate weakness in a broad and undefined way (**Murray** 1959: 311; **Dunn** 1988a: 477; **Fee** 1994: 578); for instance, in the near context Paul speaks of the weakness of waiting for future redemption (**Wright** 2002: 598). Still the γάρ (*gar, for*) in the text suggests that the weakness is more specific. Indeed, **O'Brien** (1987: 69) is probably correct in detecting a chiasm in this verse in which the second part defines more precisely the first element (cf. also **Sanday** and **Headlam** 1902: 213).

A The Spirit helps
B in our weakness.
B' For we do not know what to pray for as we should
A' but the Spirit intercedes with unspeakable groanings.

In the chiasm, the weakness of believers is defined in terms of their ignorance as to what is the proper content of prayer, and the Spirit's help is defined in terms of his intercession for believers. Paul is not describing, then, the Spirit's help for us in a general way, nor does he contemplate weakness as a total phenomenon in the lives of believers. It is **weakness in prayer** that Paul zeros in on, and the **Spirit's help in prayer** is the answer to our weakness.

Steven Cole: The word "*helps*" occurs only here and in one other place in the New Testament. The meaning is, someone is carrying a heavy load and another person comes alongside to take the other end and bear the burden with him. The other use of "*help*" is in **Luke 10:40**, where Jesus is in the home of Mary and Martha. Mary was sitting at Jesus' feet, but Martha was distracted with all her preparations. Finally, she burst out, "*Lord, do You not care that my sister has left me to do all the serving alone? Then tell her to help me.*" She wanted her sister to help bear the burden of preparing and serving the meal.

The word implies that the Holy Spirit doesn't do everything, while we sit back and do nothing. Rather, we are to keep praying and, if appropriate, keep working or obeying or whatever the Bible may tell us to do about our situation. But as we pray, the Spirit says, "Let Me grab the other end. Let me help you by picking up your burden and taking it before the Father's throne. I know what to pray for when you don't." So the Spirit helps us by praying for us in our weakness. What an encouragement!

II. (:26b) THE HOLY SPIRIT INTERCEDES FOR US

A. Our Weakness in Prayer

"for we do not know how to pray as we should,"

(contrast between our helplessness and confusion vs. compassionate intercession of the Holy Spirit)

Thomas Schreiner: Most scholars now agree that the weakness of believers lies in the "content" of prayers. They do not know adequately what to pray for. . . The weakness of believers in prayer, therefore, is that they do not have an adequate grasp of what God's will is when they pray. Because of our finiteness and fallibility, we cannot fully perceive what God would desire.

John Murray: Prayer covers every aspect of our need, and our weakness is exemplified and laid bare by the fact that we know not what to pray for as is meet and proper. It is not our ignorance of the right manner of prayer that is reflected on, as the rendering of the version might suggest. It is rather our ignorance respecting the proper content – we know not what to pray as the exigencies of our situations demand. It is at the point of this destitution on our part that the Holy Spirit comes to our help, and upon this particular aspect of the Spirit's activity the apostle concentrates attention as peculiarly and by way of eminence the grace of the Spirit in reference to our infirmity, the grace which consists in the fact that he "*himself maketh intercession for us with groanings which cannot be uttered.*"

B. The Holy Spirit's Strength in Prayer

"but the Spirit Himself intercedes for us with groanings too deep for words;"

Thomas Schreiner: The term ἀλάλητος could mean that which cannot be uttered in words, but it much more likely means "*without speech,*" the absence of any vocalization at all. This seems to be the most natural way of translating a word that negates a word for speech. . . The most serious objection to a reference involving speaking in a tongue is that **Rom. 8:26–27** refers to all Christians, while glossolalia is reserved for only a few. . .

God searches the hearts of believers and finds unutterable longings to conform their lives to the will of God. The Holy Spirit takes these groanings and presents them before God in an articulate form. Even though believers cannot specify their requests to God adequately since they don't know his will sufficiently, the Holy Spirit translates these groanings and conforms them to God's will.

John Murray: the groanings are not expressed in articulate speech; they are not request or petitions or supplications which are formulated in intelligible utterance. While far from being devoid of content, meaning, and intent, they nevertheless transcend articulated formulation. The groanings will have to be understood as the groanings which are registered in the hearts of the children of God.

Frank Thielman: The term “wordless” (ἀλαλήτοις) does not refer to glossolalia (cf. **1 Cor 13:1; 14:9**) or to the “inexpressible things” of paradise “that no one is permitted to tell” (2 Cor 12:4 NIV). It simply emphasizes the inarticulate nature of the groans that characterize existence within a world subjected to futility (**8:20**). The Spirit enters into this existence in order to help believers and requests God’s aid for believers in their plight.

Steven Cole: I suggest that Paul pictures the Holy Spirit groaning on our behalf to convey that He takes up our needs at the deepest emotional level and conveys our hurts and cares to the Father’s throne, all in line with the will of God. This should encourage us to pour out our hearts before Him (**Ps. 62:8**).

III. (:27) THE HOLY SPIRIT ASKS FOR THE EXACT THINGS WE NEED IIN HARMONY WITH GOD THE FATHER

A. God the Father Intimately Knows God the Spirit

“and He who searches the hearts knows what the mind of the Spirit is,”

Frank Thielman: The Spirit is able to intercede effectively for believers because he not only knows what believers need in their distress but also because he knows, and is fully known by, God.

B. God the Spirit Intimately Knows God the Father

“because He intercedes for the saints according to the will of God.”

The Harmony between God the Father and God the Holy Spirit
(between the mind of God and the mind of the Spirit;
between the will of God and the will of the Spirit;
between the love of God and the love of the Spirit for us;
between the desire of both to see Christ glorified in us)
ensures that His Compassionate Intercession will keep us on track
(since His help is totally consistent with the will of God)

David Thompson: Now **verse 27** is a critical verse pertaining to the subject of the will of God. This verse clearly implies that there is a specific will of God for your life as a believer and the Holy Spirit, working in harmony with the other members of the Godhead, is involved in interceding concerning that will especially when we are suffering.

There is obviously a sovereign will of God that sometimes is hidden from our knowledge and the Holy Spirit knows exactly what that will is and He prays on our behalf, knowing that will.

* * * * *

DEVOTIONAL QUESTIONS:

- 1) Why do we find it so difficult to pray when we have so much encouragement from Scripture?
- 2) What encouragement do you take from knowing that both God the Son and God the Spirit are interceding on your behalf before God the Father?
- 3) Do we have unrealistic expectations that we should always be able to understand and articulate God's divine will for our life?
- 4) Why can't this text be a reference to praying in tongues?

* * * * *

QUOTES FOR REFLECTION:

Michael Bird: God is the one who searches and knows the human heart (see, e.g., **1 Chr 28:9; Pss 44:21; 139:23; Jer 17:10; Acts 15:8; Rom 2:16; 1 Cor 14:25**), and it is God who knows the Spirit because he is the Spirit of God (not to mention that "*the Lord is the Spirit*," see **2 Cor 3:17-18**). Because of the **unity** between God and the Spirit in one mind and will, the Spirit is effective when he intercedes for the saints. **Wright** has a good take on this: "This hints at something deeper than merely prayer in the way that God wants or approves; God's own life, love and energy are involved in the process. The Christian, precisely at the point of weakness and uncertainty, of inability and struggle, becomes the place at which the triune God is revealed in person."

John Toews: The situation of the Christian between the ages is one of **weakness**. The weakness is defined as a **problem of prayer**, specifically **not knowing what to pray**. The not praying as we ought in **v. 26** is further explained as according to God's ordering or will in **v. 27**. On the one hand, Christians pray *Abba, Father*, but, on the other hand, their ability to pray is seriously limited by inadequate knowledge about God's design for what is intended.

The good news is that God's Spirit shoulders the weakness (lit., "*lends a hand*"). The Spirit is pictured as present and assisting believers in the depths of human crisis, their inability to communicate with the intimate *Abba, Father*. The Spirit intercedes with wordless groans, without the speech which distinguishes humans from animals in the ancient world. The image pictures "depth" communication, which is **below ordinary human consciousness**. Such communication is possible, Paul assures his readers, because God is the Searcher of the human heart, an intriguing picture of God from biblical and Jewish tradition (**1 Sam. 16:7; 1 Kings 8:39; Pss. 7:9; 17:3; 26:2; 44:21; 139:1-2, 23; Jer. 17:10; Wis. 1:6; Sir. 42:18; Bib. Ant.**

50:4). God alone knows the deep center of people. God knows the mind of the Spirit, a repeat of the phrase from v. 6 where it stands over against mind of the flesh and gives life and peace.

Paul reverses the normal understanding of the Spirit as the one who searches everything, even the depths of God (**1 Cor. 2:10-11**). The Spirit, present in the depth of human creatureliness, here is known to God and does what Christians cannot do for themselves, intercedes for them according to the will of God. In **8:34** Paul pictures Christ as interceding at the right hand of God. The idea of humans needing intercession before the throne of God, either by angels or distinguished leaders (e.g., patriarchs, prophets), was common in Judaism (**Job 33:23-26; Tob. 12:15; 1 En. 9:3; 15:2; 99:3; 104:1; T Levi 3:5-6; 5:6; T Dan. 6:2**). What is remarkable here is that it is the eschatological Spirit and the risen Christ who do the interceding. The ongoing crisis of faith, or the depth of Christian groaning together with the created order, could hardly be pictured more graphically. Believers have the status of being children in a new intimate family relationship with God, but they are **not able to communicate properly with God**. The experience of contradiction living between the ages is profound. Christians are **totally dependent on the help of the Spirit and Christ**.

Steven Cole: So while there are difficult details in these verses, the bottom line is pretty clear: **We should be encouraged to pray**. We won't fully understand the mystery of prayer in this life, but we know that the Lord commands us to pray. He has ordained prayer as the means through which we cooperate with Him in bringing about His sovereign will. He encourages us with the truth that the Holy Spirit, who dwells in us, tenderly takes our prayers and directs them according to God's will before His throne. Here are three final applications:

- *Don't let the fact that you don't know how to pray as you should discourage you from praying.* Paul didn't know how to pray as he should, but he told us to "*pray at all times in the Spirit*" (**Eph. 6:18**). So keep at it even when you don't understand it.
- *Don't let the fact that prayer isn't easy discourage you from praying.* Paul told the Colossians (**4:12**) that Epaphras was "*always laboring earnestly for [them] in his prayers.*" Prayer is often hard work. It isn't easy. But keep working at it. Finally,
- *Don't let the fact that your prayers don't seem to be answered keep you from praying.* Make sure that to the best of your understanding you are praying in accord with God's will. But if you are praying unknowingly for something that is not His will, you can trust that the Spirit will take your prayers and line them up with God's perfect will. This gracious truth, that the Holy Spirit tenderly prays for us in our weakness, should cause us to persevere in prayer, especially in times of trial.

Leedy Greek NT Diagrams:

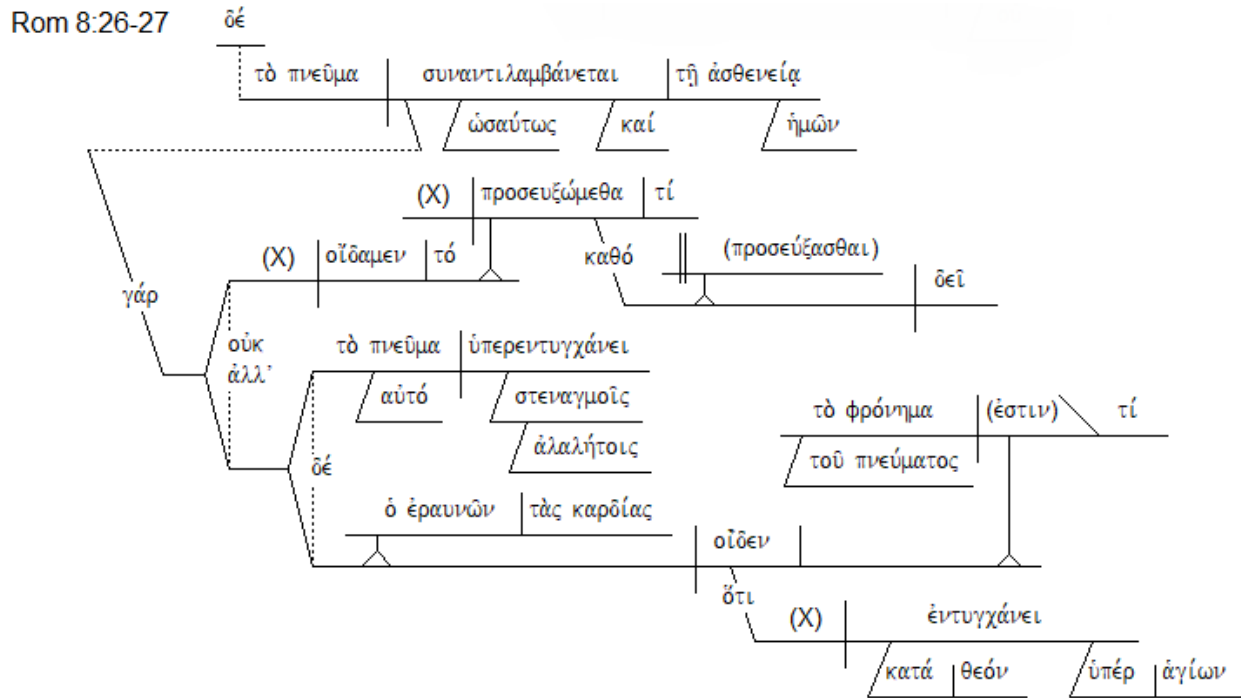

Frank Thielman:

- 26a Comparison (to 24b) And likewise also, **the Spirit helps our weakness;**
 b Basis (for 26a) for **we do not know**
 c Content what it is necessary to pray,
- d Contrast (with 26b) but **the Spirit himself intercedes**
 e Instrument with wordless groans.
- 27a Explanation (of 26) And **the one who searches hearts knows**
 b Content what the mindset of the Spirit is
 c Basis (for 27a) because he intercedes on behalf of the saints ☞
 according to God's will.

TEXT: ROMANS 8:28-30

TITLE: THE UNBREAKABLE CHAIN OF SALVATION PROVES GOD'S DESIGN FOR OUR ULTIMATE GOOD

BIG IDEA:

GOD'S UNBREAKABLE CHAIN OF SALVATION PROVIDES ETERNAL SECURITY AND THE ASSURANCE THAT GOD IS WORKING ALL THINGS TOGETHER FOR OUR GOOD

INTRODUCTION:

Steven Cole: The security of our salvation (or the final perseverance of the saints) flows out of Paul's overall doctrine of salvation. Paul is showing that our salvation from start to finish is from the Lord and so it can never fail:

Our salvation is secure because God originated it, He effected it, and He will complete it.

These verses reveal our past, present, and future. Before the foundation of the world, God planned our salvation: He foreknew and predestined us to salvation. As a result of these sovereign decisions, at some point in our lives, He effectually called us and justified us, so that now He is working to conform us to the image of His Son. In the future, we will be glorified, fully conformed to Christ, who will be preeminent over all. The entire process comes from God and is sustained by Him. It's all designed for His glory. If His sovereign purpose for the glory and supremacy of Jesus Christ is certain, then our future glory with Christ is certain.

John Toews: The agony of groaning—for creation, Christians, and the Spirit—is answered with the assurance of glorification. The shape of the glory is described in three different forms: the revelation of the children of God for creation, the redemption of the body for Christians, and the conformity of Christians to the image of the Son for the Spirit.

Suffering is part of the cosmic reality. Christians participate in that suffering. Here it is a function of growth, growth toward God's glorification. It is part of the transformation process of being adopted as the children of God. Suffering does not lead to despair for Christians because God is working out a plan that moves through adoption as children and through suffering to **glorification**.

Michael Bird: All in all, the anchor holding steady the big five verbs in vv. 28-29 — *foreknown, foreordained, called, justified, and glorified* — is that God has always intended to create a new covenant family, a redeemed and renewed people, bearing the Spirit and imaging Christ. Believers form a forgiven family of Jews and Gentiles, groaning for glory, sustained by Spirit-inspired prayer, with creation anxiously waiting for the unveiling of the glorious freedom of these children in the age to come.

I. (:28) CONVICTION REGARDING GOD'S SOVEREIGN DEMONSTRATION OF GOODNESS TOWARDS HIS FAMILY

A. Determining Principle of God's Will

"And we know that God causes all things to work together for good"

Vance Havner: Sometimes **Romans 8:28** is not easy to accept. But Paul did not say, "We understand how all things work together for good" to the believer. He said, "We know that they do." We know many things we do not understand.

Thomas Constable: "All things" means just that: everything, "every event of life." In the context, these "things" include the misfortunes that the believer experiences. The "good" is what is good from God's perspective, and, in view of **verses 18-27**, conformity to the Son of God is particularly prominent (**v. 29**). "Those who love God" could be a group of believers who love God more than others. However, since Paul described them from the divine side as the elect of God ("those called"), they must refer to all Christians (cf. **1 John 4:19**). This is the only place in Romans where Paul wrote of the believer's love for God. Everywhere else he referred to God's love for the believer.

Grant Osborne: God works in **all things**—not just isolated incidents—for our good. This does not mean that all that happens to us is good; evil is prevalent in our fallen world. But God is able to turn it around for our long-range good. Note that God is not working to make us happy, but to fulfill his purpose. Note also that this promise can be claimed only by those who love God and are "called according to his purpose." Those who are called are those the Holy Spirit convinces and enables to receive Christ. Such people have a new perspective on life. They trust in God, not life's treasures; they look to their security in heaven, not on earth; they learn to accept, not resent, pain and persecution, because God is with them.

B. Directed towards Believers

1. Characterized by Love for God

"to those who love God,"

John Toews: The verb "to love" is used here for the first time to characterize the response of believers to God. Those who love God, usually combined with and keep his commandments, is a characteristic description of pious people in Judaism (**Deut. 7:9; Ps. 145:20; Tob. 13:12, 14; Sir. 1:10; 2:15, 16; Pss. Sol. 4:25; 10:3; 14:1; 4QpPs. 3:4-5**). Paul both identifies with this understanding and breaks with it by using only the first half. The second description is equally Jewish. God's purpose and election (calling) are two sides of the same coin. The heritage of Israel is used to characterize believers, Jewish and Gentile. Christians are people who love God and who are elected according to God's purpose.

2. Conformed to God's Eternal Purpose

"to those who are called according to His purpose."

Frank Thielman: The "purpose" here is God's (cf. **9:11; Eph 1:11; 3:11; 2 Tim 1:9**), and it is a purpose for which God's people have been "called" (cf. **Rom 1:6-7**). In **8:27** Paul had referred to God's people as "saints," and the language of calling echoes that designation (cf. **1:7; 1 Cor**

1:2). Their way of life and the goal toward which they are moving separate them from the unbelieving world around them, just as God separated Israel from the surrounding nations so that they might “*be to me a kingdom of priests and a holy nation*” (Exod 19:6).

II. (:29-30) CONFIRMATION OF GOD’S GOODNESS DEMONSTRATED IN HIS SOVEREIGN PLAN OF SALVATION FROM BEGINNING TO END

A. (:29a) Election

“For whom He foreknew,”

God has had special loving thoughts toward us from eternity past.

Thomas Constable: Paul next explained God's calling in terms of His foreknowledge and predestination. It is a mistake to conclude that God knew beforehand who would believe on His Son and then predestined those individuals for salvation. Foreknowledge is a term that specifically describes God's decision to elect: to choose to bless someone (cf. **ch. 9; 1 Pet. 1:20**). Notice that it is only those whom He foreknows that He predestines, not everyone. This indicates that a limited foreknowledge is in view, not just general knowledge of everyone and everything, which God possesses.

S. Lewis Johnson: Unconditional Election -- This is not something taught by an individual or an isolated movement. Unconditional election is taught in some of the greatest of the Christian creeds. The Westminster Confession of Faith does not say anything more or anything less than what I am saying to you right now. The thirty-nine articles of the Anglican church does not say anything more or anything less than I am saying to you right now. The canons of the Synod of Dordt do not say anything more or anything less than I am saying to you right now. The Belgic confession, the Heidelberg Catechism, these are standard confessional documents that the great mass of the orthodox have affirmed is their faith, and they have testified to it in blood. I am not alone. I am with the saints.

Furthermore, Augustine believed this. Luther believed it. Calvin believed it. Bucer believed it. Knox believed it. Beza believed it. John Owen and the Puritans. Modern theologians, Charles Hodge, William GT Shedd, Benjamin B. Warfield. Today, James Packer, John Gerstner, Roger Nicole, Harold O.J. Brown, many, many others, and among Bible teachers, Donald Grey Barnhouse, James Montgomery Boise, Dr. Barnhouse’s successor in Philadelphia, D. James Kennedy, R. C. Sproul, Manford Gutzke, Joel Nederhood of the Back to God Hour, which many of you hear, John Stott, and Dr. Lewis Sperry Chafer.

B. (:29b) Predestination

“He also predestined to become conformed to the image of His Son, that He might be the first-born among many brethren,”

God has determined a special goal for us that includes eternity future.

Michael Crawford: Being Conformed to Christ

(1) Being conformed to Christ is God’s Grand Purpose for your life.

This isn't a side issue for God. This is the issue. You were not saved to do missions. You were saved to be like Christ. Because you are like Christ you do missions. Don't lose the connection of this verse to **verse 28**. This is the "good" that God is working out all the time in your life.

(2) Being conformed to Christ is Recognizeable.

Acts 4:13 – "they recognized they had been with Jesus."

Our Christianity can become very transactional. It looks like you have been with Jesus. The way you talk, look at things, spend your money, etc.

(3) Being conformed to Christ is about Imitating Him.

1 Cor. 11:1 – You only imitate the things you love; the things you prize.

Part of our created DNA is to want to be an image bearer.

(4) Being conformed to Christ has a Why = Christ Himself.

What was the motive for Paul seeking to be conformed to Christ?

Phil. 3:7 – "that I may know Him" – Paul is obsessed with a person, not an institution. We need this type of passion for Jesus as when we were first saved.

We struggle with conformity because we don't have the Why.

Applications:

- Prayer – like a child; not sophisticated
- Endurance – just about taking the next step even if it's ugly – more concerned about looking good in our finish than finishing
- Differentiation – Jesus can be both compassionate and angry and yet without sin; you can see the truth and see the exaggerations and the minimizations; the brand of Christianity can hurt us because it conforms us to tradition

<https://mail.google.com/mail/u/0/#inbox/FMfcgzGrcFgJrwwWXxMwqOkpcGsZdcJK?project=1>

C. (:30a) Calling

"and whom He predestined, these He also called;"

God's effectual call has successfully drawn us into His wonderful eternal plan.

Steven Cole: *Called* (or *calling*) is used in two senses in the New Testament. First, the general call of the gospel goes out to all people. Jesus mentioned this when He said (**Matt. 22:14**), "Many are called, but few are chosen." He issued a general call when He said (**Mark 1:15**), "Repent and believe in the gospel." Or, when He said (**Matt. 11:28**), "Come to Me, all who are weary and heavy-laden, and I will give you rest." This general call is genuine on God's part, but it is not effectual because of the hardened hearts of the fallen human race (**John 3:19-20**). Those who refuse the gospel call will be without excuse on judgment day.

But in the New Testament epistles, *call* (or, *calling*) is always used of God's *effectual* call. It *always* accomplishes God's purpose of giving life to the spiritually dead so that they respond to the call. **Spurgeon** somewhere compares the general call to sheet lightning that lights up the

night sky, but doesn't hit anything specific. But the effectual call is like the lightning bolt that hits its target.

We see an example of God's effectual call in Jesus' calling Lazarus from the tomb. Remember, Jesus had just said (**John 11:25-26**), "*I am the resurrection and the life; he who believes in Me will live even if he dies, and everyone who lives and believes in Me will never die.*" The raising of Lazarus that followed was an unforgettable illustration of Jesus' power to call the spiritually dead to spiritual life. When Jesus called, "*Lazarus, come forth,*" He imparted life with the call, so that Lazarus responded. God's word is powerful to create new life (**John 5:24-26; James 1:18**).

Paul refers to the same truth (**2 Cor. 4:4**) when he says that Satan, "*the god of this world, has blinded the minds of the unbelieving so that they might not see the light of the gospel of the glory of Christ, who is the image of God.*" How can such spiritually blind people ever see? Paul explains (4:6), "*For God, who said, 'Light shall shine out of darkness,' is the One who has shone in our hearts to give the Light of the knowledge of the glory of God in the face of Christ.*" God's word powerfully imparts light and life to all whom He calls to salvation. His effectual call cannot fail or be thwarted by our fallen, sinful wills. As Jesus said (John 6:37), "*All that the Father gives Me will come to Me....*"

God's effectual call always comes through His general call. In other words, the gospel is preached or proclaimed to all. Some shrug it off or perhaps angrily resist it. Some, I might add, respond superficially by praying the sinner's prayer or going forward after an altar call. For a while, it looks as if they've been converted. But they're like the seed sown on the rocky ground that springs up quickly, but has no root. They may respond to the general call because they want God to help them out of a problem situation. But when suffering comes and their problems grow worse, they fall away. Or, they're like the seed sown on the thorny ground, where the worries of life or the deceitfulness of riches choke out the word so that it does not bear fruit (**Matt. 13:20-22**).

But in the elect, God's effectual call comes with power so that they are quickened from spiritual death to life. Their eyes are opened to the glory of Christ and what He did on the cross. They respond in faith and repentance. The difference between the two responses hinges on God's effectually calling those whom He predestined to salvation.

D. (:30b) Justification

"and whom He called, these He also justified;"

God has declared us worthy (righteous) even though we were not.

E. (:30c) Glorification

"and whom He justified, these He also glorified."

God tells us that our sharing in Christ's glory is certain.

Frank Thielman: Paul probably spoke of the glorification of believers as a past event to emphasize the certainty of their future glorification. The great Greek grammarian **Herbert Weir**

Smyth said that “the aorist may be substituted for the future when a future event is vividly represented as having actually occurred.” In the immediate context Paul has been focusing on the plight that believers must share with all creation since they are all caught up in the results of human rebellion against God. He has also been concerned with God’s answer to this plight through the resurrection of the dead, first of Christ and then, in the future, of believers (**8:17, 19–23**). The resurrection of believers will be the moment when they are delivered from creation’s decay and fully experience the freedom of their adoption into God’s family (**8:11, 23**).

* * * * *

DEVOTIONAL QUESTIONS:

- 1) If God is only going to ultimately save those specific individuals He has predestined, what is our motivation to pray, to witness, etc.?
- 2) How would you use these verses to counsel a believer who is struggling with their eternal security?
- 3) When we are in the midst of suffering and trials, how can we keep our focus on the ultimate good that God is accomplishing through our circumstances?
- 4) What evidence is there in your life that you are characterized as one who truly loves God?

* * * * *

QUOTES FOR REFLECTION:

Dr. Edmund Hiebert: This blessed hope—that believers will be conformed to the image of His own Son—explains God’s dealings with them as His chosen sons in this present age. He is ever at work to reproduce the moral image of Christ in them. All that now comes into their lives He uses for their good to further that glorious goal. His aim for them now is not to make them happy, materially prosperous, or famous, but to make them **Christlike**. He now uses “*all things*,” the sad as well as the glad, the painful as well as the pleasant, the things that perplex and disappoint as well as the things they eagerly strive and pray for, to further His eternal purpose for them. In His infinite wisdom He knows what is needed to bring about that transformation. For some of His own He may need to use hotter fire and strike with harder blows than in His dealings with others to effect the formation of Christ’s image in them. This may be because some believers may be more resistant to His molding activities or are more prone to insist on their own efforts.

Steven Cole: OUR SALVATION BEGAN WHEN GOD FOREKNEW US.

This is the key term to understand, since it begins the entire process. But, unfortunately, there has been a lot of misunderstanding and controversy over the meaning of the word.

Some say that it means that God knows everything in advance (which is true) and thus God foreknew who would believe in Jesus and He predestined these to salvation. Some who hold this view say that God predestined individuals based on foreseeing their faith, while others say that it's a group thing. God predestined the church as a group to salvation, but it's up to the free will of individuals to join that group. But in either case, the process is triggered not by God's sovereign choice, but rather by God's knowledge of the choices that people would make by their own free will. Thus the initiative in salvation rests with man, not with God, except that God sent Jesus to make salvation available to all.

But there are huge problems with this interpretation. First, the theology behind that view is at odds with all of Scripture, including the context here. It would mean that God made up His eternal purpose based on what sinners would choose to do, rather than on what God would do. Thus it makes man sovereign, not God. Salvation would not be according to God's call according to His purpose (**8:28**), but rather according to man's will.

But God didn't look down through history and see that Paul would choose to believe in Him, and say, "Whew! I'm so glad that Paul chose Me, because he will make a good apostle. Because he chose Me, I'll make him one of the elect." Read the story of Paul's conversion and see if that interpretation fits! It is clear that God chose to save Paul because God had a sovereign purpose for Paul's life (**Gal. 1:15**). If foreknowledge only means that God knew in advance who would believe, and thus He elected them, then He did not purpose to save a people for His glory. He just saw how the parade would go and jumped to the front of the parade. But the Bible is clear that God determined the parade route. As **Everett Harrison** puts it (Expositor's Bible Commentary, ed. by Frank Gaebelin [Zondervan], 10:98), "We are called according to purpose, not according to foreknowledge, hence foreknowledge is included in the electing purpose."

Also, the view that "*foreknowledge*" simply means that God knew in advance who would choose Him goes against what Paul said in **Romans 3:10-18**, that no one seeks for God. "*Those who are in the flesh cannot please God*" (**Rom. 8:8**), which includes faith in Christ (**Heb. 11:6**). So if it were a matter of God foreseeing what men would do, He would see that none would believe.

The Bible repeatedly shows that all of salvation, including the spiritual understanding, repentance, and faith that accompany salvation, is God's gift (**Phil. 1:29; Eph. 2:8-9; Acts 11:18; 16:14; 2 Cor. 4:4-6; 1 Cor. 2:14; 2 Tim. 2:25**, etc.). Grace is unmerited favor; if it were conditioned on our faith, it would be based on some good in us. If we could take credit for our spiritual insight or repentance or faith, we would have reason to boast over those who are not saved. So to say that "foreknow" means that God foresaw who, of their own free will, would choose to believe in Jesus, goes against the entire biblical theology of salvation.

A second reason to reject that interpretation is the biblical usage of this word. Granted, there are two times when men are the subject that the verb means "to know in advance" (**Acts 26:5; 2 Pet. 3:17**). But when God is the subject, to foreknow means to choose or determine before, often with the sense of, "enter into a relationship with before" (**Douglas Moo**, *The Epistle to the Romans* [Eerdmans], p. 532). It means that before time began, God chose to set His love on some, whom He also predestined to be conformed to the image of His Son. He isn't said here to foreknow what people will do, but rather to foreknow the people themselves.

In **Romans 11:2**, with reference to the Jews, Paul says, “*God has not rejected His people whom He foreknew.*” In **Amos 3:2** (ESV) God says to Israel, “*You only have I known of all the families of the earth.*” God obviously knows everyone, but He chose to set His love on Israel.

In **Jeremiah 1:5**, the Lord tells the prophet, “*Before I formed you in the womb I knew you, and before you were born I consecrated you; I have appointed you a prophet to the nations.*” There are many other references where the word “*know*” means to choose, especially with a view to entering into a relationship with the person (**Gen. 18:19; Deut. 7:6-8; Ps. 1:6; Jer. 1:5; Hos. 13:5; 1 Cor. 8:3; Gal. 4:9**). God knows in advance everyone who has ever lived; but some He chooses to foreknow in love. That is the meaning in **Romans 8:29**.

When God is the subject, foreknowledge has the implication of foreordaining or choosing.

Geoffrey Bromiley explains (Evangelical Dictionary of Theology [Baker], p. 420), “What [God] knows, he does not know merely as information. He is no mere spectator. What he foreknows he ordains. He wills it.” In this sense, Peter (**1 Pet. 1:20**) says of Christ, “*For He was foreknown before the foundation of the world....*” In **Acts 2:23**, Peter says of Jesus, “*This Man, delivered over by the predetermined plan and foreknowledge of God, you nailed to a cross by the hands of godless men and put Him to death.*” He doesn’t mean that God just knew in advance that Jesus, of His own free will, would offer Himself as the sacrifice for our sins. Rather, God chose and ordained Jesus for that role before the foundation of the world.

The same is true of biblical prophecy: God doesn’t just foreknow how history will happen to turn out and then report it to us. Rather, He ordains how history will turn out. If God only knows in advance how things will turn out, but He didn’t ordain it, then He would not be sovereign.

I thought it necessary to take so long on this because it is so often explained as if God just knew who would choose to believe in Christ and elected them to salvation based on their choice. But it is inconceivable that God would leave His eternal purpose of glorifying His Son through saving a people who would be conformed to His image up to the fickle choices of sinful people!

<https://bible.org/seriespage/lesson-52-why-all-things-work-together-good-us-romans-829>

Michael Bird: The evangelical faith is one that is indelibly connected to **hope in God**. That is why Paul spoke about a “*hope stored up for you in heaven and about which you have already heard in the true message of the gospel*” (**Col 1:5**), and the “*hope held out in the gospel*” (**1:23**). Because our hope is stored up in heaven does not mean we have to go to heaven in order to access it. That would be like me saying that I’ve got a beer cooling in the fridge for you and you thinking that you had to crawl into the fridge in order to drink it. Hope has come to us in the incarnation of Christ, the promise of the gospel, the gift of the Spirit, and the anticipation of life everlasting. The gospel of hope gives us assurance that what God has begun in the present he will complete in the future.

Hope is not optimism; rather, hope is the audacity of faith under adversity. Hope is the cheering in triumph for what others deem a lost cause. Hope expiates the misery of life. Hope is currency in the land of melancholy. Hope is the dancing when the music has long ceased. Hope is bread for the soul that is starved. Hope is the voice that whispers to us that “all things are possible.” Hope is the grace to face our fears, knowing that there is someone greater than the sum of all

fears. Hope holds out a light rather than curses the dark. Hope is the physician of a terrified soul. Hope is the hero of the weak. Hope is defiance in the face of the tyrant.

The gospel is the story of the invasion of hope into a world that knows only despair and doubt. The gospel tells us about men and women doomed for a hopeless end discovering in Christ Jesus an endless hope. Hope is that shameless confidence that Jesus Christ is who he said he is and that his promises to us are totally trustworthy. If so, as Käsemann puts it: “True theology ... has to remain a pilgrim theology under the message of the gospel as a promise for the whole world — a theology of hope.”

At the end of hope is the glory that is to come. Let it be noted and underlined that God’s glory has an important place in the contours of Paul’s theology, as Romans aptly illustrates. God had always intended to make the riches of his glory known to Jews and Gentiles (**Rom 9:23**). Glory is what humanity was meant to seek after and to receive from God (**2:7, 10**), yet humanity foolishly exchanged the glory of God for an inglorious idolatry (**1:23**), with the result that all humans have fallen short of God’s glory (**3:21**). Abraham was an exception as someone who gave glory to God (**4:20**), while the Israelites were the custodians of the divine glory in their worship (**9:4**). It was God’s glory that raised Jesus from the dead (**6:4**). Christ is glorified because the Gentiles have been made holy to God (**15:17**). In Jesus Christ the “*hope of glory*” is recovered (**5:2**), and it enables people to even “*glory in our sufferings*” (**5:3**). Christians suffer with Christ and will one day be glorified with Christ (**8:17**). God’s glory will be revealed in the very fabric of their being (**8:18**). Creation anxiously awaits the glorious freedom of the children of God (**8:21**). It is for this reason that Paul can burst into praise and acclaim, “*To him be the glory forever! Amen*” (**11:36**), and “*to the only wise God be glory forever through Jesus Christ*” (**16:27**).

I like to think of glory as **the incandescent splendor of God’s beauty and majesty**. The new heavens and the new earth will be the dimension of future existence, which will be illuminated by the glory of God (see **Rev 21:11, 23**). Thus, the hope of glory refers to the end of the often painful pilgrimage of the self toward God and the reanimation of the body in the glory that God has always intended it to be (see **1 Cor 15:43; 2 Cor 4:17; Titus 2:10**). Glory is the place where groanings are no more, where groanings are only a faint memory of what came before, a wrinkle in time amidst an eternity of peace, praise, and joy with God.

R. Kent Hughes: Romans 8:28 does not mean, as is commonly thought, that “everything will turn out okay in this life.” It means, rather, that everything will work out for our ultimate good. These words have our eternal rather than our temporal good in mind. **Bishop Anders Nygren** writes:

Just as the present aeon is to be followed by eternity, it has already been preceded by an eternity. Only when we see our present existence set in God’s activity, which goes from eternity to eternity, do we get it in right perspective. Then man comes to see that everything that comes to the Christian in this life—and consequently the sufferings of the present too—must work together for good to him.

The specific good will be seen when we are glorified as we are **conformed to the image of Christ**. The Christian should not view present distresses and reversals as ultimately destructive. In some manner they are preparing us for the future revelation of God’s glory. At that time we will clearly see what we have always known: “. . . *that for those who love God all things [pleasures, pains, experiences of tremendous suffering, disappointments] work together for good, for those who are called according to his purpose.*” Thus we have the foundation for a massive confidence such as that of Philipp Melanchthon. It really is true! God does cause everything that happens to us (even the evils inflicted by others, even the presently inexplicable disappointments) to work out for every believer’s eternal good. This immense confidence rests on the certainty of our redemption, which began before time with God’s foreknowledge and will end beyond time with our glorification. This certainty is described in **verses 29, 30** in what commentators have called “**the golden chain.**” Notice that the emphasis is on **God doing everything.**

Leedy Greek NT Diagrams:

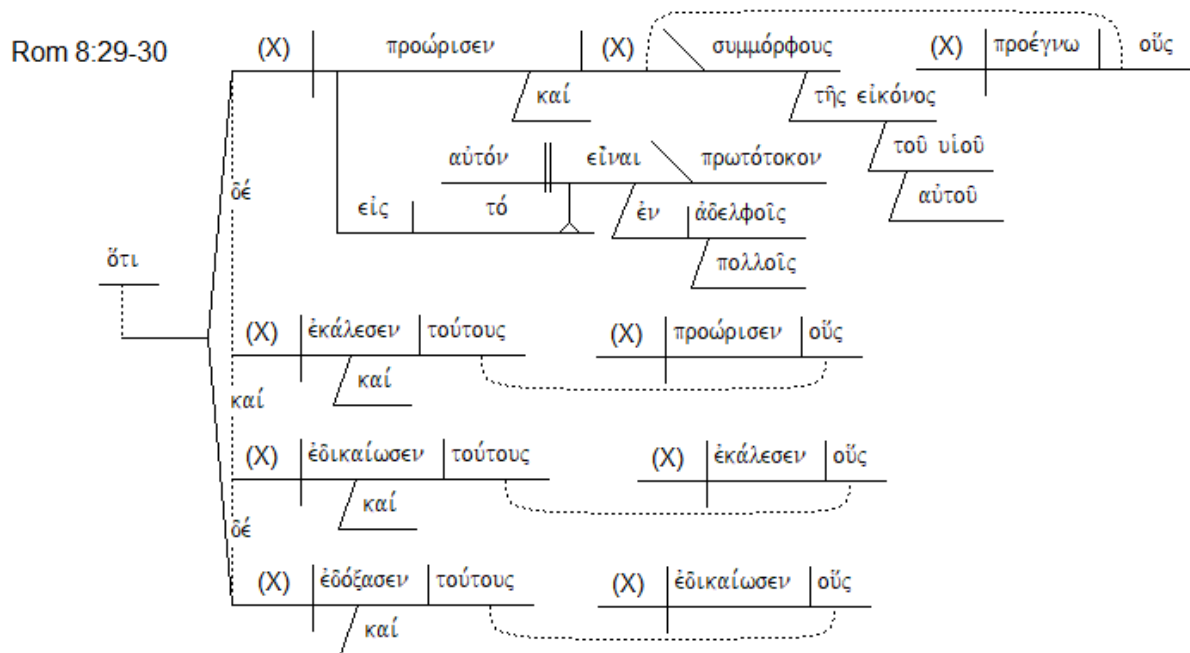
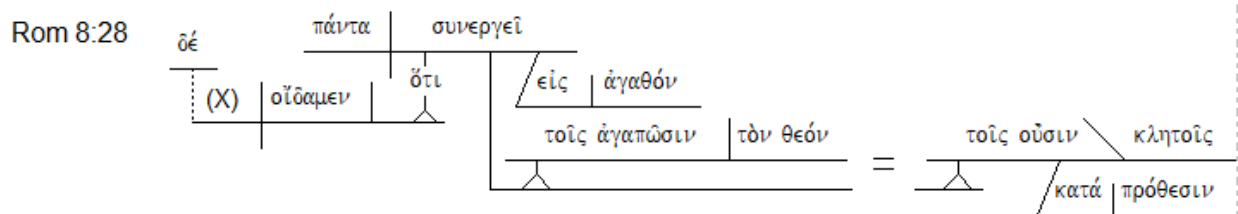

Frank Thielman:

- 28a Explanation (of 26a) And **we know that for those who love God all things work together for good,**
b for those who are called according to [God's] purpose.
- 29a Basis (for 28a) Because **those whom he** knew beforehand he also
b decided beforehand would be similar in form to the image of his Son,
c Purpose in order that he might be the firstborn among many brothers ↯
and sisters.
- 30a Explanation (of 29) And **those on whom he decided beforehand**
b Expansion (of 30a) **these he also called;**
- c and **those whom he called,**
d Expansion (of 30b–c) **these also he justified;**
- e and **those whom he justified,**
f Expansion (of 30d–e) **these also he glorified.**

TEXT: ROMANS 8:31-39

TITLE: GOD IS FOR US – NO POSSIBLE SEPARATION

BIG IDEA:

NO MATTER WHAT WE FACE, SINCE GOD IS FOR US THERE IS NOTHING STRONG ENOUGH TO SEPARATE US FROM THE LOVE OF GOD

INTRODUCTION:

John Toews: Paul concludes every major section of the letter with a carefully phrased confessional or hymnic statement. The first major argument, **1:18 - 4:25**, concluded with a confessional statement in **4:24-25**. The third major argument, **chs. 9-11**, concludes with a grand poem in **11:33-36**. Paul concludes his second major argument in a similar way. **Verses 31-39** are a carefully crafted summary statement, really a “victory song of salvation.” With much repetition, the summary makes one basic assertion: **God is on our side**. . .

The **structure** of the summary is **question and answer**. Paul asks six questions, in two different sequences.

- The main theme of the text is framed in the first three questions, **vv. 31-32**. The second question, **v. 31b**, states the theme. The third question, **v. 32**, provides the proof: God has given us the Son.
- The second set of questions, **vv. 33-39**, repeat the first set of questions and expand the theme.

There is a progression in the length of the questions throughout the series. In the first series, question two is longer than one, and three is longer than two. The same pattern holds in the second series. Paul is clinching an argument by **repetition upon repetition**. Let no one forget, let no one doubt, **God is for us**.

Thomas Schreiner: The magnificent and exalted style in these verses is immediately apparent, and the beauty of the text may be unrivaled in all of Pauline literature. These verses function as an *inclusio* with **5:1–11** since both texts feature the confidence that is characteristic of the hope of believers. The text also brings chapter 8 to a climax. . .

In **verses 31–39** Paul reflects back on **5:1–8:30** and considers the greatness of what God has accomplished on behalf of believers. With rhetorical questions he drives home his message about the hope of believers.

Douglas Moo: A call to celebrate our security in Christ makes for a natural conclusion to what Paul has been teaching in these chapters. He adduces two reasons for us to celebrate our security:

- the work of God for us in Christ (**vv. 31–34**) and
- the love of God for us in Christ (**vv. 35–39**).

S. Lewis Johnson: Our subject for this morning in the exposition of the word of God is, “**God for Us or No Separation**.” God for us, anything added merely detracts from these words. It’s the

moment for silence and for reverence and worship. Even the commentators of the Epistle to the Romans become remarkably reserved and quiet at this point in their exposition. There is an element here of awed silence like that that falls on a group of people who watch the sun rise from a mountaintop, or for the first time, gazes out over the Atlantic Ocean or the Pacific Ocean at that vast expanse of water, which almost takes away your breath as you think of the illimitable character of it.

Frank Thielman: Main Idea -- In this passage Paul summarizes the gospel as he has explained it in **1:18 – 8:30** and draws from his explanation the conclusion that God loves his chosen people, will protect them from all their enemies, and one day will give them eternal life in a restored creation. The proof of God's commitment to his people in these ways is the death of his own Son on their behalf and the present reign of his Son together with him over the universe. The death, resurrection, and heavenly session of Christ mean that, however difficult existence may become for God's people, they will always be the objects of his loving care.

Michael Bird: The heart of the argument set forth in **Romans 8** is for assurance in the unshakable and sovereign love of God. To this end Paul constructs a rhetorical peroration in **8:31 – 39** to recap the key tenets of his argument about assurance and to make an emotional appeal to his audience for their consent to the pathos of his speech. The main premise, harking back to **5:1 – 11**, is that God's love is a love that comes to us in Christ and triumphs over all adversity. Paul's words constitute a dramatic crescendo to the discourse as he weaves together the well-worn motifs of cross, resurrection, grace, justification, the priesthood of Christ, the exaltation of Christ, suffering, triumph, and divine love. Paul puts his rhetorical pedal to the homiletical metal as he waxes eloquently about the majestic span of God's love for us in Christ Jesus. Paul is almost hymn-like in his account of how God's love in Christ Jesus secures a victory for humanity over all things that might conceivably oppose them. . .

And so ends our tour of the cosmic cathedral of **Romans 5-8**, quite rightly in the spiral of the highest power, looking toward the heavens, choir singing below us, bells ringing around us, reminding us to rest in God's love for us.

I. (:31-32) NOTHING CAN DEFEAT US SINCE GOD IS ON OUR SIDE

A. (:31) Thesis Statement = God Is for Us

*“What then shall we say to these things?
If God is for us, who is against us?”*

Frank Thielman: Paul introduces the passage with a series of three rhetorical questions.

- The first question (**8:31a**) shows that he is about to draw an important conclusion from the preceding argument (“*What, then, shall we say in view of these things?*”).
- He then provides a pithy summary of that conclusion (8:31b) in a second rhetorical question (“*If God is for us, who is against us?*”).
- A third rhetorical question supplies the reason why he can say that God is on the side of believers: if God's Son died for his people, God is not likely to deny believers any other good thing (**8:32**).

The rest of the passage explains this thesis in greater detail. . .

The question “*who is against us?*” then does not assume that God’s people have no enemies (cf. **8:35–36, 38–39**) but that these enemies cannot be victorious over them, however strong they may seem to be. Paul’s rhetorical question comes out of the same understanding of God’s saving power that prompted David’s rhetorical question about Goliath: “*For who is this uncircumcised Philistine, that he should defy the armies of the living God?*” (**1 Sam 17:26**; cf. **Pss 27:1; 118:6–7; Isa 50:9; 54:17**).

B. (:32) Supporting Argument = God Will Bring Us to Glory

*“He who did not spare His own Son, but delivered Him up for us all,
how will He not also with Him freely give us all things?”*

Thomas Schreiner: The evidence of God being for us is supremely manifested in the giving of his Son. And now that he has given us the greatest gift (his Son), he will surely give us every other gift that we need.

Frank Thielman: The term “*indeed*” (γέ) often appears in combination with other words at the beginning of a clause to **emphasize** the entire clause. Here it highlights just how dramatically God has shown himself to be “*for*” his people (**8:31**). . .

The “*all things*” that God freely gives his people should be understood within the broader context of **Romans 8:17–30**. There Paul had said that after God’s people had suffered with Christ they would be **glorified** with him (**8:17**) and had then explained that when believers were glorified “*the creation*” would also “*be set free from slavery to decay*” (**8:21**). It is likely, then, that when Paul speaks here of God graciously giving “*all things*” (τὰ πάντα) to believers “*with*” (σύν) Christ he refers to **God’s gift of a restored universe** to his people. This interpretation becomes even more likely in light of Paul’s frequent use of the expression “*all things*” with the article (τὰ πάντα) to mean “*the universe*” (cf. **11:36; 1 Cor 8:6; Eph 3:9; 4:10; Col 1:16–17**; and especially **Phil 3:21**).

S. Lewis Johnson: if it is true that Jesus Christ has died for us, all human beings, then every human being must be saved: for everything else is less, “*He that spared not his own Son, but delivered him up for us all, how shall he not with him also freely give us all things?*” But, the Scriptures make it plain, **not all are saved**. Many are lost. Many are lost now and lost forever. It is therefore clear that when we read, “*He that spared not his own Son, but delivered him up for us all,*” he means us **all who are believers**. Sometimes I have friends say to me, “Where do you get **particular redemption** in the Bible?” My friend, it’s on every page of the Bible practically. Throughout the Bible it speaks of what God does for his people, for his own, and occasionally for his elect. Here is a text that is plain as day, “*He that spared not his own Son, but delivered him up for us, how shall he not with him also freely give us all things?*”

Michael Bird: To put it differently, if God is willing to hand over his beloved Son for us (**a hard thing**), he must surely be willing to give us all things (**an easy thing**). Paul does not explicitly state the scope of the “*all things*” that are graciously bestowed on believers. However, the “*with him* [i.e., *Christ*]” clues us into thinking that he has in mind the inheritance and glory that believers share with Christ (see **Rom 8:17**).

Steven Cole: The context is, Do you want to endure faithfully tribulation, distress, persecution, famine, nakedness, peril, and sword for Jesus' sake (**8:35**)? God, who loved you so much that He sent His own Son to die for your sins, will give you the grace and strength that you need to bear up under every trial for the sake of the gospel. God, who has done the most for you by giving His own Son, will help you endure every trial that you go through for Christ's sake. Because of His great love for you, He will bring you safely to glory. Paul applies three great truths to help us persevere:

1. The truth of God's sovereignty in saving us demands a response of worship and total submission.
2. The truth that God is for us in the gospel means that we must evaluate all opposition and difficulties in light of God's grace.
3. The truth that God has done the greatest thing for us in the sacrifice of His own Son means that He will supply us with all that is needed for life and godliness.

Application:

- Respond in Confidence
- Trust the Power of God
- Rest in the Unchanging Eternal Love of God

II. (:33-34) NOTHING CAN CONDEMN US SINCE GOD IS ON OUR SIDE

A. (:33a) Remember Our Protected Identity = the Elect of God

"Who will bring a charge against God's elect?"

Frank Thielman: After this introduction, Paul illustrates his thesis by describing two threatening contexts that cannot overwhelm God's people (**8:33–34, 35–37**).

- First, he describes a **judicial context** in which charges are brought against them. Christ's death, resurrection, and continuing intercession on behalf of God's people mean that no charge against them can be successful (**8:33–34**).
- Second, he describes a situation of **general social upheaval** in which the love of Christ for his people might be obscured by their suffering. Here too, however, the display of Christ's love in his death for God's people (cf. **5:8; 8:32**) gives them the resources they need to gain a decisive victory over these evils (**8:35–37**). . .

God's people need to fear neither the final day of judgment nor the accusations of their detractors in the present. God has accepted them and put them right with himself. His decision in their favor is final and trumps any other negative judgment against them.

B. (:33b) Remember the Judge (God the Father) Is on Our Side

"God is the one who justifies;"

C. (:34) Remember God the Son Is on Our Side – His Fourfold Ministry

“who is the one who condemns?”

1. Christ Died for Us

“Christ Jesus is He who died,”

2. He Was Raised

“yes, rather who was raised,”

3. He is at the Right Hand of God

“who is at the right hand of God,”

4. He Intercedes for Us

“who also intercedes for us.”

Frank Thielman: Here Paul seems to imagine Christ, the “*anointed*” (χριστός) king, appealing to his coregent God on behalf of his people and on the basis of his atoning death. The thought is close to **Ephesians 1:20–23** where God gives the resurrected, enthroned, and victorious Christ “*as head over all things to the church*” (**Eph 1:22**).

Steven Cole: Paul asks two parallel questions: “*Who will bring a charge against God’s elect?*” And, “*Who is the one who condemns?*” In answering those questions he doesn’t tell us anything that he hasn’t already said. But he wants to hammer home God’s answer to guilt one more time so that we will know how to win the battle when guilt attacks.

God’s answer to guilt is that He justifies His elect through Christ’s mediation on our behalf.

First, let’s think about who charges us with guilt.

1. The world, the devil, and our consciences seek to condemn us with guilt.

A. THE WORLD CHARGES US OF BEING GUILTY OF HYPOCRISY, INTOLERANCE, SELF-RIGHTEOUSNESS, AND OTHER SINS.

B. THE DEVIL CHARGES US AS GUILTY WHEN WE FALL SHORT OF GOD’S HOLINESS.

C. OUR CONSCIENCES CHARGE US WITH GUILT WHEN WE KNOW THAT WE HAVE SINNED.

2. After confession, answer charges of condemnation with God’s promise to justify His elect through Christ’s mediation on your behalf.

If God has chosen you and justified you through the effective mediation of the crucified, risen, exalted, and praying Savior, then you can answer any charge against you. If God, the sovereign Judge of all has said (**8:1**), “*Therefore there is now no condemnation for those who are in Christ Jesus,*” then you are *not* condemned!

III. (:35-39) NOTHING CAN SEPARATE US FROM GOD'S LOVE

A. (:35-36) Don't Let Suffering Catch You by Surprise

“Who shall separate us from the love of Christ? Shall tribulation, or distress, or persecution, or famine, or nakedness, or peril, or sword? 36 Just as it is written, ‘For Thy sake we are being put to death all day long; We were considered as sheep to be slaughtered.’”

Douglas Moo: But Christ not only defends us; he loves us and enters into relationship with us, and nothing will ever separate us from that love.

Frank Thielman: Disasters that normally separate people from the people who love and care for them are not able to distance believers from the sacrificial love of Christ who now lives and reigns with God.

John Toews: Paul's thesis is that **God is for us**. The best evidence is Jesus. Therefore, the third and final question, is there anyone who can separate us from the love of Christ (v. 35)? The tribulation list that follows uses the language of religious persecution (suffering, anguish, persecution) and end-time suffering and deprivation (famine, nakedness, danger, sword). The list is supported by the quotation of **Psalm 44:22**, a text that was also used by Jewish leaders to interpret the deaths of the Maccabean martyrs for the sake of the law. The people of God suffer, are killed and slaughtered for God's sake. But God's children triumph, literally win a glorious victory, through the enablement of the one loving them. The one loving them is Christ in v. 35 and God in v. 39. Jesus as the Messiah embodies the covenant love of God so that the two can be cited as synonyms of the divine love for the children of God. Paul has been and is persuaded (perfect tense) that **none of the powers of the cosmos** will be able to separate God's children from the love of God.

B. (:37) Suffering Actually Magnifies Our Victory and Security

“But in all these things we overwhelmingly conquer through Him who loved us.”

Steven Cole: God's great love for us in Christ Jesus our Lord enables us to be more than conquerors through every trial for His sake.

1. God's great love for us is not diminished or terminated by our failures, shortcomings, or sins, because it goes back to God's choice of us before the foundation of the world.
2. God's great love for us is not threatened or undermined by all sorts of adversity, including martyrdom.
3. God's great love for us is supremely demonstrated in Christ Jesus our Lord, who gave Himself for us on the cross.
4. God's great love for us will be consummated in heaven, but we should experience it now as the foundation for victory as we face trials for His sake.

C. (:38-39) The Strongest Power Imaginable Can Never Separate Us from God’s Love

“For I am convinced that neither death, nor life, nor angels, nor principalities, nor things present, nor things to come, nor powers, 39 nor height, nor depth, nor any other created thing, shall be able to separate us from the love of God, which is in Christ Jesus our Lord.”

Frank Thielman: “Neither angels nor rulers” may refer to types of transcendent beings, whether good (2 Thess 1:7; 1 Tim 5:21) or evil (cf., e.g., 1 Cor 4:9; 6:3; Eph 6:12; Col 2:15), and that is certainly the assumption of virtually all interpreters from early times to the present. Paul can, however, use the term “rulers” (ἀρχαί) unambiguously of visible, earthly governmental authorities (Titus 3:1), and if he uses it that way here, then the rhetorical pairing of opposites would be preserved. Angels would refer to invisible messengers, whether good or evil, and rulers would refer to governmental authorities, whether just (cf. Rom 13:3–4) or unjust (cf. 2 Cor 11:32–33).

DEVOTIONAL QUESTIONS:

- 1) How does our identity as God’s elect fortify us in times of persecution?
- 2) How would you counsel a believer who has excessive problems with guilt?
- 3) Why do I ever grumble or show discouragement or despair regarding the difficult circumstances I face in life?
- 4) How can I better appreciate the heights of God’s love for me?

QUOTES FOR REFLECTION:

Frank Thielman: The Gospel’s Meaning: God Loves and Protects His People through His Son Jesus Christ (8:31–39)

- a. Thesis: Christ’s death shows that God has taken his people’s side (8:31–32)
- b. Two illustrations (8:33–36)
- c. No judicial threat can succeed against God’s people (8:33–34)
- d. No amount of social upheaval can succeed against God’s people (8:35–36)
- e. Summary: Nothing in God’s universe can block the love that God has for his people as he has shown it in the death and resurrection of Jesus Christ (8:37–39)

R. Kent Hughes: The story is told that during a crisis in the Civil War a timid civilian sought out President Lincoln and said, “Oh, Mr. President, I am most anxious that the Lord should be on our side!” Lincoln replied, “That gives me no anxiety at all. The thing I worry about is being on the Lord’s side!” Lincoln was correct in his application for that moment. But in the context of

salvation there is no doubt—“*God is for us.*” Melancthon found this to be true. When Martin Luther stood tall at Worms, it was, to use Carlyle’s words, “the greatest moment in the modern history of man.” But there was another man with him, a shy man of peace. He was there because he believed “*If God is for us, who can be against us?*” Luther and Melancthon *contra mundum*. The logic of our text, seriously applied, pushes us to the heights of confidence. It means more than God being graciously disposed toward us. It means he is for us in all that he does. We may be defeated at this moment, but evil will never prevail. We are always being led to victory in Christ.

S. Lewis Johnson: Now the apostle, I say, has been expounding these great truths, **God’s for us**. He governs all of the steps of our way. He works everything together for good to those who are the called according to his purpose. He set forth the purpose in that great five-fold way and now he asks the question in **verse 31**, “*What shall we then say to these things? If God be for us, who can be against us?*” When he says, “*What shall we then say to these things?*” he means these things he’s just been talking about, that divine continuing providence, that divine election, that divine foreordination. One looking at the intimate choice, one looking at the gold. He’s talking about the divine calling that reached down and selected us and brought us to the knowledge of Jesus Christ. Some of us out of the insurance business, some out of another business, some while we’re in school, some as we sat around the table and heard our fathers and mothers expound the word of God. He called us and justified us. And he is so certain to glorify us that he puts it in the past tense, “*What shall we then say to these things?*” All of them speak with the loudest kind of message to the effect that God is for us.

Now we have **adversaries**. The Bible says we have adversaries. Paul says we have adversaries. In fact, he says we have adversaries right in this passage. Listen to him, “*What shall separate us from the love of Christ? Shall tribulation (that’s an adversary), shall distress (that’s an adversary), shall persecution (that’s an adversary), shall famine (that’s an adversary), nakedness, peril, sword?*” And then if that’s not enough he speaks in **verse 28** of death, life, angels, principalities, powers, things present, things to come, height, depth, any other creation, these are our adversaries, but in the midst of all of our adversaries, Jesus Christ is for us by virtue of his sacrifice. And I want to say to you that when he says, “*If God be for us,*” there’s no doubt about it. In fact, even in the original text, this is a **first class condition**. This is the basis upon which he’s supposing this result. We could render it “*since God is for us.*” What he means is, in the light of this, it’s clear God’s for us. Now if he’s for us, **who can be against us?**

We began this chapter, “*There is therefore now no condemnation,*” we conclude with **no separation**. The love of God will always sustain us. We have need to fear nothing that lies before us. I think it’s rather strange that the apostle **locates our confidence in the love of God rather than in the strength of God**. When we think of the anxiety that we have as we face the problems of life, we’re inclined to want to talk in human terms, we want to talk about strength. So when we say anxiety comes, I was able to meet it because I found myself strong. But in the Bible, **opposed to anxiety, is love and the love of God**. The reason, of course, is simply this, that it is the assurance of a loving God with all of his capacities that enables us to face anxiety. **Courage is anxiety suppressed**. Confidence in the love of God is anxiety gone. Gone, no longer there. We have a God who has loved us and proved it in the death of the Son. Everything else is less and having given the most, he’ll give the rest.

Leedy Greek NT Diagrams:

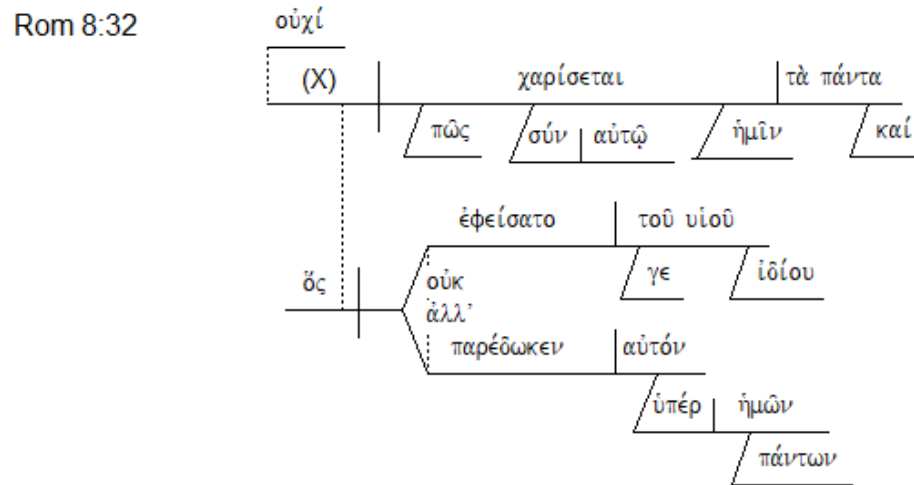
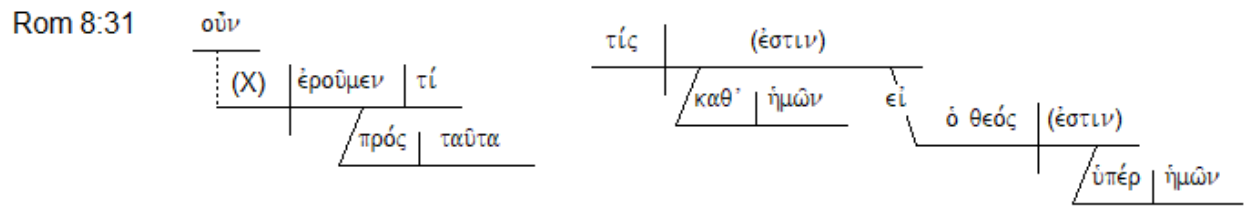

Rom 8:33-34

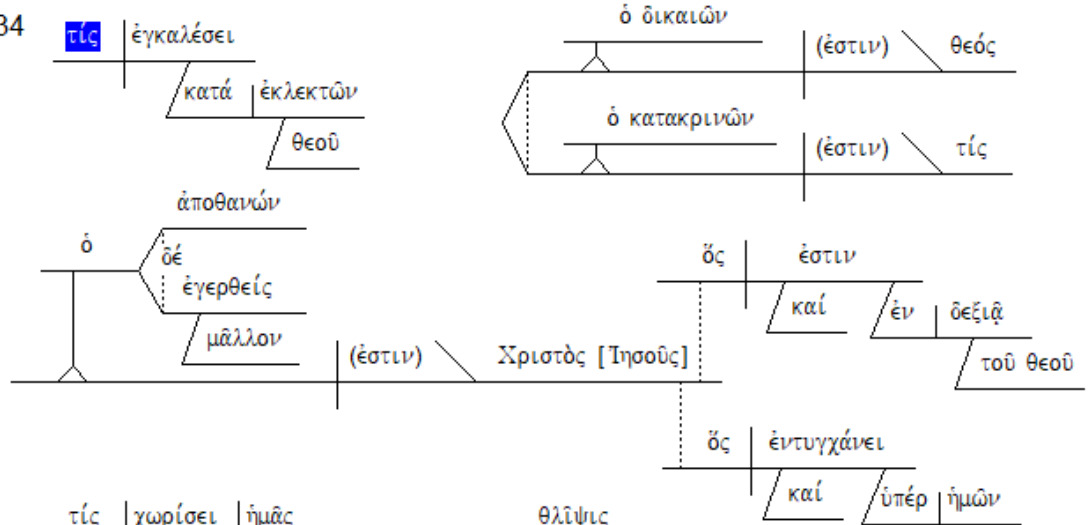

Rom 8:35

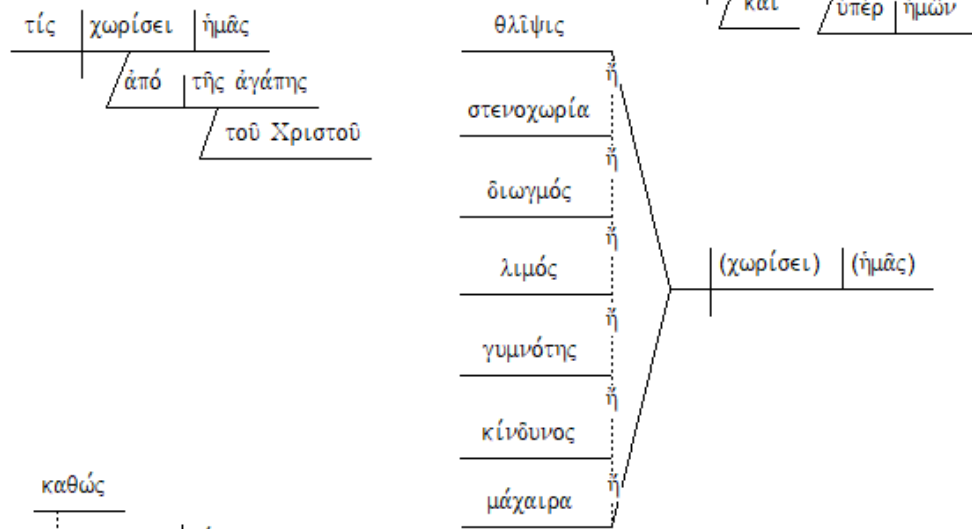

Rom 8:36

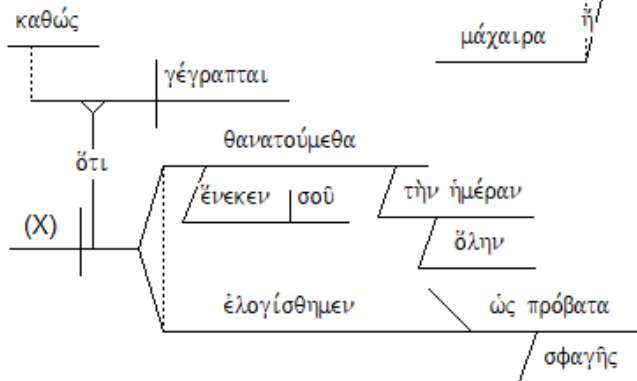

Rom 8:37

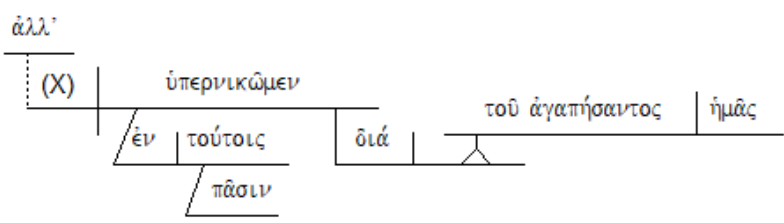

Rom 8:38-39

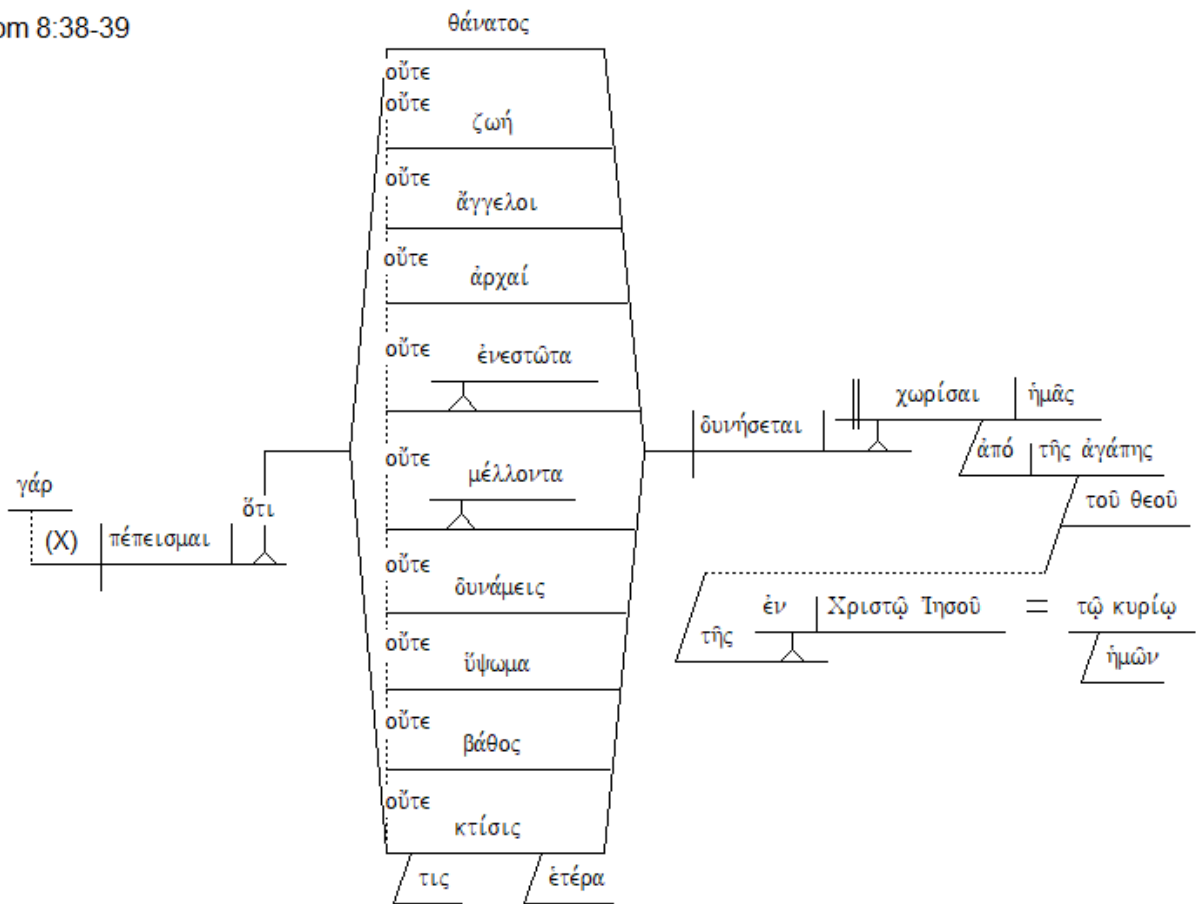

Frank Thielman:

- 31a Rhetorical Question (Conclusion) **What, then, shall we say in view of these things?**
- b Rhetorical Question (Introduction) If God is for us,
who is against us?
- 32a Identification He who indeed did not spare his own Son but
| handed him over
| for us all,
b Rhetorical Question (Expansion) **how will he not ...**
also,
with him,
... graciously give
to us
the whole created order?
- 33a Rhetorical Question (Series—no. 1) **Who will bring charges against God's chosen people?**
- b Exclamation **God is the one who justifies!**
- 34a Rhetorical Question (Restatement of 33a) **Who is the one who condemns?**
- b Exclamation **Christ is the one who has died, and, even more,**
c Sequence **was raised,**
d Sequence **who also is at the right hand of God,**
e Sequence **who also intercedes for us!**
- 35a Rhetorical Question (Series—no. 2) **Who shall separate us from the love of Christ?**

b Rhetorical Question (List)	Affliction or distress or persecution or famine or lack of clothing or danger or sword?		
36a Verification	Just as it is written that,	"For your sake we are being killed all day long; we are counted as sheep destined for slaughter." (Psa 44:22)	
b Explanation			
37a Contra-expectation (Sphere)	But in all these things	we are winning a sweeping victory through the one who loved us.	
b Assertion			
c Agency			
38a Basis (of 37b)	For I am persuaded		
b List (Contrast)	that	neither death	nor life,
c List (Contrast?)		neither angels	nor rulers,
d List (Contrast)		neither things present	nor things future,
e List		nor powers,	
39a List (Contrast)		nor height	nor depth,
b List		nor any other created thing	
c Content (of 38a)			will be able to separate
d Object			us
e Separation			from the love
f Subjective Genitive			of God
g Sphere			in Christ Jesus 
			our Lord.

TEXT: ROMANS 9:1-13

TITLE: ISRAEL'S FAILURE CANNOT COMPROMISE GOD'S FAITHFULNESS

BIG IDEA:

THE SAD FAILURE OF THE NATION ISRAEL DOES NOT CONTRADICT THE SOVEREIGNTY OF GOD IN CHOOSING THE RECIPIENTS OF HIS GRACIOUS PROMISES

INTRODUCTION:

John MacArthur: Several questions must be answered because Paul has been presenting a gospel that has been preached to all nations. He said that in **chapter 1**. And he has characterized the lostness of all men and the redemption of all men. And in presenting this gospel of salvation by grace through faith to all who believe, whatever their national heritage, he naturally poses this very important question that would be asked by a Jew or anyone who knew the special place of the Jews: What does this mean in relation to Israel? Are they no longer God's chosen people? Are they permanently set aside? Has God cancelled His promises to them? Is the Gentile church the new Israel? And then this question: How can Jews, to whom this gospel came first and who are the sons of Abraham, be rejecting it if in fact it is the truth? Wouldn't they be the most likely to recognize its truthfulness? And then there's this question: If Paul has been saying in chapter 8, particularly, how secure we are in Christ and how nothing can ever separate us from Him or His love, how can we be sure God's going to keep that promise if He broke His promises to Israel? I mean, if God didn't keep the Jews in the place of covenant blessing, why should we believe He'll keep us there no matter what he says? . . .

The unbelief of Israel is not inconsistent with God's promise.

Frank Thielman: Although Paul was grieved over the relatively small number of Israelites who had believed the gospel in his own time, this sad situation did not impugn either the gospel in which he had just expressed such confidence or the Scriptures themselves. The word of God has not wrecked on the rocks of Israel's unbelief. Rather, the present ethnic configuration of the people of God is consistent with the portrait of God in Scripture. There God is free to choose who will belong to his people and who will be hardened in rebellion against him, and he is free to make what, from a human perspective, are unconventional choices about those to whom he will show mercy. . .

In **9:6–13** Paul states the thesis he will develop in **9:7 – 11:32** and then begins to support this thesis from Scripture. Israelite unbelief does not mean that God's promises to be faithful to his people have failed (**9:6**). Scripture demonstrates that the children of God and the physical children of Abraham are overlapping but different groups (**9:7–9**) and that God freely chooses his children without regard to their relative virtues and vices or their family connections (**9:10–13**).

I. (:1-5) SADNESS -- BECAUSE ISRAEL HAS FAILED TO TAKE ADVANTAGE OF THEIR SPIRITUAL PRIVILEGES

A. (:1-4a) Sadness of Apostle Paul Embraced – Burden for Lost Souls

1. (:1) Reality of His Grief -- True Testimony

*“I am telling the truth in Christ, I am not lying,
my conscience bearing me witness in the Holy Spirit,”*

James Stifler: The transition from the eighth chapter is abrupt. The sudden change may be accounted for psychologically. The apostle had just been contemplating the certainty of the glory of the sons of God; his heart goes now to the other extreme, the failure and misery of his own countrymen.

Frank Thielman: Paul calls on two witnesses to the truthfulness of what he is about to say: himself and his conscience. His appeal to himself is especially emphatic, using both a positive statement that he speaks the truth (cf. **2 Cor 4:2**) and a negative statement that he does not lie (cf. **Gal 1:20**). His conscience can serve as a second witness since he conceived of it as an internal gauge of how well one’s actions conformed to one’s moral standards (cf., e.g., **Rom 2:15; 2 Cor 1:12**).

Thomas Schreiner: The conscience is contemplated as a confirming entity that substantiates Paul’s claim to truthfulness. The conscience, of course, is fallible and does not invariably judge matters aright (cf. **1 Cor. 8:7, 10, 12; 1 Tim. 4:2; Titus 1:15**). Any notion that Paul’s conscience on this occasion is fallible is excluded, since his conscience bears witness ἐν πνεύματι ἁγίῳ (*in the Holy Spirit*). In this instance his conscience has been informed by and is under the control of the Holy Spirit, so the Roman readers can be assured of the truthfulness of his assertion (so **Lohse** 2003: 265).

2. (:2) Intensity of His Grief -- Crushing Concern

“that I have great sorrow and unceasing grief in my heart.”

Alva McClain: The Jew might have brought the charge against Paul that he did not care for his kinsmen. They might have said, "He is so wrapped up in this new gospel that he has forgotten all about his people."

Steven Cole: IT IS POSSIBLE TO HAVE GREAT SORROW OVER THE LOST AT THE SAME TIME THAT WE HAVE GREAT JOY IN CHRIST.

Paul has just exuberantly told of God’s great love for us in Christ, but now he tells of his “*great sorrow and unceasing grief*.” He wasn’t bi-polar, going from a super-high to a super-low! Rather, he was “*as sorrowful, yet always rejoicing*” (**2 Cor. 6:10**). It’s possible to be both sorrowful and yet rejoicing at the same time. . .

If I focused on the sad condition of lost people to the extent that I had *only* great sorrow and unceasing grief in my heart, I would be very depressed. I wouldn’t be able to sleep at night. I wouldn’t reflect the joy of the Lord. On the other hand, if I were so filled with the joy of my salvation that I *never* felt any sorrow or grief for the lost, I would be very self-centered and calloused. I need *both* the joy of salvation that moves me to want others to know the same joy,

along with sorrow over the sad condition of the lost, so that I reach out to them with kindness and compassion.

3. (:3-4a) Subjects of His Grief -- Ethnic Empathy

*“For I could wish that I myself were accursed,
separated from Christ for the sake of my brethren,
my kinsmen according to the flesh, 4 who are Israelites,”*

John MacArthur: But the Jews, you see, need to know where his heart is. And so, he gives them a look at his heart at the beginning of **chapter 9** and then again at the beginning of **chapter 10. He loved his people.** The fact that he went to the Gentiles and the fact that he preached the truth about salvation by grace through faith, not law through works, doesn't mean that he was anti-Jewish. The fact that he confronted the lost Jew with his sinfulness and the emptiness of his system was not an act of hate but an act of what? Of love, for love calls men away from sin to salvation. Love calls men away from the delusion to the truth. So they missed the point. The reason he confronted the false system of Judaism and called men to Christ was not because he hated the Jewish system or the Jewish people but because he loved them so much.

Steven Cole: LOST PEOPLE WON'T CARE HOW MUCH YOU KNOW UNTIL THEY KNOW HOW MUCH YOU CARE.

I didn't originate that phrase, but it captures a truth that oozes out of **verse 3**, where Paul says that he could wish himself accursed and separated from Christ for the sake of his fellow Jews. That is such a radical statement that Paul felt the need to say (**9:1**), *“I am telling the truth in Christ, I am not lying, my conscience testifies with me in the Holy Spirit ...”* Some of his Jewish enemies thought that Paul had forsaken his Jewish heritage for the sake of the despised Gentiles. But before God, Paul testifies that he had such deep concern for the Jews that he would be willing to give up his salvation if it meant that they could be saved!

Thomas Schreiner: The soteriological import of these terms in Paul can hardly be denied. Soteriology continues to be the issue in Rom. 9:22–23, which contrasts *“vessels of wrath prepared for destruction”* with *“vessels of mercy that were prepared beforehand for glory.”* Paul often uses the word ἀπόλεια (*apōleia, destruction*; **Phil. 1:28; 3:19; 2 Thess. 2:3; 1 Tim. 6:9**) for eschatological destruction, while he frequently uses δόξα (*doxa, glory*) to describe the eschatological splendor awaiting believers (**Rom. 2:10; 8:18; 1 Thess. 2:12; 2 Tim. 2:10**; cf. **Col. 3:4**; cf. **E. Johnson** 1989: 127). Finally, the argument in **Rom. 9:30 – 11:32** substantiates the idea that eschatological salvation is the matter at hand. What troubles Paul in **9:30 – 10:21** is that Israel has failed to believe in Christ and therefore is not saved. What gives him hope in **chapter 11** is that God has promised to remove ungodliness from Jacob and that ultimately *“all Israel shall be saved”* (**11:26–27**). **Any attempt, therefore, to sever the historical destiny of Israel from salvation in this context is unpersuasive.** Paul's heart is rent with sorrow because so many of his kindred have rejected the message of the gospel and are therefore destined for judgment.

B. (:4b-5) Spiritual Privileges of National Israel Not Embraced

1. Adoption as Sons

“to whom belongs the adoption as sons”

Frank Thielman: “Adoption” (υιοθεσία) recalls God’s designation of Israel in Scripture as his “*firstborn son* [υιός]” (**Exod 4:22–23**; cf. **Deut 14:1**; **Jer 31:9**; **Hos 11:1**; **Jub. 1:24–25**), a status that now belongs to believers whatever their ethnicity (**Rom 8:15, 23**). Unbelieving Israel does not have “adoption” in this sense because this form of adoption arises from union with God’s Son (**8:14–17**). Paul’s anguish over unbelieving Israel probably arose in part from this disparity.

2. Shekinah Glory “*and the glory*”

Frank Thielman: “*Glory*” (δόξα) refers to the experience of God’s presence and is reminiscent of God’s meeting with his people at Sinai, in the tabernacle, in the temple, and at his coming at the restoration of all creation (e.g., **Exod 24:16–17**; **29:23**; **33:18–22**; **40:34–35**; **1 Kgs 8:11**; **Ps 26:8**; **Isa 60:1–2**). The hope for this glory, however, now belongs preeminently to those who have believed the gospel (**5:2**; **8:18, 21**).

3. Covenants “*and the covenants*”

John MacArthur: Covenants with Abraham, **Genesis 12:15 to 17**. Covenant with Moses, and that all the way from **Exodus 19 to 31**, repeated in **Deuteronomy 29 and 30** and given an even added dimension. Covenant with not only Abraham and Moses but David, **2 Samuel 7**, the covenant of a great and eternal kingdom, reigned over by a great and glorious son of David. God promised them a nation through Abraham. God promised them blessing through Moses. God promised them eternal glory through David. I mean, they were the recipients of the covenants. They were the nation to be blessed.

4. Law “*and the giving of the Law*”

Michael Bird: The emphasis here falls on the God-given nature of the law, not its negative effects as usual, especially the privileges of receiving it (**Deut 31:10 – 11**; **Ezra 7:6, 10**; **Neh 8:1**; **Ps 78:5**; **Sir 45:5, 17**). It is probably identical to the idea expressed in **3:2** that the Jewish people were “*entrusted with the very oracles of God.*”

5. Temple Service “*and the temple service*”

James Dunn: The worship of the temple cult is specifically in view (cf. **Josh 22:27**; **1 Chron 28:13**; **1 Macc 2:22**; **Philo, Decal. 158**; **Spec. Leg. 2.167**; **Josephus, War 2.409**; **Heb 9:1, 6**). Paul spiritualizes or secularizes the concept in **12:1** (see on **12:1**; also on **15:16**), and that broader usage presumably lies below the surface here (cf. his use of λατρεύειν in **1:9** and **Phil 3:3**), though there is no evidence that non-Christian Jews yet gave it a wider reference prior to the destruction of the temple (Str-B, 3:262).

6. Promises

“and the promises,”

Michael Bird: The “*promises*” undoubtedly refers to the promise of blessings given to Abraham and the other patriarchs, which figure prominently in Galatians and Romans (**Gen 12:1-2; 15:1-5; 17:1-27; Rom 15:8; Gal 3:16, 21; Wis 12:21**).

James Dunn: The promises in view would include not only the inheritance of the land (see on **4:13**), but also the blessing of the nations (**Gen 12:2–3; 18:18; 22:18; 26:4; 28:14; Sir 44:21; Acts 3:25**).

7. (:5) Lineage -- Family Connections

a. Pedigree

“whose are the fathers,”

b. Legacy

“and from whom is the Christ according to the flesh, who is over all, God blessed forever. Amen.”

Thomas Schreiner: To ascribe blessedness to Christ after identifying him with θεός (God) fits more naturally into the context, since the Messiah sharing the divine nature is the consummation of Israel’s privileges. Indeed, an ascription of deity to Christ heightens the profundity of Paul’s grief. Not only have the Jews rejected the Messiah, who is ethnically related to them, but they also are spurning one who shares the divine nature with the Father.

R. Kent Hughes: Paul hurt so much at the thought of Israel’s rejection of Christ that he was willing to forgo Heaven and suffer damnation if that would bring their salvation. Though Paul knew such a bargain was impossible, his emotions were intensely real. Why? He loved his fellow countrymen and longed for their salvation. He was proud of his Jewish heritage. His hurt was intensified by his awareness of the vast privileges from which they had not benefitted—especially the fact that the Messiah “*who is God over all, blessed forever*” (v. 5) came from them.

Frank Thielman: Although the emphasis in the passage lies on Israel’s failure to realize the perfection of the gifts God has given to them because of their rejection of the gospel, it is significant that Paul describes these gifts as still the possession of unbelieving Israel. The church has not taken these gifts from Israel but only realized prior to Israel the eschatological direction in which they were pointing. Israel’s continuing possession of these gifts points forward, then, to Paul’s argument in **11:25–29** that eventually “*all Israel will be saved*” and that God’s “*gifts and calling*” will then be seen as irrevocable.

II. (:6-9) SUCCESS – BECAUSE GOD HAS NOT FAILED IN HIS REVEALED PLAN TO SAVE THE CHILDREN OF PROMISE – EXAMPLE OF ISAAC

A. (:6a) Culpability Does Not Lie with God’s Word

“But it is not as though the word of God has failed.”

Douglas Moo: Paul must defend God’s faithfulness to his promises to Israel. For if God has gone back on his word to Israel, then a deep chasm between the Old and New Testament opens up, and the good news can no longer claim the God of Israel as its author. The whole plan of salvation crashes.

B. (:6b-8) Clarification Regarding Identity of the Children of Promise

1. (:6b-7a) Distinction between Physical Israel and the Believing Subset

*“For they are not all Israel who are descended from Israel;
7 neither are they all children because they are Abraham’s descendants,”*

Thomas Schreiner: Paul begins by asserting the thesis of these chapters. God’s word, **God’s promises to Israel, haven’t failed** (cf. **Isa. 40:7–8**). He never promised that every ethnic Israelite would be saved. Most commentators locate the οὐ (*ou, not*) in **9:6b** with the first part of the sentence, but it is more likely that it belongs with the final part. The meaning of the sentence is not affected significantly on either reading, for the intention in any case is to say that **not all ethnic Israelites belong to the true Israel, the people of God**. Identifying the precise referent in the second use of the term “*Israel*” is controversial. Paul almost certainly labels the church “*the Israel of God*” in **Gal. 6:16** (**Schreiner** 2010b: 381–83), and this follows from the truth that the church is the true circumcision (**Rom. 2:28–29; Phil. 3:3**) and the true family of Abraham (**Rom. 4:9–25; Gal. 3:7, 14, 29**). Moreover, gentiles are grafted onto the olive tree of Israel (**Rom. 11:17–24**), and OT texts that refer to Israel are applied to gentiles who believe in Christ (**9:24–26**). To see the term “*Israel*” as referring to both Jews and gentiles in Christ, therefore, would harmonize nicely with Pauline thought. Nonetheless, in this particular context it seems more likely that the second use of “*Israel*” is **restricted to ethnic Jews who believe** in Jesus as Messiah. Nowhere in **Rom. 9–11** is the term “*Israel*” transferred to the church, and the issue that Paul confronts here is whether the promises made to ethnic Israel will be fulfilled. Furthermore, in **Rom. 9:27–29** and **11:1–6** Paul speaks of a **remnant**, and in these instances it is clear that he refers to a remnant **within Israel** (so **Thielman** forthc.), and thus the same is probably true here. In subsequent verses (**vv. 7–13**) Paul argues that a winnowing process has always occurred in the midst of **ethnic Israel**.

John MacArthur: *For they are not Israel who are of Israel.* What does he mean by that? He means that God never promises unconditionally to each offspring of Abraham covenant blessing just because he’s an offspring of Abraham. Did you get that? You see, the Jew believes that because he is fleshly descending from Abraham he therefore is included in the covenant; because he is a Jew by birth he is therefore a child of promise. He is therefore redeemed, if you want to put it in our parlance. He is therefore saved. He is therefore going to go to heaven. But God never intended that all Israel would be redeemed Israel, for they are not all the true Israel who are of the fleshly Israel.

Listen to it this way. **The real Israel is contained within the natural Israel.** To put it another way, spiritual Israel is contained within physical Israel. And though the nation, now listen very careful distinction, though the nation was chosen as a nation to be a vehicle to transmit the Scriptures, to be a vehicle to propagate the message of monotheism, one God, though the nation was chosen to be a witness nation, **the choosing of the nation as an entity does not mean that**

every individual within that nation was also chosen to salvation. So the fact that Israel does not believe, that many individuals don't believe doesn't cancel the promises because God never intended in His sovereignty that every Jew would believe, but that within the physical Israel there would be a believing remnant. **The nation was elected to privilege but only individuals are elected to salvation.** The real Israel is the Israel of faith and throughout all of the history of Israel there have been faithless Jews. It isn't anything just common to the time of Christ.

2. (:7b) Divine Choice of Isaac

“but: ‘through Isaac your descendants will be named.’”

James Stifler: That the real Israel should not be as wide numerically as the natural Israel is supported by the further statement that even Abraham’s natural seed were not all of them children of the covenant. The promise was limited to Isaac, and Ishmael was left out, although he also is called Abraham’s “seed” (**Gen. 21:13**). Paul thus keeps the all-important point foremost, that the promise to Israel was a vital promise, still holding, but not on the condition of mere natural descent.

John MacArthur: Now the point here is this, that it's obvious that God chooses some of the sons of Abraham to blessing, not all of them. And it's obvious from the very start, He rejected Ishmael. He accepted the line to come through Isaac. And I don't know if you remember but Abraham had another wife by the name of Keturah through whom he had a couple more sons. And they too were rejected. So just being a child of Abraham doesn't put you in the place of blessing. And that's verified by the very illustration of the case of Isaac. The chosen nation was to come through the loins of Isaac. Paul's argument is very simple. Ishmael and Isaac demonstrate that **God never intended all those naturally descending from Abraham to receive covenant blessing.** The point is, God is **selective**, or better, God is **elective**. And the key word is "*called*," **chosen by sovereign will.**

Thomas Schreiner: “*shall be named*” -- it denotes an **effective call** that creates what is desired (cf. **Rom. 4:17; 8:28, 29; 9:12, 24, 25, 26**). Indeed, there is probably an echo of **4:17**, where God “*calls things into being that do not exist*,” which in the context of **Rom. 4** refers to the birth of Isaac by God’s creative word. This interpretation of “*calling*” in **9:7** is also validated by the structure of the verses, for the parallel to “*calling*” in **verse 8b** is “*promise*” (ἐπαγγελία, *epangelia*). **The promise of God secures that which is pledged just as the call creates that which is intended.** Thus the thesis of **verse 6a** is defended. God’s promises have not and cannot fail because they are based on **his call**, which is always effective, and on **his promise**, which is guaranteed.

3. (:8) Distinction between Physical Children and Children of the Promise

“That is, it is not the children of the flesh who are children of God, but the children of the promise are regarded as descendants.”

C. (:9) Confirmation of God’s Word of Promise

“For this is a word of promise:

‘At this time I will come, and Sarah shall have a son.’”

Thomas Schreiner: Another controversy exists over whether the salvation promised here relates to **individuals** or **groups**. Many opt for the latter and exclude the former, because Paul focuses on the salvation promised to corporate Israel. I have argued at some length elsewhere that such a dichotomy is logically and exegetically flawed, since groups are always composed of individuals, and one cannot have the former without including the latter. At this juncture I should note that the selection of a remnant out of Israel implies the selection of some individuals out of a larger group. Moreover, the unity of **Rom. 9–11** indicates that individual election cannot be eliminated. In **chapter 10** believing in Jesus is an individual decision, even though Paul addresses Jews and gentiles as corporate entities. The individual and corporate dimensions cannot be sundered from each other in **chapter 10**, and the same principle applies to **chapter 9** (cf. Müller 1964: 76–77). Those who insist that corporate election alone is intended in **chapters 9 and 11** are inconsistent when they revert to individual decisions of faith in **chapter 10**. The three chapters must be interpreted together, yielding the conclusion that **both corporate and individual election are involved**.

Douglas Moo: The **initiative**, Paul makes clear again, is with God. Inheriting the promise is not based on birth alone; it depends on God’s gracious intervention.

James Dunn: Paul’s line of argument is clear: scripture confirms Paul’s earlier exegesis; the founding fathers show that Israel’s own election was not in terms of natural descent and law, but from the outset and thus characteristically in terms of promise and faith. Consequently, Paul implies, the Jews as a people cannot and should not object to Paul’s gospel; to do so is to misunderstand their own gospel (of election). . .

Jews who insist on “*works of the law*” as the indispensable mark of God’s chosen people are actually denying not simply the gospel but also their own election—an intolerable situation indeed for one who desperately wants to be loyal both to his Jewish heritage and to the revelation of Christ.

III. (:10-13) SOVEREIGN CHOICE – BECAUSE WHOM GOD SAVES DEPENDS COMPLETELY ON GOD – EXAMPLE OF GOD’S CHOICE OF JACOB OVER ESAU

A. (:10) One Act of Conception between Rebekah and Isaac

“And not only this, but there was Rebekah also, when she had conceived twins by one man, our father Isaac;”

B. (:11) Destiny of Twins Determined by God’s Sovereign Choice

“for though the twins were not yet born, and had not done anything good or bad, in order that God’s purpose according to His choice might stand, not because of works, but because of Him who calls,”

Frank Thielman: The genitive-absolute construction broadens Paul’s case that God chose Jacob over Esau apart from their physical relationship to Isaac and Rebecca. Now Paul includes the further thought that God chose Jacob over Esau without regard to the moral quality of their lives. The purpose clause states that God worked this way to preserve his sovereign freedom to determine the identity of those through whom he would accomplish his purposes.

Thomas Schreiner: His failure to insert **human faith** as the decisive and ultimate basis for God's election indicates that God's call and election are prior to and the ground of human faith (see **D. Moo** 1996: 583).

Michael Bird: In sum, Paul has been telling the story of Abraham, Isaac, and Jacob with a view to establishing an important premise: God always intended that only some of Abraham's progeny would carry his saving purposes forward. That is the view of election that "stands" or "remains." It had nothing to do with merits, but only with the divine purpose. On the one hand, anyone familiar with the Torah would find that unobjectionable; after all, God chose Isaac not Ishmael, God chose Jacob not Esau. There was a holy line reaching from Abraham to Israel. On the other hand, it is the application that Paul draws from this principle that would have aroused indignation. Paul was not merely suggesting that the promises bypass some of Abraham's descendants, but that physical descent does not seem to matter at all.

Even worse, the precepts of the Torah, even if followed with the utmost scruples, do not merit salvation for anyone. The identity of Israel was never determined by lineage or law, but exclusively decided by God's effectual call and mercy. **Barclay** observes the shocking nature of Paul's claim: "Paul has directly or indirectly ruled out numerous possible qualifying criteria for divine selection: birth (natural rights of descent), status (comparative 'greatness'), and action ('works'), all forms of superiority humanly ascribed or achieved.... Thus the only principle that Paul will identify as operative in Israel's history is the principle of call/election, which operates by mercy alone." The upshot is that when it comes to the divine promises, as **N. T. Wright** puts it, "what counts is grace, not race."

C. (:12) Primacy of Firstborn Supremacy Overturned

"it was said to her, 'The older will serve the younger.'"

D. (:13) Distinction in God's Treatment of Jacob and Esau

"Just as it is written, 'Jacob I loved, but Esau I hated.'"

Frank Thielman: The term "hated" (ἐμίσησα) is both harsh and startling, but it is also **hyperbole**. Paul probably thought of it as clarifying his point that God freely chose one individual over another (cf. **Luke 14:26**).

R. Kent Hughes: This **relative use of hate** is also found in **Luke 14:26** when Jesus says, "*If anyone comes to me and does not hate his own father and mother and wife and children and brothers and sisters, yes, and even his own life, he cannot be my disciple.*" Jesus obviously does not mean his followers are to hate their relatives, but that they are to love him so much that love for family appears as hatred in comparison.

More severe interpretation:

John MacArthur: Now some have tried to say in that verse what it means is, "*Jacob have I loved and Esau have I loved less.*" It doesn't say that. It says *He hated him*. I mean, let God hate if He wants to hate, and He hates evil and He hates idolatry and He hates paganism and so He hates Esau. He hates. You can read about God's hate in **Psalm 5:5**, **Psalm 11:5**, **Psalm 26:5**, you can

read it in **Proverbs 6:16** where it says *six things the Lord hates, yea seven are an abomination to Him*. In **Jeremiah 44 verse 4**, the abominable thing I hate, says God. You can read it in **Hosea 9:15, Amos 5:21, Zechariah 8:17** and **Malachi 2:16** and many other places. God hates. He hates evil, He hates wickedness, He hates idolatry. And He hated what He saw in the seed of Esau. It says at the end of **verse 4 of Malachi 1** that against Edom the Lord has indignation forever.

Douglas Moo: Some think “*hate*” may mean simply, in Semitic fashion, “love less.” But the Old Testament context points in a different direction. That context is clearly covenantal, so that “*love*” means, in effect, “**choose**,” while “*hate*” means “**reject**.”

James Dunn: The final quotation of **Mal 1:2–3** (“*Jacob I loved, but Esau I hated*”) rounds off the first stage of the argument introduced by **v 6**—“*the word of God has not failed*.” It has not failed, it has simply been **misunderstood**—misunderstood by the people whose scriptures they are! The word of God was always in terms of election, of **God’s purpose fulfilled through his free choice**, never in terms of the natural kinship of blood ties, never in terms of a community characterized and bounded by particular ritual acts (works of the law). The word of God has not failed (as the success of the gospel shows); it is Israel according to the flesh who have failed. By emphasizing God’s selection of Jacob afresh (“*Jacob I loved*”) the Malachi proof text repeats and confirms the character of God’s covenant through Jacob, as a relationship given and maintained by God’s free choice. But it also introduces a further element: the choice of Jacob was also a choice against Esau. This negative corollary to the election of Isaac and Jacob was always implicit in **vv 7–12**, but now Paul deliberately brings it to the fore to introduce the **transition** to the next phase of the argument.

Those Not Chosen Are Still within the Purpose of God (9:14–23).

Steven Cole: By this point, some of you probably are thinking, “If God accomplishes His purpose through His free, gracious choice of some, while He rejects others, **then He’s not fair!**” You may also be thinking, “If God is absolutely sovereign as you’ve described, then we’re all just robots with no will of our own. How can God condemn robots that He has programmed to act in a certain way?” If those are your questions, then I have correctly interpreted **Romans 9:6-13**, because those are precisely the questions that Paul anticipates and responds to (**9:14-18, 19-24**).

* * * * *

DEVOTIONAL QUESTIONS:

- 1) How can you demonstrate to the lost that you sincerely are **burdened for their souls**?
- 2) When it comes to **spiritual privileges**, do you see the parallel to children who grow up in Christian homes and in good church situations?
- 3) Why is the issue of **God’s reliability** so crucial to our spiritual security?

4) What is the value of the doctrine of **sovereign choice** for believers?

* * * * *

QUOTES FOR REFLECTION:

Frank Thielman: In **Romans 9:1 – 11:36** Paul acknowledges the tragedy of Israel’s rejection of the gospel (**9:1–5**) but then explains why this response does not pose a threat to the claims he has made about the consistency of the gospel with Israel’s Scriptures (**9:6 – 11:32**). The means by which God shows himself faithful to Israel despite its present rejection of the gospel are unexpected and complex, and so Paul concludes this section of his argument with a statement of his amazement at the depth of God’s power and wisdom (**11:33–36**). Between its sorrowful introduction (**9:1–5**) and its awestruck conclusion (**11:33–36**), the argument proceeds in three steps.

In **9:6–29** Paul explains two principles from the Scriptures that show that the current ethnic configuration of those who believe the gospel is not inconsistent with God’s word. First, the Scriptures reveal that God’s true people have always been a smaller group than the number of Abraham’s physical descendants (**9:6–23**). Second, the Scriptures also support the notion that as God works out his historical purposes there will be times when gentiles outnumber Jews within the true people of God (**9:24–29**).

In **9:30 – 10:21** Paul answers a question that naturally arises from what he has just said about gentiles outnumbering Jews in the true people of God. How, from a human perspective, could this happen in light of the advantage over the gentiles that access to God’s law gives to Jews? Paul answers that their zeal for the law blinded unbelieving Jews to the righteousness that God offered them in the gospel.

In **11:1–32** Paul asks a question that naturally arises from the case he has just made that most Jews have rejected the righteousness of God in the gospel. Does this mean that God has also rejected them? Surprisingly, Paul says that this conclusion is not correct. Not only does a present remnant of Jewish believers exist (**11:1–10**) but eventually, when God has fully implemented his plan for history, vast numbers of Jews will be saved (**11:11–32**). Eventually, God will use Jewish rejection and gentile acceptance of the gospel (**9:30 – 10:21**) to save “*all Israel*” (**11:11–32**).

Alva McClain: After Paul has treated in general the issues of salvation, a particular problem arises. It is the problem of the Jewish nation and their relation to the gospel that Paul has been setting forth in the first eight chapters.

The Jewish people, as a nation, had not received the gospel. They had rejected the Christ. Paul knew that. Everybody knew it at that time. Only a few Jews were in the church. As a nation, they had rejected the gospel. As time went on, a great deal of opposition had arisen from his “*brethren according to the flesh*.”

The gigantic proportions of this problem now appear. The whole Old Testament was simply

packed with promises that God had made to this Jewish nation. They were Messianic promises, promises which went with the Christ, the Messiah. Now notice the paradoxical situation. If the Jewish nation will not accept Jesus as messiah, then the unbelieving Jew would say that there are two possible conclusions to be drawn.

- Either the gospel that Paul is preaching is not true,
- Or else, if it is true, then the promises of God to Israel have failed, because the Messiah and blessing to Israel were connected inseparably.

The Jew would say in essence that, either Jesus Christ is not the true Messiah or the Word of God has proven false. . .

The ninth chapter admits to the fact that the Jewish nation has not received the gospel, but it also declares that the Word of God has not failed. Why? Because some Jews have believed, and these Jews, says Paul, are a part of that elect remnant that the Old Testament tells about. So the conclusion is that there is always a continuing line of believers, in whom the promises of God are being fulfilled.

Douglas Moo: GOD'S RELIABILITY.

Can God be trusted to do what he says? This is the ultimate question Paul seeks to answer in **chapters 9–11**. God's dealings with Israel raise the question, but its implications go much further. If God indeed promised he would bless Israel and then turned around and blessed the church instead, he might do the same again. His promises to the church might in turn be fulfilled, for instance, in a completely different entity. His promises to me personally as a believer might not be reliable either. Absolute trust in God to accomplish what he has promised is fundamental to our security as believers.

Grant Osborne: To what lengths will we go to offer the gospel to someone else? Paul consistently loved the Jews. They are one group that still needs to hear the gospel. But there are others, too. Sometimes the barriers to overcome are racial, linguistic, or cultural. Other times the distance is nothing more than social or geographical. Our **lack of compassion** is directly addressed in Scripture: *"If anyone says, 'I love God,' yet hates his brother, he is a liar. For anyone who does not love his brother, whom he has seen, cannot love God, whom he has not seen"* (**1 John 4:20** NIV). One of our persistent prayers needs to be for more love.

Michel Bird: The argument can be summarized as teaching that God's saving righteousness is for everyone, not despite Israel, but precisely because of Israel. The underlying problem is that the gospel has brought a rupture within Israel that is now divided between "Israel according to the promise" (Christ-believers) and "Israel according to the flesh" (non-Christ-believing Jews). The rupture is not permanent, but will have an eschatological resolution since ethnic Israel's failure will be overpowered by God's faithfulness. The swarm of Gentiles who come to faith in the Messiah will provoke Israel to jealousy so that she will finally cling to her own Messiah. The present time of Israel's obduracy is tragic yet providential since it provides the occasion for the inclusion of Gentiles in God's saving purposes. In the meantime, Gentile Christians should not look down on these unsaved Jews since they themselves only get in on the coattails of Israel's promises. Instead they should heed the warning of Israel's example and look ahead to the day when all Israel will be saved. . .

In sum, by the end of **Romans 8**, Paul has developed the theological architecture, the literary connections, and the pastoral context in which he can intentionally deal with the subject of the gospel in relation to unbelieving Israel. The way he proceeds in **Romans 9 – 11** is as follows:

- (1) **9:1-5** describes Paul’s affirmation of Israel’s inherited privileges and his impassioned hope for Israel’s deliverance;
- (2) **9:6-29** describes Israel in the past with particular reference to God’s electing purposes;
- (3) **9:30 – 10:21** outlines the plight of Israel in the present and the necessity of a continuity mission to Israel;
- (4) **11:1-32** discusses Israel in the future with a warning to Gentile Christians not to treat Israel and Jewish Christians with contempt, coupled with an affirmation of Israel’s eventual deliverance; and
- (5) **11:33-36** is a doxology for the God who is wise as he is merciful.

David Thompson: When it comes to the matter of the sovereignty of God in salvation, many immature people actually become hostile, hateful and hold grudges against God and want to argue with Him. Really when you get right down to it, the argument concerning God’s sovereignty is this - can the will of man overtake or be more powerful than the will of God? If it comes down to a power struggle between the will of a human versus the will of God, who wins?

This discussion contextually follows what we saw last time. God had given all of those wonderful promises and privileges to Israel, but Israel had rejected them and Paul’s heart was very heavy. He knew that some misguided theologian would reason that God’s program had ceased with Israel because of this and, therefore, His Word really doesn’t mean much. Even though God had made those promises to Israel, since Israel rejected Him, His promises would have failed (**Romans 9:6a**). The thinking was that God’s sovereign will and Word had been thwarted by the rebellion of Israel.

GOD’S WORD IS DOING EXACTLY WHAT GOD’S SOVEREIGN WILL DETERMINES IN ELECTING PEOPLE TO SALVATION.

Bruce Hurt:

Summary of Romans 9-11		
Romans 9	Romans 10	Romans 11
Past Election	Present Rejection	Future Reception
God’s Sovereignty Israel’s Election by God	Man’s responsibility Israel’s Rejection of God	God’s Ways Higher God Not Rejecting Israel

Leedy Greek NT Diagrams:

Rom 9:1-2

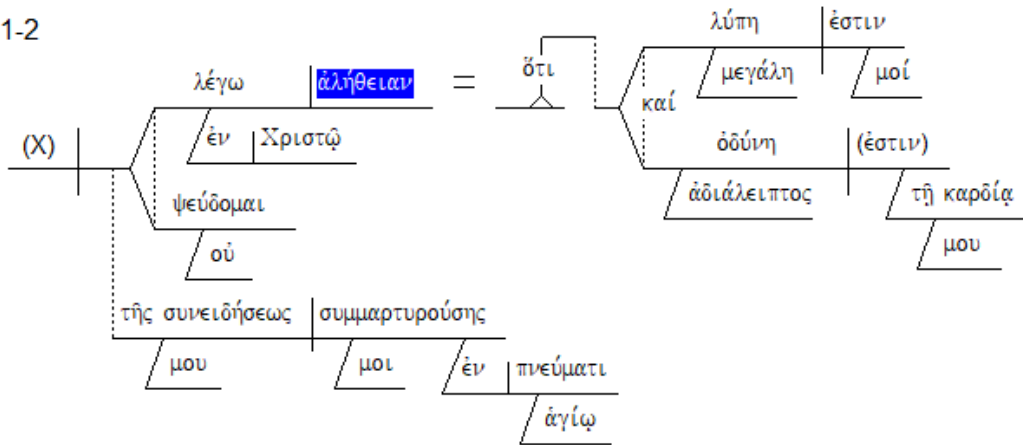

Rom 9:3-5

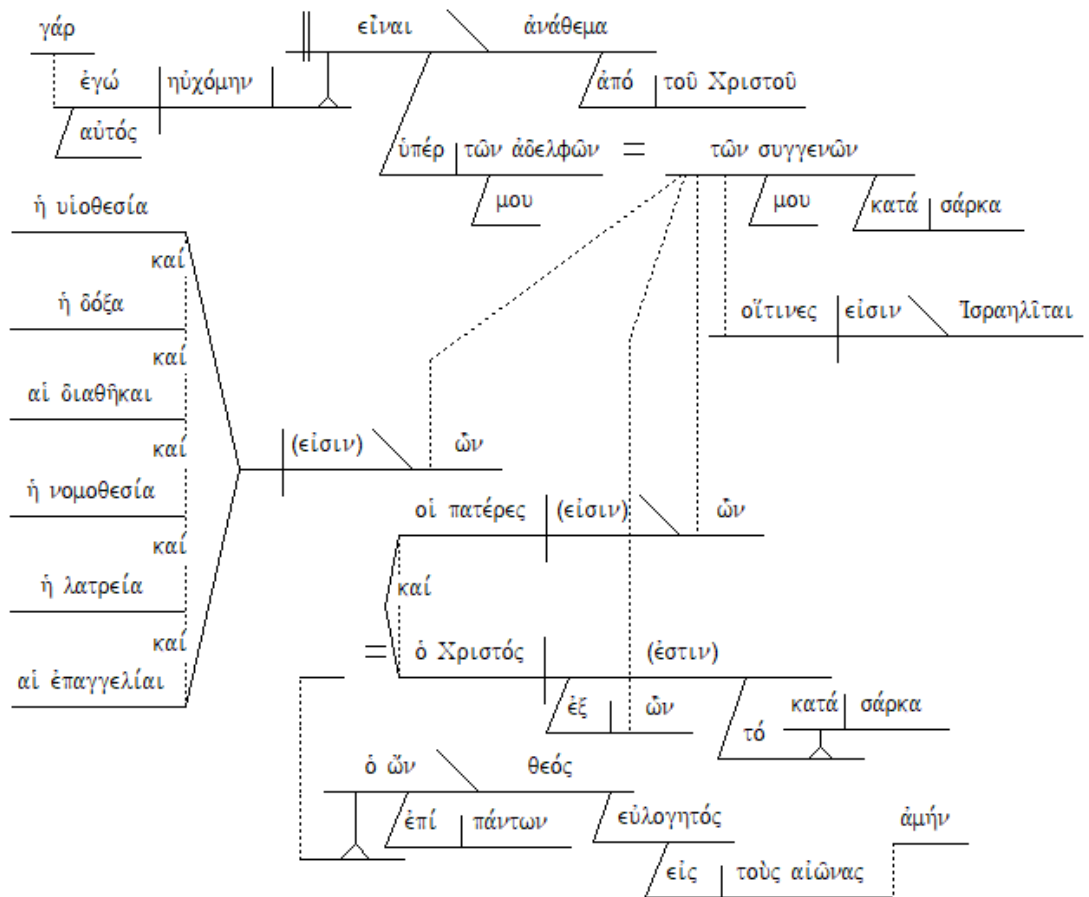

Rom 9:6-7

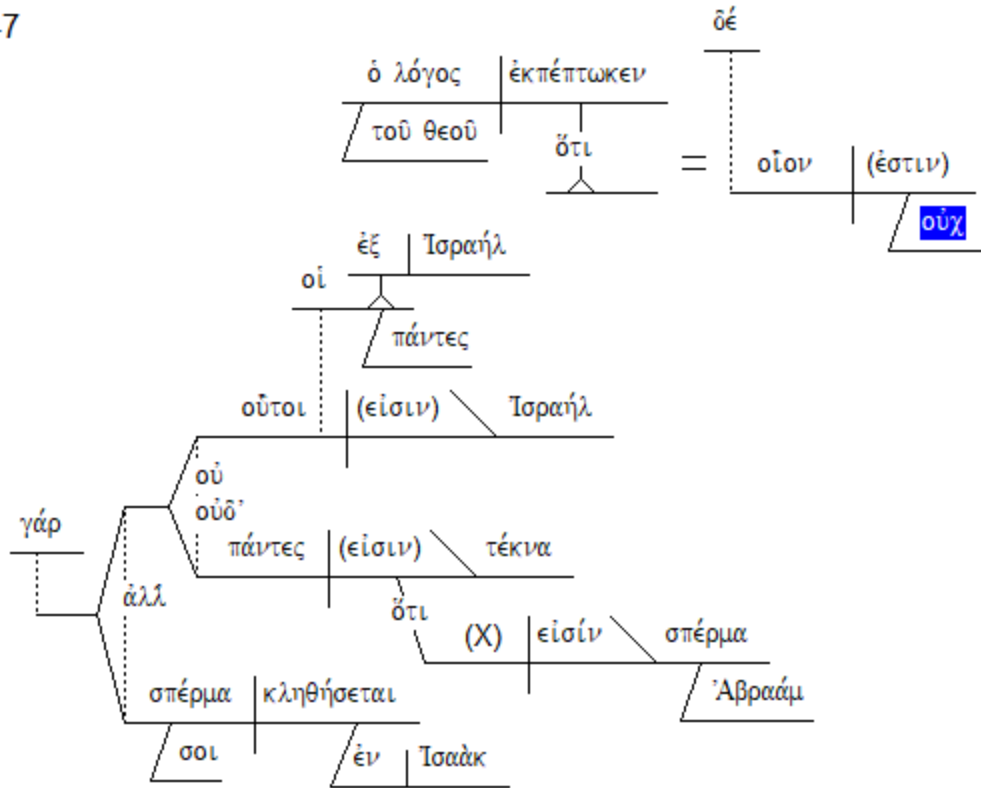

Rom 9:8

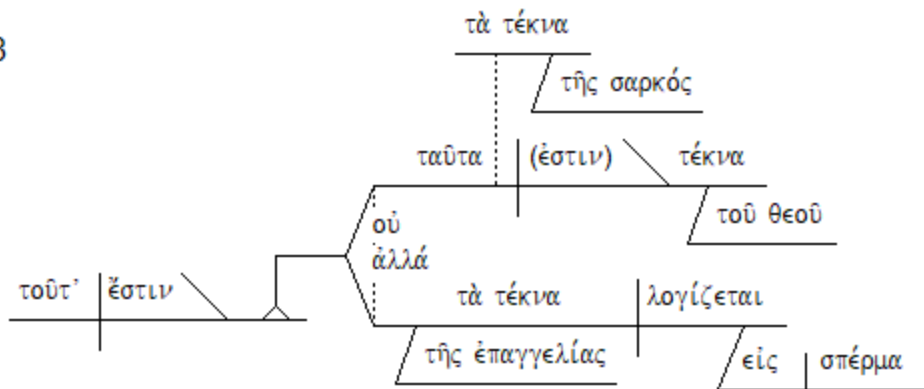

Rom 9:9

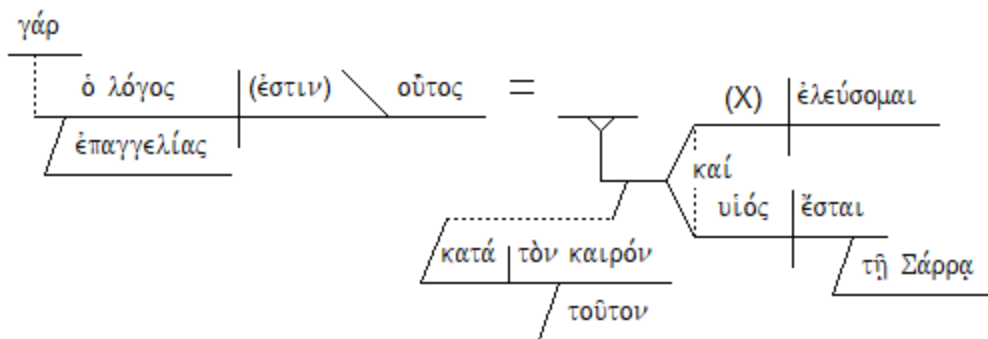

Rom 9:10-13

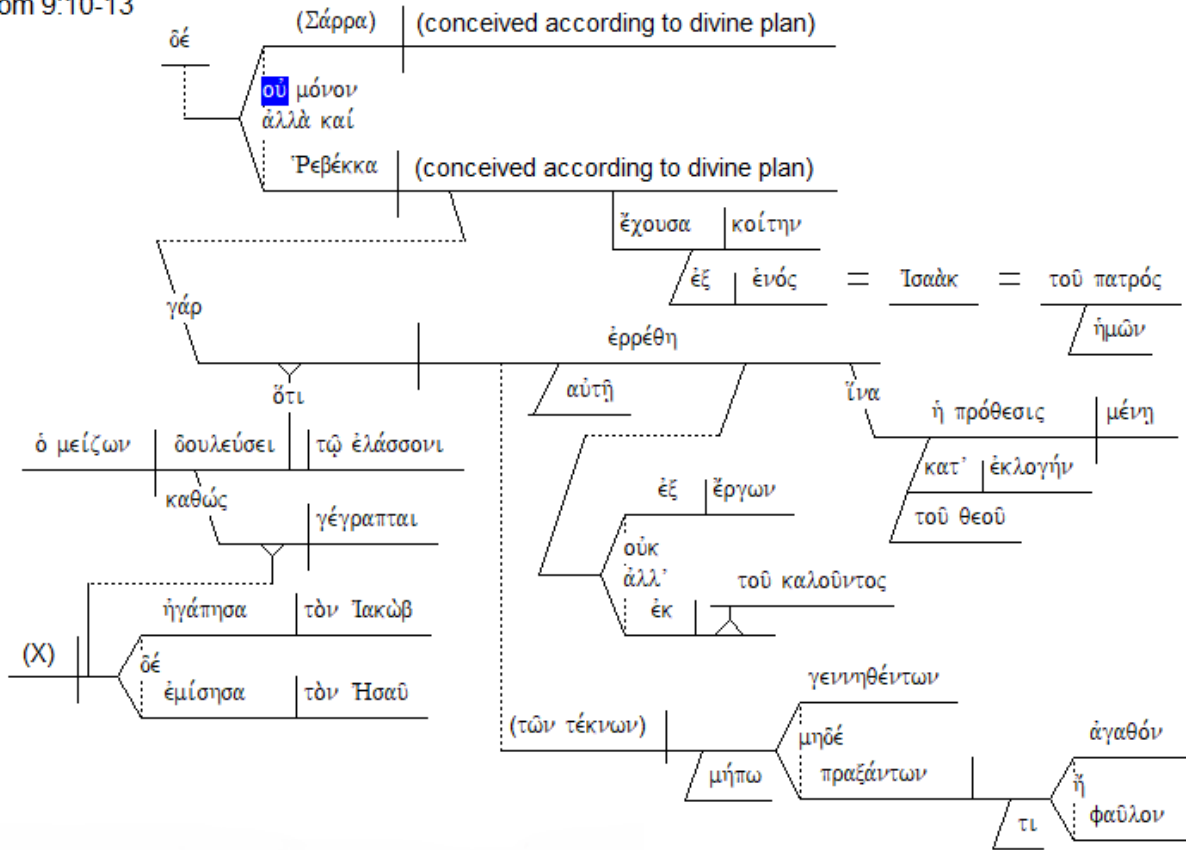

Frank Thielman:

1a	Assertion	I speak the truth
b	Sphere	in Christ,
c	Assertion	I am not lying, and
d	Confirmation	my conscience bears witness together
e	Sphere	with me
2	Content	in the Holy Spirit
		that great sorrow is mine, and
		there is constant distress in my heart.
3a	Explanation (of 2)	For I could almost wish
b	Apposition	that I myself were something cursed,
		separated
		from Christ
		in place of my brothers and sisters,
c	Apposition	my compatriots according to the flesh,
4a	List	who indeed are Israelites,
b	List	whose are the adoption as sons, and
c	List	the glory, and
d	List	the covenants, and
e	List	the legislation, and
f	List	the worship, and
g	List	the promises,
5a	List	whose are the fathers, and
b	List	from whom is the Messiah,
c	Description	as far as the flesh is concerned,
d	Identification	who is God over all, blessed forever. Amen.
6a	Assertion	But that is not to say that the word of God has failed.
b	Basis	For not all those from Israel are Israel;
7a	Expansion	nor because those from Israel are Abraham's offspring
		are they all children,
b	Contrast	but, "In Isaac will your offspring be called." (Gen 21:12)
8a	Restatement	That is, it is not the children of the flesh who are children of God,
b	Contrast	but the children of the promise are counted as offspring.
9	Basis	For the word of promise is this:
		"At this season I will come and Sara will have a son." (Gen 18:10, 14)
10	Expansion/ Concession	And not only so, but also Rebecca,
11a	Restatement (of 10)	—for although becoming pregnant by one man, our forefather Isaac
		although they were not yet born or
		had done anything good or evil,
b	Purpose (of 12b)	in order that the chosen purpose of God might stand firm
12a	Mears (of 11b)	not by works but
		by the one who calls—
b	Contra-expectation (of 10)	it was said to her,
		"The greater will serve the smaller," (Gen 25:23)
13	Verification (of 12b)	just as it is written,
		"Jacob I have loved, but Esau I have hated." (Mal 1:2-3)

TEXT: ROMANS 9:14-24

TITLE: GOD'S INALIENABLE RIGHTS

BIG IDEA:

WE HAVE NO BUSINESS QUESTIONING GOD'S SOVEREIGN CHOICE IN SALVATION (EXERCISING HIS RIGHT TO SELECTIVELY FORGIVE SOME BUT TO CONDEMN MANY)

INTRODUCTION:

Douglas Moo: As we have noted elsewhere in Romans, Paul writes this letter as a seasoned teacher. He knows the questions people will have about his teaching and raises them himself in order to head off misunderstandings. He knows his teaching about the sovereignty of God in election will stir questions and objections. Indeed, the questions are easy to anticipate; they are the same ones we ask when confronted with the unconditional election of God: "Isn't it unfair for God to act this way?" (cf. v. 14); and "How can God hold us responsible if he is the one who determines what happens?" (cf. v. 19). So before he goes on with his teaching about how God has selected only some Jews to be saved along with many Gentiles (vv. 24–29), he pauses to deal with them.

Spurgeon: If there is one doctrine in the world which reveals the enmity of the human heart more than another, it is the doctrine of **God's sovereignty**. When men hear the Lord's voice saying, "*I will have mercy on whom I will have mercy,*" they gnash their teeth and call the preacher an Antinomian, a High Calvinist, or some other hard name. They do not love God except they can make him a little God. They cannot bear for him to be supreme. They would gladly take his will away from him and set up their own will as the first cause.

Robert Haldane: Here the general conclusion is drawn from all the Apostle had said in the three preceding verses, in denying that God was unrighteous in loving Jacob and hating Esau. It exhibits the ground of God's dealings both with the elect and the reprobate. It concludes that **His own sovereign pleasure** is the rule both with respect to those whom He receives, and those whom He rejects. He pardons one and hardens another, without reference to anything but His own sovereign will, in accordance with His infinite wisdom, holiness, and justice. 'Even so, Father,' said our blessed Lord, 'for so it seemed good in Thy sight.' God is not chargeable with any injustice in electing some and not others; for this is an act of mere mercy and compassion, and that can be no violation of justice.

That mighty act of God in delivering Israel from bondage in Egypt demonstrated two great truths. He delivered Israel to exhibit His sovereign mercy on [those] whom He desires, and He raised up and destroyed Pharaoh to exhibit the corollary truth that He hardens those whom He desires. Only His divine desire determines which it will be.

Moses was a Jew, whereas Pharaoh was a Gentile; but both of them were sinners. Both were murderers, and both witnessed God's miracles. Yet Moses was redeemed and Pharaoh was not.

God raised up Pharaoh in order to reveal His own glory and power, and God had mercy on Moses in order to use him to deliver His people Israel. Pharaoh was a ruler, whereas Moses' people were slaves under Pharaoh. But Moses received God's mercy and compassion, because that was God's will. The Lord's work is sovereign, and He acts entirely according to His own will to accomplish His own purposes. The issue was not the presumed rights of either men but rather the sovereign will of God.

Denney: This interpretation of all human life, with all its diversities of character and experience, through the will of God alone, as if that will by itself explained everything, is not adequate to the facts. If Moses and Pharaoh alike are to be explained by reference to that will—that is, are to be explained in precisely the same way—then the difference between Moses and Pharaoh disappears. The moral interpretation of the world is annulled by the religious one. If God is equally behind the most opposite moral phenomena, then it is open to anyone to say, what Paul here anticipates will be said; *why does He still find fault?* For who withstands His resolve? To this objection there is really no answer, and it ought to be frankly admitted that the apostle does not answer it. **The attempt to understand the relation between the human will and the divine seems to lead of necessity to an antinomy** (the opposition of one law to another) which thought has not yet succeeded in transcending. To assert the absoluteness of God in the unexplained, unqualified sense of **Ro 9:18** makes the moral life unintelligible; but to explain the moral life by ascribing to man a freedom over against God reduces the universe to anarchy. Up to this point Paul has been insisting on the former point of view, and he insists on it still as against the human presumption which would plead its rights against God; but in the very act of doing so he passes over (in **Ro 9:22**) to an intermediate standpoint, showing that God has not in point of fact acted arbitrarily, in a freedom uncontrolled by moral law; and from that again he advances in the following chapter to do full justice to the other side of the antinomy—the **liberty and responsibility of man**. The act of Israel, as well as the will of God, lies behind the painful situation he is trying to understand. [*Expositor's Greek Testament*]

I. (:14-18) IS GOD UNJUST? ELECTION IS CONSISTENT WITH GOD'S CHARACTER

God is always just, but salvation is mainly an issue of God's right to exercise selective mercy.

Thomas Schreiner: God's faithfulness to his promises is assured, since it doesn't depend on human beings but on himself alone. But the manner in which Paul establishes the thesis raises a serious question about God's righteousness. If God calls apart from works and before people are born, then how can God be righteous? This issue occupies Paul in **verses 14–23**. Paul emphatically defends the righteousness of God in **verse 14**, repudiating out of hand any notion that God's actions are blameworthy. In **verse 15** Paul provides a reason (note γάρ, *gar, for*) why God is righteous: because he shows mercy to whomever he wishes. In the exegesis below, I will explain how this functions as a reason. A conclusion is drawn in **verse 16**: salvation is not obtained by human striving or by the human will. It depends solely on God's mercy. **Verse 17** constitutes a second reason why God is righteous, and thus it provides a reason for **verse 14** rather than being related to **verse 16**. God's righteousness is also displayed in evil that occurs. The example of Pharaoh verifies this, for God raised him up to display his power and name

through the whole earth. A conclusion for the entire paragraph is articulated in **verse 18**. If God shows mercy to some and withholds it from others, we can conclude that he chooses to have mercy on some, and he chooses to harden others.

Douglas Moo: Determining right or wrong, what is just or unjust, demands a standard for measurement. That standard is ultimately nothing less than God's own character. God, therefore, acts justly when he acts in accordance with his own person and plan. This is precisely the point Paul makes in **9:15–18**. The argument falls into two parallel parts, each with a quotation from the Old Testament (**vv. 15 and 17**) and a conclusion drawn from the quotation ("*therefore,*" **vv. 16, 18**).

Steven Cole: Is God Unfair?

1. As the righteous Sovereign over all, it is outrageous to think that God could treat anyone unjustly. . . . to raise the question of fairness presupposes that you have rights and that your rights are being violated. If you have no rights, then you have no basis to claim that someone is treating you unfairly. Because we all have sinned without excuse thousands of times against God's holy standards, we have no right to accuse Him of being unjust if He did not grant us mercy and salvation. His justice would only bring us what we deserved. (**9:14**)

(Cf. parable of **Matt. 20:1-16**)

2. As the righteous Sovereign over all, God is free to show mercy to whomever He wishes (**9:15-16**).

3. As the righteous Sovereign over all, God is free to harden whom He wishes, to display His glory (**9:17-18**).

A. (:14) Thesis Statement

"What shall we say then? There is no injustice with God, is there? May it never be!"

John Toews: The question is profoundly Jewish. The question is not, "is election unjust?" Jews believed in election; God had elected them as a people. Rather, the question is, is God unrighteous to the covenant by electing some within Israel and not all?

Frank Thielman: God's refusal to allow any human quality to influence his choice of Isaac and Jacob over Ishmael and Esau may seem arbitrary and therefore unfair, but that impression cannot be right.

B. (:15-16) Example of God's Sovereign Dealings with Moses

1. (:15) God Does What He Purposes

"For He says to Moses, 'I will have mercy on whom I have mercy, and I will have compassion on whom I have compassion.'"

Frank Thielman: The quotation comes word for word from **Exodus 33:19b LXX**, and both Paul and his audience must have known its wider context. That context emphasizes mercy as a primary characteristic of God's nature (cf. **Exod 3:14–15; 33:19a; 34:6–7**), but also God's

refusal to acquit the guilty (**Exod 34:7**) and his right to choose the objects of his mercy (**Exod 33:19b**). Paul believed that God was abundantly merciful and extraordinarily patient with those who rebelled against him (**Rom 9:22**), desiring their repentance (**2:4; 10:21**). He also believed, however, that everyone who received God's wrath justly deserved it (**1:18–3:20, 23**) and that whereas mercy was a primary and critically important aspect of God's character, God was also just and would "*by no means clear the guilty*" (**Exod 34:7**). He is able to show mercy to some and remain a just God only because of the atoning death of Christ, as Paul has explained in **3:25–26**.

Steven Cole: There is only a slight difference, if any, between *mercy* and *compassion*. *Compassion* focuses on the feelings of sympathy for those in misery, while *mercy* is the action to relieve their misery. Both words point to the underlying fact that all have sinned and thus all deserve judgment.

James Stifler: Mercy is the outward manifestation of the feeling of compassion.

Thomas Schreiner: These words occur in a context in which Moses intercedes for Israel, which has turned aside in worshipping the golden calf. Moses asks Yahweh to show mercy, to forgive, and to continue to dwell with his people (**Exod. 32–34**). The Lord relents as a result of Moses's intercession, and then Moses prays to see God's glory (**33:18**), for in seeing God's goodness he will be assured that Yahweh will not withdraw his presence from his people. The words of **33:19** signify God's sovereign freedom in dispensing mercy, and in the context of Exodus they function as part of the revelation of God's name. The revelation of God's glory consists in "*all my goodness*," the proclamation of his "*name*," and the dispensing of his mercy as he sovereignly determines (**33:19**). The substance of **33:19** is unpacked further in **34:6**, where Yahweh reveals himself to be "*gracious and merciful*," although this does not mean that he refuses to punish the wicked (**34:7**). The theme of God's sovereign freedom has already been anticipated by the revelation of God's name in **3:14**. The citation of **33:19**, therefore, represents a principle because it **describes the very nature of God**, the way he characteristically acts—in sovereign freedom in showing mercy and also withholding it.

How does this constitute an answer to the objection that God is unrighteous? God is righteous because he is committed to proclaiming his name and advertising his glory by showing his goodness, grace, and mercy to people as he freely chooses. The righteousness of God is defended, then, by appealing to his freedom and sovereignty as the Creator (cf. **Murray** 1965: 25; **Käsemann** 1980: 267; **Hafemann** 1988: 46).

2. (:16) Mercy Does Not Depend on Man's Will or Performance

*"So then it does not depend on the man who wills or the man who runs,
but on God who has mercy."*

Thomas Schreiner: The reception of God's saving promises is not ascribed to human choice or activity. . . . Human works were excluded previously as the basis on which God elects and calls (**vv. 11–12**). **Verse 16** restates and clarifies this theme by indicating that human choice and effort are not the basis on which God's merciful promise is received. This verse excludes in the clearest possible terms the notion that free will is the fundamental factor in divine election (cf. **Müller**

1964: 80–81). The salvation of any, even of the Jewish remnant, is due to the mercy of God. Käsemann (1980: 267–68; cf. Müller 1964: 83–89; Stuhlmacher 1971: 558, 564) is on target in insisting that Paul’s doctrine of predestination is linked with his gospel of justification by faith.

Michael Bird: The currency that Paul gets from this [God’s interaction with Moses in **Ex. 33** following sin of **Ex. 32**] is to imply that Israel, when left to its own devices, becomes unfaithful and apostate, just as they were in the golden calf incident in **Exodus 32**, needing Moses to ask for himself to be blotted out of God’s book so Israel would be spared. It is but for the mercy of God that any person in Israel is able to endure.

Hence Paul’s explanation: “*It does not, therefore, depend on human desire or effort, but on God’s mercy*” (v. 16). This shows that Israel’s covenant relationship with God has nothing to do with whether Israel intends to do what God wants or whether Israel intends to run on the right track. God opted to stay with Israel even after the golden calf incident. In the end, as far as Israel is concerned, **divine justice is primarily a matter of mercy.**

John Toews: The critical issue in election is the purpose of God—to create a people that brings glory to the name—and the nature of God—merciful and compassionate.

C. (:17-18) Example of God’s Sovereign Dealings with Pharaoh

1. (:17) God Does What He Purposes

“For the Scripture says to Pharaoh, ‘For this very purpose I raised you up, to demonstrate My power in you, and that My name might be proclaimed throughout the whole earth.’”

David Thompson: Now in **Romans 9:17**, we get a look at two important reasons why God does not elect to give His mercy to everyone:

- 1) To demonstrate His power;
- 2) To spread a testimony of His sovereign power to the whole world.

Thomas Schreiner: Thus both mercy and hardening depend wholly on God’s will (v. 18), and the freedom of God is heralded in a most stunning way. God has acted in mercy and judgment for the sake of his name so that it will be sounded forth and proclaimed in the entire world. God shows his mercy and judgment in the same event: he shows his mercy to Israel by freeing them from Pharaoh’s grip, and he reveals his justice in judging Pharaoh.

John Toews: A second Scripture citation, **Exodus 9:16** in v. 17, further explains the righteousness of God. Pharaoh, who wished to destroy God’s people, is another example of God’s mercy. Pharaoh’s intent served God’s sovereign purpose of electing Israel. God demonstrated the divine, saving power of God (as in **1:16**) so that the divine name would be proclaimed in the world. The focus here is not on the judgment of Pharaoh, but on God’s mercy toward Israel. God saved Israel from Pharaoh and in the process demonstrated saving power. The commentary in v. 18 reaffirms that God is a God of mercy; God has mercy on whom God chooses, in this case Israel.

James Stifler: God's glory is promoted in the overthrow of a sinner as much as in saving one.

2. (:18) Mercy or Hardening Depend Only on God's Choice

*"So then He has mercy on whom He desires,
and He hardens whom He desires."*

Frank Thielman: The interplay in **Exodus 4–14** between God's initiative and Pharaoh's initiative is helpful in understanding what Paul meant when he said that God "hardens" certain people such as Pharaoh. Paul believed that God punished people for their own sin, not that God forced people to sin and then punished them for it. Otherwise, God would be acting nonsensically when he endured the rebellions of the wicked "*with much patience*" and stretched out his hands in appeal to disobedient Israel (**Rom 9:22; 10:21**). No patience is necessary for enduring the behavior of people doing what one wants them to do, and a lengthy appeal to people not to do what one has designed them to do is obviously fruitless.

When Paul says here, then, that God "*hardens*" people he must mean that God justly punishes people who, like Pharaoh (**Exod 8:15, 32; 9:34**) and everyone else (**Rom 1:18–3:20; 5:12–19**), are already in rebellion against him. God punishes them by calcifying this rebellion, or, to put it another way, **he further hardens resistant hearts**. This second level of resistance, which God himself initiates, is Paul's concern here, and it corresponds exactly to God's judgment in **1:24, 26, and 28** when he hands people over to their lust, dishonorable passion, and worthless thoughts.

Michael Bird: If we place this passage in the wider context of **9:6 – 10:21**, we see that the take-home point is that God's plan for Israel is deliverance, despite all that they faced, despite pagan kings, and even despite their own rebellion. God's purposes hold fast. Emphasized as well is that the single force that determines the future of Israel is not the whim of emperors, nor even the strength of Israel's own faith, but the mercy of God.

Steven Cole: I agree with **Wayne Grudem** (*Systematic Theology* [Zondervan], pp. 670, 684-686) that it is better to refer to God's foreordination of the wicked to judgment as *reprobation*, not *double predestination*, because the latter term implies that God carries out both election and damnation in the same way, which is not true. In predestining us to glory, God works directly on our hearts through His Spirit to impart new life, saving faith, and all the blessings of salvation. But in reprobation, God does not work immediately on the heart to infuse evil or force people to sin. Rather, He works through secondary causes to permit sin, so that sinners are justly condemned for their willful sins.

II. (:19-21) CAN MAN STILL BE HELD ACCOUNTABLE? ELECTION IS CONSISTENT WITH MAN'S RESPONSIBILITY

As God's creation, who are we to question God's inalienable right to shape us as he sees fit!

Thomas Schreiner: Paul retorts that frail and finite human beings should not arrogantly question God's justice and give him direction on how to run the world (**v. 20a**). God's sovereign rights are

defended with the illustration of the potter. God, like the potter, has sovereign rights to do what he wishes with his creation. It is unthinkable that the clay would protest against the potter (v. 20b). So too, God as the Creator has the right to make some vessels for honor (salvation) and others for dishonor (destruction, v. 21). Why has God made the world to function in this way? **Verses 22–23** provide the answer. God makes some vessels that are destined for destruction because he wants to reveal his wrath and power against sin. The revelation of his righteous wrath, however, is not his ultimate purpose. Against the backdrop of his wrath, the immeasurable richness and preciousness of his mercy is emblazoned on the consciousness of the vessels of mercy whom he has from the beginning prepared for glory.

Douglas Moo: Paul's reassertion of God's sovereignty in salvation (v. 18) sparks another round of question and answer (the diatribe style again). Paul's fictional sparring partner asks: "Then why does God still blame us? For who resists his will?" Paul again does not answer as we might expect. He offers no logical explanation of how God's determinative will and human responsibility cohere. Still less does he suggest that God's will is but his response to human decisions—as we would have expected him to say if, indeed, God's will to save were based on foreseen faith. No, rather than taking the defensive, Paul goes full speed ahead with yet further assertions of the freedom of God to do as he wants with his creatures.

A. (:19) Logical Question: Can Man Be Held Accountable

You will say to me then, 'Why does He still find fault? For who resists His will?'

Thomas Schreiner: If human beings cannot ultimately resist God's will, then how should we interpret Paul's response to the complaint in **verse 20**? I have already shown that he does not deny the premise: no one can ultimately resist God's will. What he denies is the conclusion: God therefore cannot find fault with human beings. In other words, Paul believes that God is absolutely sovereign and determines all things and at the same time posits that human beings are responsible for their choices and actions. We must observe that the objection doesn't represent a humble attempt to puzzle out the relationship between divine sovereignty and human freedom.⁷ The objection manifests a rebellious spirit that refuses to countenance a world in which God is absolutely sovereign and human beings are still responsible. The opponents dig in their feet by insisting that if God decides whom to harden and to whom to give mercy, then it is nonsense to hold human beings responsible for their actions.

Grant Osborne: Occasionally these questions are asked by those who are genuinely seeking to understand God and his ways with people. Usually, however, they are used to excuse certain behavior—"It's not my fault, God; it's your fault!" In either case, as Paul explains, the answer is the same. We ourselves are to blame because we are guilty of trying to reject or resist God. And even this questioning of God is an attempt to bring him down to our level. It is impossible for finite beings to totally understand an infinite God and how he works. We do know, however, that we have made choices to do what we know is wrong, to disobey God. Therefore, we are guilty. In fact, our consciousness of blame is practically an admission of blame. We ask why God blames us, while inside our consciences are blaming us. We may sincerely wonder just how much freedom we have to act within God's sovereignty, but there is little doubt that we use the freedom we do have to sin.

B. (:20-21) Answer from Creation

1. (:20) Creator Cannot Be Questioned

“On the contrary, who are you, O man, who answers back to God? The thing molded will not say to the molder, ‘Why did you make me like this,’ will it?”

Frank Thielman: The absurd image of a handmade object talking back to the artisan who made it comes from **Isaiah 29:16** and **45:9** where, as with Paul, the image portrays the folly of asserting one’s independence from God’s intentions for the unfolding of history. Beyond that general correspondence, however, Paul uses the image in his own way. The question, “*Why did you make me this way* [οὕτως]?” focuses attention on the function of the thing that the artisan has made and betrays the questioner’s dissatisfaction with the role God has assigned him or her. Since the questioner here represents Paul’s fictional portrayal of an unbelieving Jew, the question expresses dissatisfaction with the idea that God has freely hardened unbelieving Jews in their unbelief for his own purposes.

James Stifler: God is free to do as He will; He is a sovereign; and what is the idea of absolute sovereignty but that he who has it is under no obligation to give a reason for anything which He does? If He must give a reason for his actions He is no longer sovereign, but the reason given enjoys that distinction, not to say the persons to whom it must be given.

2. (:21) Creator Can Do What He Pleases

“Or does not the potter have a right over the clay, to make from the same lump one vessel for honorable use, and another for common use?”

III. (:22-23) WHY DOES GOD DELAY HIS WRATH? GOD’S PATIENCE MAGNIFIES HIS SELECTIVE MERCY

A. (:22) God’s Purpose for Vessels of Wrath

“What if God, although willing to demonstrate His wrath and to make His power known, endured with much patience vessels of wrath prepared for destruction?”

Michael Bird: While God’s choice remains mysterious, his dealings with Israel have always been marked by patience.

Frank Thielman: Moreover, the **passive voice** of the expression “*fitted out*” (κατηρτισμένα) is not insignificant. It stands in contrast to the active voice verb that Paul uses when he says that God “*prepared beforehand* [προητοίμασεν]” vessels of mercy for glory. God’s punishment of sinners is not as characteristic of his nature and identity as his mercy and grace to the sinful, and so the passive voice in the expression “*fitted out for destruction*” contains an element of reserve, ambiguity, and mystery that is appropriate to this element of God’s activity.

Thomas Schreiner: Since “*vessels of wrath*” (σκεύη ὀργῆς) refers to eschatological judgment and “*vessels of mercy*” (σκεύη ἐλέους) to eschatological glory, and since no evident adversative sense can be found between **verses 21** and **22–23**, it follows that the vessels for honor (τιμῆν, *timēn*) and dishonor (ἀτιμίαν, *atimian*) most naturally denote the saved and the perishing, respectively. The word τιμῆ (*timē*, *honor*) designates eternal life in **2:7**, **10**, where it parallels the

term δόξα (*glory*). The phrase ἐκ τοῦ αὐτοῦ φυράματος (*ek tou autou phyrματος*, from the same lump) recalls **9:11**, where the choice of Jacob over Esau was before birth and not based on any of their works (Piper 1993: 203; cf. Sanday and Headlam 1902: 260). Similarly, the choice of one for eschatological honor and the other for judgment from the same lump indicates that those chosen had no special merits or distinctiveness that accounted for their being chosen. Those who were chosen for salvation were selected on the basis of God's sovereign and free good pleasure.

B. (:23) God's Purpose for Vessels of Mercy

“And He did so in order that He might make known the riches of His glory upon vessels of mercy, which He prepared beforehand for glory,”

Thomas Schreiner: The mercy of God is set forth in clarity against the backdrop of his wrath. Thereby God displays the full range of his attributes: both his powerful wrath and the sunshine of his mercy. The mercy of God would not be impressed on the consciousness of human beings apart from the exercise of God's wrath, just as one delights more richly in the warmth, beauty, and tenderness of spring after one has experienced the cold blast of winter. As we have observed before in Romans, God's ultimate purpose is to display his glory to all people. His glory is exhibited through both wrath and mercy, but especially through mercy.

(:24) TRANSITION – INCLUSION OF THE CALLED GENTILES

“even us, whom He also called, not from among Jews only, but also from among Gentiles.”

Michael Bird: The switch from **v. 23** to **v. 24** is seamless, and yet there is a discernible **change in direction** as Paul mounts an intertextual argument to demonstrate the identity of the “*objects of mercy*,” the “*us*,” as consisting of Christ-believing Gentiles and Jews (**v. 24**). God's choice of Israel and the preservation of a remnant to be objects of his mercy and patience always had in mind a wider purpose to show mercy to Jews and Gentiles alike. God is not replacing Israel with the church. Instead, God is preserving a remnant within Israel and then expanding it to include Gentiles as well.

* * * * *

DEVOTIONAL QUESTIONS:

- 1) Under what circumstances are we tempted to think that God is unfair?
- 2) If Israel did not have a problem with God's sovereign choice of them as a nation, why should they wrestle with the doctrine of election when it comes to individuals?
- 3) How does God's patience mesh with His mercy, compassion and wrath?
- 4) How do you apply the potter and clay analogy to your own relationship with the Lord?

* * * * *

QUOTES FOR REFLECTION:

John Toews: It is important to note that the question of God's justice for Paul is quite different from modern concerns about **theodicy**. Modern theodicy focuses primarily on the unjust suffering of innocent people. Paul believes that all human beings are sinners who deserve judgment (**3:9, 10, 19**). His question is, why does a righteous God leave sinners unpunished? Paul's answer is the mercy of God. God restrains judging human sin because of divine mercy, because of a desire to see all humans redeemed (**3:25**). Pharaoh and Israel should have been destroyed, but God exercised mercy and used both to achieve a larger divine purpose. God is righteous because God is merciful, because God causes even evil to work for good. And because God is just, God is free to elect. . .

God's Election Purposes a New People (9:22-29) --

Verses 22-23 constitute one long question. The question begins a new paragraph, *but what if God wishing to demonstrate his wrath and to make known his power ...* (most translations do not translate the but). Paul is making a new point, his first distinctively Christian argument so far in **chs. 9-11**.

The question asks the readers to consider a possible way to understand God's purpose. What if the Creator God, who wishes to exercise end-time judgment (*show his wrath*) and thus demonstrate divine power, has tempered deserved judgment with patience. Evil, here the rebellion of the creature against the Creator, deserves God's judgment. The objects of the judgment are *vessels of wrath made for destruction*. In the context these vessels would be Esau and Pharaoh. What if God withholds judgment *in order to make known the riches of his glory for the vessels of mercy, which he prepared before hand for glory?* In the context, and in Jewish theology, the vessels of mercy would be Israel. While the Jewish Christians in Paul's audience would be nervous about postponing divine judgment on enemies like Pharaoh, they would certainly affirm their election, and God's intention to make known the riches of divine glory through them. The question plays directly into Jewish national theology.

In **v. 24** Paul turns the tables. More accurately, he drops a **fragmentation bomb**. The *vessels of mercy* are not the Jews, but *us whom God has called not only out of the Jews but also out of the Gentiles*. The bomb fragments fly in many different directions. This new people is *called*, one of the main thematic emphases in the argument of **9:6ff**. Second, the composition of this new people is defined by the familiar *Jew/Gentile* phrase from earlier in the letter (**1:16; 2:9, 10; 3:9**) and the *not only/but also* argument of **3:29** and **4:12, 16**. Third, the nature of this new people is in fulfillment of Israel's Scripture. God's calling this new people is a demonstration that the word of God has not failed. Fourth, just as the *vessels of mercy* are redefined, so also the *vessels of wrath* are redefined. The *vessels of wrath* are now suddenly unbelieving Jews, rather than Esau and Pharaoh.

Verse 24 rearranges the preceding argument. **Verses 22-23** are suddenly parallel with **v. 17**. **Verses 14-18** illustrated the impartiality of God. God makes equal use of *vessels of mercy* and *vessels of wrath*. Moses was an example of mercy and Pharaoh of wrath. God did not liquidate

Pharaoh, but used him to demonstrate divine power and to proclaim the divine name in all the earth. The same is happening again, only now Israel represents the vessels of wrath. And again, God is not destroying Israel but using her unbelief to demonstrate divine wrath and to proclaim glory to all the nations. The point that the concentration of wrath in one people serves the purposes of God builds on Paul's earlier suggestion that God called Israel to be the people where Sin would be focused so that it could be condemned and defeated in one place by one person (5:20; 7:13-8:2).

The radically new element that changes everything is the **inclusion of the Gentiles**. Paul has not excluded the Jews; that issue does not arise until 9:30f. and is not explicitly asked until 11:1. Paul simply redefines God's people by including believing Gentiles. God's merciful calling of Gentiles is no different than God's merciful call of Israel.

Paul's astounding claim requires biblical proof, which is supplied in vv. 25-29 in a **chiasm** that builds on v. 24:

- A v. 24a Jews
- B v. 24b Gentiles
- B vv. 25-26 Gentiles
- A vv. 27-29 Jews

John MacArthur: And so, Israel's unbelief must be dealt with. And it is in **chapter 9**.

- The unbelief of Israel is not inconsistent, says Paul in this chapter, with God's promise, that's **verses 6 to 13**;
- it is not inconsistent with God's person, **verses 14 to 24**;
- it is not inconsistent with God's prophets, **verses 25 to 29**;
- and it is not inconsistent with God's prerequisite, **verses 30 to 33**.

Chapter 9 then is in a sense defending God against the accusation of unfairness, violated promises, loss of integrity, violated prophecies and having changed His rules in midstream. So Paul writes chapter 9 to demonstrate that even though Israel is in unbelief, and even though Israel rejects the Messiah and even though Israel is set aside, this in no way violates God's promise, God's person, God's prophets, or God's prerequisite. . .

"Shall the thing formed say to him that formed it, Why hast thou made me thus?" The contrast here, underline it in your Bible, is Man/God. O man, who art thou that repliest against God? You with your little infinitesimal, puny, pusillanimous, pea-brain, who are you to stand up and say, "Well, God, this doesn't seem fair."? Who are you with your little tiny thimbleful of information against the vastness of an eternal mind as big as the endless universe? Who are you that answereth God? Just because you can't figure it out and it appears to you to be unfair, who are you to reply against God with such blasphemy to accuse God of being unrighteous and unfair? Close your mouth. Close your mouth and realize that you know very little, very little. And if you don't understand how this is resolved in the mind of our compassionate, merciful, loving and gracious God, then it isn't that God's character should be mistrusted, it is that you don't have enough information. And if you want to know the truth, the information is beyond your ability to comprehend and that's why you don't get it, because there are hopeless, hopeless antinomies in Scripture that could never be resolved in the human mind.

Grant Osborne: Stages in the Hardening Process

<i>Stage 1</i> Abandoning God's guidance from his Word or believers	<i>Example</i> "I don't read the Bible or attend church." "Who are they to tell me what to do?"
<i>Stage 2</i> Willfully disobeying God based on desire for sin or unresolved conflict with God	"I know it's wrong, but I want it." "Where was God when I needed him?" "How could he do this to me?"
<i>Stage 3</i> Justifying sin as not really being sin, but as being essential for the person's welfare	"I'm not sure this is really wrong." "I'm not as bad as others." "I'll feel better."
<i>Stage 4</i> Rejecting the Holy Spirit's conviction	"I know I'll feel guilty, but I don't care." "I'll just ignore it."
<i>Stage 5</i> Becoming entrenched in the sinful behavior	"I'm in too deep to get out." "I might as well finish what I started."

David Thompson: What is the **value** of knowing this doctrine?

1. You may be absolutely certain God's Word and purposes have never failed.
2. You may have an understanding of why some people fall away from the faith.
3. You may truly grasp the fact that salvation can only be by God's grace.
4. You will glorify God because you exalt Him and not man.
5. A believer is able to bow before God, humbled and thankful for the fact that God chose him/her.

Leedy Greek NT Diagrams:

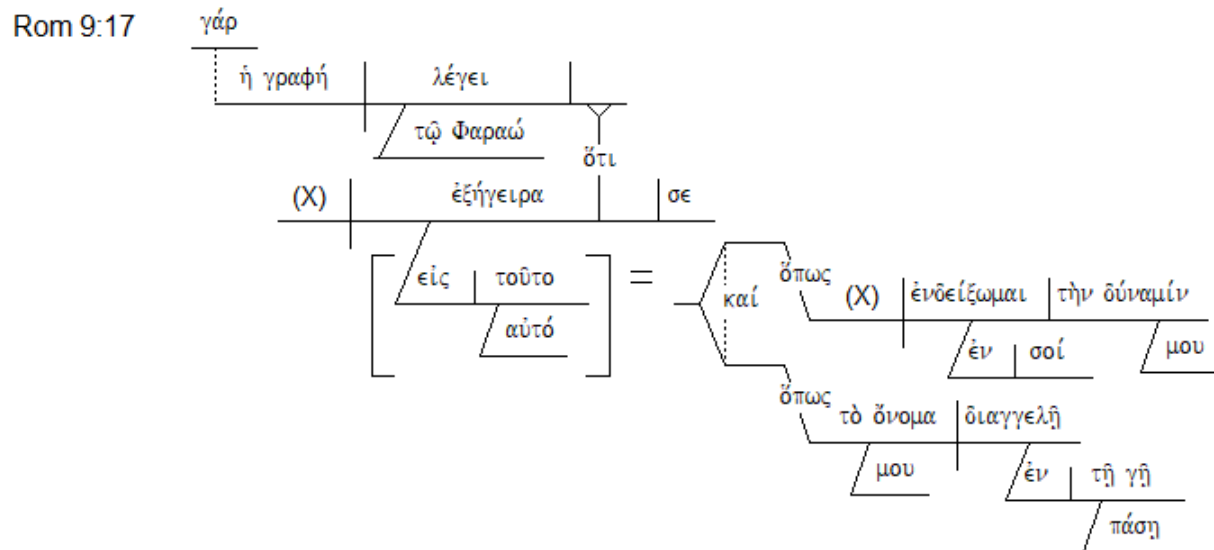
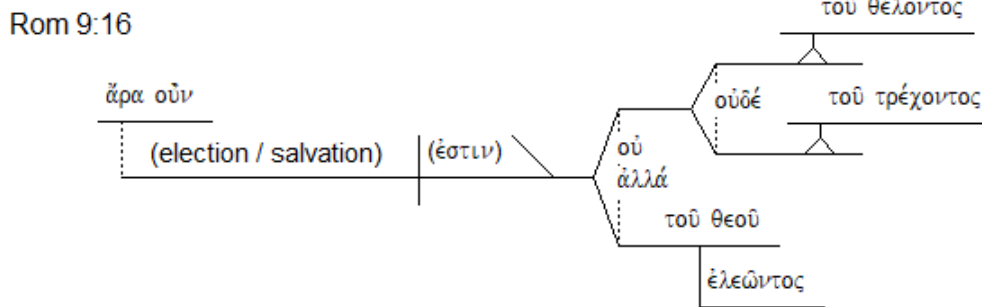
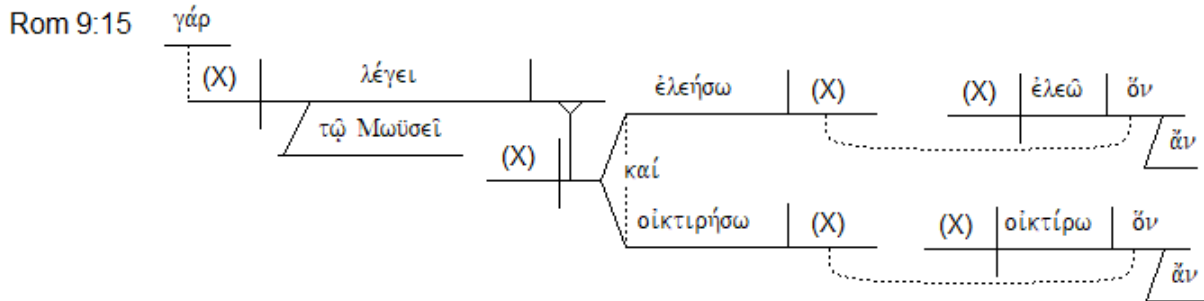
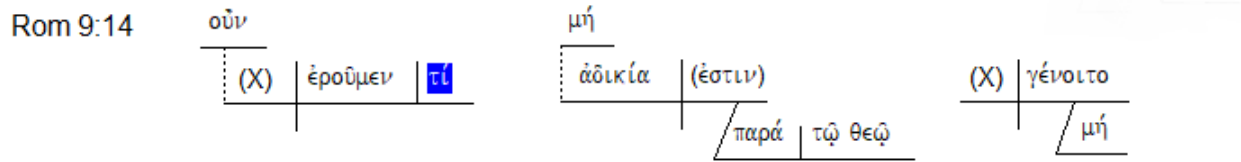

Rom 9:18

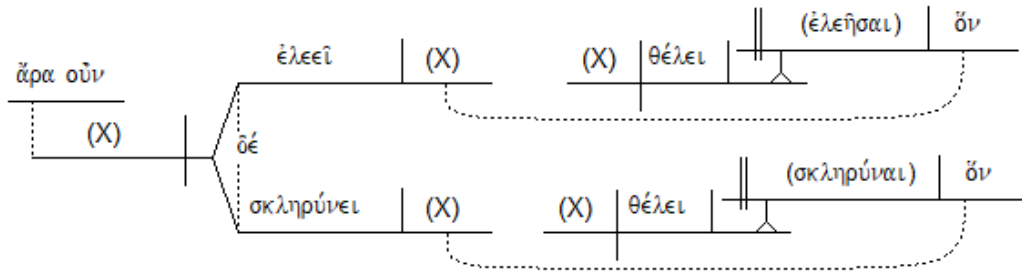

Rom 9:19

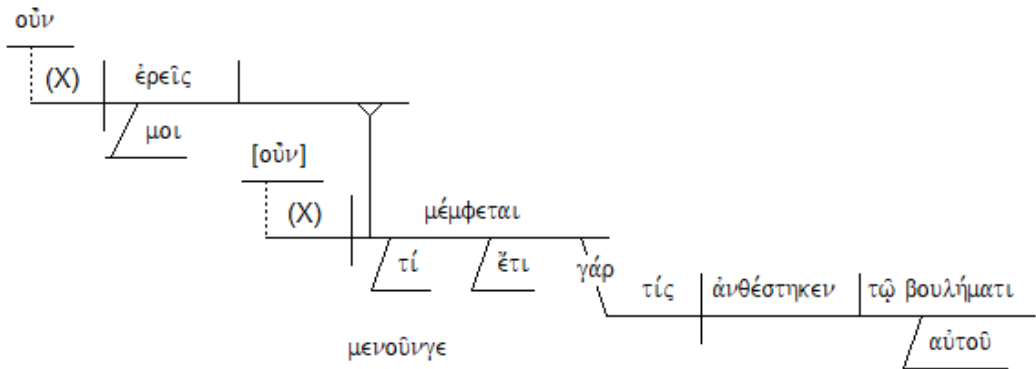

Rom 9:20

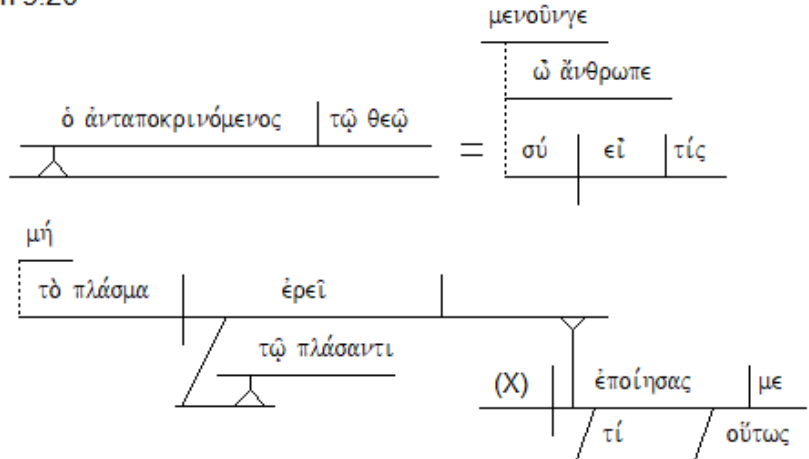

Rom 9:21

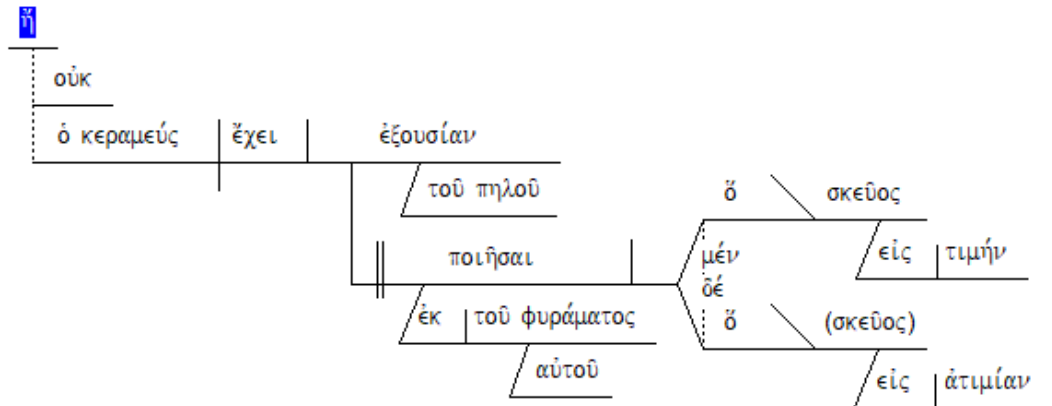

Rom 9:22-26

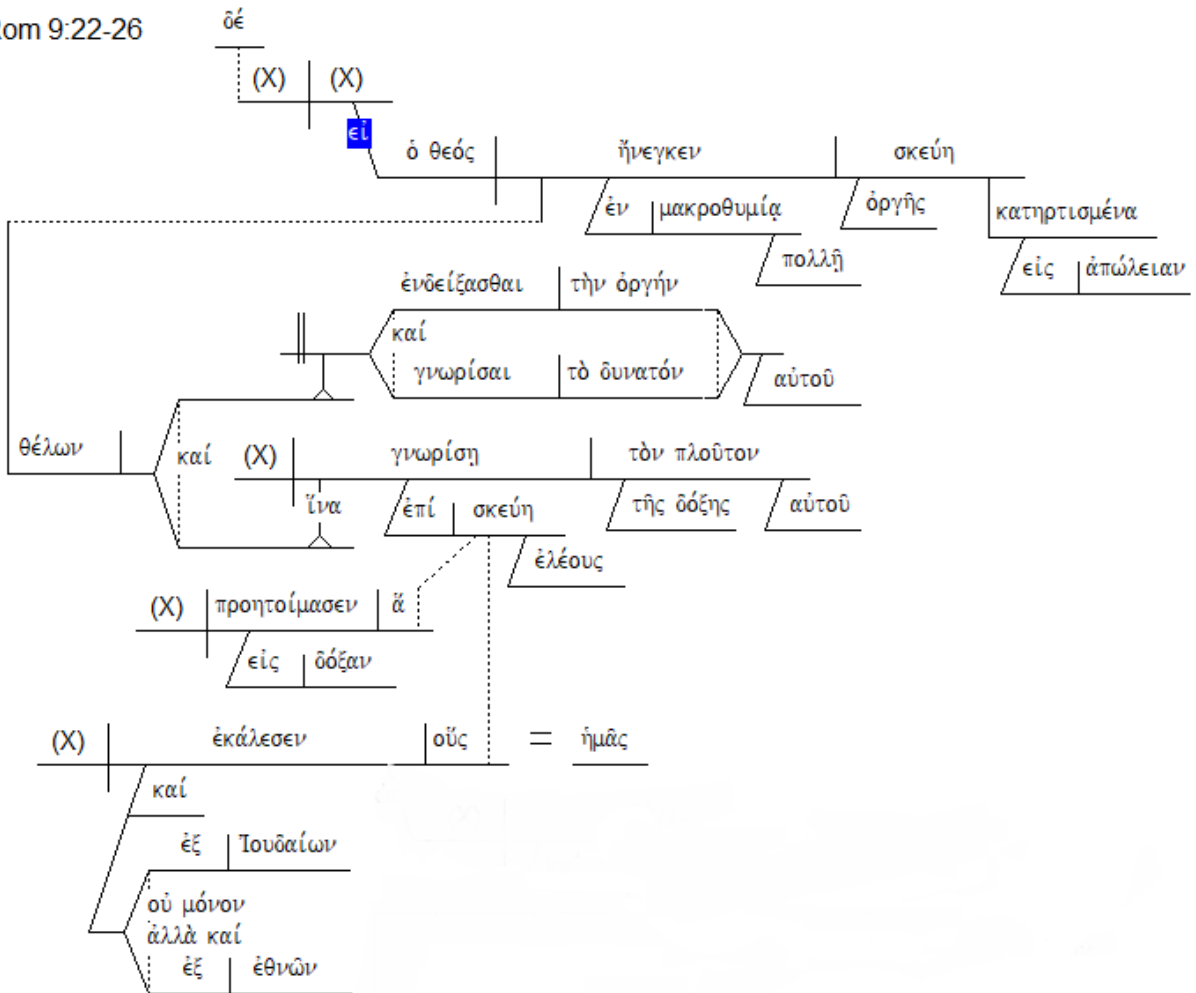

Frank Thielman:

- 14a (False) Inference Assertion **What, then, shall we say? There is no injustice with God is there?**
- b Exclamation **Certainly not!**
- 15 Basis For **to Moses he says,**
 "I show mercy to whomever I show mercy, and I will show compassion to whomever I show compassion." (Exod 33:19)
- 16 Inference (from 15) So then, it is **not of the one who wills, nor of the one who runs, but of God who shows mercy.**
- 17 Verification (of 16) For **the Scripture says** to Pharaoh,
 "For this very purpose I raised you up: that I might show my power in you and that my name might be proclaimed in all the earth." (Exod 9:16)
- 18 Inference (from 17) So then, **he shows mercy to whom he wills, and he hardens whom he wills.**
- 19 (False) Inference **You will say to me, then,**
 "Why does he still assign blame? For who withstands what he plans?"
- 20a Contrast To the contrary, you mere human being,
- Rhetorical Question **who are you to answer back to God?**
- b Rhetorical Question **Will the thing formed say to the one who formed it, "Why did you make me this way?"**
- 21 Illustration/ Rhetorical Question Or **does the potter not have authority**
 over the clay
 to make from the same lump
 one vessel for the purpose of receiving honor and
 one for the purpose of receiving dishonor?
- 22a Rhetorical Question/ And **what if God endured**
 Explanation
- b Manner with much patience
- c Object vessels of wrath fitted out for destruction
- d Cause (of 22a, c) because he wanted to show his wrath and
- e Cause (of 22a, c) to make known his power, and

23 Cause (of 22a, c)

in order that he might make known the wealth

of his glory
 toward vessels of mercy
 which he prepared beforehand for glory,

24a Explanation (of 23)

us
 whom he also called

b

not only from the Jews but also
 from the gentiles?

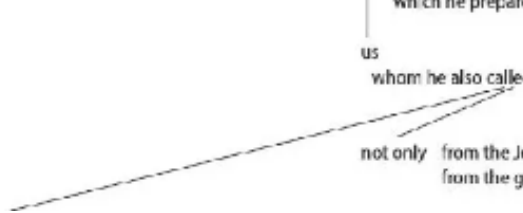

TEXT: ROMANS 9:24-33

TITLE: GENTILES GRAFTED IN . . . JEWS RESTRICTED TO SMALL REMNANT

BIG IDEA:

AS THE OT PROPHETS PROMISED, GOD HAS CHOSEN TO SOVEREIGNLY SAVE MANY GENTILES THROUGH FAITH IN CHRIST BUT ONLY A REMNANT OF JEWS IN THIS AGE

INTRODUCTION:

Thomas Schreiner: Even though **verse 24** advances the argument in a new direction, we should not fail to see the connection with what Paul said in the previous paragraph. In **verses 22–23** he has stressed that God’s mercy is appreciated and perceived as mercy when it is displayed against the backdrop of wrath. What **verse 24** highlights is the calling of the gentiles to faith: God “*called not only the Jews but also the gentiles.*” The inclusion of the Jews in the people of God is not surprising, since such is clearly taught in the OT Scriptures. What is astonishing is that gentiles are also recipients of God’s mercy. The inclusion of the gentiles fits nicely with the theme articulated in **verses 22–23**. To the Jews of Paul’s day, gentiles were particularly deserving of God’s wrath. Thus their calling into the church through Paul’s ministry highlights God’s mercy in a way that the inclusion of the Jews does not. This is not to say that the inclusion of the Jews does not exhibit God’s mercy. Indeed, as Paul’s argument in **Rom. 9–11** develops, he will explain how history is structured in such a way that the calling of both Jews and gentiles at particular junctures of history is designed to maximize the display of God’s mercy.

In this paragraph Paul features the inclusion of many gentiles into the people of God, while only a remnant of Jews are being saved. Paul has explained that such is God’s purpose and intention. The paragraph comes to an end with the salvation of a Jewish remnant. On the one hand, the sin of Israel is featured, but on the other hand, the presence of a remnant spells hope: God isn’t finished with Israel yet. . .

What is striking is that God is calling only a remnant from Israel, whereas large numbers of gentiles are streaming into the church. This is utterly astonishing, since the Jews would have expected it to be precisely the opposite. Some gentiles would be recipients of God’s mercy, while the vast majority of the Jews would be the objects of his gracious call. What Paul shows with these OT citations is that this reversal is not as novel as one might think. The OT itself prepares us for the idea that God would show mercy to those who were least expected to receive it and would save only a remnant from Israel. It should also be noted that the thesis of **verse 6a** continues to be developed. God’s word has not been frustrated through the disbelief of the majority of the Jews. He planned that only a remnant of Jews would believe and that many gentiles would confess Jesus as Messiah in order to maximize his mercy (cf. **11:32**). Still, the existence of a Jewish remnant signifies that there is **hope for Israel’s future**.

James Stifler: The substance of the chapter is that, in spite of Israel’s rejection, in spite of the present mixed following of Jews and Gentiles as the Lord’s people, God’s Word has not failed,

for God never pledged away his sovereignty in it, but, on the other hand, predicted that salvation turned on His will and call.

Warren Wiersbe: So far, Paul had defended the character of God by showing His faithfulness, His righteousness, and His justice. Israel's rejection had not canceled God's election; it had only proved that He was true to His character and His purposes. . .

No one will deny that there are many mysteries connected with divine sovereignty and human responsibility. Nowhere does God ask us to choose between these two truths, because they both come from God and are a part of God's plan. They do not compete; they cooperate. The fact that we cannot fully understand how they work together does not deny the fact that they do. When a man asked **Charles Spurgeon** how he reconciled divine sovereignty and human responsibility, **Spurgeon** replied: "I never try to reconcile friends!"

John MacArthur: Now as Paul presents the gospel, the question is posed to him, how can it be true if God's chosen people the Jews don't believe it? How can it be genuinely from God if the people of God reject it? That's the issue. If this new truth is really of God, then why don't God's people receive it? Paul must answer that and that is the reason he writes **chapters 9 through 11**. And it's essentially tied to his doctrine of justification by grace through faith in the person and work of Jesus Christ. He wants people to believe that salvation comes through Jesus Christ. The Jews say, no it doesn't. How can it be true when the Jews, God's people, reject it? That's the question. . .

The unbelief of the Jews does not violate God's plan. Some are going to say, "Well now wait a minute, I mean, God had a plan for Israel, God had an everlasting plan for Israel, God promised them that they would be as the sand of the sea and they would enter into blessing and prosperity, God promised them a kingdom, God promised them life. I mean, now all of a sudden they're in unbelief, this violates God's plan." I mean, the Jew is going to say, "You can't preach this new gospel, it just violates God's plan. I mean, it means that all the Old Testament prophets were wrong when they promised things to Israel, when they predicted a kingdom."

(:24) TRANSITION – INCLUSION OF THE CALLED GENTILES

*“even us, whom He also called, not from among Jews only,
but also from among Gentiles.”*

Michael Bird: The switch from **v. 23** to **v. 24** is seamless, and yet there is a discernible **change in direction** as Paul mounts an intertextual argument to demonstrate the identity of the “*objects of mercy*,” the “*us*,” as consisting of Christ-believing Gentiles and Jews (**v. 24**). God's choice of Israel and the preservation of a remnant to be objects of His mercy and patience always had in mind a wider purpose to show mercy to Jews and Gentiles alike. God is not replacing Israel with the church. Instead, God is preserving a remnant within Israel and then expanding it to include Gentiles as well.

I. (:25-26) SALVATION EXTENDED TO MANY GENTILES (Quote from Hosea)

“As He says also in Hosea,”

S. Lewis Johnson: Paul follows with a series of Old Testament quotations in support of the fact that God has called Gentiles to faith and left Israel with a remnant in the earth. In other words if Israel had read the Scriptures, they would have understood what might happen, if they should reject the revelation of God climaxed in the appearance of their Messiah, the Lord Jesus Christ (cf. **Ro 9:25-29**). Oh! How many things become clear when we read the Scriptures! (**Romans 9:14-33**)

A. (:25) Incorporation of Gentiles as God’s Beloved People

1. God’s People

“I will call those who were not My people, ‘My people,’”

2. God’s Beloved

“And her who was not beloved, ‘beloved.’”

God has chosen to include many Gentiles who had no previous ancestral relationship to God.

Frank Thielman: God’s word in Hosea confirms the surprisingly multiethnic nature of God’s people. Just as in Hosea’s time God mercifully accepted an idolatrous and unjust Israel again as his people, so now he has turned gentiles into recipients of his mercy. In both cases, those who were not his people because of their rebellion against him have become his people. . .

The first part of Paul’s quotation is an altered form of **Hosea 2:23** (2:25 LXX), and the second part of his quotation comes word for word from **Hosea 1:10** (2:1 LXX). Paul’s alterations of **Hosea 2:23** (2:25 LXX and Heb.) are significant. He reverses Hosea’s two clauses and changes their wording to fit the themes he has developed in **Romans 9:6–25**. Hosea’s *“I will say [ἐρῶ]”* becomes *“I will call [καλέσω]”* to match the statement that God *“called”* (ἐκάλεσεν) vessels of mercy from among both Jews and gentiles in **Romans 9:24** (cf. **9:7, 12**). This change also allows Paul to form an inclusion with the verb *“they will be called”* (κληθήσονται) from **Hosea 1:10** (2:1 LXX), which he uses in the second part of his quotation. In addition, Paul changes Hosea’s *“I will have pity on Not Pitied”* to *“[I will call] ‘Not Loved’ ‘Loved’ [ἡγαπημένην ἡγαπημένην],”* and this echoes the line, *“Jacob I have loved [ἡγάπησα]”* from **9:13**.

These changes highlight the twofold theme that

- (1) God has the right to show mercy to whomever he will and that
- (2) God’s choice of those to whom he will show mercy is often surprising from a human perspective. In this case, the surprise is that those who have received God’s mercy are *“not only . . . Jews but also . . . gentiles”* (9:24).

Thomas Schreiner: God mercifully calls both Jews and gentiles as his people. God’s call isn’t merely an invitation but is an effectual call, demonstrating that God in his mercy and grace chose some from among both Jews and gentiles for salvation. The calling of gentiles especially features the riches of God’s grace, since they were outside the circle of his covenant love.

William Hendriksen: How is it possible for Paul and Peter to take a passage which predicts restoration for *Israelites* and apply it to audiences in which *Gentiles* predominated?

The answer is simple: the same principle operates throughout. . . . That which brings about the restoration or conversion is ever the active, powerful, and sovereign grace of God Almighty! What is stressed in these quotations is the sovereign and pitying grace of God shown to those who – whether Jews or Gentiles – lack the right to consider themselves God’s people.

F. F. Bruce: What Paul does here is to take this promise, which referred to a situation within the frontiers of the chosen people, and extract from it a principle of divine action which in his day was reproducing itself on a world-wide scale. In large measure through Paul’s own apostolic ministry, great numbers of Gentiles, who had never been “*the people of God*” and had no claim on His covenant mercy, were coming to be enrolled among His people and to be the recipients of His mercy. The scale of the divine action was far wider than in in Hosea’s day, but the same pattern and principle were recognizable. Through the Gentile mission, in those lands where the people of God had once been unrepresented, there were now many believers who were acknowledged as “*sons of the living God*”.

John MacArthur: So please note that the use of Hosea's prophecies is not particularly to emphasize Israel's restoration, though that appears in the prophecies that He'll call them back to be His people, His beloved sons of the living God. The particular point in using the prophecies is to show that a future restoration of Israel **demands a falling of Israel**, right? You don't have to restore what hasn't been lost. And the point is that Paul is saying **we're not shocked by Israel's unbelief**, quite the contrary. **We expected it** because God promised their restoration from that unbelief. So when you look at the gospel being presented and you ask yourself the question as I have been asked by Jewish people, if your gospel is true, why didn't the Jews believe it? I say it was planned in the prophecy...in the plan of God that the Jews would have to be restored from unbelief so **we're not surprised they've entered into unbelief from which they'll be restored**.

B. (:26) Incorporation of Gentiles into Family of God

“And it shall be that in the place where it was said to them, ‘you are not My people,’ There they shall be called sons of the living God.”

Everett Harrison: It is just possible that Paul does not intend the second passage (**Hos 1:10**) to apply to Gentiles (though this is by no means certain), in which case by the sequence of the passages he may be giving a hint of something developed in **chapter 11** – namely, the influx of Gentiles during Israel’s temporary rejection, to be followed by the turning of Israel to the Lord in great numbers (**11:25-27**).

II. (:27-29) SALVATION RESTRICTED TO SMALL JEWISH REMNANT (Quote from Isaiah)

“And Isaiah cries out concerning Israel,”

John Walvoord: The passages quoted (**Isa. 10:22-23** and **1:9**, both from the LXX) make it clear that in God's judgment on rebellious Israel He by sovereign choice preserves and saves a remnant. Those promises were fulfilled in the Captivity and Exile of both Israel and Judah and in the destruction of Jerusalem in a.d. 70 and will also be fulfilled in the national end-time deliverance of Israel. Even today the same principle is true. Jews who become members of the church, the body of Christ, are what Paul later called "*a remnant chosen by grace*" [*Bible Knowledge Commentary*].

A. (:27) Expectation of Salvation of Only a Small Remnant

"Though the number of the sons of Israel be as the sand of the sea, it is the remnant that will be saved;"

Thomas Schreiner: The salvation of only a remnant among the chosen people continues to advance the theme of mercy against the backdrop of wrath. When one sees that the majority of Israel are vessels of wrath, then the mercy vouchsafed to the remnant is all the more striking. The selection of a remnant also impresses on the reader the freedom of God as he works in unexpected ways.

Douglas Moo: **Isaiah 10:22–23**, quoted in part in **Romans 9:27–28**, is one of the great "remnant" texts in the Old Testament. The remnant conception emerged in the prophets as a message of both **judgment** and **hope**—judgment, because the continuing sinfulness of Israel brought God's judgment on the people as a whole, resulting in the salvation of only some of the people; hope, because despite Israel's sinfulness, God maintained his commitment to his covenant and pledged to save at least some of the people.

John MacArthur: So the events of Jewish history monitored by Hosea and monitored by Isaiah are pictures, prophetic pictures of the events about the time of Jesus Christ and the presenting of the gospel and the age in which we live when the Jews have also rejected God and been severed from Him, scattered. There were only a few, by the way, who were saved out of the Assyrian conquest, just a few. And they sort of typify the few who are saved in this age.

B. (:28) Expectation of Decisive Judgment

"for the Lord will execute His word upon the earth, thoroughly and quickly."

Frank Thielman: On the positive side, God will save his people from destruction, but on the negative side, only a remnant of them will be saved. In the original context the destruction would come from the Assyrians, who would sweep into Israel from the north as God's tool of judgment on his sinful people. God would nevertheless leave a remnant within Israel both to humble the Assyrians and to provide for the eventual fulfillment of his promise to Abraham to "*multiply*" his "*offspring . . . as the sand that is on the seashore*" (**Gen 22:17**).

C. (:29) Expectation of Almost Being Completely Devastated

"And just as Isaiah foretold, 'Except the Lord of Sabaoth had left to us a posterity, we would have become as Sodom, and would have resembled Gomorrah.'"

III. (:30-33) ISRAEL STUMBLER OVER SALVATION BY FAITH IN CHRIST

A. (:30-31) Contrast between Pursuit of the Gentiles and the Jews

1. (:30) Pursuit of the Gentiles = Righteousness by Faith

“What shall we say then? That Gentiles, who did not pursue righteousness, attained righteousness, even the righteousness which is by faith;”

Thomas Schreiner: From this section we learn that Paul viewed divine sovereignty and human responsibility as complementary rather than contradictory truths. They are not mutually exclusive but are compatible. Paul provides no philosophical resolution as to how they correlate, and it is probably best to acknowledge that they relate mysteriously, in a way that exceeds our finite understanding. In any case, it would be a serious mistake to appeal to divine sovereignty as if it diminished the genuineness of human freedom and responsibility.

2. (:31) Pursuit of the Jews = Self-Righteousness

“but Israel, pursuing a law of righteousness, did not arrive at that law.”

Douglas Moo: Paul’s formulation “” is probably an attempt to make two points at once: Israel pursued righteousness, but she did *law of righteousness* not obtain it because she elevated *nomos* to the central position of concern. The people of Israel, therefore, focused narrowly on the works the law demanded and missed the larger demand of God to submit to him in faith. Thus they failed to obtain righteousness.

Paul explains this basic problem again in 9:32b–33, but in different terms. He draws the picture of a walker so intent on pursuing a certain goal that she stumbles and falls over a rock lying right in her path. So Israel, myopically concentrating on the law and its demands, missed Christ, “*the stone*” that God placed in her path. This imagery comes from **Isaiah 8:14** and **28:16**, which Paul quotes in **Romans 9:33**. These texts, along with another “*stone*” text (**Ps. 118:22**), are quoted together in **1 Peter 2:6–8**, suggesting that they may have been brought together via the key word “*stone*” by Christians before Paul’s day.

B. (:32a) Core Distinction = Faith vs. Works

“Why? Because they did not pursue it by faith, but as though it were by works.”

Everett Harrison: Gentile success is attributed to their avoidance of the false approach of the Jew and their willingness to receive righteousness as a **gift**. Hardly a passage in the NT is stronger than this one in its exposure of the **futility of works** as a means of justification.

John Witmer: The Israelites did not admit their inability to keep the Law perfectly and turn by faith to God for forgiveness. Instead a few of them kept trying to keep the Law by their own efforts. Consequently they stumbled (cf. **Rom. 11:11**) over the “*stumbling stone*.” The Lord Jesus Christ, “*the stumbling Stone*” (cf. **1 Peter 2:4-8**), did not conform to the Jews’ expectations, so they rejected Him instead of responding to him by faith.

John MacArthur: greatest obstacle to salvation is **self-righteousness**. You understand that? Because you can't get saved if you don't know you need it, right? And that's what hung up the Jews. They thought they were already righteous. You see, they had spent their whole life

pursuing a right relationship with God through their own efforts. So when the gospel came and condemned their sin, it did not compute because they thought themselves righteous. So the Jews rejected, except for a small remnant, small remnant. . .

We are **justified by faith**. And there's the human response. The Gentile got it not because he was elect, but because **he believed**. That's the balance of human responsibility.

Verse 31: "*But Israel, who followed after the law of righteousness.*" Stop there. Did they do that? O man, did they ever. I mean, they pursued... The word "law" means principle, or standard. They pursued the principle of righteousness. I mean, it was a way of life, we must be righteous, we must be righteous, we've got to do this and not do that and do this and not do that. And they had all this myriad of prescriptions pursuing the principle of righteousness, pursuing the standard of righteousness incessantly as a way of life they did that. And they did it all by what? By works. Proud-hearted legalists pursuing **self-righteously** a right relationship to God and it says they went after the law of righteousness and they did not attain it. They didn't get it.

You say, "They weren't elect, weren't chosen." It's not what it says. You say, "Why didn't they get it?" **Verse 32**, that's what Paul says, why? Why didn't they get it? Because they sought it not by what? "*By faith.*" That simple. There is salvation by seeking, beloved, but seeking with faith, not pursuing by works. I'm going to get better, I'm going to do better, I'm going to act better, I'm going to think better, I'm going to talk better and God will like me better and then I'll be okay with Him. No, it's saying...kind of goes like this, the only thing that you can do to be saved is to believe that you can do nothing to be saved and cast yourself on the mercy of God. Did you get that? The only thing you can do to be saved is to believe you can do nothing to be saved and cast yourself on the mercy of God.

Some of the Gentiles did that, great numbers of them. A few Jews did. But Israel, who all their life had pursued a standard of righteousness, never got it because they sought it not by faith. But it says, as it were, "*by the works of the law.*" They tried to get it by law keeping, by their own abilities. In fact, a gracious, merciful salvation given as a free gift was an offense to a self-righteous Jew, because it said none of your works matter, none of your works count and he couldn't handle that. That's why they rejected Jesus with such anger, such bitterness, such hatred because they were so offended that all their life long of all these righteous deeds added up to what? Zero. Whew...and now when they looked at the cross and they were told this man is dying for your sins, the cross was to them what? **First Corinthians 1**, foolishness, foolishness, it offended them, it offended them.

C. (:32b-33) Christ = Stumbling Stone for the Jews

*"They stumbled over the stumbling stone,
just as it is written,
'Behold, I lay in Zion a stone of stumbling and a rock of offense,
and he who believes in Him will not be disappointed.'"*

A. Berkeley Mickelsen: "*And the one trusting in him will not be disappointed*" – introduces a ray of light into an otherwise dark picture. Such a positive response, however, was not that of Israel as a whole, for Israel stumbled at the stone that God placed in Zion.

* * * * *

DEVOTIONAL QUESTIONS:

- 1) Why did the Jews have a hard time believing that only a small remnant of their countrymen would be saved in this present age?
- 2) Where do you see self-righteousness and reliance on works in your own life?
- 3) How could Paul apply OT passages to the Gentiles that clearly in their original context spoke to the situation of the Jewish people?
- 4) Why is the foolishness of the cross such a stumbling stone for most Jews today?

* * * * *

QUOTES FOR REFLECTION:

Thomas Schreiner: The inclusion of the gentiles fulfills the prophecy that God would provoke Israel to jealousy by another nation and that he would reveal himself to those who did not seek him. Nonetheless, God continues to stretch out his hands to Israel, imploring them to be saved. Still Israel obstinately resists God's gracious advances. By citing these OT prophecies, Paul reveals that it was always God's plan to provoke Israel to jealousy by including gentiles within the realm of his blessing. The events of history are not surprising to God.

Steven Cole: In our text [:30-33], Paul lays out the right and wrong ways to come to God. To state the wrong way first:

To approach God through our works will cause us to stumble over Christ and be lost; to approach God through faith in Christ results in righteousness and salvation.

The contrast is plain and stark: If we pursue the righteousness that we need to stand before God by our works we will fail. If we come to God by faith in Christ, we attain righteousness, even if we were not previously pursuing it.

Before we examine both halves of this contrast in more detail, let me point out that there is an inherent danger for those of us who were raised in a Christian home. It is a great advantage to be raised in a Christian home, in that you learn about God and the way of salvation as a child. You're often spared from the destructive scars of sin that those in the world have experienced. But the danger is that you may trust in your own religiosity and morality, while you resent or despise those who are not so religious or moral. You become like the older brother in the parable of the prodigal son: "I've served you for years and always obeyed you, but then you lavish your love on this no-good brother of mine! But what have you ever done for me?" (See **Luke 15:28-30**.) And so you miss the heart of the gospel, which is God's grace.

1. To approach God through our works is built on faith in ourselves and will cause us to stumble over Christ and be lost (9:31-33).

Scholars spill a lot of ink debating what Paul means by “*a law of righteousness*” (9:31), but it probably refers to the Law of Moses that Israel pursued to try to attain righteousness before God. But Israel failed to attain that righteousness because they did not pursue the law by faith, but as if it could be attained by works. In so doing, they were only seeking to establish their own righteousness (10:3), which always falls short. This wrong approach caused them to stumble over the stumbling stone, which is Christ.

A. TO APPROACH GOD THROUGH OUR WORKS IS FUNDAMENTALLY FLAWED BECAUSE IT IS BUILT ON FAITH IN OUR SINFUL SELVES.

B. TO APPROACH GOD THROUGH OUR GOOD WORKS WILL CAUSE US TO STUMBLE OVER CHRIST.

2. To approach God through faith in Christ results in perfect righteousness and salvation.

A. WE NEED A PERFECT RIGHTEOUSNESS WHICH ONLY COMES THROUGH FAITH IN JESUS CHRIST.

B. TO COME TO GOD THROUGH FAITH, WE MUST RENOUNCE OUR MERIT AND WORKS AS THE BASIS FOR APPROACHING GOD.

C. TO COME TO GOD THROUGH FAITH, WE MUST ENTRUST OUR RIGHT STANDING WITH GOD TOTALLY TO THE MERITS AND SUBSTITUTIONARY DEATH OF JESUS CHRIST ON OUR BEHALF.

John Calvin expressed this beautifully (*Calvin's Commentaries* [Baker], p. 379):
But how they stumble at Christ, who trust in their works, it is not difficult to understand; for except we own ourselves to be sinners, void and destitute of any righteousness of our own, we obscure the dignity of Christ, which consists in this, that to us all he is light, life, resurrection, righteousness, and healing. But how is he all these things, except that he illuminates the blind, restores the lost, quickens the dead, raises up those who are reduced to nothing, cleanses those who are full of filth, cures and heals those infected with diseases? Nay, when we claim for ourselves any righteousness, we in a manner contend with the power of Christ; for his office is no less to beat down all the pride of the flesh, than to relieve and comfort those who labor and are wearied under their burden.

Alva McClain: It is a solemn possibility to be a member of the visible church and not a member of the invisible church. That is the lesson for us today. It is possible to be humanly numbered among the people of God and yet not to be a true child of God. A second lesson is that spiritual life does not come through physical birth. Your father and your mother, and all your family as far back as you can trace, may be Christians, but that won't make you a Christian any more than it made Ishmael and Esau Israelites because they were born of Abraham and Isaac.

Leedy Greek NT Diagrams:

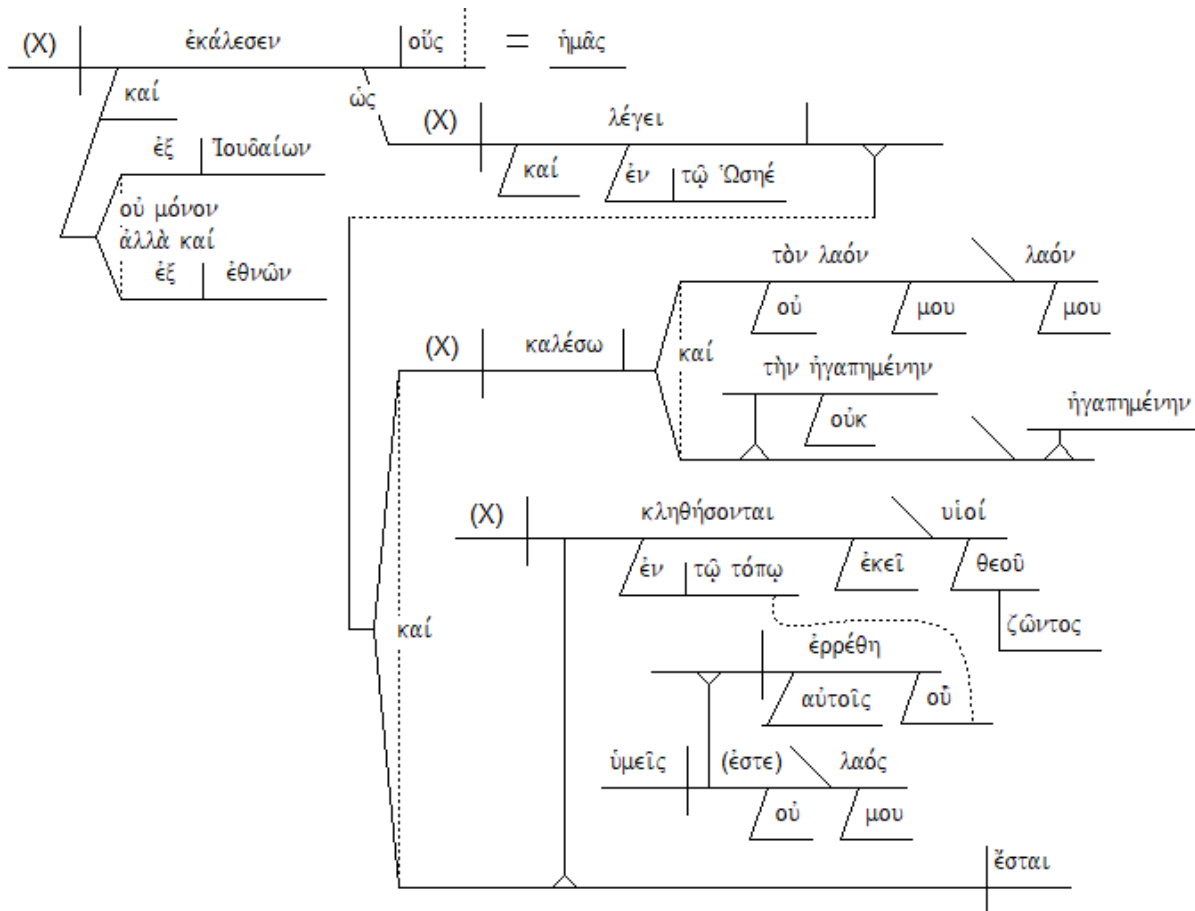

Rom 9:27-28

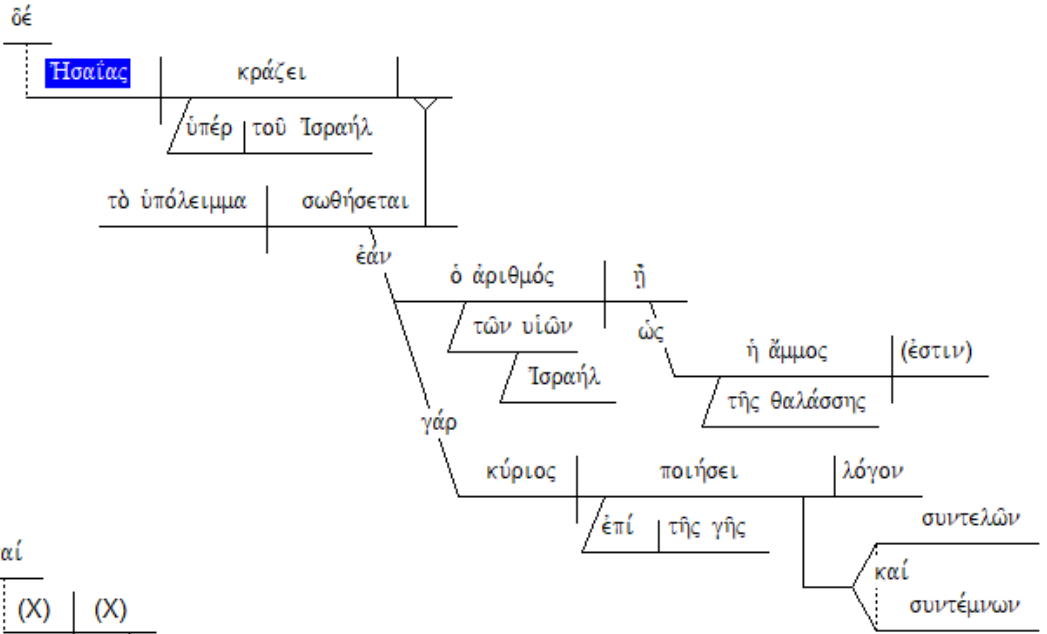

Rom 9:29

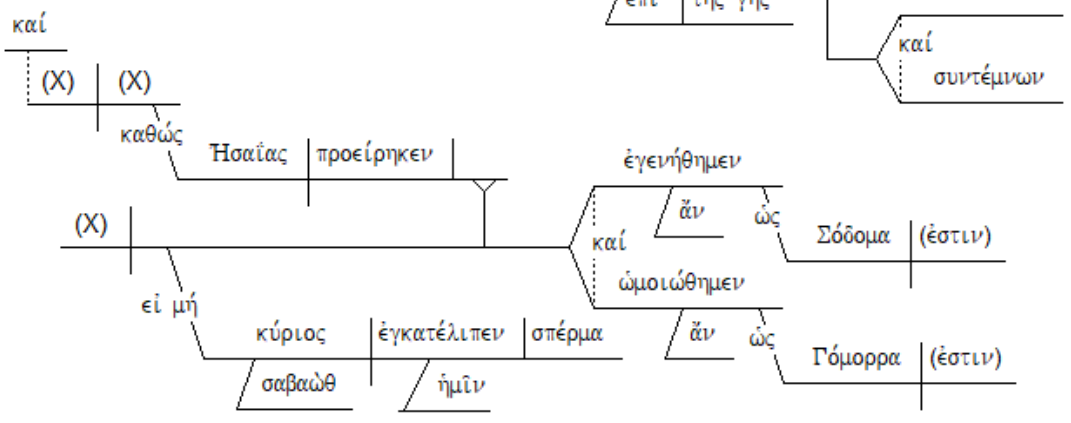

Rom 9:30-31

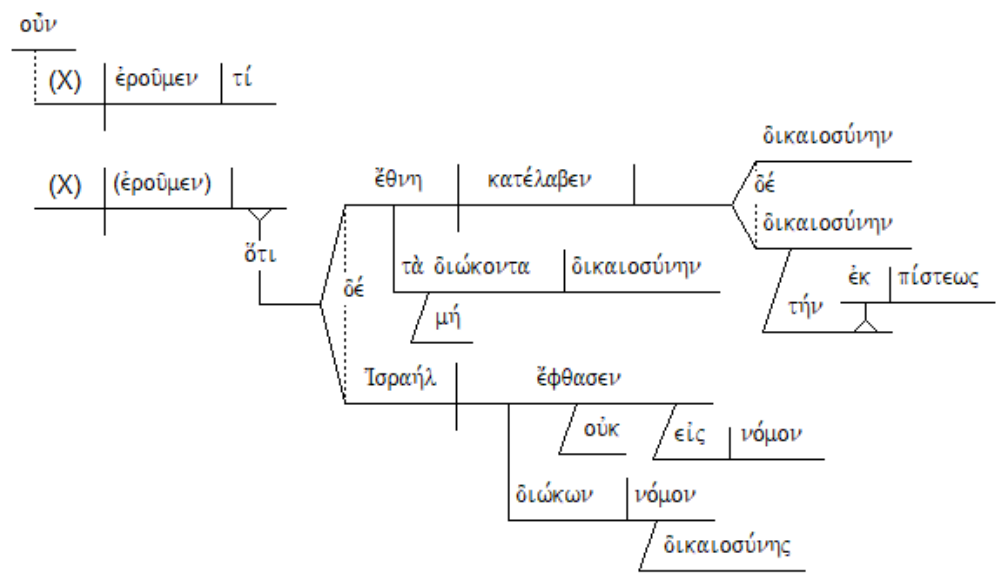

Rom 9:32-33

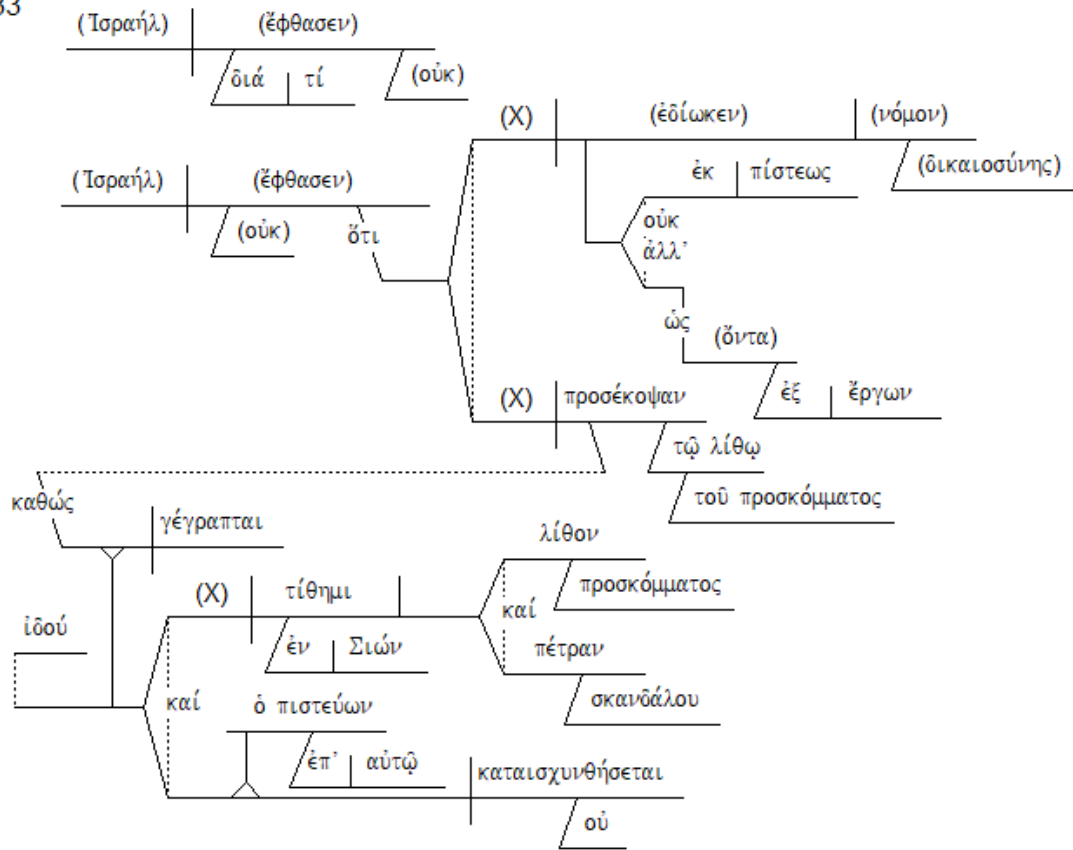

Frank Thielman:

25–26 Verification (of 24b)

As he also says in Hosea.
"I will call 'Not My People' 'My People,' and
'Not Loved' 'Loved' (Hos 2:23), and
it will happen that
in the place where it was said to them, 'You are not my people,'
there
they will be called sons of the living God." (Hos 1:10)

27–28 Verification (of 24a)

But Isaiah cries out concerning Israel,

"If the number of the sons of Israel be as the sand of the sea,
the remnant will be saved,
for the Lord, acting conclusively and efficiently, will perform his word on the earth." (Isa 10:22–23)

29 Restatement
(of 27–28)

And, just as Isaiah predicts,

"Unless the Lord Sabaoth had left us offspring,
we would have become like Sodom and
been made like Gomorrah." (Isa 1:9)

30a Rhetorical Question

What, then, shall we say?

b Assertion

That gentiles who were not pursuing righteousness
attained righteousness, that is,
righteousness by faith,

c Description

31a Contrast

but **Israel**, although pursuing a law of righteousness,
did not arrive at that law.

32a Rhetorical Question

Why?

b Basis (for 31a)

Because **not by faith**, but as if
by works.

c Contrast

d Assertion

They stumbled
on the stumbling stone,

33a Verification

just as it is written,
"Look! I put in Zion (Isa 28:16a) a stone of stumbling and
a rock of offense (Isa 8:14), and

b

c Assertion

the one who believes on him will not be ashamed." (Isa 28:16b)

TEXT: ROMANS 10:1-13

TITLE: THE SIMPLICITY OF SALVATION IN CHRIST

BIG IDEA:

SALVATION IS EASY -- WHOEVER TRUSTS IN CHRIST'S RIGHTEOUSNESS AND NOT IN HIS OWN WILL BE SAVED

INTRODUCTION:

Douglas Moo: Paul's ultimate criticism of Israel is not just **salvation-historical**—Jews failed to see that God was doing something new with the Gentiles. It is also **anthropological**—Jews failed to seek a relationship with God in the right way. Both criticisms are found in this context. Jews are faulted for failing to recognize Christ as the culmination of God's plan (**10:4**) and the rock on which the new people of God is to be built (**9:33**). But Paul also faults them for being overly concerned with works and neglecting faith (**9:32**).

R. Kent Hughes: Here in **chapter 10** God places the responsibility for Israel's lostness on Israel. God rejected Israel because Israel rejected the gospel. If you are without Christ, it is not because you are non-elect, but because you are rejecting Christ. You cannot place the blame on anyone else. At least five times in this chapter (vv. **8, 11, 12, 16, and 21**) the responsibility of the Jews is implicitly emphasized, concluding with the poignant plea of **verse 21**: "*But of Israel he [God] says, 'All day long I have held out my hands to a disobedient and contrary people.'*"

John MacArthur: Now we could entitle **chapter 10** "*Israel's Failure*," or we could entitle it "*Israel's Ignorance*." And either one of those titles would give us the theme of this chapter. . .

the issue of **chapter 9** is an issue of **election**. It is an issue of **sovereign choice**. But the issue of **chapter 10** is an issue of **unbelief**. And I want you never to forget that you always have both of those things. If you have salvation, you have the sovereign election of God and you have the faith of an individual. If you have the loss of...the lack of salvation, the loss of hope in Christ, it is because you have sovereign choice, that's **chapter 9**, and because you have unbelief. You could think of it along the line of concurrence, which is a word that you may have heard used. It's sort of like an airplane taking off. Two things are necessary for an airplane to take off, thrust and lift. If you have lift without thrust, you don't get off. If you have thrust without lift, you don't get off. You have to have thrust with lift.

S. Lewis Johnson: When we come to **chapter 10**, the apostle gives us the other side. He talks about **human responsibility**. Now when we talk about human responsibility we don't want to misunderstand the apostle. We don't want to imply in any way that when we talk about human responsibility that we're talking about human works. Occasionally these things are mixed in the minds of believers. The apostle when he speaks about divine sovereignty does not oppose divine sovereignty to human works, but he speaks about divine sovereignty and then he speaks about human responsibility. **Human responsibility is the requirement to respond to the sovereign grace of God as expressed in the gospel of Jesus Christ.**

I. (:1-4) SALVATION ELUDES THOSE WHO TRY TO EARN IT – SADLY, ISRAEL DID NOT ACCEPT THE RIGHTEOUSNESS OF CHRIST, BUT TRIED VERY HARD TO EARN THEIR SALVATION

A. (:1) Burden for Lost Countrymen

“Brethren, my heart's desire and my prayer to God for them is for their salvation.”

John MacArthur: Now when he says "*brethren*," he's writing to **Gentiles** and that's a tender word and maybe the feeling that he had in his heart for the Jews kind of spilled over in his choice of words toward the Gentiles, too. And then he says, "*My heart's desire*," or my delight, or my good pleasure, it's translated sometimes, or my deepest satisfaction. The greatest joy for Paul and it says "*prayer to God*," my greatest satisfaction and my greatest prayer and the word prayer there, *deēsis* is a word that conveys the idea of **begging, pleading**. My greatest desire, my greatest pleading with God is for Israel's salvation. So listen, don't you for a minute think that Paul is some cold, calculating indifferent, hyper-Calvinist standing off, spewing out data about God's sovereign election without a heart for the lost. His desire is so deep and so strong that his heart cannot rest in complacent theological indifference. It is drawn unceasingly to a beseeching, begging, supplication to God, it says, for Israel that they might be saved. They were in his heart.

Frank Thielman: Paul uses the vocative "*brothers and sisters*" (ἀδελφοί) at the beginning of a sentence when he wants to emphasize what he is about to say (**1 Cor 14:20; Gal 3:15; 6:1; 1 Thess 5:25**). Here the expression calls attention to the depth of Paul's hope that Israel's stumbling, described in **9:32–33**, might not be permanent.

James Dunn: As elsewhere in Paul, καρδία denotes the **inward person** (see on **1:21; 2:15; and 8:27**), and therefore the depth and sincerity of his claim, a motivating force which engages the whole person, not just a "mere feeling."

B. (:2-3) Blame Falls on Israel

1. (:2) Zeal without Discernment

*“For I bear them witness that they have a zeal for God,
but not in accordance with knowledge.”*

John Toews: The problem with Israel's **zeal** is that it is without knowledge and ignorant, which literally means **lacking discernment**, the ability to differentiate the true nature of reality. The language is full of irony. In its zeal for God Israel misunderstands the very criterion by which zeal is to be evaluated, **true knowledge of the will of God**.

The object of knowledge, or the point of ignorance, is **righteousness**. The contrast is the righteousness of God (the language of **1:16-17** and **3:21-26**) and their own righteousness, the saving power of God to make the world right versus the exclusive ethnic righteousness of Israel.

Michael Bird: Nevertheless, despite their zeal, Israel lacks "*knowledge*," knowledge in the sense of both awareness and assent to the divine saving action in Jesus the Messiah. . . Israel has

demonstrated her ignorance of God's deliverance wrought in the Messiah. It shows a lack of awareness about the Torah's intrinsic limitations and an accompanying denial of Israel's own disobedience to the Torah. In addition, some in Israel denied God's impartiality toward all people and have not accepted the arc of prophetic promises that embrace the nations. In other words, they are ignorant of the entire sweep of argumentation set forth in **Romans 1:16 – 9:33**.

R. Kent Hughes: It is so easy for a zealous person to be lost if one thinks religion exists as a ladder to elevate oneself to righteousness and acceptance before God.

S. Lewis Johnson: Why is Paul so concerned for Israel? Well in **chapter 9**, he said he was so concerned for them because they've have such large privileges, and they have neglected them. And even though they have these great privileges, they're lost. In other words, the contrast between their high position and their low status is such as to cause him to say "I have great heaviness and continual sorrow in my heart." He looks at the objective side of it. But now in **chapter 10**, he looks at the subjective side of it. He says, "*I bear them witness that they have a zeal for God, but not according to knowledge.*"

2. (:3) Rejection of God's Provision of Righteousness

"For not knowing about God's righteousness, and seeking to establish their own, they did not subject themselves to the righteousness of God."

Frank Thielman: Paul now says that unbelieving Israel has stumbled over Christ by rejecting his death as God's means of atonement for universal human sin against himself (cf. **9:33; 1 Cor 1:23; Gal 5:11**). This rejection left them running energetically down the pathway of the law under the illusion that their rejection of Christ and focus on the law itself was conformity to the will of God.

James Dunn: God's righteousness can only be received in humble subjection, the creature recognizing its total dependence on the Creator. Israel had indeed recognized the need for obedience to the law, but unfortunately had so misunderstood what that obedience entailed that their zealous obedience had actually become disobedience, a zeal attested more by sword than by love of neighbor. By pursuing obedience at the level of the flesh (cf. **8:7**), in terms of ethnic and particular rituals, they showed their misunderstanding of God's righteousness; and, irony of ironies, by seeking to establish righteousness as something peculiarly theirs they were actually putting themselves outside God's righteousness, resisting rather than receiving the saving grace of God.

John MacArthur: Now what were they ignorant of? Five things are outlined in this chapter. Five elements in the ignorance of Israel.

- They were ignorant of the person of God.
- They were ignorant of the provision of Christ.
- They were ignorant of the place of faith.
- They were ignorant of the parameters of salvation.
- And they were ignorant of the predictions of Scripture.

Tremendous chapter, so wonderfully laid out by the genius of the Holy Spirit. And this ignorance... And may I suggest to you what we've been saying all along, it is a **willful**

ignorance. They chose not to believe the truth. They chose to close their ears and their eyes until God finally judicially did it for them. It was ignorant, but it was willing ignorance. It was unbelief, but it was willing unbelief. Paul is sorry about it, as **verse 1** indicates. But nonetheless **it was their own fault.**

C. (:4) Basis for Salvation = Christ is the Goal – Providing Righteousness via Faith

“For Christ is the end of the law for righteousness to everyone who believes.”

S. Lewis Johnson: The expression, *Christ is the end of the law*, is a notoriously difficult one, because the term end may be given several different senses. Perhaps, since there are several meanings that are in harmony with the teaching of the Scriptures, it would be helpful to set forth some of the suggestions.

First, some have taken the word "end" in the sense of **the goal** (Interpretation #1). That is, Christ is the goal of the Law. The Law was intended to point forward to Him by acting in its office of convictor of sin (cf. Ro 3:20). In that sense it was the slave guardian that led men to Christ (cf. Gal. 3:24).

Second, it has been taken to mean end in the sense of **antitype** (Interpretation #2). In this context it would mean that all the types of the Old Testament pointed on to Christ. He is the One to whom the Levitical cultus pointed, being the burnt offering, the peace offering, the meal offering, the sin and trespass offerings, the Passover, etc. (cf. Heb 10:1). It is true that the Old Testament is full of illustrations of the coming Redeemer; they pointed on to Him.

Christ is the “end” of the law in the sense that those sacrifices pointed forward to him, illustrated what he would do when he came. He was the burnt offering. He was the meal offering, he is the meal offering. He is the peace offering. He’s the sin offering. He’s the trespass offering. He’s the drink offering. He’s the offering of the red heifer, all of the offerings. He is the great offering on the Day of Atonement. All of these things were to give us little bits of self understanding concerning the Lord Jesus Christ. Everything gathered together when the Lamb of God came. He’s the end of the law; he’s the antitype of all of these types expressed in the Old Testament. Now the writer of the Epistle to the Hebrews speaks about the law “*being a shadow of good things to come.*” That’s what Paul may be speaking about here.

Third, most of the commentators have taken the word "end" in the sense of **termination, finish, wind-up** (interpretation #3). The old order, the legal age, is done away in Christ, even as a hypothetical means of salvation (no one could be saved by the Law, for all men are sinners, Christ excluded; cf. **Gal. 3:10, 11, 12**). The new order of the Spirit is here. This is likely the force of the text. Righteousness is only available in Jesus Christ and His sacrifice.

John Toews: The law is fulfilled by Messiah Jesus in relationship to righteousness for all who exercise faith. The law’s relationship to righteousness is fundamentally changed by Christ. Paul’s thesis here is a restatement of **8:4**, Messiah Jesus did what the law was not able to do and thus fulfilled the objective of the law. Christ does that for all people who trust; the universalism of the gospel, for all people (see **1:16**), replaces the particularity and exclusiveness of Jewish nationalism. Christ, law, righteousness, and faith, all key terms in Romans, are bound together in

a provocative interpretation. The law is a good thing that Christ brings to the goal of God's righteousness for all people of faith.

Frank Thielman: The imagery of **pursuit** that Paul has been using in **9:30 – 10:3** weighs heavily in favor of taking the term to mean “*goal*” or “*purpose*” [instead of *termination* or *end*] (cf. **6:21–22**). Although he has not used the term “*goal*” before in **9:30 – 10:3**, the idea of pursuit in order to reach a goal has nevertheless dominated the discussion. Gentiles reached the goal of righteousness without pursuing it (**9:30**). Israel pursued the law of righteousness but did not arrive at that law (**9:31**), and they failed to arrive at the law because they focused on works and stumbled over the immense significance of the atoning death of Christ (**9:32–33**). They pursued the law in the wrong way and therefore failed to arrive at the “goal” toward which the law should have led them. If instead of attempting to keep the law after being confronted with the gospel they had viewed the law through the lens of the gospel, they would have realized that the law points to Christ.

How does the law do this? It promises righteousness and life to those who keep its commands (**10:5**), but also indicts all humanity, Israel included, for not keeping those commands. Apart from the work of the Spirit in the lives of God's people (**8:4**), the law can, in practice, only bring knowledge of sin (**3:20**) and God's wrath (**4:15**). The law, then, describes the human plight and, by doing this, implicitly **points to Christ**. This is the sense in which Christ is the **law's goal**.

Douglas Moo: With the coming of Christ, the **goal** toward which the law was pointing has been reached. I think this latter idea is close to Paul's point. But if we think about it a minute, we will see that the idea of “**end**” is bound up with this meaning also. Paul may well here be thinking of the **race course imagery** he has used in **9:30–32** (“*pursuing*” and “*obtaining*”). Let's picture Israel as the runner, the law as the race, and Christ as the finish line. What Israel has failed to understand, Paul is saying, is that the finish line has been reached. The Messiah and the salvation he brings have come. Thus, the “*race*” has attained its end and goal—or, to use the best English equivalents, its “*culmination*” or “*climax*.”

As a result of Christ's coming and bringing the law to its culmination, **righteousness is now available for everyone who believes**. Christ opens a new phase in salvation history, in which God extends his offer of a right relationship with himself to Gentiles as well as to Jews. Faith, apart from ethnic origin or works, is the sole basis for experiencing this gift he offers to the world.

II. (:5-10) SALVATION INVOLVES SIMPLE FAITH AND CONFESSION REGARDING THE FINISHED WORK OF CHRIST

Frank Thielman: Paul explains from Scripture why unbelieving Israel's elevation of the law over Christ as the way to righteousness and life is misguided (**10:5–13**). According to the law itself, one must “*do*” the law in order to gain righteousness and life by it (**10:5; Lev 18:5**), but this is something that Paul has shown earlier in the letter's argument to be impossible (**Rom 3:19–20; 4:15; 5:20; 7:7–25; 8:7**). According to the gospel, however, righteousness comes to those who simply trust in the effectiveness of what God has done for them through the death and

resurrection of Christ. This is consistent with what the Scriptures say about the need for God to transform the hearts of his people to make them capable of obeying and calling upon him (**Deut 30:11–14** [cf. **Deut 29:4**; **30:1–10**]; **Joel 2:32**).

Douglas Moo: **Verses 5-13** elaborate on the two key points Paul has made in **verse 4**:

- Christ ends the era of the law, making available a righteousness that can be attained through faith (**vv. 5–10**);
- and this righteousness is now available to anyone who believes (**vv. 11–13**).

A. (:5) Impossibility of Gaining Salvation by Obedience to the Law

“For Moses writes that the man who practices the righteousness which is based on law shall live by that righteousness.”

B. (:6-7) Implications of Incarnation and Resurrection of Christ – Righteousness Based on Faith Depends on the Finished Work of Christ

“But the righteousness based on faith speaks thus,”

1. (:6) Implications of the Incarnation

*“Do not say in your heart, ‘Who will ascend into heaven?’
(that is, to bring Christ down),”*

Frank Thielman: In contrast to the impossible task of fulfilling the law as a way of receiving righteousness and life, receiving righteousness and life by faith is **easy**. The difficult task has already been accomplished by Christ’s descent from heaven to reconcile people to God through his death on the cross.

2. (:7) Implications of the Resurrection

*“or ‘Who will descend into the abyss?’
(that is, to bring Christ up from the dead).”*

Frank Thielman: Christ’s **resurrection** from the dead was also part of the difficult task of gaining righteousness and life for the believer, but just as God sent Christ down from heaven that people might live, so he raised Christ from the dead for the same reason. Nothing is left for people to “do” in order to be reconciled to God and live with him eternally. God has already done it all for them.

Paul continues his description of the easy availability of righteousness through the gospel by matching an imaginary and impossible ascent to bring Christ down from heaven with a hypothetical and equally impossible descent into the abyss to lead Christ up from the dead. The impossibility of both tasks matches the impossibility of keeping the law well enough to receive life by doing it (**10:5**). Paul’s point is that through the incarnation and resurrection of Christ **God has already done everything necessary to provide righteousness and life for the believer.**

Grant Osborne: Before people even begin to look for God, he is already present, and no matter how far they go out of their way to find him, he is never farther away than when they first started

out. As long as we insist on doing the finding, we will discover that the search never ends. But if we begin by trusting God, we discover he is to be found right where we are.

S. Lewis Johnson: In other words, Moses is simply saying that the word of faith is not something that we have to go and get. **It's not something difficult. It's the simple response of the heart to the word of God.** Now, the apostle, by analogy, speaking rhetorically uses those expressions here in **verse 6** and following, he says with reference to the righteousness of God, and remember, Paul writes from the standpoint of the finished work of the Lord Jesus. The cross has already taken place. *"But the righteousness which is of faith speaketh on this wise, Say not in thine heart, Who shall ascend into heaven? (that is, to bring Christ down from above:)"* In other words, we do not have to go into heaven to precipitate an incarnation by which the second person of the divine trinity should take to himself human nature and come down upon this earth. We don't have to do that. It has already been done, Paul is affirming.

Furthermore, we don't have to say, or the word of faith, the righteousness of God does not say, *"Who shall descend into the deep? (that is, to bring up Christ again from the dead.)"* We do not have to descend into the depths and bring up Christ in his resurrection so that he ascends to the right hand of the Father. The work of the Son of God in coming, as the incarnate second person, dying on the cross, entering into his grave, coming forth from the grave in victorious resurrection, has already been accomplished. It is not something that we do; it's something that we trust. It's not something that we are responsible for ourselves. We simply, through the word of God, observe what has happened for sinners, and we trust ourselves in what God has done for us. The apostle is saying then, there is no human merit that God recognizes. There is no human supplement that we must offer to the work of God. The righteousness of God is not something that we attain to by our activities. It is something that we obtain through free grace. It's not a new start that we need to start over to try to keep the Law of God from today. But is an absolutely new heart that comes through the work of the Holy Spirit in regeneration; who through the gospel of Christ transforms us, gives us new life so that we respond in faith and repentance and trust in the Lord Jesus Christ. That's the Old Testament expression of the righteousness of God.

C. (:8-10) Instruction Regarding God's Plan of Salvation

1. (:8) The Gospel Message of Faith in Christ Is Accessible

"But what does it say? 'The word is near you, in your mouth and in your heart '-- that is, the word of faith which we are preaching,"

Frank Thielman: In contrast to the impossibility of gaining righteousness and life through doing the law, receiving righteousness and life through the gospel is simply a matter of sincerely embracing the good news, proclaimed by the apostles, that God has already gained righteousness and life for people in Christ.

R. Kent Hughes: Simply stated, we do not have to go to Heaven or into the world of the dead to find Christ. He is near us. Nor does salvation belong to the elite who have taken mystical journeys to Heaven or Hell. For those who knew something of the Scriptures (as the Jews knew the Law), the saving word was on their lips and heart. That is, the gospel of Christ—the word of faith—was (and is) available, accessible, and simple. . .

Why do so many people miss the point? Because it does not jibe with the concept of religious self-elevation. It is just **too simple**.

The good news is the ultimate both in **simplicity** and **mystery**. We will never completely understand it in this world. Yet it is so simple that a twelve-year-old can understand enough to truly come to Christ.

John MacArthur: So, the righteousness that comes to men is a righteousness that's very high because it must meet the infinite standard of the holiness of God. It's a righteousness that we can't gain on our own and so Christ provides it for us. And it is appropriated to us by what? By faith, by believing, not by pursuing it, not by trying to ascend to heaven or descend into the depths, but by receiving it.

2. (:9) The Gospel Message of Faith in Christ Promises Salvation Based on Confession and Trust

a. Confession of Submission to Jesus as Lord

“that if you confess with your mouth Jesus as Lord,”

Michael Bird: This verse is perhaps the best explanation of what it means to be a Christian. A Christian is someone who professes to **live under submission of King Jesus** and believes that God has acted in Jesus to usher in the age to come. Not only that, what is provocative is that Paul writes these words to a cluster of house churches in the heart of the Roman empire, living right under the emperor's nose and boldly declaring the lordship of a Jewish man executed by the Romans as a common criminal. It's provocative because the Roman emperor was the one hailed as *Kyrios* by supplicants and clients across the empire. At the time that Paul was writing, one can find inscriptions, papyri, and ostraca all attesting that “Nero is Lord,” even the grandiose claim that “Nero, the Lord of the entire world.” Whether Paul intends the statement “*Jesus is Lord*” to be heard as a deliberate sociopolitical protest against the propaganda of the imperial cult is debatable. But at least we should acknowledge that the claim was potentially incendiary and could be perceived as politically disloyal. To claim that “Jesus is Lord” on Lord Nero's own turf was not going to endear the Christians to imperial authorities.

b. Trust in the Resurrection of Christ

“and believe in your heart that God raised Him from the dead,”

Grant Osborne: As has already been noted, neither of these components that establish our personal relationship with God can be reduced to reciting certain words or assenting to the facts. To believe and to confess involve whole-person commitment. Neither are these components described in such a way that a person might accomplish one without accomplishing the other. They are two parts of a single step, just as lifting the foot and then placing it back down are two movements in the one act of taking a step.

John MacArthur: If Paul had picked another event, it wouldn't have been as significant as this. The resurrection says He is Son of God. The resurrection says He is Messiah, He is Savior. He is the ultimate Lamb, the sacrifice for the sins of the world. He is the perfect

one, the sinless one, the one exalted at the right hand of God, the one to be the judge, the one to be the King. The only Savior, the judge of all men, the conqueror of death, the coming King, the eternal monarch of glory; all of that is bound up in the resurrection. And that's what we're called to believe.

- c. Promise of Salvation
“you shall be saved;”

John Toews: The confession has two components: confession of Jesus as Lord and trust in God's resurrection of him from the dead. The first means acknowledging Jesus Christ as Lord of the world and the church. A transfer of allegiance and ownership is announced publicly. The second calls for trust in the faithfulness of God, as the reference to God's resurrection of Jesus and the second use of **Isaiah 28:16** indicates. The goal of the confession and faith is righteousness (confession to righteousness) and salvation (trust to salvation) used here as synonyms. The triple use of salvation in **vv. 9, 10, and 13** in connection with confession and calling on the name of the Lord emphasize that Jesus is the Lord through whom God grants salvation to all people who confess and call on him. The linkage of the key concepts of the letter and of the argument in **9:30f.** in this chiasmic formula—faith, righteousness, salvation—underline Paul's emphasis on righteousness by faith alone for all people irrespective of ethnic heritage (**9:31-32; 10:4**).

S. Lewis Johnson: Saving faith is so **simple**. It's mustard seed kind of faith. It's the faith that tremblingly touches the Savior's garment. It's the faith that says, *“Lord I believe, help thou mine unbelief.”* It's the faith that a sinking Peter, sinking because of unbelief, utters when he says, *“Lord, save me.”* and Jesus reaches out his hand and saves him. And it's the faith of a weeping Mary, concerned over the loss of a savior. It's that simple. It's the faith that trusts Christ. It's the faith that moves out of ourselves and leans upon the one who has died for us. It's the one who accepts him as our continental head who has offered the atoning sacrifice for all for whom he has died. May God in his wonderful grace move in your heart to lean upon Christ for your salvation.

3. (:10) The Gospel Message of Faith in Christ Must be Embraced

- a. Embraced by Belief in the Heart
“for with the heart man believes, resulting in righteousness,”
- b. Embraced by Confession with the Mouth
“and with the mouth he confesses, resulting in salvation.”

III. (:11-13) SALVATION EXTENDS TO ALL WHO WILL BELIEVE WITHOUT EXCEPTION AND WITHOUT DISTINCTION

“For the Scripture says,”

John Toews: Paul emphasizes the unification of all nations before God on the basis of faith in **vv. 9-13**. Messiah Jesus is the fulfillment of the law to everyone who trusts because the goal of the Torah is that all nations become one before God. Out of faith removes all distinction and special privilege. God grants salvation to all who confess Jesus as Lord and who call upon the name of God. Paul again affirms that the word of God has not failed. It is fulfilled in Messiah Jesus.

A. (:11) Salvation Never Disappoints

“Whoever believes in Him will not be disappointed.”

Frank Thielman: The ease with which God makes righteousness available explains the irony that gentiles had attained righteousness without even seeking it, whereas unbelieving Israel, with their zeal for God’s righteous law, had failed to attain it. If righteousness comes to those who merely believe and confess the gospel, then Greeks as well as Jews can receive it. It does not involve, as a first step, becoming a Jew by adopting the Jewish law (cf. **4:9–17**; cf. **Acts 15:7–11**; **Gal 2:14–16**).

B. (:12-13) Salvation Is for All Who Will Believe

1. (:12a) Unity without Distinction for All Who Believe

*“For there is no distinction between Jew and Greek;
for the same Lord is Lord of all,”*

Michael Bird: When God’s **impartiality** is worked out in practice, it means that there is no distinction among Jew and Gentile. This of course was the principle underlying **1:18 – 3:20**, which stated that Jews and Gentiles are both condemned in sin; therefore, Jews and Gentiles both need justification by faith as made clear in **3:22, 29-30**. Clearly, sharing in the same plight entails sharing in the same solution.

But the picture here is far more than Jews and Gentiles simply being stuck with each other in the same lifeboat. Jesus is the same Lord of both Jews and Gentiles because God intends to put all of his people under the headship of one person, Messiah Jesus. God’s plan, first announced to the patriarchs, was always to form a **worldwide family of faith to live under the reign of the Messiah**. So Paul’s reference to Jesus’ lordship is no mere abstract affirmation of his deity. It means in the first instance that our relationship with God is mediated through Jesus as the one appointed as Messiah and Lord. On top of that, Jesus’ lordship necessitates a radical configuration of how believers relate to each other, including followers of Jesus belonging to different ethnicities. There is no “them” and “us,” but only “us” under the lordship of Jesus. Those who believe in the same Lord belong in the same community — a point with significant ramifications later in the letter (see **14:1-11**).

John MacArthur: Now notice **verse 12**. He says, "*Whosoever believes on him shall not be disappointed,*" in **verse 11**. And then he says, "*For there is,*" and this is dynamite, "*no difference between the Jew and the Gentile.*" Man oh man, I mean, you just can't say anything more devastating than that. These people, who were so zealous of their identity, who to this very day have preserved themselves through all the centuries because of a zeal for their own racial identity and a zeal for their own religious heritage, whether they believe it or not. These people, who believe so strongly that they are different than Gentile people, are told by Paul there's no difference, no difference. What a statement.

2. (:12b) Unlimited Riches for All Who Believe

“abounding in riches for all who call upon Him;”

3. (:13) Universal Invitation and Promise to All Who Believe
“for *Whoever will call upon the name of the LORD will be saved.*”

Douglas Moo: The verb “call on” (*epikaleo*) is apparently the trigger that leads Paul to yet another Old Testament text that underscores the universality of God’s offer in the gospel (**Joel 2:32**): “*Everyone who calls on the name of the LORD will be saved.*” The “LORD” in Joel is Yahweh, the covenant name of God. But Paul identifies this “Lord” with Jesus (see **Rom. 10:9, 12**), the “stone” of **Isaiah 28:16 (Rom. 10:11)**. **Verse 13**, then, is important evidence that the early Christians **identified Jesus with God**.

Grant Osborne: A final quotation taken from the Hebrew Scriptures (**Joel 2:32**) serves well for Paul’s conclusion. **God’s special relationship with Israel will continue**, but it has been **broadened** to include everyone who calls on the name of the Lord. God’s plans for Israel had their climax in Christ. Access to God, for all people, now comes through Jesus Christ. With this last reference, Paul neatly lays the foundation for the necessity of worldwide evangelism. **Joel 2:32** is an Old Testament **mandate for missions**. To call on the Lord is to ask the Lord to come to you and be real to you. Those who call on Jesus as their Lord want him to be their Lord and Savior.

* * * * *

DEVOTIONAL QUESTIONS:

- 1) Do we have a compassionate **burden for the lost** around us?
- 2) How do cult members exhibit a *zeal without knowledge* and how can we try to graciously expose their lack of spiritual discernment?
- 3) What do you think it means for Christ to be the *end of the law*?
- 4) Why is it so important to avoid **favoritism** or **showing partiality**?

* * * * *

QUOTES FOR REFLECTION:

S. Lewis Johnson: The apostle’s sermons were difficult not because of the depth of their content, but **simple** because we are not tuned into the grace of God. We don’t understand grace today. We understand morality, but not grace. But morality is not what the apostle proclaimed, except in so far as it was the product of the grace of God. It is by grace that believers are saved, not by morality. It is by grace that we are built up and not by sermons on morals. Satan is very disturbed when sermons are preached on grace, but he rejoices when the vein of indignation and anger rises in the minister’s forehead and he preaches a sermon on morality. What he especially hates is a sermon of grace, because it is through grace that we become different people, and the results of a different life flow out of that. The apostle preached grace. That’s what made him difficult to understand. **It’s very simple for a person who understands grace.**

Matthew Henry: The scope of the apostle in this part of the chapter is to show the vast difference between the righteousness of the law and the righteousness of faith, and the great pre-eminence of the righteousness of faith above that of the law; that he might induce and persuade the Jews to believe in Christ, aggravate the folly and sin of those that refused, and justify God in the rejection of such refusers.

Grant Osborne: WHY GOOD INTENTIONS CAN'T SAVE US

- Starting out with good intentions does not ensure the results will be good.
- Possessing good intentions does not guarantee that any action will be taken.
- Good intentions by themselves do not fulfill the demand to love God with all our heart, soul, mind, and strength.
- Our ever-present bad intentions are often hidden from us.
- Good intentions can lead to false pride.
- Good intentions can seek to bypass and alter God's clear commands.
- Good intentions can be a cover-up for ignoring or willfully disregarding God's desires.
- Good intentions may appear to make up for bad deeds, but they cannot actually do so.

Many people claim that they are acting with good intentions when, in fact, their efforts are halfhearted. They want to dictate the way God should accept them. But none of our best intentions can save us.

Warren Wiersbe: The theme of this chapter is Israel's present rejection. Paul moved from divine sovereignty (**Rom. 9**) to human responsibility. He continued the theme of righteousness introduced at the end of the previous chapter (**Rom. 9:30-33**) and explains three aspects of Israel's rejection.

1. They did not feel a need for salvation (v. 1).

They were zealous for God (v. 2). (but without knowledge or discernment)

2. They were proud and self-righteous (v. 3).

3. They misunderstood their own law (vv. 4-13).

The entire section emphasizes the difference between "*law righteousness*" and "*faith righteousness*." The contrasts are seen in the following summary:

Law Righteousness

Only for the Jew
Based on works
Self-righteousness
Cannot save
Obey the Lord
Leads to pride

Faith Righteousness

For "*whosoever*"
Comes by faith alone
God's righteousness
Brings salvation
Call on the Lord
Glorifies God

Leedy Greek NT Diagrams:

Rom 10:1

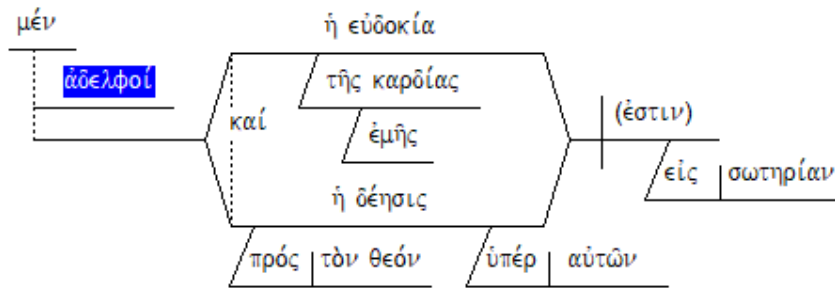

Rom 10:2-3

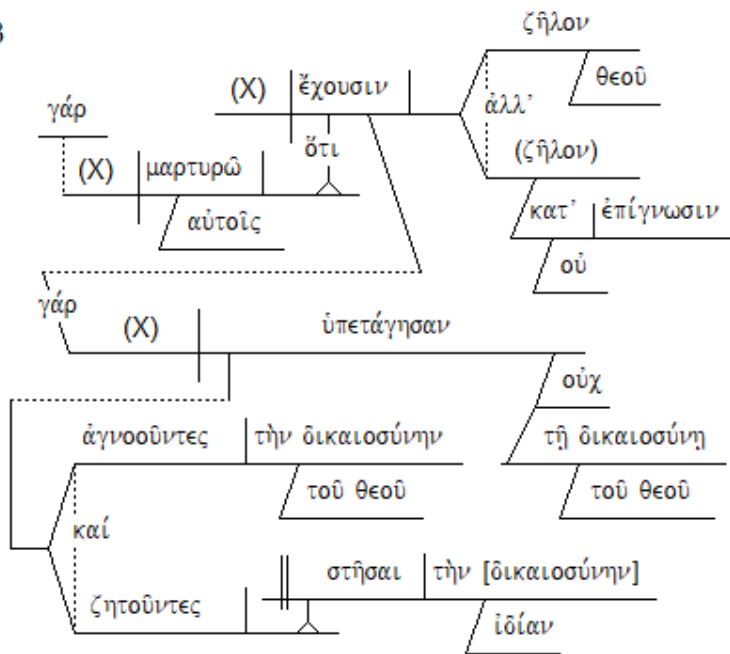

Rom 10:4

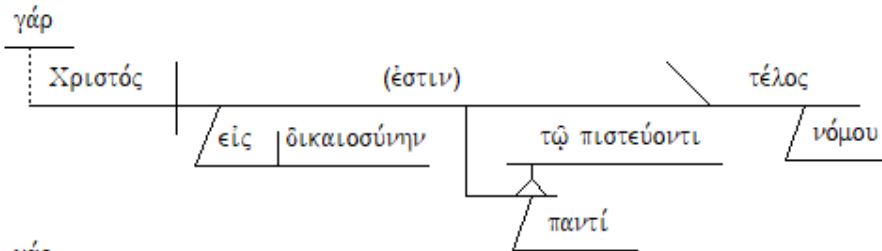

Rom 10:5

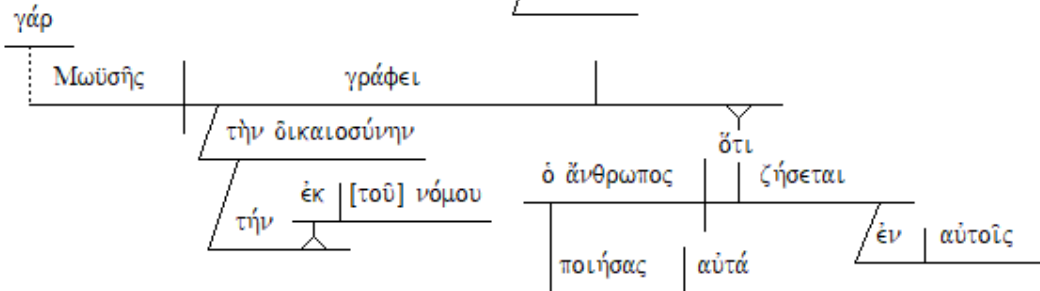

Rom 10:6-7

οέ

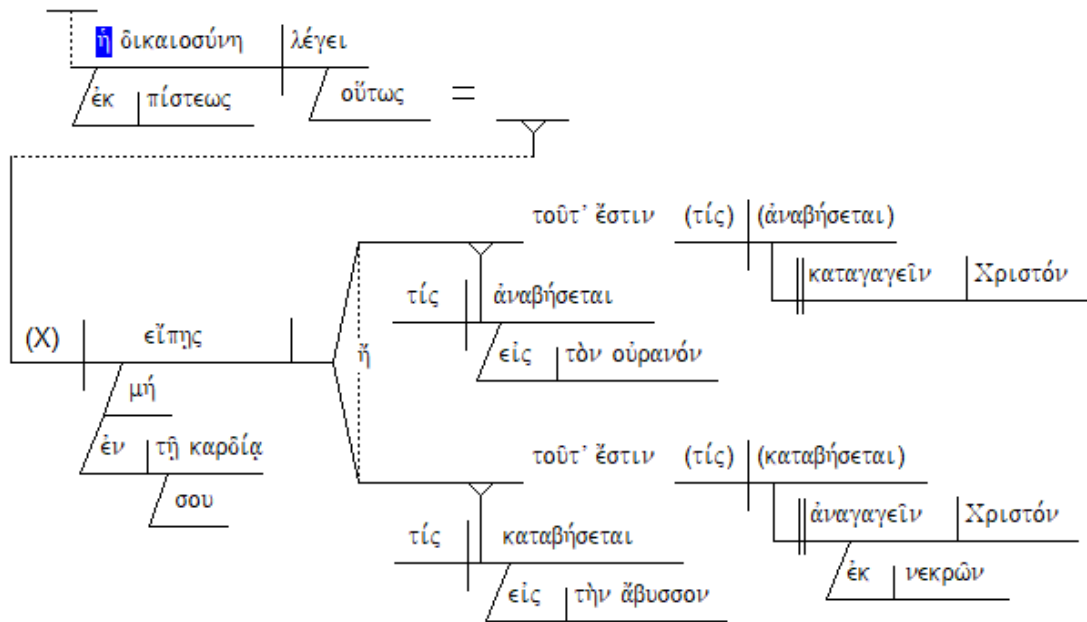

Rom 10:8

ἀλλά

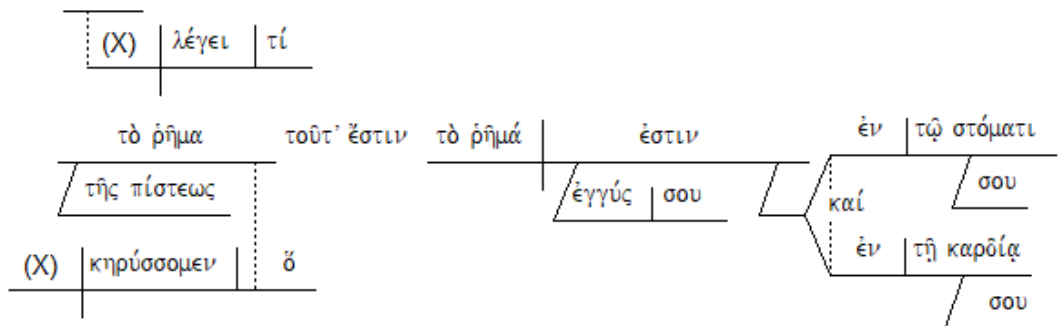

Rom 10:9-10

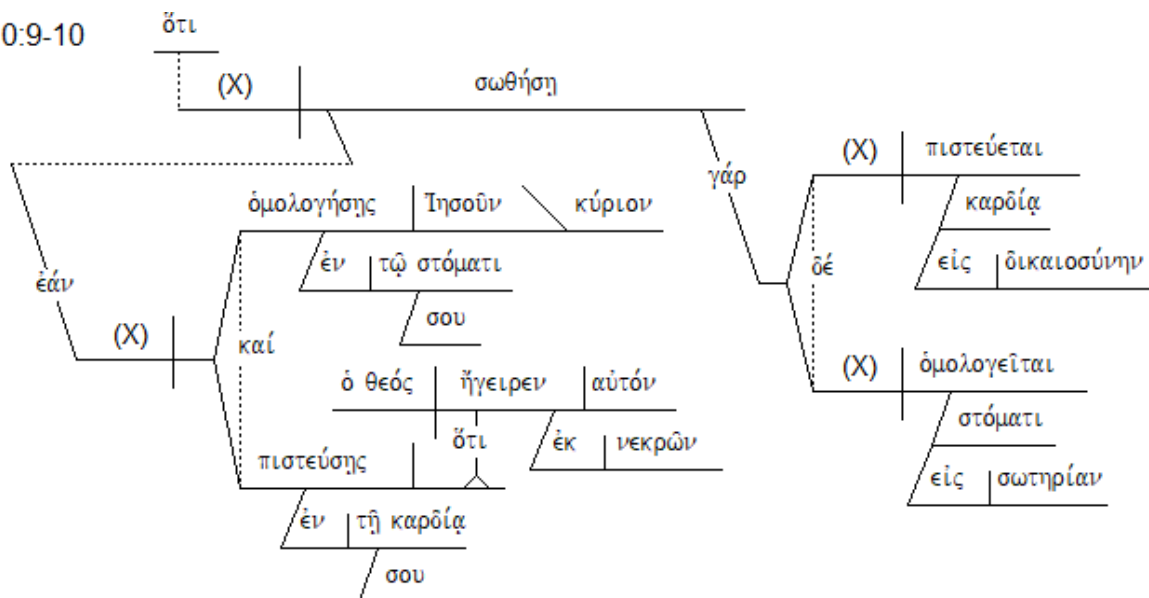

Rom 10:11

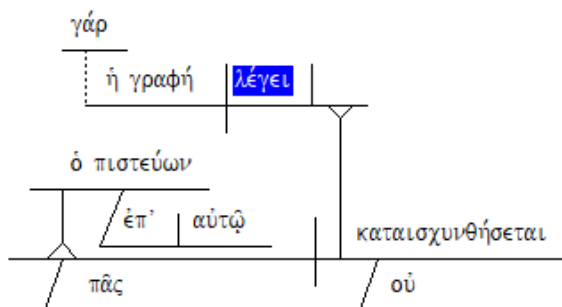

Rom 10:12-13

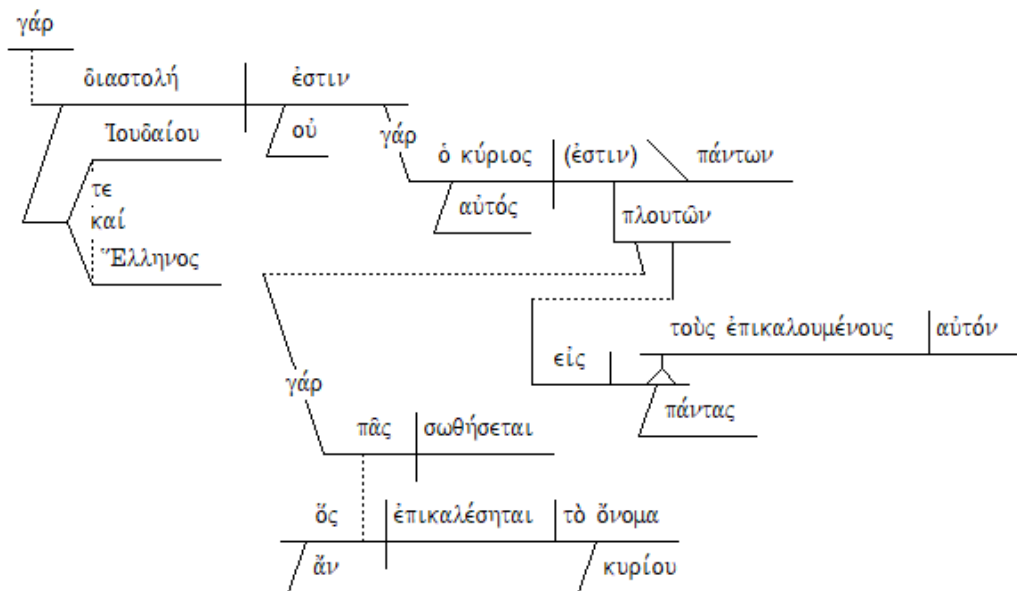

Frank Thielman:

- 10:1a Address Brothers and sisters,
b Assertion **the desire of my heart and my petition to God for them is for their salvation.**
- 2a Basis For **I testify to them that they have** zeal for God, but
b Contrast not according to knowledge.
- 3a Cause (of 3c) For, being ignorant about the righteousness of God, and
b Cause (of 3c) seeking to establish their own righteousness,
c Assertion **they did not submit to the righteousness of God.**
- 4a Basis (for 3c) For **Christ is the goal of the law,**
b Result (of 4a) with the result of righteousness for everyone who believes.
- 5 Verification (of 4b) For **Moses writes about the righteousness from the law,**
“The human being who does them will live by them.” (Lev 18:5)
- 6a Contrast (to 5) But **the righteousness from faith says this:**
“Do not say in your heart, (Deut 9:4)
“Who will go up to heaven?”” (Deut 30:12; Ps 107:26a)
b Purpose —that is, to bring Christ down
or,
7a Restatement (of 6a) “Who will go down into the abyss?” (Deut 30:13; Ps 107:26b)
b Purpose —that is, to bring Christ up from the dead.
- 8a Contrast (to 6a–7b) But **what does it say?**
“The word is near you, in your mouth and in your heart.” (Deut 30:14)
b Description —That is, the word of faith that we preach.
- 9a Basis (of 8a)/ Because if you confess with your mouth that the Lord is Jesus and
Condition (of 9c) believe in your heart that God raised him from the dead
b Condition (of 9c) **you will be saved.**
c Assertion
- 10a Explanation (of 9b) For with the heart
b **it is believed,**
c Result (of 10a) resulting in righteousness,

- d Explanation (of 9a) and with the mouth
it is confessed,
- e Result (of 10c) resulting in salvation.
- 11 Inference (of 10) So **the Scripture says,**
"Everyone who believes on him will not be ashamed." (Isa 28:16b)
- 12a Inference (of 11) So **there is no distinction between Jew and Greek,**
- b Basis (of 12a) for **the same Lord is over all,**
- c Result (of 12b) being rich toward all who call upon him.
- 13 Verification For, "Everyone who calls upon the name of the Lord will be saved." (Joel 2:32)

TEXT: ROMANS 10:14-21

TITLE: INEXCUSABLE JEWISH REJECTION OF WORLDWIDE GOSPEL PROCLAMATION

BIG IDEA:

GOD SENT THE GOOD NEWS OF SALVATION TO THE WORLD

- **THE GENTILES RECEIVED IT (PROVOKING ISRAEL)**
- **BUT ISRAEL STUBBORNLY REJECTED IT**

INTRODUCTION:

Frank Thielman: The majority of those among Israel who have heard the gospel persist in their unbelief, despite hearing the good news of Israel's redemption from the messengers God has provided. God has sent people to proclaim the gospel in accord with Isaiah's prophecy that he would send messengers to proclaim Israel's eschatological redemption joyously.

Thomas Schreiner: Paul has just asserted that one must **call on the Lord** to be saved. In this paragraph he emphasizes that Israel had every reason to believe, and yet it was prophesied that they would fail to believe. **Verses 14–15** outline the steps necessary to facilitate calling on the Lord. The logical progression of thought is sketched in with a series of rhetorical questions. The culmination of the series is expressed in the first item—**calling on the Lord**, connecting to the claim in **verse 13** that one must call on the Lord to be saved. It follows, then, that the last item in the series (*being sent* in **v. 15a**) represents the foundational element in the logical train of thought that climaxes with calling on the Lord for salvation. . . . The point of the whole is that the messengers have been sent and the gospel has been proclaimed. The train of thought in the passage is interrupted by the claim in **verse 16** that not all have obeyed the gospel, but then in **verse 17** Paul reverts to the argument of **verses 14–15**, positing that faith comes from hearing and hearing through the message about Christ. The interruption in **verse 16** indicates that hearing the gospel is a necessary but not a sufficient condition for salvation. Even though the Jews have heard the gospel, they have not obeyed, just as Isaiah prophesied (**53:1**). Thus the main theme in **verses 14–17** is that Israel has not believed even though they have heard (**D. Moo** 1996: 662). **Verse 17** summarizes the flow of thought of the paragraph. Faith would not exist without hearing the gospel, and the word proclaimed is nothing other than the gospel of the crucified and resurrected Lord.

In **verses 14–17** Paul emphasizes that one must hear the message of the gospel in order to believe it and be saved. Paul stresses further that Israel has indeed heard the message of the gospel (**v. 18**), and the OT also predicted that the gentiles would be included in the people of God (**vv. 19–20**). Still Israel remains recalcitrant (**v. 21**).

Douglas Moo: The immediate jumping-off point for this paragraph is the quotation of **Joel 2:32** in **Romans 10:13**. This prophecy promises salvation for “*everyone who calls on the name of the Lord*.” In **verses 14–21**, Paul works back from this “*calling on the Lord*” to the steps that come before it: belief → preaching of the gospel → being sent to preach the gospel (**vv. 14b–15**). . .

Gentiles, who did not seek God, are finding him (10:20; cf. 9:30), while Israel, though offered God's grace, continues stubbornly to reject it (10:21; cf. 9:31–32). Although 10:13, then, is the immediate trigger for these verses, the paragraph ultimately picks up Paul's indictment of Israel from 10:2–3. Despite her zeal, Paul has charged, **Israel is guilty** of not understanding and submitting to God's righteousness in Christ, but **Israel has no excuse** for not responding.

Michael Bird: We should not underestimate the **missional theme** that runs through **Romans 9-11**. After all, the gospel is for the Jew first and then the Gentile (1:16), and **Romans 9-11** is about the gospel in relation to the story of Israel in past, present, and future. In the divine plan Jews and Gentiles have interlocking destinies since Gentiles get in on the coattails of Israel's covenantal promises (9:1-5; 11:18-25), Gentile inclusion will eventually prompt Israel to jealousy (10:19; 11:11, 14-15, 30-31), and in this way ethnic Israel and promissory Israel will both be saved (11:25-26). Paul's prayer for Israel's salvation (10:1) will one day come to fruition when God's call and love overpowers Israel's "*stumbling*," "*hardening*," and "*disobedience*" and leads them into his mercy (11:28-32).

Understandably then, Paul, as the Jewish Christian apostle to the Gentiles (see 1:1, 5, 13-16; 11:13; 15:18), takes a moment in 10:14-21 to place the Christian mission to both Jews and Gentiles on the map of prophetic promises. First, he places the mission in the coordinates of **Isaiah 52-53** and proceeds to describe the mission's urgency and the necessity of preaching the gospel for people to come to faith (**Rom 10:14-17**). Second, Paul pulls in parts of the Psalms, Deuteronomy, and Isaiah to lament Israel's failure to acknowledge that God had always intended to bring the Gentiles into salvation (10:18-21). This paves the way for Paul to argue in 11:1-32 that God is far from done with Israel since Israel's salvation is still on the cards as God will use the nations to provoke Israel to jealousy. Viewed this way, the primary issue is not Israel's failure, but God's mission to Jews and Gentiles and its surprising effects.

I. (:14-17) SALVATION DEPENDS ON FAITH RESPONSE TO GOSPEL PROCLAMATION

A. (:14-15) Causal Chain of Gospel Proclamation and Response

Frank Thielman: He had spoken of the simplicity of receiving salvation: it was available to anyone, whether Jew or Greek, who called upon the name of the Lord. Now he raises the question of whether those Jews who have rejected the gospel have actually received a fair chance of hearing, understanding, and embracing it. With his questions, Paul admits that for the Jews to call upon the Lord, the Lord must send heralds out with news of who he is, and they must communicate their message to the Jews, who must, in turn, believe it.

His quotation of **Isaiah 52:7** (cf. **Nah 1:15** [2:1 Heb. and LXX]) shows that God has provided all these requirements to his people. In its original context the passage was about God's redemption of his people from the oppression of their enemies and the establishment of peace, happiness, and salvation through the reign of God himself over them (**Isa 52:1–12**). Isaiah had depicted a herald running across the mountains surrounding Jerusalem to bring the good news of victory over their enemies to God's people. Isaiah understandably described the feet of such a welcome messenger as "*beautiful*" (na'wu; cf. **Song 1:10**).

Paul understood his own proclamation of the gospel, and that of the other apostles, to be the fulfillment of this prophecy.

Bob Deffinbaugh: Paul has said that even though God chooses those upon whom He will bestow the gift of salvation (**chapter 9**), men are responsible for their rejection of the gospel. So now we must go one step further. If the gospel is truly universal in scope, including both Jews and Gentiles, then it should be proclaimed universally. God is sovereign in the initiation and accomplishment of salvation, but man is responsible for its proclamation.

1. (:14a) Calling on Jesus Requires Faith

“How then shall they call upon Him in whom they have not believed?”

Some people have a Major Problem = “How can salvation depend on missionary outreach? Surely those who haven’t heard the gospel won’t be condemned.”

Assumption: “If Christ is the only way to God, and people cannot know Christ apart from missionary proclamation, then Christianity is invalid.”

Paul’s Response: “Wrong. Since Christ is the only way to God, and people cannot know him apart from missionary proclamation, then missionary work is essential.”

2. (:14b) Faith Requires Hearing the Gospel

“And how shall they believe in Him whom they have not heard?”

Grant Osborne: In the task of evangelism, an effective witness must include more than being a good example. Eventually, someone will have to explain the content, the what and the how of the gospel. Modeling the Christian life is important, but someone will need to make the connection between the mind of the unbeliever and the message of the gospel. There should never be a debate between those who favor **lifestyle evangelism** (one’s living proclaims the gospel) and **confrontational evangelism** (declaring the message). Both should be used together in promoting the gospel. Do people know of your faith by your actions? To whom can you communicate the life-changing message of Christ?

3. (:14c) Hearing Requires a Preacher

“And how shall they hear without a preacher?”

4. (:15a) Preaching Requires Sending

“And how shall they preach unless they are sent?”

“Sent” – verb form from which we get the noun “*apostle*” = to send on a mission with a commission; prefix “*apo*” – emphasizes “from, separation from the one sending you in terms of distance”;

the messenger has the full powers and is the personal representative of the one sending; there is a close connection between the sender and sent one;

119 of the 131 NT occurrences are in the Gospels and Acts.

5. (:15b) Preachers Commended

“Just as it is written, ‘How beautiful are the feet of those who bring glad tidings of good things!’”

Grant Osborne: In the verse quoted from **Isaiah 52:7**, the herald is bearing good news to Judah about the end of their exile in Babylon and their return to their own land. His feet were beautiful to them, for his good news was so welcome. The message was what he brought, but it was those worn and dusty feet that brought him. Those feet were beautiful because they represented the messenger’s willingness to be sent with good news. Only now the message was not just for Israel, but for the whole world.

B. (:16) Chink in the Chain = Failure of Jews to Respond in Faith

*“However, they did not all heed the glad tidings;
for Isaiah says, ‘LORD, who has believed our report?’”*

Frank Thielman: The expression “*not all obeyed*” uses the common rhetorical device, called **litotes** (λιτότης) or **meiosis** (μείωσις) in antiquity, which **deliberately understates the truth** “not to deceive someone but to enhance the impressiveness of what we say.” Here, then, Paul means that very few obeyed. . .

Paul’s quotation of **Isaiah 53:1 LXX** demonstrates again that Israel’s disobedient response to the gospel does not mean that the word of God has failed (**Rom 9:6**). Israel’s rejection of the glad tidings that Paul and other apostles were preaching in his own time corresponded in the apostle’s thinking to Israel’s rejection of the beautiful news of God’s redemption in Isaiah’s time (**Isa 52:7; 53:1**).

Thomas Schreiner: Supporting the notion that **most Jews have disbelieved** is the citation of **Isa. 53:1**, which conforms to the LXX almost exactly. It is likely that the larger context is in Paul’s mind here, since he has already cited **Isa. 52:7** in **Rom. 10:15**. **Isaiah 52:13–15** proclaims that gentiles will see and understand the message about the suffering servant of the Lord. Paul saw this text fulfilled in the gentile mission, where many accepted the message of the crucified Christ. But **the Jews stumbled**—as Paul did before his conversion—at the message of a crucified Messiah (cf. **1 Cor. 1:23**), concluding that it was scandalous to identify one cursed of God as the Messiah (**Deut. 21:23**). Thus they did not believe the report of the apostolic preaching. We also see here the **inseparable relationship between faith and obedience**, a relationship noted with the phrase “*obedience that flows from faith*” in **Rom. 1:5** (cf. **16:26**). The parallelism between ὑπήκουσαν (*he obeyed*) and ἐπίστευσεν (*episteusen, he believed, 10:16*) demonstrates that the Pauline concept of faith always involves commitment and submission to the lordship of Jesus (cf. **10:9**). For Paul, faith is not merely verbal assent but also entails a wholehearted commitment to God.

John Schultz: Nobody in Israel understood the purpose of Jesus’ suffering and death, although the whole Old Testament testified to it. The two men who walked to Emmaus on the day of Jesus’ resurrection voiced the general feeling of all the disciples when they said: “*He was a prophet, powerful in word and deed before God and all the people. The chief priests and our rulers handed him over to be sentenced to death, and they crucified him; but we had hoped that he was the one who was going to redeem Israel. And what is more, it is the third day since all*

this took place.” They all thought they had been wrong. We read Jesus’ answer in Luke’s Gospel: “He said to them, ‘How foolish you are, and how slow of heart to believe all that the prophets have spoken! Did not the Christ have to suffer these things and then enter his glory?’ And beginning with Moses and all the Prophets, he explained to them what was said in all the Scriptures concerning himself.” It was not until “He opened their minds so they could understand the Scriptures” that the light began to dawn

C. (:17) Connection between Faith, Hearing and Proclamation of the Gospel

“So faith comes from hearing, and hearing by the word of Christ.”

Frank Thielman: “*The word of Christ*” (ῥήματος Χριστοῦ) is an objective genitive construction describing the word that Paul and the other apostles preached about Christ. It is identical to “*the word of faith*” that according to **10:8** Paul and his coworkers preach and that, like the word of

God described in Deuteronomy **30:14**, is easy to appropriate. Just as in Isaiah’s time, however, many within Israel have failed to heed this lovely and easily obeyed message.

Thomas Schreiner: Paul presumably inserted the verse to sum up and emphasize what he stated in **verses 14–15**. . . The message about Christ centers on his death and resurrection, which are communicated in **Isa. 53**. The inbreaking eschatological salvation that is proclaimed by God’s messengers (**Rom. 10:15; Isa. 52:7**) focuses on God’s Son, who has inaugurated the age to come by virtue of his death and resurrection. Thus the saving proclamation of the gospel always involves the proclamation of Jesus as Lord, who died for our sins and was raised from the dead (cf. **Rom. 4:25; 10:9–11; 1 Cor. 15:1–4**). . .

We have already seen that Paul doesn’t contemplate the possibility that people will be saved by responding positively to natural revelation. All people without exception reject the revelation of God heralded in nature and turn to idolatry. **Romans 10:14–17** verifies this interpretation, since it excludes the idea that salvation can be obtained apart from hearing the gospel.

Grant Osborne: This statement expresses the main theme of this section. People need to hear the Good News of salvation in Christ in order to believe it (**10:14**). Faith does not respond in a vacuum or respond blindly. Faith is believing what one has been told about God’s offer of salvation and trusting the one who has been spoken about.

II. (:18-20) NO EXCUSES FOR JEWISH REJECTION

A. (:18) Jewish Rejection Cannot Be Blamed on Lack of Revelation

“But I say, surely they have never heard, have they? Indeed they have; Their voice has gone out into all the earth, And their words to the ends of the world.”

Grant Osborne: Some might argue that the Jews weren’t given enough chances to hear or that somehow the message should have been made clearer for them. Perhaps Isaiah’s complaint (“*Who has believed?*” **10:16**) was the fault of the messenger. But Paul emphatically responds that **of course** they heard. The message had been preached far and wide, first to the Jews and then to the Gentiles (see **1:16**). . .

As the loopholes close for the Jews, they close for everyone else, too. If the Jews are not excused for their unbelief, how can the rest of us think there might be some excuse for us? In the end, some may wish they had heard more, but God will declare that what they heard was enough. In the meantime, those of us who have heard have little excuse for our apathy in passing on the Good News!

Frank Thielman: This counterproposal itself uses the voice of **Psalm 19:4** (18:5 LXX; 19:5 Heb.), although Paul does not introduce it as a quotation of Scripture. He is probably recalling the language of the psalm and its broad claim that God is not a hidden and mysterious being but has revealed himself to everyone (cf. **Rom 1:19–20**). What the psalm says about creation Paul says about the proclamation of the gospel. Both are God’s revelation of himself, and both have made him known on a **wide scale**. Paul was under no delusion that every Israelite had heard the gospel. Like the psalm, he is speaking poetically rather than with scientific precision and is making his point by means of **hyperbole**.

As Theodoret of Cyrus observed in the fifth century, Jesus himself had sent his apostles first to “*the lost sheep of the house of Israel*” (**Matt 10:6**), and Acts regularly shows Paul going first to the Jews (e.g., **Acts 13:46**). Paul’s point, then, is that in the wide proclamation of the gospel (cf. **15:19**), the Jews have hardly been neglected.

Thomas Schreiner: One should not press Paul’s words inordinately here. The purpose is not to say that all missionary work has been accomplished, for as **Rom. 15:24** demonstrates, Paul had plans to evangelize Spain (**Cranfield** 1979: 537). What these words indicate is that the mission has been extended to include gentiles (cf. **Col. 1:23**). God’s general revelation thus functions as a type and anticipation of the gospel message, which extends to all peoples. . .

the meaning of **10:18** can be summarized briefly. Paul affirms that Israel has certainly heard the gospel. The proof of this is that the gospel has even been proclaimed to the gentiles. If the gospel has been proclaimed to the gentiles—in fulfillment of the OT prophecies that the kingdom of God would encompass the whole world—then the **age of fulfillment** has dawned, and Israel has certainly heard the good news that Isaiah (**52:7**) foretold would be proclaimed. Of course, Paul isn’t claiming that every single Israelite has heard the good news, and thus the statement here is **hyperbolic**.

B. (:19-20) Jewish Rejection Cannot Be Blamed on Any Hidden Agenda Regarding Gentile Inclusion

1. (:19a) No Surprises in God’s Agenda for Gentile Inclusion

“But I say, surely Israel did not know, did they?”

2 OT quotations in support of this contention – Moses and Isaiah

Thomas Schreiner: What Israel knew from the OT was that the gentiles would be included within the circle of God’s saving purposes and that Israel would resist his saving work. Thus the Jews can level no objection against Paul’s gospel because it is more successful among gentiles than

Jews. Paul insists that **this state of affairs was predicted in the OT** and was known or should have been known to the Jews.

Douglas Moo: Having demonstrated that Israel has heard, Paul now wants to probe more deeply into the nature of this “hearing.” **Was it superficial?** Not at all. Israel, Paul affirms, understood. What they understood is that God could very well act in such a way as to include Gentiles in his people and to bring judgment on his own people Israel (vv. 19–21). Moses, Paul suggests, was the “*first*” in a long line of prophets to suggest that God would eventually extend his grace beyond the confines of Israel. Those who are “*not a nation*” (cf. “*not my people*” in 9:26) will stir up Israel’s jealousy, predicts Moses in **Deuteronomy 32:21**. Paul announces a theme he will take up later to explain the oscillation in salvation history between Jew and Gentiles (11:11–14).

John MacArthur: Now that's the theme of **Romans 10, self-imposed ignorance**. They were ignorant. It wasn't that they didn't have the truth. It was they rejected the truth. It wasn't that it was not available to them. It was that when it was available they refused to see it. And they cultivated a kind of blindness from which they never could extract themselves.

Now in the tenth chapter of Romans then, Paul is dealing with the whole matter of **Israel's blindness**. He is dealing with the fact that they have missed the Savior, they have missed the Messiah, they've missed the Lord Jesus Christ and they've done it because of their tremendous ignorance, tremendous ignorance.

2. (:19b) Gentile Inclusion Prophecied -- Intended to Provoke Israel to Jealousy

“At the first Moses says, ‘I will make you jealous by that which is not a nation, By a nation without understanding will I anger you.’”

Thomas Schreiner: In **Deut. 32:21** is a specific prediction that Israel would be stirred to jealousy by a foreign people. The provocation of the Jews to jealousy by the gentiles figured largely in Paul’s estimate of salvation history, as **Rom. 11:11, 14** demonstrate. From the latter verses we know that the jealousy and anger incited in Israel has a **salvific consummation**, according to Paul, but such a theme is not yet necessarily present in **10:19**, since being provoked to jealousy here is parallel with being angered.

3. (:20) Gentile Inclusion Prophecied -- Due to God’s Gracious Sovereign Election

“And Isaiah is very bold and says, ‘I was found by those who sought Me not, I became manifest to those who did not ask for Me.’”

Frank Thielman: Testimony that Israel has understood the gospel comes not only from Moses but from Isaiah who speaks of God’s willingness to make himself known even to those who are not seeking him. God has done this in the case of gentiles who have heard the gospel, and some of them have believed. If God makes the gospel clear even to gentiles, who know nothing of his ways, then surely unbelieving Israel, with its advantage of God’s revelation in Scripture, has understood the gospel.

Thomas Schreiner: In **10:20** the point is that God has revealed himself to those who did not seek him or ask for him. In both **9:30** and **10:20** the electing work of God is the decisive reason for

the inclusion of gentiles. It would be a mistake, then, to conclude that the strong emphasis on election in **chapter 9** is jettisoned in **chapter 10**.

Steven Cole: By Isaiah's boldness, Paul is referring to the astonishing nature of God's grace. He pursues and saves those who were not seeking after Him, but were content in their pagan ways! This shows that salvation is not due to a good streak in sinners, but totally to **God's sovereign grace**. If you are a believer in Jesus Christ today, it is not because it was originally your idea to seek Him and find Him. Rather, He intervened in your life to reveal Himself to you. His Spirit convicted you of sin and showed your need for the Savior. He moved in your heart to respond in faith to the gospel.

III. (:21) SALVATION STUBBORNLY REJECTED BY REBELLIOUS ISRAEL

A. Persistent Reaching Out to Israel with Gospel Invitation

"But as for Israel He says, 'All the day long I have stretched out My hands'"

B. Persistent Rebellion by Stubborn Israel

"to a disobedient and obstinate people."

Frank Thielman: Just as God's merciful appeal to recalcitrant Israelites provides an analogy to his merciful approach to foolish gentiles, so Israel's stubborn refusal to obey God in Isaiah's time provides an analogy to their unbelief and opposition to the gospel in Paul's experience. . .

In **10:20–21**, then, Paul returns to the picture with which he began in **9:30–31**. Gentiles who neither pursued righteousness nor sought after God have found God and the righteousness he gives. Many within Israel, however, despite having the Scriptures and a zeal for God, have not submitted to God's righteousness and remain disobedient to the gospel. By the time Paul reaches the end of this section, he has demonstrated that Israel's own Scriptures anticipated this turn of events, however surprising it might be.

John MacArthur: Why did the Lord reject Israel and turn to the Gentiles? Because all day long He stretched forth His hands to a disobedient and opposing people. He couldn't get them to respond. "*Disobedient*" literally means to refuse to believe, to refuse to believe. They refused to believe Him. "*Contrary*" or "*opposing*" literally means to deny or to speak against, *antileg*, to speak against, to contradict. And so, God says you were ignorant of your Scriptures. If you had known the prophecy of Moses and you had known the prophecy and the words of Isaiah, you would have known that the day would come when Israel would be rebellious and I would reach out to the nations. I would go beyond you to provoke you to jealousy. And when that happened... This is what he's saying: When that happened, when Israel didn't believe and Jesus started reaching to the Gentiles and when the church went out to the Gentiles, a thinking, knowledgeable, believing Jew who understood his Old Testament should have said to himself, "This is that which was spoken by the prophets. It's happening. Therefore this is the Messiah and this is the true message." They should have concluded that. "*All day long*" means patiently and continually. "*Stretched forth My hands*" means lovingly to embrace you, to welcome you to intimacy and to security. A loving God has reached out to these people again and again and again and they have resisted in disobedience.

Bob Deffinbaugh: The sum and substance (v. 21). Israel is without excuse for her unbelief. It is not so much a matter of ignorance, but of obstinance. It is not so much a matter of misunderstanding, but of disobedience. Here is Israel's real problem, obstinance and disobedience.

Grant Osborne: Finally, from **Isaiah 65:2**, Paul explains that God had been gracious to his people, patiently holding out his hands to them and calling them, only to have them turn away. That God *held out his hands* to his people indicates a gesture of dual purpose: one of welcome and of giving. But God's welcome was spurned and his gifts were rejected.

The disobedience of Israel was judged by God's welcome to the Gentiles (even though that was in his plan all along). But he will still accept his chosen people if they will only return to him. He remains faithful to his promises to his people, even though they have been unfaithful to him. God still holds out his hands.

Douglas Moo: In **10:21** Paul finally turns back to the **failure of Israel**, the issue that has dominated this section. He quotes **Isaiah 65:2** to make two points:

- God continues to extend his grace to Israel (he "*holds out his hands*" to them),
- and Israel continues to rebel (they are "*disobedient and obstinate*").

Michael Bird: Whereas Paul thinks that **Isaiah 65:1** refers to Gentile inclusion, he understands **Isaiah 65:2** as putting Israel back in the spotlight, or we might say "shame light": "But concerning Israel he says, '*All day long I have held out my hands to a disobedient and obstinate people*' " (v. 21). Israel is in that position because, as Paul said back in **9:30-33**, they are pursuing righteousness by Torah with the result that they have not attained their goal. They have stumbled over the messianic stone and tried to establish their own righteousness. Instead of being the renewed people of God who herald the message of God's mercy to the nations, Israel has become stubborn and recalcitrant to what God is doing for the nations through the Messiah.

DEVOTIONAL QUESTIONS:

- 1) How would you respond to Christians who emphasize only lifestyle evangelism and shy away from aggressively proclaiming the message of the gospel?
- 2) How did the Jews of the first century react to the composition of the new church being largely Gentile?
- 3) Is your church devoting enough resources to sending missionaries to unreached peoples?
- 4) How does this passage demonstrate the patience of God towards Israel and undermine the view that God no longer has a future plan for Israel as a nation?

QUOTES FOR REFLECTION:

5 Stages in God's Program for Sending Gospel Missionaries:

I. OT Prophecy

Is. 61:1; Luke 4:13-30

Relates to the Servant of the lord = the Messiah;

If Jesus as the Son of Man needed the ministry of the Holy Spirit to be effectual, how much more do we!

2 incidents from OT Jewish history cited to demonstrate the principle that God is not exclusively only interested in Israel:

- Elijah the prophet was rejected by His people, but brought blessing to a Gentile woman
- Elisha also was sent by God to bring special blessing to a Gentile, Naaman

Many people are like the Nazarenes. Jesus is familiar to them. They ascribe beauty and wisdom to selected teachings of His, but they will not recognize and submit to Him as the eternal Son of God and their Saviour.

II. Ministry of John the Baptist

Sent as a forerunner to prepare the way for the coming of the Lord;

Mal. 3:1; 4:5 (Is. 40:3)

OT prophecies view the two comings of Christ as a simple unity (should cause us to hesitate making simplicity one of the key criteria in interpreting NT prophecies relating to Christ's Self-righteous Jews wanted to see their Covenant God come in Judgment and stamp out their enemies; the people were disillusioned because their self-righteousness had blurred the distinction between the righteous and the wicked.

God points out their need for repentance and a changed heart – lays out very specific charges against His people in Malachi:

- They failed to appreciate the love of God
- They failed to respect the name of God
- They called the service of God drudgery
- They undermined the authority of God's Word
- They failed to preserve the holiness and unity of marriage
- They failed to anticipate the coming judgment of God
- They failed to obey God's commands – robbing Him of tithes and offerings

They certainly needed some spade work done in their hearts to prepare them for the gospel; the proper foundation for the gospel is to dig up and expose the roots of self-righteousness (**3:13-15**)

- Pride in maintaining their own innocence (:13)
- Deception regarding what God requires (:14)
- Bitterness in denying God's justice (:15)

Ministry of John the Baptist – 1:6; 3:28

III. Ministry of Christ Himself on Earth (passages from Gospel of John)
3:17, 34-36; 5:36-38; 6:29, 57; 7:29; 8:42; 10:36; 11:42; 17:3, 8, 18, 21, 23, 25; 20:21

1 John 4:9-14

IV. Ministry of the Apostles
Following the Great Commission

V. Ministry of the Local Church – beginning with Antioch (**Acts 13:1-4**)

4 Characteristics of a Missionary Sending Church:

- 1) Diversified Teaching Ministry based on spiritual gifts rather than monopoly of teaching ministry by one key leader
- 2) Focused Devotion on the Lord in Worship and Spiritual Disciplines –
Cf. fasting and seeking the Lord's will;
- 3) Sensitive to the Leading of the Holy Spirit; not selfishly holding on to what they had
- 4) Identification and Partnership in the missionary task

Douglas Moo: Romans 10:14–21, in the context of Paul's life and theology, teaches that response to God's Word is the only way to salvation and that sending out people to proclaim that word is God's chosen way to bring that Word "to the ends of the earth." The twenty-first century church needs to embrace this theology and staunchly defend it against the many attacks that are sure to increase. We need also to translate that theology into practice so that the sending of missionaries can again take top priority in the life of the church. Too many churches spend far too much on themselves and far too little on missions. We so easily turn inward and become preoccupied with our problems and potential, neglecting the millions who have never heard the Word and the wonderful potential to bring God glory by showing them the way into the kingdom.

John Toews: The text unit opens with a series of rhetorical questions that build on the Joel citation in v. 13. The *calling on the Lord* theme permits Paul to explain the rejection of Israel in the most explicit terms so far, and also to offer an interpretation of the Christian mission to the world. Christian confession requires trust, which necessitates hearing, which cannot occur without preaching, which presupposes the commissioning of the preacher. The sending forth of many proclaimers is a magnificent end-time event, as prophesied by Isaiah (52:7).

The great tragedy of history is that *not all obeyed the gospel*. *Not all* here stands in contrast to *all* in vv. 11-13. The gospel is for all without distinction, but not all obey. Obedience is defined as the appropriate response to the gospel in continuity with the letter's opening and closing call for the *obedience of faith*. The unbelief of many is not surprising; Isaiah predicted it in describing the destiny of the Suffering Servant. **Verse 17** introduces a conclusion (*therefore*) which

summarizes the gospel. The source of trust is hearing, and what is heard is the *word about the Messiah*.

Verse 18 poses the second critical question. Is the disobedience of many due to not hearing the gospel? The negative answer is supported with a citation of Scripture (**Ps. 19:4**). The Christian mission has taken the gospel to the world. The third question, v. **19**, becomes people specific. Paul has not named Israel so far in this discussion of disobedience to the gospel. As in **9:31**, he now specifically names **Israel**. The issue is who constitutes the new people of God? If the gospel has gone to the world, is the problem of Jewish rejection due to Israel not understanding? Paul answers with three Scripture citations.

Steven Cole: Why Some are Lost and Some are Saved

It's staggering! God sends messengers with the best news in the world, that God is ready to pardon any sinner who will receive His offer of grace and kindness. Not only that, but God paid a great price to provide this pardon. As Isaiah 53 goes on to reveal, He sent His Messiah, the suffering servant, who would be "pierced through for our transgressions," and "crushed for our iniquities." "All of us like sheep have gone astray, each of us has turned to his own way; but the Lord has caused the iniquity of us all to fall on Him" (53:5, 6). But a suffering servant didn't fit with Israel's idea of a Messiah. They wanted a conquering king to defeat all their enemies and provide a comfy life for them. They didn't like all this talk about them being sinners who needed a Savior to die in their place. So they slammed the door on the best news in the world. . .

Because of disobedient, hard hearts, many do not believe the gospel and are lost; others believe the gospel and are saved because of God's sovereign grace.

What makes the difference? I'm going to state what the Bible plainly teaches, although I cannot explain how both statements are true: *If someone is saved, it is totally due to God choosing him before the foundation of the world, effectually calling him to Christ, and saving him by His grace alone (Rom. 8:30; 9:11-23). If someone is lost, he is totally responsible for his disobedient, hard heart that rejects God's grace (10:21; Prov. 1:24)*. In other words, if you believe in Christ, it is only because God had mercy on you. If He had not intervened, you would still be in your sins, headed for eternal judgment. But if you do not believe in Christ and reject His gracious offer of salvation, you are completely to blame. You cannot blame God for not choosing you. Your sinful unbelief is totally your own fault. . .

MANY KNOW GOD'S WAY OF SALVATION, BUT THEY STILL REJECT THE GOSPEL (10:19). . .

In the context, Moses predicted Israel's apostasy through idolatry. The full verse reads (**Deut. 32:21**), "*They have made Me jealous with what is not God; They have provoked Me to anger with their idols. So I will make them jealous with those who are not a people; I will provoke them to anger with a foolish nation.*" Paul is applying this to the spread of the gospel among the Gentiles, which he will expand on in **11:11-14**. Just as Israel provoked God to jealousy and anger by their idolatry, so God will provoke Israel to repentance and faith when they jealously see those whom they would despise as being a "no-nation" or "a foolish nation" coming to know God. This means that in His grace, God is not through with Israel, in spite of her unbelief and sin

(Romans 11 develops this theme).

What is it that Israel did not know?

- In **verses 19 & 20** it is that the gospel would go to the despised Gentiles.
- In **verse 21**, it is that most of the Jews would reject the gospel in spite of God's kindness and patience.
- Going back to **verses 11 & 13**, it is the gospel itself.

All of these verses are quotes from the Old Testament, which shows that Israel should have known all of these things through reading their own Scripture. Paul wasn't making them up.

John MacArthur: So it's a profound message in **chapter 10**. Israel is lost. Israel is set aside. Israel is excluded from salvation as a nation, though as I said, individual Jews in all ages have believed and been God's remnant. And God has gone beyond to touch the church made up of all peoples, tongues and nations. Why was Israel lost? Now listen as I just pull this together. Because they were ignorant of God's person, because they were ignorant of the provision of Christ, they were ignorant of the place of faith, they were ignorant of the proportions of salvation, they didn't want to get into something that wasn't exclusively for them, and they were ignorant of the predictions of Scripture. They should have been able to see that this was it when they charted what happened from their own unbelief. What a tragedy.

Now, is this ignorant unbelief of Israel permanent? Is it? Is it permanent? The answer to that question comes in **chapter 11** and the answer is what? No, and we're glad for that.

Michael Bird: The Gentile Christians in Rome, who probably did not get the complete significance of all of Paul's Old Testament citations, would nonetheless probably have had an "aha" moment after hearing **Romans 9-10**. Careful reflection on these words would provide them with a better grasp of why most Jews have rejected the message and how this relates to God's purposes to bring Gentiles into the inheritance of Israel. But they might ask, does that mean that God has now rejected Israel (**11:1**), that Gentile believers can consider themselves to be superior to Israel (**11:18**), or that Israel can be regarded as the dead wood pruned off a tree to make room for them (**11:19**)? Paul will give an emphatic "no" to all these questions. But, to be fair, after reading **Romans 9-10**, it certainly looks as if Paul is giving Israel a hard time for their failure to believe, and he even leaves their position before God up in the air.

Yet Paul only emphasizes Israel's failure at such length so that Israel's salvation will appear all the more striking. Israel's reconciliation will serve to magnify the depths of God's mercy and the constancy of God's faithfulness toward Israel (see **11:33-36**). Keep in mind that there is still another chapter of the story to be told. After telling his version of Israel in the past, after narrating the tragedy of Israel in the present, Paul will now go on to tell a story of hope for Israel in the future.

Leedy Greek NT Diagrams:

Rom 10:14

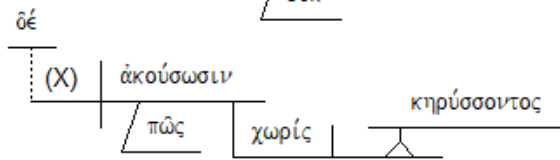
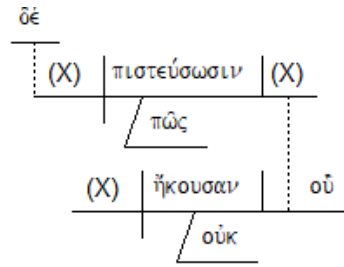
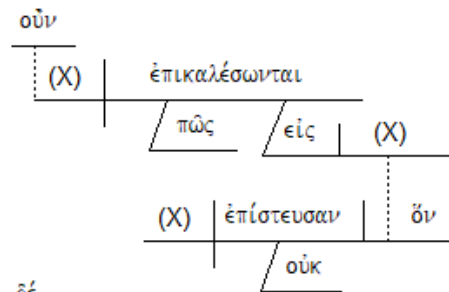

Rom 10:15

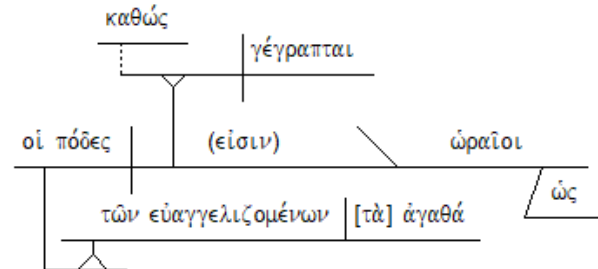
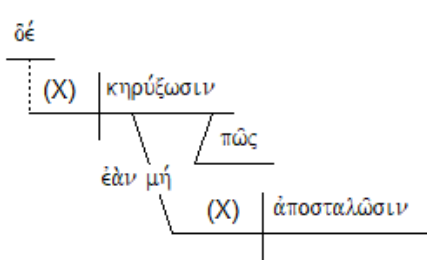

Rom 10:16

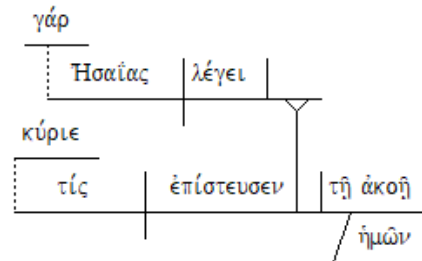
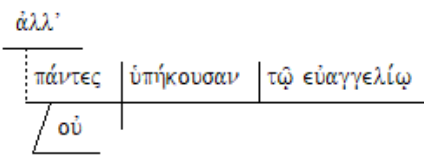

Rom 10:17

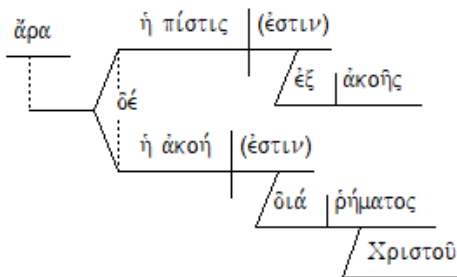

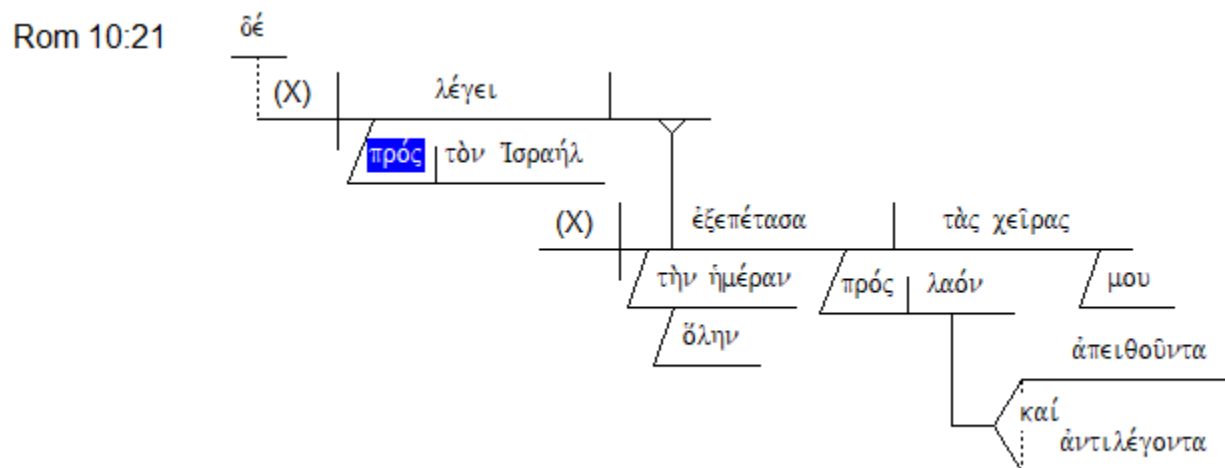
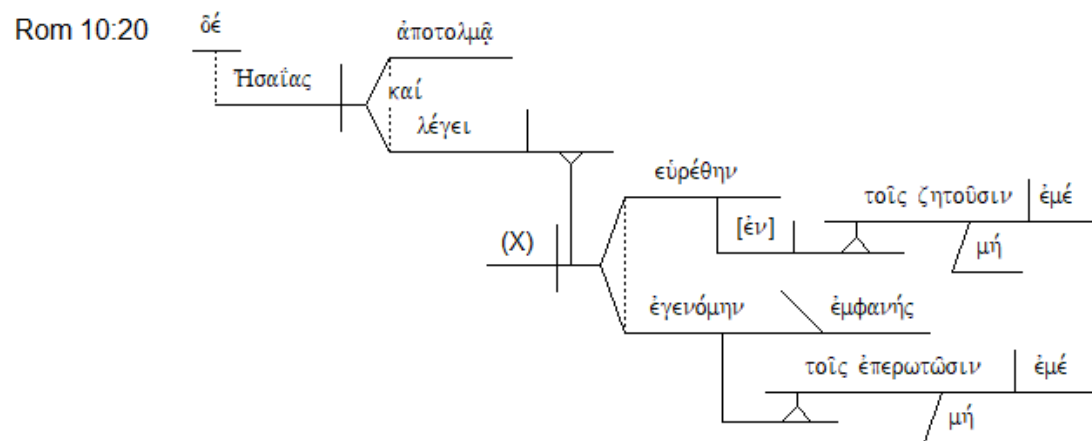
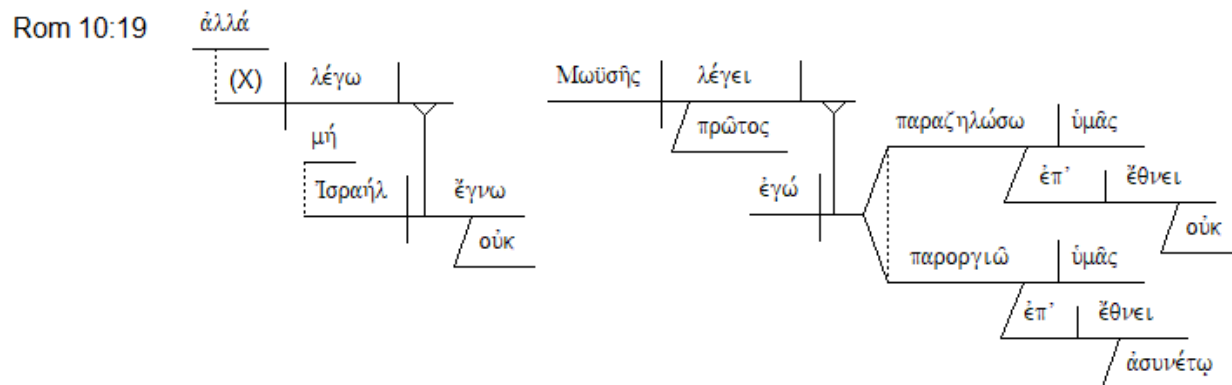
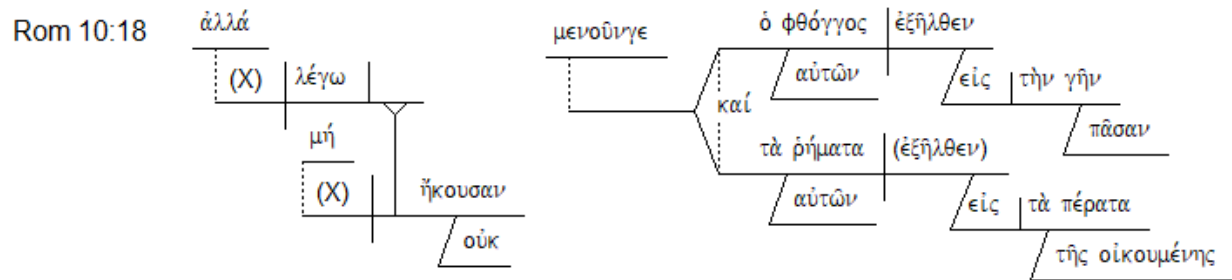

Frank Thielman:

- 14a Rhetorical Question **How, then, should they call upon him whom they have not believed?**
- b Rhetorical Question And **how should they believe him whom they have not heard?**
- c Rhetorical Question And **how should they hear without a preacher?**
- 15a Rhetorical Question And **how should they preach unless they are sent?**
- b Verification (of 15a) Just as it is written,
"How beautiful are the feet of those who proclaim ☞
good news." (Isa 52:7)
- 16a Contrast (to 15b) But **not all have obeyed the gospel.**
- b Verification (of 16a) For **Isaiah says,**
"Lord, who has believed our report?" (Isa 53:1)
- 17 Inference (of 16b) So, **faith comes**
from hearing, and
hearing
through the word of Christ.
- 18a Rhetorical Question But, **I say, they didn't fail to hear did they?**
- b Assertion/
Verification To the contrary!
"Their voice went out to all the earth and
c Restatement (of 18b) their words to the limits of civilization." (Ps 19:4)
- 19a Rhetorical Question But, **I say, Israel didn't fail to understand did it?**
- b Assertion/
Verification **First, Moses says,**
"I will make you jealous of those who are not a people, and
c I will make you resent a foolish people." (Deut 32:21)
- 20a Assertion/
Verification And **Isaiah dares to say,**
"I have been found among those who do not seek me,
b Restatement I have become visible to those who do not ask for me." (Isa 65:1)
- 21 Contrast (to
19b–20b) But **to Israel he says,**
"All day long I have stretched out my hands to a disobedient and ☞
oppositional people." (Isa 65:2)

TEXT: ROMANS 11:1-10

TITLE: ISRAEL: DOWN BUT NOT OUT – A REMNANT STILL EXISTS

BIG IDEA:

GOD'S REJECTION OF HIS CHOSEN NATION ISRAEL HAS NEVER BEEN TOTAL

INTRODUCTION:

R. Kent Hughes: In this chapter Paul concerns himself with the question of whether God has given up on Israel. It was a natural question because much of the nation was spiritually lost in Old Testament times, and likewise the bulk of the nation rejected the Messiah when he came. Paul's answer here will be that God is in no way done with the Jews—there is a future for the Jewish nation. This answer, as we shall see, carries with it some advice on how we are to regard the Jews.

Frank Thielman: So far in **Romans 9–11** Paul has argued that **Israel's rejection of the gospel does not mean the failure of God's word** for two reasons.

- First, Scripture itself shows that God has always decided who would belong to his people. If more gentiles than Jews currently fill their ranks, then this only shows that salvation comes to people at God's initiative (**9:1–29**).
- Second, he has demonstrated that despite God's sovereignty over who belongs to his people, Israel itself bears responsibility for rejecting the gospel, and their disobedience is consistent with the disobedience of Israel so often described in Scripture (**9:30–10:21**)

So far, then, Paul has shown that God's relationship to the Israelites who have rejected him is not inconsistent with the portrait of God's relationship to his people in Scripture, and he has gone a long way toward successfully defending his thesis that "*the word of God has not failed*" (**9:6**).

Still, the argument so far has not demonstrated how the current situation of Israelite unbelief can be consistent with God's promises of faithfulness to Abraham's physical descendants. God may be justified in placing within his people anyone he chooses, and he may be just in punishing those who have rebelled against him, and all this may be consistent with his approach to Israel in Scripture. Yet in Scripture God promised to be faithful to the Israel defined not merely in spiritual terms but in physical terms also, and in Scripture he is merciful to this particular ethnic group even when they rebel against him.

The final step in Paul's argument, then, shows that God is both merciful to physical Israel in the present (**11:1–10**) and in the future will continue to be merciful to them (**11:11–32**). Each of the two sections begins the same way rhetorically. A rhetorical question suggests an idea that Paul emphatically rejects and then follows with a thesis statement describing the essence of what he is about to argue. . .

In **11:1–10** Paul shows that in the present there is a remnant of Israelites whom God has graciously chosen to attain righteousness through faith in the gospel (**11:1–6**) despite God's hardening of the rest of Israel (**11:7–10**). The section explores the idea of the salvation of a

“*remnant*” (λεῖμμα, v. 5; cf. ὑπελείφθην, v. 3) that Paul had mentioned in passing in the set of scriptural quotations that ended the first major section of his argument (9:27, ὑπόλειμμα; 9:29, ἐγκατέλιπεν). . .

Main Idea: Paul argues that the remnant of those within physical Israel who have received God’s grace and attained righteousness demonstrates that even in the present situation God has not rejected his people. The imbalance between Israelite believers and unbelievers in the present differs little from the situation described in Scripture. In Elijah’s time a remnant existed who had not abandoned God to worship Baal, and in David’s time there were unjust Israelites, like those who in more recent days had rejected Jesus and persecuted his followers. Once again Paul shows that God’s word has not failed (9:6) because the present situation is consistent with what Scripture says about God’s approach to physical Israel.

S. Lewis Johnson: Now, after the apostle has said that, he still wants to answer the question that is lying at the bottom of all of this, **What about Israel?** And in **chapter 11** he makes two points, they are very simple points. **Israel’s failure is not total**. We should never forget that. It is not that all Israel has been set aside now. There are Israelites who are being saved. There are Israelites who are in the company of the Gentiles, who are in the church of God. There is a remnant according to the election of grace. And finally, he makes the point that **her failure is not final**. There is coming a time when all Israel shall be saved the promises of the Old Testament are to be fulfilled. **Robert Louis Stevenson** once wrote, “I cannot understand how you theologians and preachers can apply to the church—or multiplicity of churches—Scripture promises which, in their plain meaning apply to God’s chosen people, Israel, and to Palestine; and which consequently must be still future. The prophetic books are full, of teachings which, if they are interpreted literally, would be inspiring, and a magnificent assurance of a great and glorious future; but which, as they are spiritualized, becomes farcical—as applied to the church they are a comedy.”

John Schultz: The question remains whether apostate Israel can still be considered God’s chosen people, or whether only Messianic Jews fall into that category. The answer to this is pertinent in our time, since most Israelis who presently live in the land of Israel are either Judaist or atheist. Some Christians blindly accept all present-day Israel does as legitimate because they are still considered God’s chosen people, regardless of the morality of their acts.

On the other hand, some Christians maintain that the church has replaced Israel of old as God’s chosen ones and that Israel has irrevocably lost its privileged status with God. This chapter of Romans seems to contradict the extreme of both views.

John MacArthur: Now, the question of God keeping those promises is a bigger question than just dispensational debate. The question of God keeping those promises is a **question of divine integrity** because if God has obviated, cancelled, changed His promises to Israel, we’re all in a lot of trouble because we have a God who can’t be trusted and who may as readily change His promises to us as He did to them. Now that’s the bottom line consideration in understanding what’s before us in this chapter.

Israel's very existence as a nation is tied to the promises of God without question. In fact, they were elected by God as His chosen nation and by His own sovereignty, unconditionally, He promised to bless them. The blessing that came to them in the Abrahamic covenant was not even conditioned upon them. In other words, God determined to do it no matter what they did. God would bring about the right circumstances to fulfill His promises. So God chose a people, God made promises to a people, God confirmed those promises by an oath in the fifteenth chapter of Genesis. He made the promises in **chapter 12, chapter 13**, and then in **chapter 15** He confirmed it by an oath. He had animals cut in half, which was the old way of making an oath; the pieces laid on two sides and two birds killed and laid on each side. And then He, as a smoking furnace and a burning lamp, passed between those pieces, covenanting with Himself, swearing by Himself, making an oath to Himself that He would keep His promises. So you have divine covenants based on sovereign election confirmed by a divine oath and that is why **Hebrews 6 verses 13 to 18** says God has made His covenants and confirmed them by an oath by which He swore to keep His covenants. And so **God has made promises to Israel which He must keep.** . . .

Some have concluded, therefore, that because Israel rejected the Messiah, God cancelled out all His promises to them. God just erased the blackboard. The promises were written in chalk and when that happened, took out His big eraser and just wiped them off. That's the end of promises to Israel. And many teach today that God then has obliterated all of His covenant promises to Israel and they are now spiritually being fulfilled in the church and we are the new Israel who receive all of the literal promises to Israel spiritually. We are the Israel of God, they tell us. And as far as the nation is concerned, they're out, the promises have been cancelled. . .

I hope that when we're done you'll have a tremendous affirming sense of the **trustworthiness of God who is a covenant-keeping God**. You see, Paul must defend the fact that God has not cancelled His promises to Israel, because how are you going to get any Gentile to accept the gospel from a God who cancels out His promises?

First of all, Israel's setting aside because of their unbelief, because of God's sovereign plan, Israel's setting aside — mark it now — is only, first of all, partial. It's only partial. Not all Jews are set aside, it's only partial. Secondly, it's only passing, it's only passing. It's only temporary. Thirdly, it is purposeful and that is the most marvelous part of the chapter. **It is partial. It is passing. It is purposeful.** It is partial, goes from **verse 1 to 10**. It is passing, from **verse 11 to 25**. It is purposeful, from **26 to 36**. So the theme of the chapter is very clear, Israel will be restored, Israel will receive fully the promises and that's why the chapter ends with praise in **verses 33 to 36**. Their setting aside is only partial, not all of them; only passing, not permanent; and purposeful, in other words, it has purpose, it has a goal, it has an object, it has a reason. And it's just thrilling as we go through these things.

Douglas Moo: The center of the first paragraph is **verse 5**: “*So too, at the present time there is a remnant chosen by grace.*” Paul leads up to this assertion by citing the evidence of his own Christian commitment (**v. 1b**) and the Old Testament (**vv. 2b–4**) for God’s preservation of a remnant. He follows up his central claim by elaborating on grace (**v. 6**) and then, reiterating his argument from **9:6–29**, concludes by showing how Israel’s present condition is the result of God’s sovereign choice (**vv. 7–10**).

Grant Osborne: In this section Paul points out that not all Jews have rejected God’s message of salvation. He draws upon the experience of Elijah to show that there had always been a faithful remnant among the people. In Paul’s day, there was still a remnant living by faith, under the law (11:5). After all, Paul was a Jew; so were Jesus’ disciples and nearly all of the early Christian missionaries. Part of God’s sovereign choice involves bringing a remnant of his people back to himself. This truth forbids any hint of anti-Semitism—**God’s plan still includes the Jews.**

I. (:1-6) GOD’S GRACE HAS PRESERVED A REMNANT IN ISRAEL

A. (:1a) Key Question: Has God Rejected Israel Completely and Permanently?

“I say then, God has not rejected His people, has He?”

Frank Thielman: Paul may have especially had in mind the context of **1 Samuel 12:22** where, after Israel had “*rejected . . . God*” by asking for a king (**1 Sam 10:19**), they worried that God would punish them with death (**1 Sam 12:19**) and asked Samuel to intercede for them with God. Samuel responds, “*Do not be afraid. . . . For the Lord will not cast away [ἀπόσεται] his people for his great name’s sake, because the Lord graciously took you to him for a people*” (**1 Sam 12:20, 22 LXX**).

B. (:1b) Quick Answer

1. Powerful Denial

“May it never be!”

Michael Bird: Paul responds with an **emphatic denial**, “*By no means!*” (*mē genoito*) to underscore its impossibility (see **3:4, 5-6; 9:14; 11:11**).

2. Proof from Paul’s Personal Testimony

“For I too am an Israelite, a descendant of Abraham, of the tribe of Benjamin.”

Thomas Schreiner: Paul’s intention is not to distinguish among the various tribes of Israel, for that would suggest that it is not sufficient to be an Israelite to be chosen, and that the tribe from which one hails also plays a role in whether one is selected. Instead, the designations “*offspring of Abraham*” and “*tribe of Benjamin*” following “*Israelite*” are merely intended to emphasize that Paul was truly descended from **ethnic Israel** (so **Cranfield** 1979: 545). . .

The emphasis here, however, is not on Paul’s calling but on his **conversion**; the latter demonstrates that God has not forsaken Israel. Paul’s call as a missionary to the gentiles was unique and not a pattern for his kindred, whereas his conversion was a sign that **God had not abandoned Israel.**

R. Kent Hughes: Paul’s case is encouraging. He had been the foremost calculating, implacable, bloodthirsty enemy of the Church. He was so odious to Christians that after Saul’s conversion only Barnabas, a peacemaker par excellence, could affect his acceptance. God had sovereignly hunted him down, smote him on the Damascus Road, and brought him kicking and struggling into the Kingdom. Paul, a hardened, religious man with blood on his hands, came to Christ, so

there is hope for anyone. By the authority of the Word of God we can say that no one is beyond the grace of God. People like Paul are living demonstrations that God is not through with the Jews. What a beautiful gospel to preach!

C. (:2-6) Corroboration from God's Gracious Choice Demonstrated in History

1. (:2a) Thesis: Rejection Unthinkable in Light of God's Election of Israel

"God has not rejected His people whom He foreknew."

Thomas Schreiner: Here, the preservation of the remnant functions more explicitly in an **anticipatory** way: the preservation of the remnant signifies that God isn't finished with his people and thus will fulfill his saving purposes and save Israel in the end (cf. **Hafemann** 1988: 49–50; **Hvalvik** 1990: 90; **Keck** 2005: 265). . .

As in **8:29**, the word προγινώσκειν (*proginōskein*, to *foreknow*) doesn't merely connote foreknowledge but also implies **foreordination**, with the emphasis being on **God's covenant love for his people** (cf. **Amos 3:2**; **1 Cor. 8:3**; **Gal. 4:9**; **2 Tim. 2:19**). Such an understanding of προγινώσκειν (*foreknow*) is confirmed by the immediate context, for "*foreknew*" (προέγνω) clearly functions as the antonym of "*has forsaken*" (ἀπόσατο). The latter verb means "*rejected*," and thus the former means "*selected*."

Michael Bird: The irrevocable nature of Israel's election is based on the immutability of God's knowledge; God cannot unknow the people whom he knows are his (see **Rom 8:29**).

James Dunn: Paul's confidence is twofold: that Israel is not acting in any way unforeseen by God; and that consequently God remains faithful to Israel notwithstanding Israel's failure. Just as the choice of Jacob and rejection of Esau was without regard to their future conduct (**9:10–13**), so Israel's status as God's people remains unaffected by Israel's latest and most serious failure.

S. Lewis Johnson: But someone might say when Paul says, "*I am an Israelite of the tribe of Benjamin and of the seed of Abraham*," one swallow does not make a summer. And the apostle will have a further answer for that. But I want you to notice that expression, "*whom he foreknew*." We've been saying all along that in the Bible when we read of foreknowledge, we really have a word of divine election that we are not to think of this in the way that it is popularly thought of, as if God looked down through the years and saw who would believe and then chose them. The choice then is not God's, the choice is man's. God would be gaining in knowledge, and he's omniscient eternally. Think of this for a moment, if "*whom he foreknew*" means whom he foreknew would believe there is no problem. No one would ever ask the question, "*Has God cast away his people*." If he has foreknown them, he foreknows that they will believe. That's no problem. The problem arises when we think of divine election. He has elected a people, but these people are today in apostasy. Then what about the election, that is a problem. And so the apostle says, "*God has not cast away his people whom he foreknew*." He set his heart upon them in divine love and chose them, is the force of that word. He has not cast away his people "*whom he foreknew*."

2. (:2b-4) Historical Example: Remnant Preserved in Days of Elijah

"Or do you not know what the Scripture says in the passage about Elijah, how he

pleads with God against Israel? 3 'Lord, they have killed Thy prophets, they have torn down Thine altars, and I alone am left, and they are seeking my life.' 4 But what is the divine response to him? 'I have kept for Myself seven thousand men who have not bowed the knee to Baal.'"

Frank Thielman: The addition of “*for myself*” also implies that the seven thousand are God’s people because God took the initiative in making them his people (cf. **11:6**).

Thomas Schreiner: What the story of Elijah does illustrate, however, is that the majority of Israel was apostate (cf. **Käsemann** 1980: 301). Here is the point of similarity between Elijah’s day and Paul’s: most of Israel had refused to acknowledge Jesus as the resurrected Lord, and this refusal is comparable to Israel’s devotion to Baal instead of to Yahweh. From the deplorable state of affairs in Israel, Elijah inferred that he was the only follower of Yahweh left, and Paul fears that one might draw the similar conclusion that God has abandoned Israel since most have not confessed Jesus as Lord. The divine response to Elijah—the word *χρηματισμός* (*chrēmatismos*, *divine response*) indicates an oracular word from God (cf. **2 Macc. 2:4; 1 Clem. 17.5**)—corrects Elijah’s misapprehension and contains a principle that is applicable to the contemporary situation facing the Roman church. . .

The presence of the remnant indicates that the promises will be fulfilled in an even more dramatic way in the future (**J. Wagner** 2002: 237). As **Das** (2007: 246–49) notes, the remnant theme constitutes a weakness in **Merkle**’s claim (2000) that the promise is fulfilled entirely in the salvation of a remnant, since **the presence of a remnant indicates that the promise will be fulfilled in a greater way in the future**, that is, by the future restoration and salvation of Israel. Hence the sparing of Noah signifies the preservation of humanity in the future and isn’t limited to Noah’s family. So too, God brought Joseph into Egypt so that a remnant of Israel would survive (**Gen. 45:7**), pointing to an even greater future for Israel. Hence, “**the remnant is not a replacement for the people as a whole**” (**Das** 2007: 250).

3. (:5-6) Present Day Application: Remnant Now Reflects God’s Grace

- a. (:5) Current Operation of God’s Gracious Choice = Remnant Exists Now
“In the same way then, there has also come to be at the present time a remnant according to God’s gracious choice.”

Frank Thielman: What happened in Elijah’s time provides an analogy to what was happening in Paul’s time. It might seem to Paul’s fictional interlocutor that God’s promise always to bless his people has failed because so few Israelites have embraced the gospel. In fact, however, Paul and other Jewish believers form a remnant of faithful Israelites, and this remnant demonstrates by its existence that God’s gracious choice of Israel has never been in question. . .

This present remnant “*exists*” (*γέγονεν*) because God chose to be gracious to them: the phrase “*by gracious choice*” (*κατ’ ἐκλογὴν χάριτος*) has a causal quality to it. God’s gracious choice of Paul and other believing Jews is the reason why this remnant exists.

John Toews: For the first time since **6:15** Paul reintroduces the word grace; it is clearly a very critical term in his argument, because he uses it four times in two verses. Election, the key term

in Israel's self understanding, and grace, a key term in Paul's theology of salvation and peoplehood, are linked for the first time in Romans. Grace and works are contrasted for the first time in Romans. The elect remnant exists only by an act of God's free and unconditional choice. God did not elect Israel or the remnant because of who they were or what they did. Specifically, grace excludes works, the definition of election that marks Jewish identity. Paul is summarizing his entire argument in these verses—salvation, whether called righteousness or election, is by God's grace (3:24 - 6:15). That is why salvation cannot be restricted to Israel (3:20, 27-28; 9:32).

Douglas Moo: Paul preserves the careful balance he has maintained throughout these chapters as he discusses Israel. God's Word affirms a **continuing role for Israel in salvation history**. But Israel cannot claim this role as a matter of right, for it is due solely to the working of God's grace. This polemical thrust becomes explicit in **verse 6**. "*Grace*" means that "*works*" have no role to play, that God is entirely free to bestow his blessing on whomever he chooses. If those blessings were in fact dependent on our works, God would not be free in his granting of blessing, and "*grace would no longer be grace*."

b. (:6) Cause of Preservation = Grace Not Works

"But if it is by grace, it is no longer on the basis of works, otherwise grace is no longer grace."

Frank Thielman: The gracious nature of God's choice logically implies that nothing these believing Israelites did prompted God to choose them. In Elijah's time, God did not reserve the seven thousand for himself because they refused to "*bow the knee to Baal*" (as the expression "*those who*" [οἱτινες] might otherwise imply), nor in Paul's time did God choose a remnant of Israelites because they did anything that prompted him to be gracious to them.

Thomas Schreiner: One should also observe that Paul's teaching on **election** is indissolubly bound up with his gospel of **justification** (Luz 1968: 82). Those who deny unconditional election introduce, albeit subtly, the notion that human works play a role in obtaining justification and open the door for human boasting (so Müller 1964: 86–87). For Paul, the purity of grace is bound up with the conviction that God elects apart from any work on the part of human beings. Luther (1957) saw this very clearly in his classic work *The Bondage of the Will*. He defended the doctrines of the bondage of the will and unconditional election so vigorously because the denial of either compromised the Pauline gospel that justification is by grace alone through faith alone. The Reformation was propelled by scholars who believed in and preached passionately the doctrine of grace; it would probably not have occurred if Luther, Calvin, and Zwingli were semi-Pelagian. Finally, the election of a remnant of the Jews is no contradiction of **Rom. 9:6–7**, where Paul says that no one's election is guaranteed on the basis of one's pedigree (so Munck 1967: 107–8, 111). What Paul affirms here, however, is that God by his grace freely confers, in accordance with his historic promises, saving grace on a remnant of Jews by virtue of his sovereign will. God sovereignly chooses to redeem those whom he freely chose.

James Dunn: Likewise, precisely because "*of works*" summarizes Israel's misunderstanding of the law within the election of grace, we are also given confirmation that "*works*" for Paul do not

denote “works of merit” which “earn” God’s favor (despite the possible implications of **4:4**). Rather what Paul objects to is “works” understood as a qualification for God’s favor simply because it is they which qualify for membership of the covenant people and which sustain that identity as God’s elect. It is this reduction of God’s election to matters of ethnic and ritual identity which Paul sees as the fatal misunderstanding and abandonment of God’s grace and of the election of grace.

II. (:7-10) GOD’S HARDENING REINFORCES THE STUBBORN REBELLION OF MOST OF ISRAEL

(Israel Stubbornly Resisted God's Ways, So God Deadened Their Senses to Spiritual Truth)

A. (:7) Salvation Depends on God’s Sovereign Choice

1. Human Seeking Is Futile

“What then? That which Israel is seeking for, it has not obtained,”

Frank Thielman: Despite the existence of a remnant of Israelite believers, most of Israel continues to seek for righteousness without attaining it. Attaining righteousness is only possible through faith in Christ, and God has made most of Israel ever more resistant to the gospel as a punishment for their rebellion against him. . .

Within the context of **11:1–10** where Paul is concerned with **physical Israel**, both the larger body and the “*chosen*” subset must refer to physical Israelites. The “*chosen*,” then, are not the multiethnic people of God whether Jewish or gentile but a **small group of Jewish Christians** whom God chose for salvation from his wrath against sin.

2. Sovereign Choice Is the Key

“but those who were chosen obtained it,”

Grant Osborne: This verse provides an excellent summary of **Romans 9-11**. The nation had earnestly sought God’s acceptance by doing works of the law (see **10:2-3**). But God did not accept them. Instead, he accepted the elect—the remnant chosen through his sovereignty and grace. Throughout the Old Testament, God dealt with the people of Israel in two ways: (1) as **individuals**, and (2) as a **corporate community**. At times, God emphasized the responsibility that each person bears for his or her own sins. At other times, God emphasized the fact that the entire nation might be affected by the acts of a few. Paul uses the name Israel to indicate the community of Jews, most of whom rejected Jesus and most of whom were busily but hopelessly pursuing righteousness under the law.

3. Hardening Is the Alternative

“and the rest were hardened;”

Douglas Moo: The Greek verb for “*hardened*” is *poroo*, which in secular Greek often refers to a callous or to the hardening of a bone when it heals after being broken. But in the New Testament, the word always has a metaphorical significance, referring to **spiritual obduracy** (**Mark 6:52; 8:17; John 12:40; 2 Cor. 3:14**; cf. the noun form in **Mark 3:5; Rom. 11:25; Eph. 4:18**). While

the Greek verb in **9:18** is different (*skleryno*), the idea conveyed here is the same. God confirms the **spiritual insensitivity** that people are locked up under by virtue of their sin in Adam.

Michael Bird: Paul is probably tapping into a standard apocalyptic theme that those who do not use the delay in God's judgment to repent and turn back to God will themselves be hardened by God to increase their culpability at the final judgment.

Steven Cole: Chosen or Hardened?

Verse 7 is a brief summary of **Romans 9 & 10**. **Douglas Moo** (*The Epistle to the Romans* [Eerdmans], p. 679, note 45) observes, "It blends the predestinatory focus of **9:6-29**—'elect,' 'hardened'—with the human responsibility perspective of **9:30 - 10:21** — 'sought,' 'did not attain'—to sum up Paul's discussion of Israel to this point in **chaps. 9-11**." In other words, those who are saved are saved because God chose to save them. Those who are lost are lost because they refused to repent and believe the gospel. And then, as Paul has frequently done in **Romans 9-11**, he backs up **verse 7** with Scripture to show that he isn't making this up (**11:8-10**). What Paul says in **verse 7** is in line with all of God's Word. He is saying here:

Either you have been chosen by God to hear, understand, and believe the gospel so that you are saved, or you will be hardened and come under His judgment.

Those are the only two possibilities! While this is not easy truth, it is spiritually nourishing for your soul.

1. If you seek to obtain right standing with God on the basis of your works, you will be hardened and come under God's terrible judgment.

A. ISRAEL SOUGHT RIGHTEOUSNESS BEFORE GOD ON THE BASIS OF THEIR WORKS, NOT ON THE BASIS OF FAITH.

B. IF YOU SEEK RIGHTEOUSNESS BASED ON YOUR WORKS, THEN YOU DON'T NEED A SAVIOR AND CHRIST DIED IN VAIN.

C. IF YOU SEEK RIGHTEOUSNESS BASED ON YOUR WORKS, YOU HAVE NOT JUDGED YOUR PRIDE, WHICH IS THE ROOT SIN.

D. IF YOU SEEK RIGHTEOUSNESS BASED ON YOUR WORKS, GOD WILL HARDEN YOU AGAINST THE TRUTH AND BRING YOU TO ULTIMATE JUDGMENT.

2. If you have been chosen by God, you will hear, understand, and believe the gospel so that you are righteous before God through faith in Christ alone.

A. THE SOURCE OF OUR RIGHT STANDING BEFORE GOD DOES NOT COME FROM US, BUT FROM GOD'S SOVEREIGN CHOICE OF US.

B. THE RESULT OF GOD'S CHOOSING US IS THAT WE HAVE HEARD,

UNDERSTOOD, AND BELIEVED THE GOSPEL, WHICH PROVIDES RIGHT STANDING WITH GOD AS HIS UNDESERVED GIFT.

B. (:8-10) Spiritual Dullness Results from Divine Hardening

“just as it is written,”

1. (:8) Spirit of Stupor

“God gave them a spirit of stupor, Eyes to see not and ears to hear not, Down to this very day.”

Frank Thielman: Paul provides precedent from Scripture for God’s punishment of his people by blocking their ability to understand his revelation of himself. His quotation comes basically from **Deuteronomy 29:4** (29:3 LXX), but with a phrase added from **Isaiah 29:10** LXX (“*a spirit of stupor*” [πνεῦμα{τι} κατανύξεως]) and a few other minor changes. The changes have the effect of emphasizing God’s initiative in causing the insensibility of unbelieving Israel to the gospel.

Everett Harrison: From an observation of the setting of the quotations, it is clear that God did not give his people deaf ears to mock them any more than he gave them blind eyes to taunt them. What was involved was a judicial punishment for failure to use God-given faculties to perceive His manifested power and to glorify Him.

2. (:9-10) Stubborn Rebellion and Spiritual Blindness

“And David says, ‘Let their table become a snare and a trap, And a stumbling block and a retribution to them. 10 Let their eyes be darkened to see not, And bend their backs forever.’”

Frank Thielman: David, in the Psalms, also demonstrates that God sometimes punishes the disobedient among his people by blinding them to the danger of their sin. Israel’s rejection of Jesus was as unjust as the mistreatment of David at the hands of his enemies. . .

What suggested **Psalm 69** to Paul at this point in his argument? Paul’s use of the psalm in **Romans 15:3** to refer to Jesus’s rejection and death (cf. **69:9** [68:10 LXX; 69:10 Heb.]) shows that like other early Christians, he believed the experience David described in the psalm paralleled in significant ways Jesus’s experience of rejection (cf. **John 2:17; 15:25; Acts 1:20**). Here, then, Paul probably thought of the words of the psalm as expressing Jesus’s own pronouncement of judgment on those who had rejected and punished him unjustly.

Thomas Schreiner: The OT texts cited refer to God’s work. He pours out befuddlement on the Jews so that they don’t perceive and comprehend the gospel. He is the one who has reversed their fortunes so that their table of plenty has actually become the scene of their own destruction. He has darkened their eyes and bent their backs in ignominy. We should also recognize that the attribution of hardening to God does not remove responsibility from the Jews. Paul never concluded that since God hardens, therefore the Jews are exculpated from responsibility for their actions. Paul deemed both of these truths to be compatible.

* * * * *

DEVOTIONAL QUESTIONS:

- 1) What are some practical applications to your own life from this record of God's faithful dealings with His chosen nation Israel?
- 2) What would be the point of this chapter if the church has replaced Israel as the recipient of all the OT promises?
- 3) Why is God so concerned that works not be confused with salvation by grace based on God's sovereign choice?
- 4) If God gives people "*eyes to see not and ears to hear not,*" how can He hold them accountable for not seeing or hearing?

* * * * *

QUOTES FOR REFLECTION:

Frank Thielman: Paul did not think that Jewish Christians formed a separate people of God in addition to gentile Christians, but he nevertheless believed that within the one church of Jews and gentiles, **the continuing identity of Jews as Jews** was an important witness to God's faithfulness. . .

Paul believed that God would continue to work through Israel in salvation history even as he showed mercy to all his human creation. Neither Jew nor gentile is subordinate to the other, but Paul acknowledges their separate roles in God's saving plan. . .

The **hardening** Paul describes in **11:7–10**, as we have seen in the comments on that passage, is different than God's hardening of Pharaoh in **9:18**. The hardening of Pharaoh was a final judgment from which there was no recovery, but the hardening of **11:7–10** has not yet arrived at that point. Some of the hardened in **11:7–10** would eventually be among "*all Israel*" that God will save in the end (**11:26**). Those who realize they have become unresponsive, disobedient, and even opposed to God still have time to turn from their rebellion to the God whose arms remain outstretched to them "*all day long*" (**10:21**).

Douglas Moo: Some Jews made the mistake of assuming that God's election of Israel virtually guaranteed spiritual benefits to every member of the nation. Birth into that nation, circumcision (for males), and a reasonable faithfulness in observing the law were all that was needed to ensure one's salvation. Some segments of the church have much the same kind of attitude. People assume that they will go to heaven as long as they can claim such external credits as baptism, confirmation, church attendance, participation in the mass, and acts of service.

Churches that emphasize the sacraments and use a liturgy are more open to this problem than others. I myself grew up in such a church. Despite my baptism as an infant, the faithfulness of my parents in exposing me to the gospel through confirmation, and my regular church attendance, I had no genuine heart commitment to Christ. Faith had not been awakened in me. The fault is, of course, my own. But the church contributed to the problem by failing to bring home to me personally the need to respond to God’s Word and to the sacraments to which I was regularly exposed. I was **presuming on a kind of corporate election**—that members of my church or my family were “in” automatically.

Grant Osborne: WARNING SIGNS OF DEVELOPING HARDNESS

Hardening is like a callus or like the tough bone fibers that bridge a fracture. Spiritual hardening begins with self-sufficiency, security in one’s self, and self-satisfaction. The real danger is that at some point, repeated resistance to God will yield an actual inability to respond, which the Bible describes as a hardened heart. Insensitivity indicates advanced hardening. Here are some of the warning signs:

<i>Warning Sign</i>	<i>Reference</i>
Disobeying—Pharaoh’s willful disobedience led to his hardened heart.	Exodus 4:21
Having wealth and prosperity—Taking God’s blessings for granted can cause us to feel as if they were owed to us.	Deuteronomy 8:6-14
Rebelling and being discontented—Suffering or discomfort can create an attitude that blames God.	Psalms 95:8
Rejecting a deserved rebuke—Rejecting God’s gift makes our neck stiff and our heart hard.	Proverbs 29:1
Refusing to listen—Refusing to listen leads to a loss of spiritual hearing.	Zechariah 7:11-13
Failing to respond—Listening to God with no intention of obeying produces an inability to obey.	Matthew 13:11-15

Steven Cole: (11:1-6) Can God’s Promises Fail?

At first glance, a chapter like **Romans 11** that deals with the subject of whether God still has a purpose for the Jews might seem irrelevant to your life. What does the future of Israel have to do with finding a marriage partner or staying happy with the one you’ve got? What does Israel’s future have to do with the pressures of work and paying bills? How can it help you as you struggle to rear your children in this evil world? What relevance does this topic have as you struggle with personal problems or health problems? Maybe you ought to check out for a few weeks and check back in when we get to the practical stuff in **Romans 12!**

Let me suggest several reasons that this subject should be of interest to you. First, the underlying issue that Paul is dealing with in **Romans 11** is, “Can God’s promises fail?” God chose the nation of Israel as His people apart from all other nations on earth (**Deut. 7:6**). Through the prophet Jeremiah, God assured the sinful nation that was about to go into captivity that His promises to Israel could never fail (**Jer. 31:35-36; 33:19-26**). To dispel the thought that Israel’s sin could lead to their permanent rejection, God added (**Jer. 31:37**), “*Thus says the Lord, ‘If the heavens above can be measured and the foundations of the earth searched out below, then I will also cast off all the offspring of Israel for all that they have done,’ declares the Lord.*”

In other words, if God rejects Israel as His people, then His promises can fail. And if His promises to Israel fail, then how can we know that His promises to us in **Romans 8** will not fail? And since those promises include working all of our trials together for good (**8:28**) and His promise that no trial can ever cut us off from His love (**8:35-39**), the question of why God has seemingly rejected Israel becomes very practical! It boils down to, “Can you trust God to do as He promises?”

Second, on a broader scale, if you pay any attention to the news, you’ve no doubt felt at times that the world is out of control and that the bad guys are winning. You see the horrors of terrorism, war, and natural disasters that wipe out thousands. You hear about terrible crimes toward little children. You read about corruption in government both here and abroad. You hear about Christians getting killed by the Muslims. The list goes on and on. Sometimes it can be depressing to the point that you wonder whether God is really in charge of world events. **Romans 11** shows us that **He is in charge** and that His promises and His purpose will not fail.

This chapter also shows us **how we should view the Jewish people**. Some Christians are so pro-Israel that they wrongly shrug off Israel’s persecution of Palestinian believers, who are our brothers and sisters in Christ. On the other hand, sadly there are professing Christians who are anti-Semitic. During the atrocities of the Holocaust, many of Germany’s professing Christians tacitly went along with Hitler’s evil agenda. But **Romans 11** shows that as Christians, we should love Jewish people and seek to bring them to know Jesus as their Messiah and Savior. My understanding of **Romans 11** is that in the future, the Jewish people will turn to Christ in unprecedented numbers. God is not finished with the Jews.

One other practical value of **Romans 11** is that it helps us to look beyond ourselves to **God’s great purpose for history**, which should lead us to worship Him for His glorious ways. Paul ends the chapter with an outburst of praise as he is caught up with the truths that he writes about here. Sometimes we get so self-focused that we forget that our eyes should be on God and His glory. His plan includes us, but it’s not ultimately about us. It’s about His glory being displayed over the whole earth (**Hab. 2:14; Isa. 11:9**). Our lives take on eternal significance as we devote ourselves to this eternal purpose of God. . .

That God’s promises might fail is unthinkable, because they rest on His sovereign, gracious choice, not on anything in fallen humanity.

God has not rejected His chosen people, but has preserved a remnant according to His gracious

choice. Since the choice of the remnant and its preservation depend on God's grace and not on human works or choice, God's promises cannot fail.

David Thompson: THE PRESENT CONDITION OF ISRAEL IS PERFECTLY CONSISTENT WITH THE SOVEREIGN PLAN AND PROGRAM OF GOD.

SOVEREIGN FACT #1 – God has not abandoned Israel. 11:1-6

This central point comes from **11:1a** - Has God "*rejected*" His people? Has God abandoned Israel because of her obstinate disobedience and rebellion? The answer, "May it never be!" There are those who will tell you that the church has replaced Israel. This is absolute heresy. God has not replaced Israel, nor has He abandoned Israel, nor has He rejected Israel. Truth is, what has been happening to Israel for the past 2000 years is perfectly consistent with His sovereign plan and will. Paul offers four main proofs of this reality:

Proof #1 - The proof of direct statement. **11:1a**

Proof #2 - The proof of Paul's conversion. **11:1b**

Proof #3 - The proof of God's sovereignty. **11:2a**

Proof #4 - The proof of Elijah's experience. **11:2b-6**

SOVEREIGN FACT #2 – God has blinded Israel. 11:7-12

Point #1 - The blindness is partial. **11:7**

Point #2 - The blindness is God-ordained. **11:8**

Point #3 - The blindness is for rebellion. **11:9-10**

Point #4 - The blindness was for the Gentiles. **11:11-12**

(Connection #1) - The Gentiles have an opportunity for salvation. **11:11a**

(Connection #2) - The Gentiles will provoke Israel to jealousy. **11:11b**

Leedy Greek NT Diagrams:

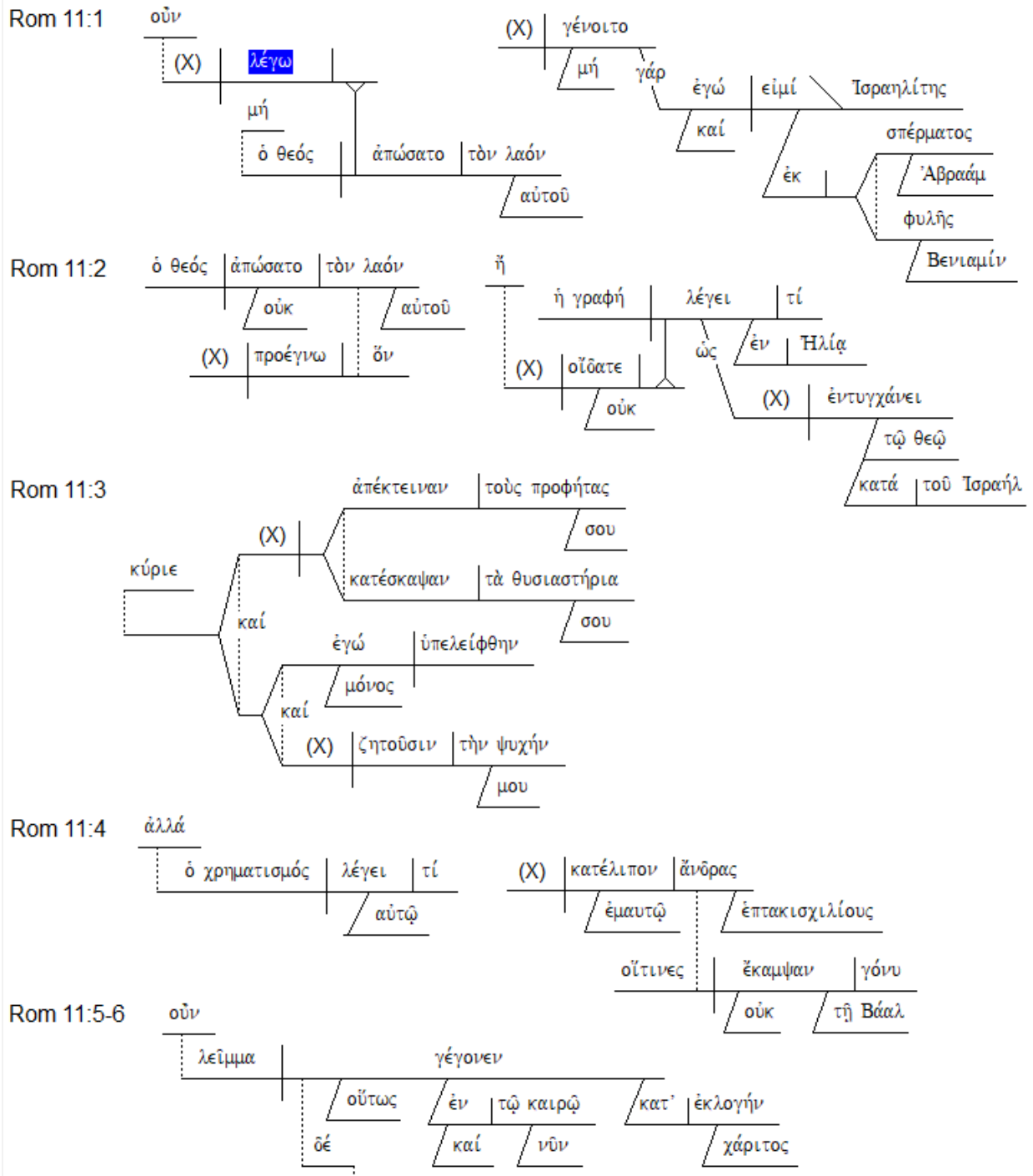

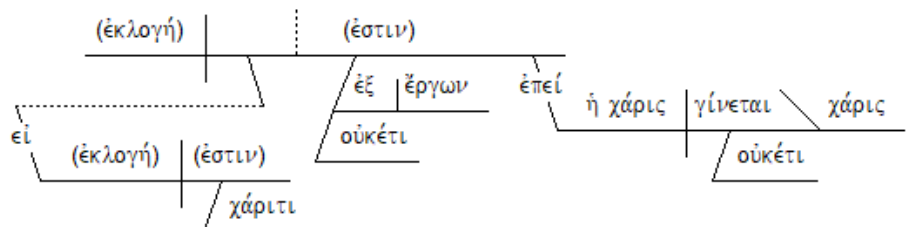

Rom 11:7-8

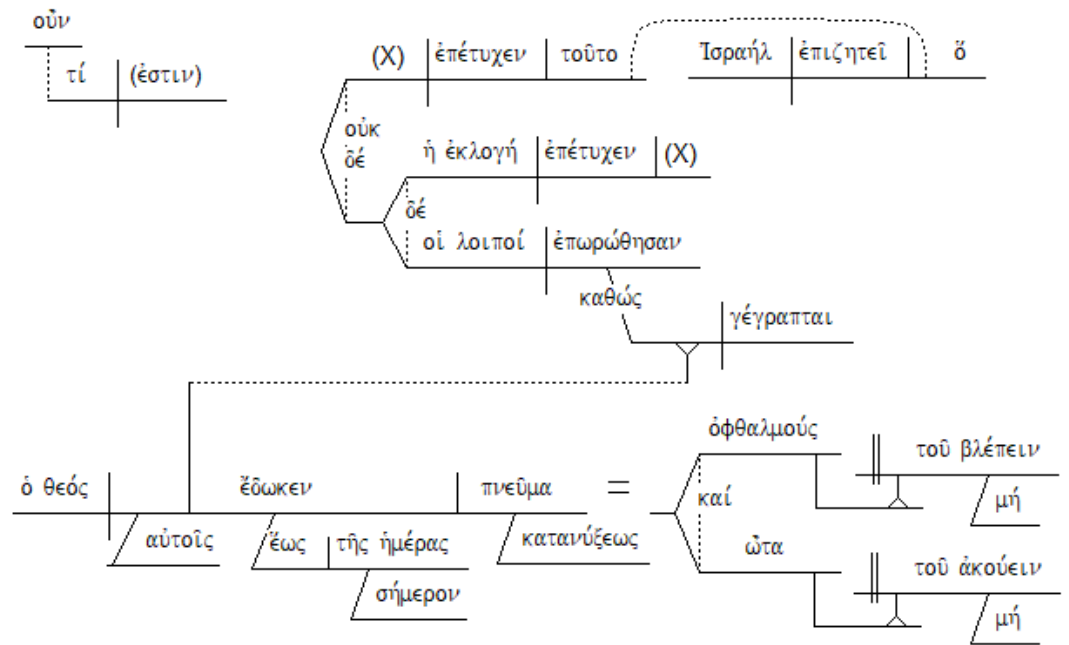

Rom 11:9-10

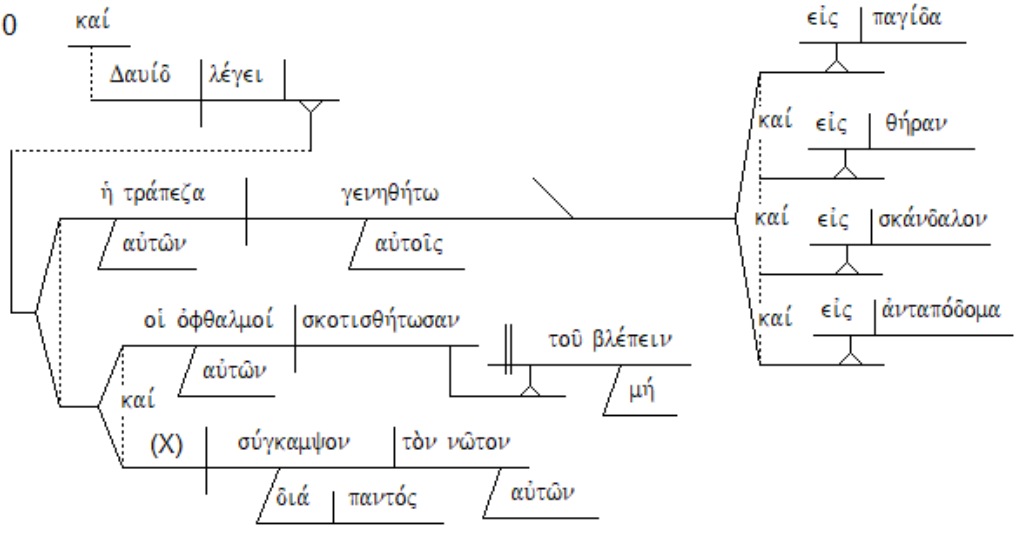

Frank Thielman:

- 1a Rhetorical Question **I say, then, God did not cast off his people did he?**
- b Exclamation **Certainly not!**
- c Basis For **even I am an Israelite,**
- d Description from the offspring of Abraham,
- e Identification from the tribe of Benjamin.
- 2a Restatement (of 1a–b) **God did not cast off his people** whom he foreknew.
- b Rhetorical Question Or **do you not know what the Scripture says** in the section on Elijah?
- 2c–3 Explanation (of 2b) How he appeals to God against Israel,
- “Lord, they have killed your prophets and
torn down your altars, and
- only I am left, and
they are seeking my life.” (1 Kgs 19:10, 14)
- 4a Rhetorical Question But **what does the divine reply say** to him?
- b Explanation (of 2b) “I have left for myself seven thousand men,
those who did not bow the knee to Baal.” (1 Kgs 19:18)

- 5 Inference (from 4b) So, then also, **a remnant exists** in the present time,
by gracious choice
- 6a Condition (of 6b) and
if by grace,
b Inference (from 5) no longer from works,
c Basis (of 6b) since grace would no longer be grace.
- 7a Rhetorical Question **What then?**
- b Assertion **That which Israel seeks,
this it has not attained;**
- c Contrast/
Comparison but **the chosen have attained it,**
- d Explanation (of 7b) and **the rest were hardened.**
- 8 Verification (of 7b) Just as **it is written,**
“God gave them a spirit of stupor, (cf. Isa 29:4)
eyes that do not see and
ears that do not hear until this very day.” (Deut 29:4)
- 9–10 Verification (of 7b) And **David says,**
“Let their table become a bird trap and a net and (cf. Ps 35:8)
a stumbling block and a repayment to them.

Let their eyes be darkened
that they may not see and bend their back continually.” (Ps 69:22–23)

TEXT: ROMANS 11:11-24

TITLE: ISRAEL'S LOSS = GENTILES' GAIN

BIG IDEA:

**ISRAEL'S REJECTION BROUGHT SALVATION TO THE GENTILES
AND WILL ULTIMATELY RESULT IN ISRAEL'S ACCEPTANCE**

INTRODUCTION:

Frank Thielman: This second part of **11:1–32 (11:11–32)** does not merely assert that hardened Israel will one day be saved but explains why, from God's perspective, so many within Israel opposed the gospel in the first place (**9:30 – 10:21**). This was part of a complex plan of God to enclose "*all people within disobedience in order that he might have mercy upon all people*" (**11:32**). God used "*disobedient*" (ἀπειθοῦντα) Israel (**10:21; 11:30–31**) to shift the focus of the gospel's proclamation to non-Israelite people groups. This shift in focus, however, will eventually benefit Israel. As Israel sees gentiles receiving the blessings meant for them, they will emulate the gentile's faith and receive God's mercy also. In the future, vast numbers of Israelites will be saved, and God will stand vindicated as both impartial in his dealings with all humanity and yet faithful to his promises to Israel. In **11:11–32**, then, Paul completes his answer to the question he raised in **9:6** about the failure of the word of God by placing God's faithfulness to Israel on a firm footing. Anyone who might doubt the credibility of Paul's claim that nothing in all creation can separate the people of God from the love of God (**8:39**) should be confident that when history is finished, **God will be found faithful to Israel. . .**

Main Idea: The rejection of the gospel among many Israelites does not mean that God's promise to bless all Israel has failed. The present situation in which Israelite believers are a remnant within Israel and gentile Christians are growing in number will one day change. Once the number of gentiles within the people of God has reached its climax, many Israelite unbelievers will see the blessings that have come to the gentiles and seek to emulate their faith in the gospel. In the end, vast numbers of both gentiles and Israelites will populate the people of God in an amazing display of God's power and wisdom.

Thomas Schreiner: The lapse of Israel is part of God's all-encompassing purpose, for by means of their trespass, salvation has come to the gentiles. . . God planned that the Jews would reject the gospel in large numbers, and in response to their rejection the message was proclaimed to gentiles (cf. **Acts 13:45–48; 18:6; 28:24–28**). **Munck** (1967: 123) observes that **the order is a surprise**, since most Jews believed that they would inherit the blessings of the kingdom first and then some gentiles would also be included. Paul foreshadows **Rom. 11:30–32**, and the **reversal of order** is designed to emphasize that the salvation of both Jews and gentiles is the result of **God's mercy**. Israel will appreciate and praise the mercy of God with a depth that would have been impossible if they had preceded the gentiles, since the latter scenario is what they expected. The inclusion of the gentiles before the Jews reminds all that God works in unexpected ways and that no one deserves his saving grace.

Everett Harrison: Having dealt with the remnant, Paul returns to a consideration of Israel as a whole, insisting that her rejection is not final and that during the period when the nation continues to resist the divine plan centered in the Messiah, God is active in bringing salvation to the Gentiles. The figure of the olive tree emphasizes that Gentile salvation is dependent on Israel's covenant relationship to God. Gentiles have to be grafted into the olive tree. The purpose of gentile influx into the church is not merely to magnify the grace of God toward outsiders, but to evoke envy on the part of Israel as a factor in leading to her ultimate return to God as a people. This in turn prepares the way for the climax in **11:25-27**.

I. (:11-16) ISRAEL'S LOSS LED TO GAIN FOR THE GENTILES AND HER END TIME ACCEPTANCE WILL MEAN EVEN GREATER GAIN

A. (:11a) Basic Question: Is Israel's Rejection Permanent?

"I say then, they did not stumble so as to fall, did they?"

Frank Thielman: Israel, then, has stumbled on a stone in its path that has knocked it off balance, but not so badly that they "*fall*" (πέσωσιν).

B. (:11b) Benefit of Israel's Temporary Rejection

1. Emphatic Rebuttal of Unspeakable Question

"May it never be!"

John MacArthur: They are a disobedient people, a contrary people, a blind people, a deaf people. Their own table becomes for them a snare and a trap, that is the things religiously that they think they're feasting on are going to consume them in reality. And yet with all that judgment talk in **verses 8 to 10**, he comes right back in **verse 11** and says, "*Have they stumbled that they should finally and ultimately fall?*" And the answer is no. It's no.

Is it a permanent falling? It is not a permanent falling. Did the mass of Jews stumble? That verb is interesting, *ptai*, it's an interesting verb. It just means "*a stumbling*." Did they stumble in order that they might fall? That verb means fall in a situation where you could never get back up again. It's one thing to stumble, it's something else to hit with such a crash that you're totally debilitated and can never get up again. Did they fall in order that they would never be able to come back? Is their stumbling complete and irreversible? Is it a permanent falling from which no recovery is ever possible? Is national Israel dead? Are they never to receive the promises? The answer is God forbid. God forbid.

2. End Time Objective Revealed

a. Inclusion of Gentiles in God's Salvation Plan Now

"But by their transgression salvation has come to the Gentiles,"

b. Incitement of Jews to Jealousy to Spur Them to End Time Salvation

"to make them jealous."

James Dunn: God has not abandoned his people even in the act of hardening them. He has not torn up his covenant with Israel and started again. Even his punitive action against the bulk of

Israel has Israel's salvation in view as well. Herein Paul's earlier conviction, that Israel's unfaithfulness has not nullified God's faithfulness (3:3–4), begins to achieve coherent expression. Paul the Jew at last begins to show how even his own people's unbelief and disobedience provides a double source of comfort for his anguish expressed earlier (9:1–3; 10:1); it is precisely that unbelief and disobedience which led to the gospel being offered to the Gentiles, which in turn will spur his fellow Jews to faith. So too what was implicit in 9:14–24 becomes at last clear: that God's outreach in wrath is bound up within his **purpose of mercy**. In the mysterious workings of divine providence God uses human reactions one to another, even when motivated by protective self-interest, to further his own larger outreach of grace.

John MacArthur: So the Lord has humbled His people Israel for a positive reason, by allowing their stumbling, not that they should forever be destroyed, but that Gentiles should be redeemed who become the testimony to the Jews and whose faith the Jews desire to emulate. So by blinding Jewish eyes and hardening Jewish hearts, and deafening their ears, God opens the fount of salvation to all of us. And we can say this, dear friends, we shouldn't be proud either, we shouldn't be proud either, because it is by God's grace and by God's sovereign setting aside of His chosen people Israel that we have even been brought the gospel. And the lives of us who are redeemed Gentiles should be powerful, joyful, peaceful, hopeful testimonies of what God can do in a life that should be attractive to Jews who have rejected the Savior. And how we live before the Jews and how we act and how we speak and how we manifest the love of Jesus Christ in the transformed life is, I believe, the single greatest testimony we have to Israel. I'm so thrilled when I see Jews come to Christ because they're attracted by the reality of Christ in the life of His church.

C. (:12-16) **Bright Future for Both Jews and Gentiles**

1. (:12) Prosperity Abounds

*“Now if their transgression be riches for the world
and their failure be riches for the Gentiles,
how much more will their fulfillment be!”*

John MacArthur: Negatively, if their sin accomplished that, can you imagine what their righteousness will accomplish? That's his argument. If they accomplish so much in a negative way, it's hard to even conceive of what will happen in a positive way. If a negative can produce such results, what can a positive produce?

Frank Thielman: In Paul's thinking, God was enormously rich (11:33), particularly in kindness (2:4; cf. Eph 1:7; 2:7) and glory (Rom 9:23; cf. Eph 1:18; 3:16; Phil 4:9; Col 1:27), and believers shared in these riches (1 Cor 1:5; 2 Cor 6:10; 8:9; 9:11; Eph 3:16; Phil 4:19). When Paul preached the gospel to the Jews first in the various cities to which he traveled and they rejected it, he then focused on the gentiles, many of whom believed the gospel and received a share in God's wealth (Acts 13:44–49; 18:5–8; 19:8–10; 28:17–28). . .

Far from adopting an arrogant attitude toward Jews (cf. 11:18), gentile Christians in Rome ought, like Paul, to appreciate the important role that physical Israel has played and will play in God's saving purposes for all peoples of the world.

Everett Harrison: The word “*fullness*” refers to the conversion, meaning the full complement in contrast to the remnant. It will mark an end to the state of hardening that now characterizes the nation.

John Murray: “*Fulness*” often means the plenitude or totality. It can be the full complement. In this instance it is not merely contrasted with “*loss*” but also with “*trespass*”. Whatever might be the precise term by which to express the import here, it is obvious that the condition or state denoted is one that stands in sharp contrast with the unbelief, the trespass, and the loss characterizing Israel when the apostle wrote. It points, therefore, to a condition marked by antithesis in these respects. This means that Israel is contemplated by the faith of Christ, by the attainment of righteousness, and by restoration to the blessing of God’s kingdom as conspicuously as Israel then was marked by unbelief, trespass, and loss. No word could serve to convey the thought of the thoroughness and completeness of this contrast better than the term “*fulness*.” For if “*fulness*” conveys any idea it is that of completeness. Hence nothing less than a restoration of Israel as a people to faith, privilege, and blessing can satisfy the terms of this passage. The argument of the apostle is not, however, the restoration of Israel; it is the blessing accruing to the Gentiles from Israel’s “*fulness*”. The “*fulness*” of Israel, with the implications stated above, is presupposed and from it is drawn the conclusion that the fulness of Israel will involve for the Gentiles a much greater enjoyment of gospel blessing than that occasioned by Israel’s unbelief. Thus there awaits the Gentiles, in their distinctive identity as such, gospel blessing far surpassing anything experienced during the period of Israel’s apostasy, and this unprecedented enrichment will be occasioned by the conversion of Israel on a scale commensurate with that of their earlier disobedience. We are not informed at this point what this unprecedented blessing will be. But in view of the thought governing the context, namely, the conversion of the Gentiles and then that of Israel, we should expect that the enlarged blessing would be the expansion of the success attending the gospel and of the kingdom of God.

Grant Osborne: Israel’s acceptance does not mean that the riches given to the Gentiles will be taken away; rather, when the Jews are saved, the Gentiles will enjoy even **greater blessings** along with them.

James Dunn: The meaning is plain: Israel’s rejection brought benefit to the rest of humankind; Israel’s acceptance will bring still more benefit to humankind. And the point is clear too: Israel’s future conversion does not mean that the benefits which have accrued to the Gentiles will be withdrawn; on the contrary, Gentiles will enjoy still greater benefits along with Israel. Israel’s spiritual prosperity and the rest of world’s are not antithetical; “*the wealth of nations*” means wealth for all.

2. (:13-14) Paul’s Role as Apostle to the Gentiles

“But I am speaking to you who are Gentiles. Inasmuch then as I am an apostle of Gentiles, I magnify my ministry, 14 if somehow I might move to jealousy my fellow countrymen and save some of them.”

Frank Thielman: Paul inserts into this brief and allusive statement of his thesis a reference to his own role in these significant events. He is an apostle to the gentiles, and so God is using him indirectly and partially to accomplish these salutary results for hardened Israel (**11:13–14**).

Grant Osborne: Paul is emphasizing God's sending him to the Gentiles in order to somehow arouse his people to envy and save some of them. Paul's reference to envy means that he hopes to cause the Jews to recognize that God greatly blessed the Gentiles when they believed in the Jews' own Messiah. The Jews might then realize that those blessings are still promised to them as part of God's covenant with them, but they can only be obtained by faith in Jesus Christ. Again Paul is revealing his great desire to see his people be saved (see **9:1-3; 10:1**).

3. (:15-16) Permanent Future of God's People (Jews and Gentiles) Will Be Glorious

a. (:15) Two Illustrations of Israel's Positive Impact on the World

1) Illustration Based on Israel's Historic Rejection

"For if their rejection be the reconciliation of the world,"

2) Illustration Based on Israel's Future Acceptance

"what will their acceptance be but life from the dead?"

John MacArthur: *Life from the dead.* And he's not talking about personal resurrection. He's not talking about the resurrection from the dead which would be the Pauline term. Life from the dead refers to the rebirth, if you will, of the **nation** and the **rebirth of the world** in the glory of the kingdom. I think that's the proper way to interpret it. When Israel is received, he's not speaking about individual resurrection from the dead, but *life from the dead*, a unique phrase used here, which I believe refers to **national resurrection of the nation Israel to the place of blessing and world resurrection, as it were, in the recreated new heaven and earth of the millennial kingdom, right?** That's the *life from the dead*. The nation and the world, when the kingdom comes, will be delivered from its spiritually dead state and there will be new life. It is not, as I said, the phrase, "*resurrection from the dead*," which is Paul's concept that he refers to when he refers to individual resurrection, but the resurrection of the nation into kingdom glory. It's that which **Romans 8** describes as the glorious liberation of the children of God, the manifestation of the sons of God, when we enter into the glorious kingdom and are made manifest to the world as the true children of the living God.

A. Berkeley Mickelsen: This undoubtedly refers to the climax of reconciliation in the return of Christ, the resurrection of the dead, the deliverance of creation from slavery to deterioration or decay (**8:21**), and the glorious reign of Christ.

Grant Osborne: Though we may not grasp all the nuances of Paul's extensive argument, his purpose is unmistakable. He wants to give Gentiles every reason possible to welcome their Jewish brothers and sisters in the faith with open arms. At the same time, he wants to help his Jewish brethren reciprocate that welcome. Neither group is to claim supremacy in the church. The message is: God has made room in his family for both of you, so you must get along together.

b. (:16) Two Illustrations of Israel's Permanent Sanctification

1) Illustration from First-Fruits

"And if the first piece of dough be holy, the lump is also;"

2) Illustration from Root and Branches

“and if the root be holy, the branches are too.”

Thomas Schreiner: Paul is more likely using two illustrations to make the same point: God’s choice of the patriarchs indicates that the people of Israel as a whole are consecrated to him (cf. **Byrne** 1996: 340). The illustration from first-fruits was used because the notion of holiness relates more appropriately in this instance than it does in the case of the root and branches. . .

Thus both illustrations make the same point: the election of the patriarchs sanctifies Israel as a whole. Ethnic Israel is not cast off but still remains the elect people of God because of the promise made to the fathers (**vv. 28–29**). Does this contradict the earlier argument (**9:6–13**) in which **ethnic** and **spiritual Israel** are separated? Paul seems to assert here that Israel is holy because of its relation to the patriarchs. The reason for the difficulty is that Paul’s answer as to whether Israel is part of the people of God is both yes and no. No individual Israelite can presume on God’s election, since God has always chosen some Israelites and not others. Yet it is also the case that he does not reject the people of Israel corporately, and he has promised to save the great majority of the end-time generation.

Grant Osborne: Each of these illustrations conveys a different idea. In the first, a sample, or tithe, or first-fruits **represents the whole**. In the second, the foundation, source, or root **determines the quality of the particulars** (branches).

A. Berkeley Mickelsen: The first fruits of dough and the root refer to Abraham and the other patriarchs, Isaac and Jacob (see Paul’s stress on “*the fathers*” in **9:5** and **11:28**).

John Witmer: In both illustrations the principle is the same: what is considered first contributes its character to what is related to it. With a tree, the root obviously comes first and contributes the nature of that type of tree to the branches that come later. With the cake presented to the Lord, the flour for the cake is taken from the ground meal, but that cake is formed and baked first and presented as a first-fruit. Since it set apart to the Lord first, it sanctifies the whole harvest. The first-fruits and the root represent the patriarchs of Israel or Abraham personally, and the lump and the branches represent the people of Israel. As a result Israel is set apart (holy) to God, and her “*stumbling*” (rejection of Christ) must therefore be temporary.

Warren Wiersbe: No matter how far Israel may stray from the truth of God, the roots are still good. God is still the “*God of Abraham, and the God of Isaac, and the God of Jacob*” (**Ex. 3:6; Matt. 22:23**). He will keep His promises to these patriarchs. This means that the olive tree will flourish again!

James Dunn: The recipients of the letter would probably feel no compulsion to interpret both metaphors of **v 16** in precisely the same way; as metaphors all they have in common is the **chronological sequence** of the two halves in each case. On the contrary, indeed, it is important to recognize the different reference of the two metaphors, for they are **complementary** rather than **synonymous**. “*The mixture*” and “*the branches*” certainly have the same reference—the people of God in its final composition. But “*the first offering*” and “*the root*” refer precisely to the two different elements which will constitute God’s elect in the end: on the one hand, the Jews

and Gentiles who have already believed, and, on the other, historical Israel. The holiness of the end-time saints is dependent both on their continuity with the original Israel and on the word of faith which constitutes the remnant and the gentile mission. In this way Paul maintains his double loyalty, flesh of Abraham's flesh, faith of Abraham's faith, a Jew who is also apostle to the Gentiles, called to proclaim the gospel of God's Son to Jew first but to Gentile as well.

II. (:17-21) NO ROOM FOR PRIDE OR BOASTING – JUST FEAR OF THE LORD

A. (:17-18) Gentiles Must Not Be Arrogant But Respect Israel's Heritage

1. (:17) Gentiles Share Covenant Blessings with Foundational Israel

*“But if some of the branches were broken off,
and you, being a wild olive, were grafted in among them
and became partaker with them of the rich root of the olive tree,”*

2. (:18) Gentiles Are Supported by the Root of Judaism – Don't Be Arrogant

*“do not be arrogant toward the branches;
but if you are arrogant,
remember that it is not you who supports the root, but the root supports you.”*

Frank Thielman: It might seem natural for Gentile believers in Rome to gloat in triumph over the irony that they had actually attained what Israel's heritage should have led Israel to attain (cf. **Rom 9:30 – 10:4**), or that God had hardened Israel so that the gospel might go to the gentiles (**11:11**). Here Paul forbids any such triumphalism by pointing out the fundamental theological misunderstanding that such an attitude would represent. Gentile believers have only attained the righteousness of God through their attachment to Israel's heritage, and that heritage contains God's unbreakable promises to Israel (**11:28–29**).

B. (:19-21) Gentiles Must Not Be Conceited But Fear God

1. (:19) Danger of Conceit

“You will say then, ‘Branches were broken off so that I might be grafted in.’”

2. (:20a) Determining Factor = Faith Not Merit

“Quite right, they were broken off for their unbelief, but you stand by your faith.”

John MacArthur: So, **verse 20** says, "Be not high-minded." That is, don't get yourself way up here looking down on other people. Don't think high about yourself. Don't have lofty thoughts about your superiority. The only difference between you and an apostate Jew is he didn't believe and you did believe. That's the only difference. You're no more or less worthy in and of yourself of salvation. It's just that they didn't believe and you did. And that by the grace of God, right?

3. (:20b-21) Danger of Rejection – Don't Be Conceited But Fear God

*“Do not be conceited, but fear;
21 for if God did not spare the natural branches, neither will He spare you.”*

Frank Thielman: Compared to the Israelite, it is easy to see that the gentile who belongs to God's people is there only by trust in God's gracious offer of reconciliation through the death of Christ. The gentile who has adopted a haughty attitude toward Israel should fear God's judgment because this attitude betrays a lack of faith. It hints that the gentile believer imagines God is somehow obligated to him or her. If this is not true for the Jew, Paul says here, it is hardly true for the gentile.

Thomas Schreiner: The example of the Jews should inspire not pride but **fear**, for God will not spare gentiles either if they relapse into unbelief (v. 21). Instead of being proud, gentiles should ponder God's kindness and severity (v. 22). He has been severe to the Jews who have fallen away, while his kindness has been bestowed on gentiles. But this **kindness is conditional**. The gentiles will be cut off from the olive tree as well if they depart from God's kindness. . .

By capitulating to pride, gentile believers ironically were falling into the same problem that plagued the Jews. Paul warns the Jews throughout Romans (esp. **chaps. 1–4**) of the danger of vaunting themselves above gentiles because of their elect status. Now he admonishes the gentiles that they are prone to the same deception (rightly **Dunn** 1988b: 662). Thus we have canonical warrant for the claim that the temptation to pride is not uniquely Jewish but is fundamentally human. It also follows that the warnings addressed to the Jews can be applied in principle to believers of today, since **11:17–24** indicates that gentiles (and therefore all people) are liable to the same sin committed by the Jews. This text strengthens the case that there were problems between Jews and gentiles in Rome, and this theory is confirmed by **14:1 – 15:13**, where tensions between Jews and gentiles come to the forefront.

James Dunn: If God's electing purpose for Israel can comprehend within it the rejection of so many Jews, if this is the way election and judgment can be seen actually to work out in practice, how much more easily could a few Gentile branches be lopped off without modifying God's overall purpose one whit, and how much more should the individual Gentile be on his guard against the fatal pride.

III. (:22-24) DON'T FORGET GOD'S KINDNESS, SEVERITY AND ABILITY

A. (:22) God's Kindness and Severity

1. Description of God's Character = Kindness and Severity

"Behold then the kindness and severity of God;"

2. Demonstration of God's Character

a. Severity Demonstrated towards the Jews

"to those who fell, severity,"

b. Kindness Demonstrated to the Gentiles

"but to you, God's kindness,"

c. Conditional Nature of God's Kindness

"if you continue in His kindness;_otherwise you also will be cut off."

John Witmer: This does not suggest that a Christian can lose his salvation; it refers to Gentiles as a whole (suggested by the sing. *you*) turning from the gospel much as Israel as a nation had done.

B. (:23-24) God's Ability – Argument from the Greater to the Lesser

1. (:23) His Ability to Ultimately Graft Israel Back into Covenant Acceptance

“And they also, if they do not continue in their unbelief, will be grafted in; for God is able to graft them in again.”

A. Berkeley Mickelsen: Now Paul stresses God's ability. God is powerful, strong, mighty – able to graft these in again. Since, in the language of the metaphor, the Lord did what was contrary to nature, he can certainly put natural olive branches back into the natural olive tree.

2. (:24) His Ability Already Demonstrated in His Integration of the Gentiles

“For if you were cut off from what is by nature a wild olive tree, and were grafted contrary to nature into a cultivated olive tree, how much more shall these who are the natural branches be grafted into their own olive tree?”

James Dunn: Not surprisingly, given Paul's train of thought, the conclusion to his extended metaphor of the olive tree of Israel is a reversion to the hope of his kinsfolk's restoration to their former place within God's covenant purpose. Not only can the gentile branches be lopped off (if they turn from faith to unfaith), but the old branches can be grafted in again (if they turn from unfaith to faith). For **God is able to do it**. Paul recognizes how far his exposition is straying from the metaphor, but the horticultural impossibility becomes a way of emphasizing the power of God. Here again grace needs only faith as the opening through which it can pour its life-giving energy to revitalize even branches withered by Israel's false assurance. For if God can perform the physiological impossibility of making Gentiles full members of the covenant people, seed of Abraham and heirs of the promise, how much more easily can the natural seed and heirs be reincorporated into what is actually their own people and their own inheritance. Once again, Paul implies clearly, what he has in mind is by no means a wholly new beginning, but rather a concept of the **people of God** whose basis and character has been obscured by Israel's misunderstanding, is being discovered afresh through the gospel not least by the Gentiles, and will shortly be reestablished among the rest of Israel as well.

* * * * *

DEVOTIONAL QUESTIONS:

- 1) Where do we see a spirit of elitism in the church?
- 2) How can we guard against spiritual pride?
- 3) Why should it not be surprising to see that the present day church is primarily composed of Gentiles?
- 4) What should our attitude as Christians be today towards the nation of Israel?

* * * * *

QUOTES FOR REFLECTION:

John Witmer: This passage does not teach that the national promises to Israel have been abrogated and are now being fulfilled by the church. This idea, taught by amillenarians, is foreign to Paul's point, for he said Israel's fall is temporary. While believing Gentiles share in the blessings of the Abrahamic Covenant (**Gen. 12:3b**) as Abraham's spiritual children (**Gal. 3:8-9**), they do not permanently replace Israel as the heirs of God's promises (**Gen. 12:2-3; 15:18-21; 17:19-21; 22:15-18**).

David Thompson: THE GENTILE BELIEVER AND GENTILE CHURCH MUST NEVER FORGET ABOUT THE IMPORTANCE OF THE NATION ISRAEL.

Paul never wanted the Church to forget about the Jewish people, the Jewish program and the Jewish promises. There are six memories that God wants us to have about Israel:

MEMORY #1 – Our salvation is for Israel's benefit. **11:13-14**

MEMORY #2 – Our salvation is proof of Israel's future. **11:15-16**

MEMORY #3 – Our salvation is rooted in Israel's program. **11:17**

I understand this verse to be subordinate to **verse 18**; however, I think it contains a thought worth developing. The real meaning here is that we have no right to boast or be arrogant because our life support system is rooted in a God-ordained system pertaining to Israel. The illustration comes from the world of horticulture. The "*natural branches*" are Israel and the "*wild olive grafted in branches*" represent the church or believing Gentiles. What Paul is saying here is that **God has grafted us into Israel's program**. Israel was not grafted into our program.

MEMORY #4 – Our salvation should boast about Israel not against Israel. **11:18**

We have no right to boast about our salvation at the expense of Israel. Anti-Semitism is antigodly thinking. No believer should ever think or act arrogantly against the Jew. We can thank God that Israel exists because our salvation is rooted in her. Look at the words of Jesus in **John 4:22** who said, "*We worship that which we know, for salvation is from the Jews.*"

MEMORY #5 – Our salvation stems from Israel's unbelief, not our greatness. **11:19-20**

MEMORY #6 – Our blessings can be canceled because of an improper attitude toward Israel. **11:21-24**

Paul says there are two sides to God - kindness and blessings, and severity and judgment. Paul says in **verse 22**, if we continue in His kindness, we get His blessing; if we don't we will be cut off. The idea of being "*cut off*" is not a reference to individual salvation, but to **national**

purposes in the program of God. In other words, God can and will shut the whole Gentile program down when it starts demeaning Israel. In fact, Paul says in **verse 24** that if God grafted us into Israel's program, He would be much quicker to graft in the original branches again.

Steven Cole: Guarding Against Spiritual Pride (:16-24)

Spiritual pride is an insidious enemy that we all continually must guard against and fight. It was one of the main sins of the Pharisees. They thought that they were a notch above their fellow Jews (**John 9:28-34**) and far above the despised Gentile dogs. To confront such pride, Jesus told the parable of the Pharisee and the publican who went up to the temple to pray (**Luke 18:9-14**). The Pharisee thanked God that he wasn't like the publican. But how many times have you read that story and thought, "Thank God that I'm not like that Pharisee!"

In our text, Paul counters this problem with an illustration of an olive tree and its branches. He shows the Gentiles that they are not the root, but rather are branches from a wild olive tree that have been grafted into the cultivated tree, supported by the root. Three times (**11:18, 20, 25**) Paul directly warns Gentile believers against **spiritual pride**. They were no better than the Jews, but were grafted into the tree by God's grace alone. And if the Gentiles do not curb their pride, they could be broken off as the unbelieving Jews were. He also encourages evangelism toward unbelieving Jews by showing that in God's sovereign plan, the branches that were broken off because of their unbelief will be grafted back in when they believe (**11:23**). In fact, God is moving salvation history toward that end (**11:25-26**). Applied to us, Paul's message is:

Guard against spiritual pride by remembering that salvation is by grace alone and by maintaining faith and fear before the God of kindness and severity.

Conclusion

Martyn Lloyd-Jones wisely observed (*Romans: To God's Glory* [Banner of Truth], p. 125), "The best corrective against pride ... is to know God, His character and the truth about Him." And the main place to behold the kindness and severity of God is **at the cross**. There the severity of His righteous judgment did not spare His own Son, but delivered Him up for us all (**Rom. 8:32**). There the kindness of His tender love forgave all our sins and adopted us as His beloved children the instant we trusted in Christ. Guard yourself against any form of spiritual pride by remembering that salvation is by grace alone and by maintaining faith in Christ and fear before the kindness and severity of God.

John MacArthur: Has God Cancelled His Promises to Israel?

And I really believe there is no better proof of the faithfulness of God than the redemptive history of Israel. No single thing more demonstrates God's faithfulness to His promise than His unfailing love for the nation Israel, a nation which in fact did everything to negate those promises, everything to violate that love. And still God is true to His promise and true to His love, unchangingly and unwaveringly. In spite of their sin, in spite of their rejection, in spite of their unbelief, there is still a place for the nation Israel in the plan of God. That is the reality of Romans chapters **9, 10** and **11**. That is the message that Paul is communicating in this great, great section of the epistle. And he brings it into this epistle, which is an epistle on salvation, to demonstrate how faithful God is to His promise. If He promises you

salvation, believe me, He will grant it. If He promises you redemption, He will give it. And Israel is a classic illustration.

Purposes of the temporary setting aside of Israel:

- 1) Gentile blessing (:11a)
- 2) Jewish jealousy (:11b)
- 3) World blessing (:12)

Paul then says in **verse 13, 14 and 15** that this is the **direction of his ministry**. He says, "*I speak to you Gentiles, yes, because I am the apostle of the Gentiles and I magnify that office.*" I don't diminish that office, I don't lessen that office, I am the Apostle to the Gentiles and I am honored to be such, but my real purpose is in seeing Gentiles come to Christ in order to provoke to jealousy them who are my flesh that some of them might be saved.

Warning against Gentile Pride

Now what is Paul intending by these analogies (:16)? Just this, and it's just a beautiful thought. If one portion of the Jewish people are consecrated to the Lord, then all the rest must be also. You got it? And who were the first fruits? Abraham, Isaac, Jacob, Joseph, the fathers, the patriarchs. And I believe he has, of course, here mainly in mind Abraham. And if God set apart the first fruits, then He was setting apart the whole lump. And if God set apart the root, who was Abraham, then He's setting apart the branches. In other words, this is Paul's way of saying, "You Jews know very well that a part of a thing consecrated intends to say that the whole is consecrated. And if God sets apart the root and God sets apart the first fruit in the case of Abraham and the fathers, it is to say that He has consecrated to Himself the whole." It's a beautiful thought. . .

(:17) They would cut off the unproductive old branches and in the process of grafting, even as people do today, graft in a scion or a shoot from a wild olive tree that would be very productive. And the strength of those old roots and mingled with the strength of that new life at the branch would create a new kind of productivity. And the analogy is lucid. The trunk, if you were, is the trunk of blessing, the trunk of special relationship to the living God. And the branches are Israel. You might compare **Jeremiah 11** verses **16 and 17** or **Hosea 14:6**, and Israel was the original set of branches on the trunk of blessing, the trunk of covenant blessing. But Israel in unbelief became unproductive and so God came along and cut the branches off, right? And grafted in... And who is the wild olive grafted in? Gentiles, very clearly, Gentiles. . .

So instead of being **boastful** and **proud** that we've been grafted in as over against apostate Jews who have been cut off, we ought to be **afraid** because Israel's unique privileges provided no protection for them against their unbelief, then certainly our lack of such privilege will provide no protection for us either. You see, we are a *no people*. We are *strangers to the covenants of God*, that's right, as Gentiles. We are *aliens from the commonwealth of Israel*. We have *no hope, are without God in the world, we're far off*. That's **Ephesians 2:11 to 13**. We are the *no people*. And we have become a people by grace, but if God acted the way He did against His own natural branches, then believe me, if we as a church, and he's speaking in broad terms now, enter into unbelief, He'll cut the church off just as fast as He cut Israel off, just as fast.

So there's **no place for boasting**, people, as if we're better than Israel. The same fate awaits the apostate church that awaited apostate Israel. Gentiles are going to get the same thing Jews got. And the only people who maintain their place in the trunk of blessing are the faithful Jew and Gentile, the physical and the spiritual seed of Abraham.

So the blindness of Israel is only temporary and it has a **definite purpose** and a **definite premonition** or warning. Now finally, and just briefly because we'll cover this more the next time, it has a **definite promise**. And I can't leave without this promise, oh what a marvelous promise. **Verse 23**, "*And they also (that is, Israel) if they abide not still in unbelief.*" That's always the issue. If they will believe, they will be what? Grafted in. You see it? If they believe, they'll be grafted in. "*For God is (Here it is.) able to graft them in again.*" May I say to you that it is possible. That's what that verse is saying. If they will abide not in unbelief, if they will come to faith. You say, "Will they?" Zechariah says they will. "*They'll look on Him whom they've pierced and mourn for Him as an only son and a fountain of salvation will be open to Israel.*" The day is coming, I believe it's in the tribulation time, when they will believe. And in the tribulation is when the apostate church will be cut off and Israel will be grafted back in and they will again become the people of blessing.

The destiny of Israel can be reversed. **Verse 23** says, it is possible, God is able to do it. **Verse 24** says, it's probable, for if you were cut out of the olive tree which is wild by nature and grafted contrary to nature into a good olive tree, how much more shall these who are the natural branches be grafted into their own olive tree. It's not only possible, it's probable. If we wild olive branches got grafted in, how much more is it probable that the original branches should be grafted in? So it's not only possible, it's probable.

Leedy Greek NT Diagrams:

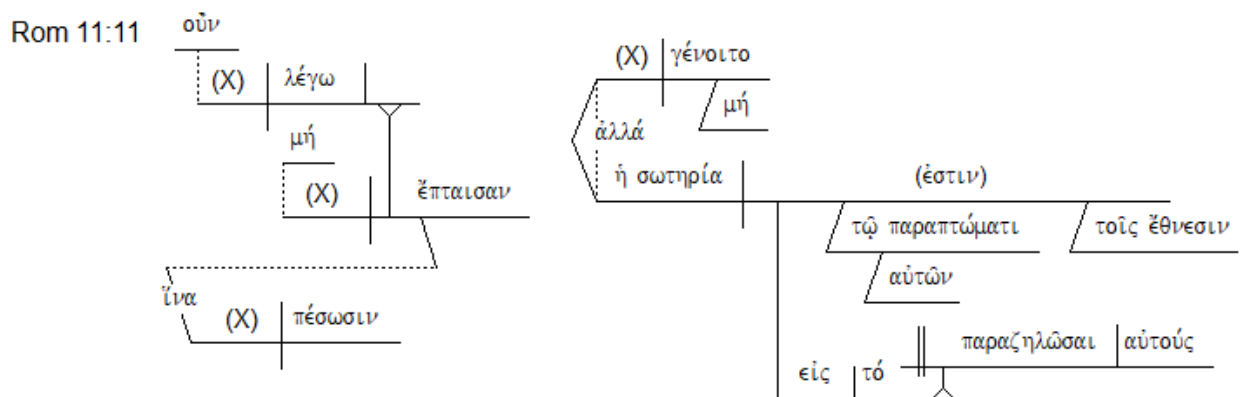

Rom 11:12

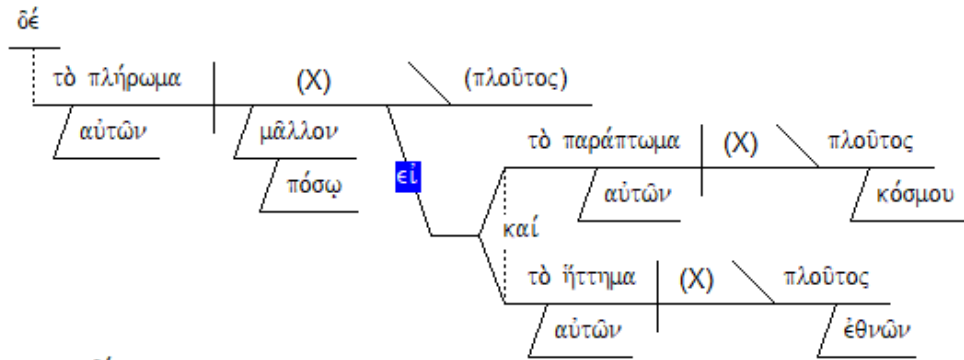

Rom 11:13-14

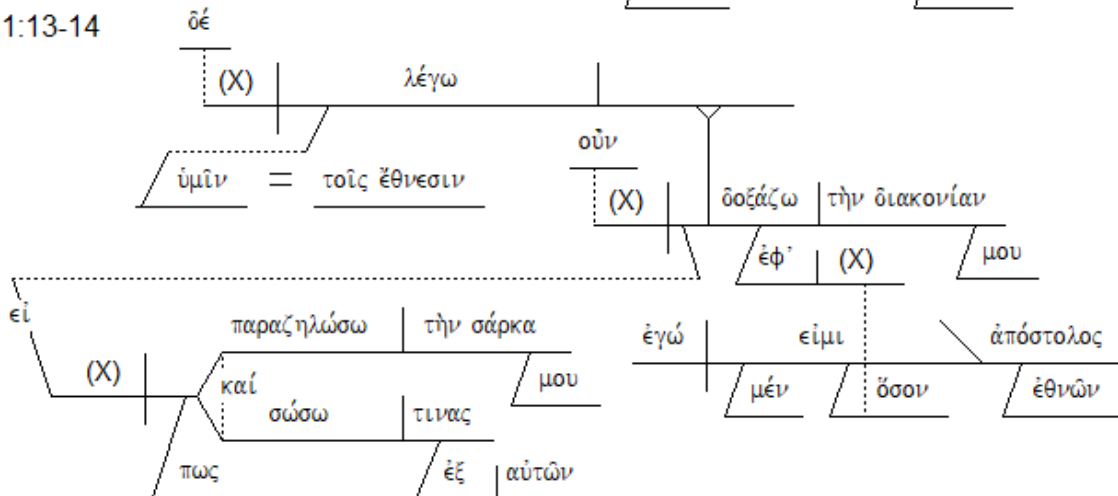

Rom 11:15

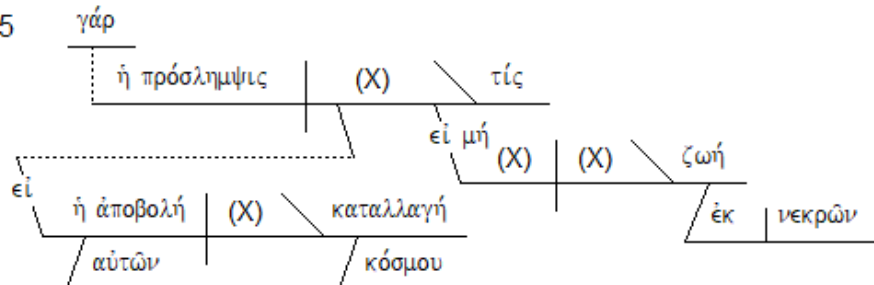

Rom 11:16

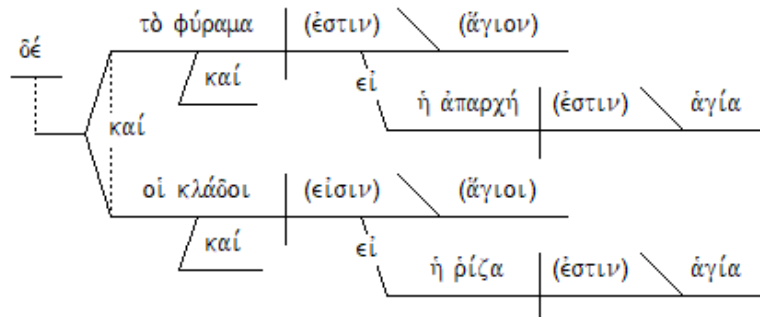

Rom 11:17-18

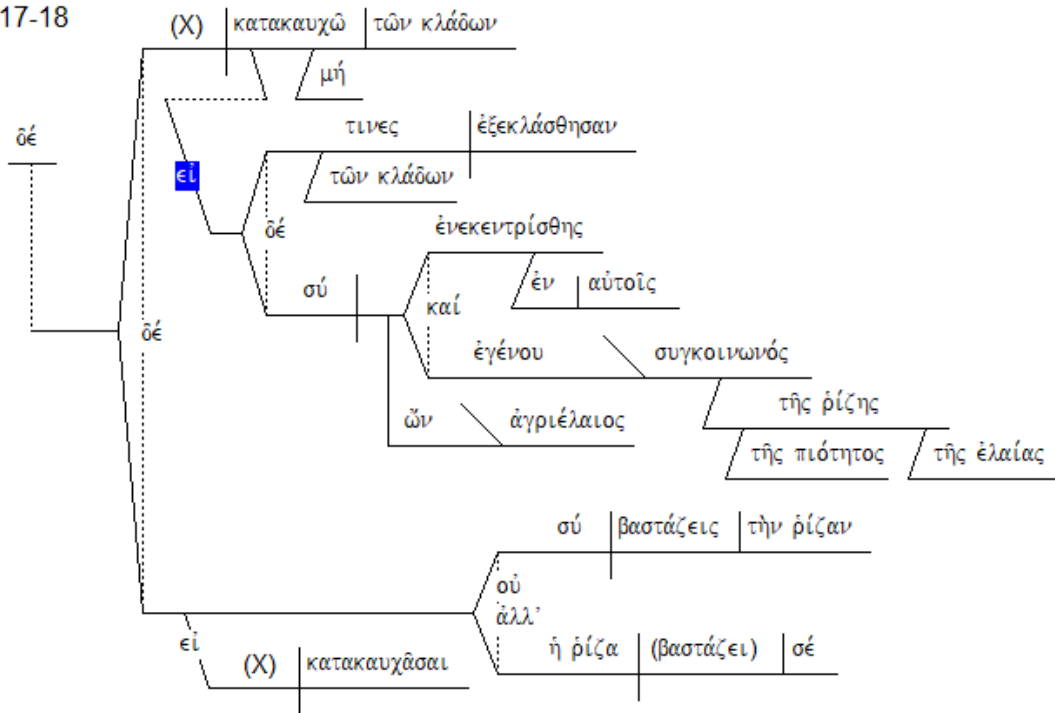

Rom 11:19

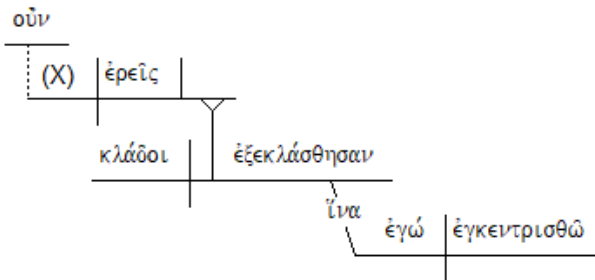

Rom 11:20-21

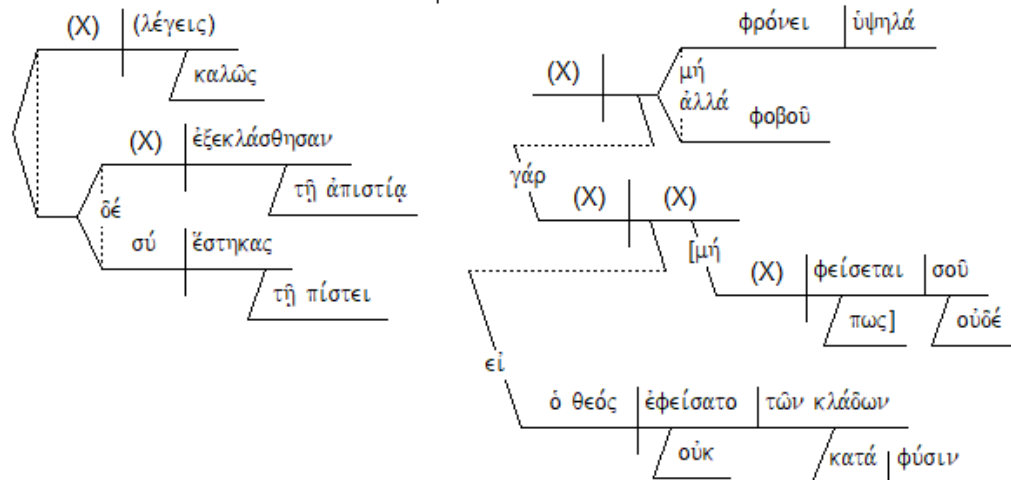

Rom 11:22

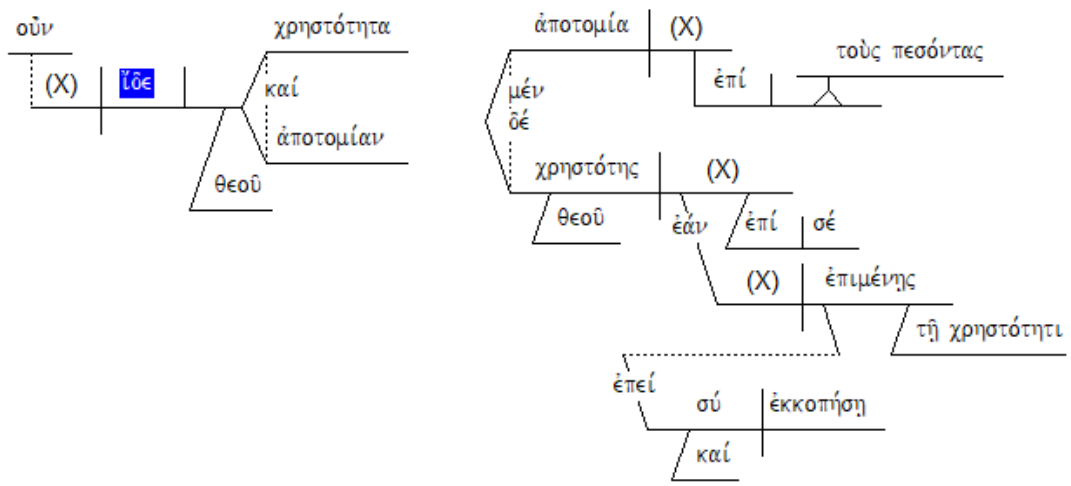

Rom 11:23

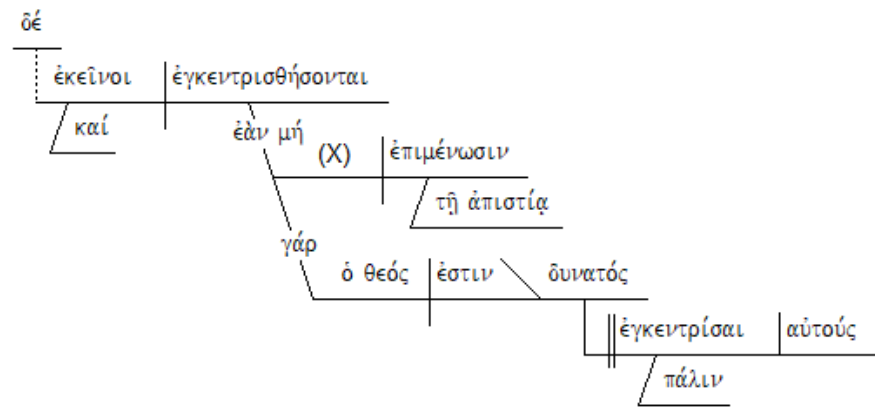

Rom 11:24

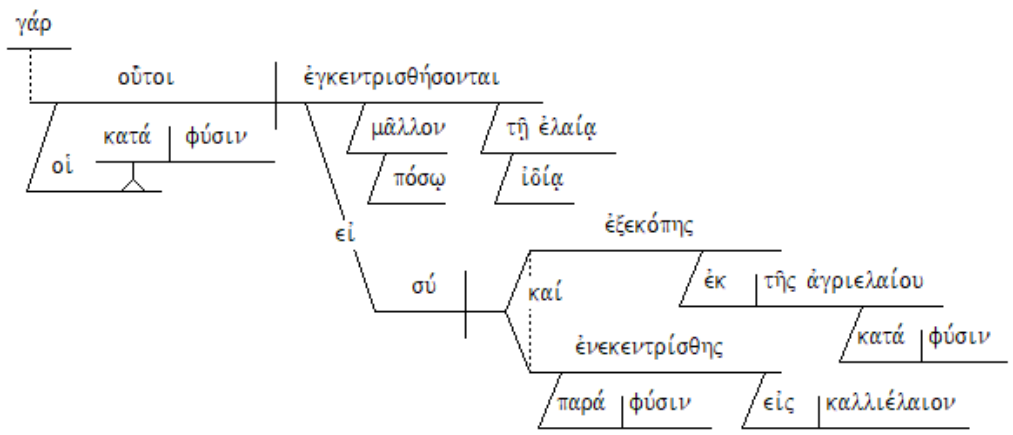

Frank Thielman:

- 11a Rhetorical Question **I say, then, they did not stumble so as to fall did they?**
- b Exclamation **Certainly not!**
- c Means Rather, **by their trespass**
Contrast (to 11a) **salvation has come to the gentiles,**
- d Purpose (of 11c) **in order to provoke the rest of Israel to jealousy.**
- 12a Restatement (of 11c) Now **if their transgression is wealth for the world and**
b Restatement (of 11c) **their defeat is wealth for the gentiles,**
c Inference **how much more their fullness!**
(from 11a-c)
- 13a Assertion Now **to you gentiles I speak.**
- b Condition (of 13c) **To the degree that I am an apostle to the gentiles,**
c Assertion **I glorify my ministry**
- 14 Basis (for 13c) **in the hope that perhaps I might somehow** provoke my kinfolk to emulation and
save some of them.
- 15 Basis (for 14) For **if their casting away is the reconciliation of the world,**
what will their acceptance be except life from the dead?
- 16a Restatement (of 15) And **if the first fruit is holy,**
the dough is also.
- b Introduction (to 17-24) And **if the root is holy,**
the branches are also.
- 17a Contrast (to 16b) But **if some of the branches have been broken off, and**
Condition (of 18a) **you, although a wild olive branch,** have been grafted in among them and
b Contra-expectation **have become a sharer of the silliness of the root of the olive tree ...**
c Condition (of 18a)
- 18a Exhortation **Do not boast over the branches.**
- b Warning But **if you boast ...**
you do not support the root, but
the root you.

- 19a Assertion **You will say, then,** "Branches were broken off
 b Purpose (of 19a) that I might be grafted in."
- 20a Assertion Very well. **They were broken off** because of unbelief,
 b Contrast and **you stand because of faith.**
 c Exhortation **Do not think haughty things, but fear.**
- 21 Basis (for 20c) For if God did not spare the natural branches, perhaps
he will not spare you either.
- 22a Exhortation **Note then the** kindness and
 strictness of God.
 b Explanation (of 22a) toward those who fell,
 strictness,
 c Contrast (with 22b) but toward you,
 the kindness of God
 Condition (of 22c) —if you remain within that kindness,
 d Warning since otherwise you will be cut off.
- 23a Assertion And **those** too, if they do not remain in their unbelief, **will be grafted in,**
 b Basis (of 23a) for **God is able to graft them in again.**
- 24a Explanation (of 23b) For if you were, according to your nature, cut from a wild olive tree and
 contrary to nature were grafted into a cultivated olive tree,
 b Inference (from 24a) **will these,** how much more
the natural branches, be grafted into their own tree.

TEXT: ROMANS 11:25-32

TITLE: ISRAEL'S FINAL SALVATION – REJECTION ONLY TEMPORARY

BIG IDEA:

**GOD'S REJECTION OF THE NATION ISRAEL IS NOT FINAL --
ALL ISRAEL WILL BE SAVED AFTER THE FULLNESS OF THE GENTILES**

INTRODUCTION:

Greg Herrick: It is quite likely that many Gentiles, observing Israel's disobedience, would conclude that they were wiser than the Jews (**11:18**), for they (saved Gentiles in Rome) had indeed responded properly and in faith toward the Messiah. But, Paul wants to tell them that they know not the whole story and that such ignorance may lead to conceit. What they could not have known, as it was a mystery, was that Israel as a whole had been hardened by God for a time (she will someday be saved) in order that God might save the Gentiles. But she will, at the second advent, enter into all the spiritual and material blessings promised her by the prophets (cf. **Dunn**, 690; **Witmer**, 485).

Warren Wiersbe: What has happened to Israel is all a part of God's plan, and He knows what He is doing. The blinding (or *hardening*, **Rom. 11:7**) of Israel as a nation is neither total nor final: it is partial and temporary. How long will it last? "*Until the fullness of the Gentiles be come in*" (**Rom. 11:25**). There is a "*fullness*" for Israel; (**Rom. 11:12**) and for the Gentiles. Today, God in His grace is visiting the Gentiles and taking out a people for His name (**Acts 15:12-14**). Individual Jews are being saved, of course, but this present age is primarily a time when God is visiting the Gentiles and building His church. When this present age has run its course, and the fullness of the Gentiles has come in, then God will once more deal with the nation of Israel.

John Walvoord: "*the times of the Gentiles*" vs. "*the fullness of the Gentiles*" --

When the two concepts, *the times of the Gentiles* and *the fullness of the Gentiles* are compared, it becomes evident that *the times of the Gentiles* is primarily a political term and has to do with the political overlordship of Jerusalem. By contrast, the term *the fullness of the Gentiles* refers to the present age in which Gentiles predominate in the church and far exceed Israel in present spiritual blessing. It becomes clear, therefore, that, while the two concepts may be contemporaneous at least for much of their fulfillment, the **termini** of the two periods are somewhat different.

The times of the Gentiles will end only when Israel will permanently gain political control of Jerusalem at the second advent of Christ, whereas *the fullness of the Gentiles* will be completed when God's present task of winning Jew and Gentile to Christ is completed. ("*The Times of the Gentiles*". *Bibl Sac* Vol 125. Issue 497. Page 9, 1968) (See **Walvoord's** article *The Times of the Gentiles*)

William Barclay: Paul is coming to the end of his argument. He has faced a bewildering, and, for a Jew, a heartbreaking situation. Somehow he has had to find an explanation of the fact that God's people rejected his Son when he came into the world. Paul never shut his eyes to that tragic fact, but he found a way in which the whole tragic situation could be fitted into the plan of

God. It is true that the Jews rejected Christ; but, as Paul saw it, that rejection happened in order that Christ might be offered to the Gentiles. To maintain the sovereignty of God's purpose, Paul even went the length of saying that it was he himself who hardened the hearts of the Jews in order to open a way to the Gentiles; but, even then, however contradictory it might sound, he still insisted on the personal responsibility of the Jews for their failure to accept God's offer. Paul held fast at one and the same time to divine sovereignty and human responsibility. But now comes the note of hope. His argument is a little complicated... (**Romans 11** - *William Barclay's Daily Study Bible*)

I. (:25-27) GOD WILL EVENTUALLY SAVE ALL ETHNIC ISRAEL

A. (:25a) Antidote for Pride = Understanding God's Revealed Mystery

“For I do not want you, brethren, to be uninformed of this mystery, lest you be wise in your own estimation,”

Thomas Schreiner: The importance of **verse 25** is signaled by the words οὐ γὰρ θέλω ὑμᾶς ἀγνοεῖν (*ou gar thelō hymas agnoein, for I do not want you to be ignorant*), which are used to introduce matters of **special importance** (cf. **Rom. 1:13; 1 Cor. 10:1; 12:1; 2 Cor. 1:8; 1 Thess. 4:13**). . . The mystery is divulged so that the gentiles will not become proud and give glory to themselves rather than to the glorious and infinitely wise God. . .

The mystery is at least threefold:

- (1) A part of Israel is hardened for a limited period of time,
- (2) the salvation of the gentiles will precede the salvation of Israel, and
- (3) all Israel will eventually be saved.

D. Moo (1996: 716) rightly observes that the focal point of the mystery is the **timing and manner of Israel's salvation**: Israel will be saved after the inclusion of the gentiles (so also **J. Wagner** 2002: 277).

Steven Cole: The matters we are dealing with here are prophetic revelation, not theological speculation. . . The prophetic revelation concerns God's sovereign, powerful working in salvation history.

Greg Herrick: The purpose then for which Paul is expounding this mystery is to prevent pride and to bring about humility on the part of the Gentile believers in Rome.

Frank Thielman: Here Paul backs up his admonition to humility by revealing a “*mystery*” (μυστήριον) to the Christians in Rome. Although he uses this term in Romans only here and in **16:25**, it is a characteristically Pauline word, appearing far more often in his writings than elsewhere in early Christian literature. Elsewhere Paul connects the term with prophecy (**1 Cor 13:2; Eph 3:4–5**) and with God's revelation to people of how the final stage of history is unfolding (**1 Cor 2:7**) and will unfold (**1 Cor 15:51; Eph 1:9–10; 2 Thess 2:7**). He also implies that “*mysteries*” contain information that would remain unknown had not God graciously revealed it to his people (**Rom 16:25; 1 Cor 2:7; Eph 3:9; Col 1:26**; cf. **1 Cor 14:2**) through his messengers (**1 Cor 4:1; Eph 3:3–4**). The mystery Paul reveals here describes the order of events before “*the deliverer*” comes “*from Zion*” (**11:26**). . .

“wise in your own estimation” -- In this context, however, where Paul has just engaged in a fictional dialogue with a gentile Christian who tends to “boast over” Israel’s rejection of the gospel (11:18–19) and “think [φρονεῖν] haughty things” (11:20), it clearly refers to people **thinking that they are wiser than they are** (cf. 12:3, 16).

James Dunn: Paul’s claim is that God had resolved the puzzle of Israel’s failure by revealing to him that Israel’s fall always had been part of God’s purpose for the climax of history.

B. (:25b) End Point of Israel’s Temporary Partial Hardening = *Fulness of the Gentiles*
“that a partial hardening has happened to Israel
until the fulness of the Gentiles has come in,”

Frank Thielman: The picture Paul draws of **the course the gospel will take** from his own time to the final day, then, is relatively clear up to this point in the argument. The gospel will find an important but limited response among Israelites in Paul’s time (11:5–7), but will have more success among gentiles (11:11, 15a). As the gospel is preached to the gentiles, even in Paul’s own time, some Jews will also continue to believe (11:14), and presumably that number will grow with the passing of time as some Jews whose “minds were hardened” (ἐπωρώθη) turn to the Lord and have the veil covering their spiritual sight lifted (2 Cor 3:14–16). Israel will continue to be divided into believing and unbelieving parts, however, until the mission to the gentiles is complete, and all those gentiles destined to believe the gospel have done so (11:25). Paul will say next what the argument has now made obvious.

John MacArthur: A **mystery** is something that's been hidden in the past and is now revealed in the Scripture. And what was hidden in the past was that Israel would be set aside, cut off from blessing, Gentiles grafted in, ultimately Gentiles cut off, and Israel grafted back in to the place of blessing. That mystery we are not to be ignorant of. That mystery has now been revealed through the apostle Paul. And what is the mystery specifically? It's given right in the verse, the two-part mystery, that *blindness in part is happened to Israel*. The mystery is that the Jews would not believe. And the word “blindness,” by the way, is really the word “hardened.” It's the word hardened, resistant. Blindness in part; notice he puts that “in part” in there? Why? Because their blindness was what? **Partial**. We've been saying it all along. That doesn't mean that the individuals were partly blind; it's not talking about the degree of blindness. What it means is that the nation was partly blind, that is, there were some who were not blind. There was always a what? **A believing remnant**, a believing remnant.

So, he says blindness in part is happened to Israel. And that was the point of the first **ten verses** of **chapter 11**, to show that their blindness was only partial and God had a remnant. Secondly, it was not only partial it was what? **Passing**. And that's how the second feature is given, only until the fullness of the Gentiles be come in. “*Until*” indicates time. “*Fullness*” indicates number of completion. And so, only until a certain time and a certain completion; therefore it's only temporary. **So the mystery was that Israel was set aside partially and temporarily**. The Jew in the Old Testament never saw that. He saw the nation Israel going along as the blessed people of God and someday the Messiah would come and establish His kingdom. He didn't see their total rejection and their being cut off the place of blessing and a new country or a new nation or a

new people, a new ethnos being grafted in, the church, and then becoming the source of witness in the world. And then they being cut off by apostasy and the Jew being grafted back in when the fullness of the Gentiles had come in. And that's the mystery that Paul is unfolding.

C. (:26a) Consummation of God's Redemptive Program for Ethnic Israel

"and thus all Israel will be saved;"

Frank Thielman: Interpreters have sometimes understood "*Israel*" here to refer to the multiethnic group of believers in Christ. Elsewhere, Paul assumes continuity between ancient Israel and Christians, regardless of their ethnicity (cf. **Rom 4:1; 1 Cor 10:1; Gal 6:16; Phil 3:3**). But the term "*Israel*" as Paul uses it here must refer to the **same group** that he identifies in **11:28** as both "*enemies*" and "*beloved*," and that group must be **unbelieving Israel**.

Thomas Schreiner: It is obvious in **verse 25** that the term "*Israel*" refers to **ethnic Israel** as distinguished from the gentiles. Thus it is extremely unlikely that the term "*Israel*" would have a different meaning in **verse 26** than it did in **verse 25** without a clear explanation by Paul that he was shifting the meaning. This is confirmed by **verse 28**, for the contrast with gentiles in that verse (ethnic Israel are "*enemies for the sake of the gentiles*" and yet "*beloved because of the fathers*") demonstrates that ethnic Israel must be in view in **verse 26** (so **Hafemann** 1988: 53). Even in the olive tree illustration (**11:17–24**), Jewish and gentile branches continue to be distinguished (**Das** 2003: 107). . .

most commentators agree that the term $\pi\acute{\alpha}\varsigma$ Ἰσραήλ should not be pressed to include every single Jew without exception. The term designates the majority of Jews. But what is remarkable here is the promise that Israel will be **saved as a people** (rightly **Hvalvik** 1990: 101). . .

All Israel represents a **dramatic future salvation for Israel** . . . [not the remnant-throughout-history interpretation] -- **11:11–24** intimates that something more than the salvation of the remnant awaits Israel. As **Das** (2003: 108) says, "Throughout the Hebrew Scriptures the remnant within Israel was always a sign of hope for Israel as a whole." The salvation of the remnant is partial, but Paul expects the "*fullness*" ($\pi\lambda\acute{\eta}\rho\omega\mu\alpha$, *plērōma*, **11:12**) of salvation for Israel and an "*acceptance*" ($\pi\rho\acute{o}\sigma\lambda\eta\mu\upsilon\varsigma$, *proslēmpsis*, **v. 15**) that **outstrips** anything that has occurred thus far. Similarly, the parable of the olive tree concludes with the expectation that the severed branches will be grafted on again, suggesting that a **great number of Jews** will turn back to Christ in faith. As **Das** (2003: 108) observes, the salvation of only a remnant isn't the solution; it is actually the problem that called forth these chapters in the first place.

Bruce Hurt: *The Bible Knowledge Commentary* notes that *All Israel will be saved* does not mean that every Jew living at Christ's return will be regenerated. Many of them will not be saved, as seen by the fact that the judgment of Israel, to follow soon after the Lord's return, will include the removal of Jewish rebels (**Ezekiel 20:34, 35, 36, 37, 38**). Following this judgment God will then remove godlessness and sins from the nation as He establishes His New Covenant with regenerate Israel (cf. **Jer. 31:33-34**). (**Walvoord, J. F., Zuck, R. B.**, et al: *The Bible Knowledge Commentary*. 1985. Victor)

R. Kent Hughes: No matter how insurmountable the difficulties, the land and the people will one day be reunited, and Israel will fulfill its destiny in Palestine.

D. (:26b-27) Prophetic Confirmation of God's Covenant Commitment to Israel

1. (:26b) Role of the Deliverer in Removing Ungodliness

“just as it is written,”

Greg Herrick: As sure as Israel's hardening was God's sovereign choice (cf. **11:7**), so also is her ultimate salvation and restoration. God, according to His time and initiative, will send the Deliverer and fulfill His covenant with the nation as a whole. These promises he made with the nation primarily through Isaiah and Jeremiah.

a. Testified Ethnicity

“The Deliverer will come from Zion,”

James Dunn: What role Christ's return would actually play in the end events is by no means clear, not least how it would *“turn away ungodliness from Jacob”* and how this fitted in with Israel's being provoked to jealousy by the gentile influx. But a lack of clarity and precision on the interrelation of the end events is a feature of the early Christian eschatology and Paul presumably was no wiser on these matters. His contribution to the early Christian eschatological thought at this point is simply in the revelation given to him that Israel's salvation is to be the climax of salvation-history, not a precise schedule or agenda of coming events.

b. Transformative Restoration

“He will remove ungodliness from Jacob.”

Greg Herrick: The salvation spoken of here for the Jews is not deliverance from her enemies at the return of Christ, but rather **spiritual salvation**. However, as Paul goes on to affirm, through Isaiah, this salvation will only come and be concomitant with her political deliverance through the Deliverer. Therefore, Israel's final restoration to God is both spiritual and political and according to God's gracious covenant with them (**Gen.12:1-3; Dt. 30:1-10; Jer.31:31-34**; contra **Cranfield**, 578).

Grant Osborne: The mention of **Jacob** seems to indicate that Paul has primarily the actual descendants of Abraham in mind, rather than the broader spiritual Israel of whom he had spoken previously.

2. (:27) Realization of Covenant Promise of Forgiveness of Sins

*“And this is My covenant with them,
When I take away their sins.”*

Frank Thielman: The salvation of Israel will happen in close proximity to the time when Jesus, the Son of David and Israel's Messiah, comes again. He will deliver Israel from the wrath of God against sin and transform it into a society of justice and peace.

Paul supports his claim that all Israel will be saved with a composite quotation from **Isaiah 59:20–21a** and **27:9a**. **Isaiah 59** is part of an indictment against Israel for its sins, “*which have made a separation between*” Israel and God (**59:2**). The first section of the chapter details Israel’s sins, especially the violence, deceit, and legal injustice that characterized Israelite society (**59:1–8**). The second section is a confession that these charges are true (**59:9–15a**). The final section describes how God will come to establish the justice he had sought from his people and how he will do this, in part, by turning his people away from their impiety (**59:15b–21**).

For Paul, “*the deliverer*” (ὁ ῥυόμενος) who accomplishes this is Christ himself at his second coming (cf. **1 Thess 1:10**). In the Hebrew text of **Isaiah 59:20**, he will come “*to*” (*le*) Zion, and in the LXX text he will come “*for the sake of*” (ἕνεκεν) Zion, but in Paul’s text he will come “*from*” (ἐκ) Zion. Paul may have intended by this change to emphasize the **Jewishness** of Jesus: that, for example, he came “*from* [ἐκ] *David’s offspring*” (**Rom 1:3**) and “*from*” (ἐξ) Israel (**Rom 9:5**).

The deliverance Christ will bring to Israel involves not only salvation from the wrath of God (**Rom 11:26a**; cf. **1 Thess 1:10**), but a **transformation of society** so that violence, deceit, and injustice no longer characterize it. According to Isaiah, this transformation will be accompanied by a covenant between God and his people that involves God enabling his people, by means of his Spirit, to communicate his revelation of himself to future generations (**Isa 59:21b**).

Immediately after citing Isaiah’s reference to “*this . . . covenant*” and before the prophet describes God’s covenant with Israel this way, Paul switches his attention to another part of Isaiah that allows him to describe God’s future covenant with Israel as one that takes away Israel’s various sins (**Isa 27:9a**). Paul may especially have had in mind the sinful behavior he attributed to Israel in **3:10–18**, where he quoted **Isaiah 59:7–8** (see **Rom 3:15–16**). He may also have been thinking of the sort of violence and injustice that some Jews used against the proclamation of the gospel (**1 Thess 2:14–16**; cf. **Rom 11:3**). Rather than a place where such “*transgressions are multiplied*” (**Isa 59:12**), Paul envisions a future Israel that will cultivate peace and justice (cf. **59:8**).

Steven Cole: The forgiveness of sins is the primary need of every person --

Romans 11:27: “*This is My covenant with them, when I take away their sins.*” Paul combines **Isaiah 59:21** and **27:9** (see **Moo**, p. 729). “*I take away their sins*” reminds us that salvation is not primarily a psychological matter of moving from low self-esteem to proper self-esteem, as **Robert Schuller** claims. Nor is it a matter of Jesus helping you to succeed in your family life or career. Salvation meets our fundamental need to be reconciled with the holy God through His just forgiveness of all our sins through the death of Christ (**Rom. 3:26**).

II. (:28-29) GOD REMAINS COMMITTED TO ETHNIC ISRAEL

Greg Herrick: At this point, Paul begins to draw out and summarize the implications of all that he has just affirmed in **vv.25-27** (**Cranfield**, 579). Again, he affirms that Israel has been set aside so that mercy may come to the Gentiles (cf. **11:11,12,15**; **Murray**, 100). But, because God has called her into existence through the patriarchs, He will most definitely fulfill His purpose for

her. First, Paul deals with Israel's present relation to the progress of the gospel and second, he relates all that he has said in **25-27** to God's wonderful purpose of granting mercy to all.

A. (:28) Commitment Based on Sovereign Election and Divine Love

1. Enemies Currently

*“From the standpoint of the gospel
they are enemies for your sake,”*

Greg Herrick: Therefore, since it is only for a time, the phrase according to the gospel must mean **according to the progress of the gospel**. That is, they are enemies at this time in the progress of carrying out of the gospel in the world, but in the future it will be this very same message that will save them as well (cf. **Cranfield**, 579). That the idea of time or progress is inherent in the according to (*katav*) preposition is even clearer when we consider the heavy emphasis on the element of time in this paragraph (cf. "*until*") and indeed in the whole segment (**9-11**). So Paul says they are enemies for a time for your sake. This final phrase affirms that it was for the salvation of the Gentiles that Israel was hardened and is now considered an enemy by God (**Bruce**, 222; **Murray**, 100).

Grant Osborne: As far as the **gospel** is concerned, they are enemies on your account. Paul is still speaking to the Gentiles in his audience (**11:13**). In order for God to bring the gospel to them, he had to set the Jews aside—as if they were his enemies for having rejected the Good News.

As far as **election** is concerned, they are loved on account of the patriarchs. But as far as God's choice, his election, is concerned, Israel is loved by God because of his covenants with the patriarchs—Abraham, Isaac, and Jacob. Because God chose those men through whom he would carry out his promises, he will keep his promises to their descendants.

2. Endeared Ultimately

*“but from the standpoint of God's choice
they are beloved for the sake of the fathers;”*

Frank Thielman: It is true that unbelieving Israel is, at the moment, God's enemy, but two qualifications temper the enmity between them. This enmity has a saving purpose, and it will one day yield to the fulfillment of God's loving commitment to Israel's forebears.

Greg Herrick: All that Paul is saying is that God chose to freely bestow His love on the fathers and gave them promises to which He will remain faithful.

B. (:29) Commitment Based on the Faithfulness of God

“for the gifts and the calling of God are irrevocable.”

John MacArthur: So, Paul here is seeing not only the **sovereignty** of God as he works history to the salvation of Israel, but the **integrity** of God as He fulfills His promise. He has the integrity to keep His word. So we do not judge God by the standard of men. We don't worry about whether God can pull the plan off. And we don't worry whether God can keep His promise, like

we do about men, because God is a covenant-keeping God who is absolutely sovereign. And those two fit together so beautifully.

Greg Herrick: That God will indeed be faithful is clear for *the gifts and call of God are irrevocable*. The term *for (gavr)* indicates that Paul is now giving the reason as to why Israel is still beloved by God. She is so, because God has purposed to bless her. The *gifts (carivsmata)* spoken of here refer to those enumerated in **9:4, 5** (Murray, 101; Black, 163) which include the privileges mentioned therein. Israel will experience final adoption, Divine glory, temple worship (cf. **Ezek. 40-48**), the promises and abundant blessings through Christ in the Millennial reign. It depends upon the faithfulness of God (**3:3; Num.23:19**). The *call (klh `si')* of God or God's calling refers to His bringing into existence and preservation of the nation for a special purpose and role in history (Cranfield, 581). Not only did Yahweh create her to bring forth the Messiah (**Gen.12:3**), but He also used her in many ways, perhaps not the least of which is as a demonstration to Satan that He is in fact in control of the destiny of this planet. Israel's gifts and calling, Paul says, are *irrevocable (ajmetamevlhta)*; something God will never change His mind on or regret. The term occurs only one other time in the N.T., in **2 Cor. 7:10** where it is used to refer to a person who does not regret experiencing sorrow that leads to salvation. It carries the same meaning in extra-biblical writings. Here Paul places the word first in it's clause, in order to emphasize his point regarding God's unwavering commitment to Israel.

James Dunn: God is faithful to the covenant relationship he first established with Abraham and his seed. God has not withdrawn from the commitment to Israel into which he entered at his own initiative. The word “*irrevocable*” is given particular emphasis, not as a description of God’s character or dealings in general, but with specific reference to his purpose of salvation. He who foresees the end from the beginning does not need to tailor his election to the changing circumstances of Israel’s belief and unbelief; rather the course pursued by Israel has to be seen as falling within that original election, part of the original purpose.

III. (:30-32) GOD DELIGHTS IN SHOWING MERCY TO THE DISOBEDIENT = THE HEART OF HIS REDEMPTIVE PLAN FOR BOTH JEWS AND GENTILES

A. (:30-31) Mercy for Both Disobedient Gentiles and Jews

1. (:30) For Gentiles

*“For just as you once were disobedient to God,
but now have been shown mercy because of their disobedience,”*

2. (:31) For Jews

*“so these also now have been disobedient, in order that
because of the mercy shown to you they also may now be shown mercy.”*

Frank Thielman: God will actually use Israel’s disobedience as the means by which he will, in the end, be faithful to his promises to them. Their disobedience has opened a door of opportunity for gentiles to hear and believe the gospel, but this influx of gentiles into God’s people will eventually result in God’s mercy flowing to all Israel as well. . .

His “*now*” here in **11:31**, therefore, refers to the **closing period of history** in which he understood himself to be living, a period that included both the proclamation of the gospel to the gentiles and, **eventually, Israel’s salvation**.

Greg Herrick: The problem in this passage revolves around the second *now*. The whole point of what Paul has been saying is that at the present time (if *now* be understood chronologically) Israel has not been shown mercy. Does this *now* contradict that? Some take the *now* to refer to the availability of blessing to Israel at any time, even *now* (**Black**, 163). But this minimizes the **eschatological** nature of the blessing to come to Israel that Paul has so emphasized in this passage. A better way to see the *now* is to regard it as a **logical, eschatological *now***. That is, because of what God is doing with the Gentiles, *now* (i.e. thus or as a result) Israel may receive mercy. In other words, *now* that God has been merciful to the Gentiles, He can logically turn back to the Jews. Israel will experience this mercy at the *parousia* (cf. **Cranfield**, 586).

Grant Osborne: In these verses, Paul shows how **the Jews and the Gentiles benefit each other**. Whenever God shows mercy to one group, the other shares the blessing. In God’s original plan, the Jews would be the source of God’s blessing to the Gentiles (see **Genesis 12:3**). When the Jews neglected this mission, God blessed the Gentiles anyway through the Jewish Messiah. He still maintained his love for the Jews because of his promises to Abraham, Isaac, and Jacob (“*on account of the patriarchs*”). But someday the faithful Jews will share in God’s mercy. God’s plans will not be thwarted; he will “*have mercy on them all*” (**11:32**).

James Dunn: For what Paul calls Jewish disobedience would be regarded by most of his Jewish contemporaries as Jewish obedience. So the **turning of the tables** is by no means simply a case of Jew and Gentile exchanging roles, but also of Jewish misunderstanding being set right thereby. Paul’s confident hope is that the fact of “*disobedient*” Gentiles receiving mercy will shock his fellow Jews into a recognition that their “*obedience*” is in fact disobedience to the word of faith (**10:16, 21**). By coming to see that their exclusive claim to God’s covenanted mercy was what was actually disqualifying them from that mercy, they would become open once again to receiving that mercy as sheer mercy, mercy to the disobedient. This interaction of Jewish disobedience, resulting in Gentiles receiving mercy, resulting in Jews at large receiving the same mercy, is already in play, part of the eschatological “*now*” already in train, and shortly to reach its consummation just as soon as the sound of the gospel already winging its way to the limits of the inhabited world (**10:18**) has resulted in the incoming of the full number of Gentiles.

B. (:32) Mercy for All Disobedient God’s Elect

“For God has shut up all in disobedience that He might show mercy to all.”

Frank Thielman: In the gospel, God has demonstrated definitively that both Jews and Gentiles have been disobedient to him, and he has demonstrated this so that Jews and Gentiles alike might receive his merciful forgiveness for their disobedience. . .

Since Paul’s “*all*” occurs in a context where the discussion has focused on the different roles that **various people groups** have played and will play in God’s historical purposes, it refers not to every individual but to **all kinds of people**, whether Israelites or non-Israelites.

Everett Harrision: The conclusion of the whole matter is that God magnified his mercy by the very fact of disobedience, binding all men over to it (cf. **3:9**) that he might have mercy on all. So disobedience does not have the last word (cf. **Gal 3:22**).

James Dunn: God has confined human beings to disobedience precisely because it is only to the disobedient that he can show mercy. Men and women cannot receive God's mercy so long as they rely on anything else, their own wisdom or status (by virtue of ethnic identity or cultic practice), so long as they think they are being obedient. To shut them up in disobedience is to bring home to them their own creatureliness, is to open them to mercy.

Thomas Schreiner: The revisiting of mercy on Israel after such an interval serves to remind Israel that God's saving favor is truly mercy, not something they deserve because of their ethnic heritage. Just as God has chosen to extend mercy to the gentiles in the present era, so too in conformity with his ancient promises he pledges to shower his grace on Israel again in the future.

John MacArthur: Another thing that is cause for us to praise God, and this is such a wonderful glorious truth is God's **generosity**. And the key word in this section, **verses 30 to 32**, is the word "*mercy*." It's used several times. "*For as ye in time past have not believed God yet now have obtained mercy through their unbelief, even so have these also now not believed that through Your mercy they also may obtain mercy, for God hath included them all in unbelief that He might have mercy upon all.*" Now the word "*mercy*" speaks of God's generosity. It implies here that salvation is not something we deserve but something we don't deserve, undeserved goodness. Mercy is God withholding punishment when it is deserved. Mercy is God granting forgiveness when it is not deserved. Mercy is tender compassion and love.

* * * * *

DEVOTIONAL QUESTIONS:

- 1) Does studying biblical prophecy humble you and burden you for the lost or does it puff you up with pride?
- 2) Do your circumstances ever cause you to doubt God's promises?
- 3) Are we overwhelmed with awe at the display of God's mercy and the magnification of His glory?
- 4) What are the implications of the revelation here that those who are hardened in unbelief are actually "*enemies*" of God?

* * * * *

QUOTES FOR REFLECTION:

John Piper: Four broad stages of history (11:30-32):

(1) The time of Gentile disobedience, when God permitted the nations to go their own way. God described some of this history in advance to Abraham in a mind-boggling statement (**Gen. 15:13**): “*God said to Abram, ‘Know for certain that your descendants will be strangers in a land that is not theirs, where they will be enslaved and oppressed four hundred years.’*” Then God explains why Israel will spend four centuries in slavery in Egypt (**Gen. 15:16**), “*Then in the fourth generation they will return here, for the iniquity of the Amorite is not yet complete.*” That’s amazing! Israel would spend four long centuries in slavery because the iniquity of the Amorite (the Canaanites) was not yet complete! When their sin was full to the brim, God freed Israel from slavery to Egypt and commanded them to execute His judgment on the wicked Canaanites.

Paul referred to this time of Gentile disobedience in a passing phrase in a sermon at Lystra (**Acts 14:16**), “*In the generations gone by He permitted all the nations to go their own ways*” I thought about that verse on Monday as we hiked to a remote spot below the North Rim of the Grand Canyon called “Shaman’s Gallery.” It is an extensive panel of rock art that some native shaman who did not know the living and true God put there perhaps 1,000 years ago. Why didn’t he know God? Because in His unsearchable judgments and unfathomable ways, God permitted the Gentiles to go their own ways.

(2) The time of Jewish disobedience, when they rejected their Messiah and He gave them up to hardness. As we saw last time, Israel brazenly rejected and crucified their Savior as they cried out (**Matt. 27:25**), “*His blood shall be on us and on our children!*” Although God had ordained the cross, He permitted the Jews to make that frightening choice and pronounce that curse on them and their children. That hardness has lasted for almost 2,000 years.

When Paul says (**11:28**), “*From the standpoint of the gospel they are enemies for your sake,*” he means that because God hardened the Jews, the gospel has now gone out to the Gentiles (see **11:11, 12, 15**). “*Enemies*” probably means, “*They are God’s enemies*” because of their sin and unbelief in rejecting their Messiah. But the staggering thing about God’s judgment on the Jews is that if you had been born as a Jew in the past 2,000 years, unless you were a part of the remnant according to God’s gracious choice (**11:5**), you would have lived and died hardened toward the good news about the Savior!

(3) The time of mercy shown to the Gentiles through the spread of the gospel to all nations—the fullness of the Gentiles. We are the recipients of God’s mercy in this period as the gospel goes out to the nations. And yet, as I just mentioned in the case of the Native Americans who lived 1,000 years ago, they lived and died without hearing the gospel. Approximately 6,900 people groups are still in such spiritual darkness, waiting to hear the gospel.

(4) The time of mercy on Israel as God completes his redemptive plan and takes away the hardening and saves the nation of Israel with a mass conversion to Christ. As I explained

last week, this will probably happen either just prior to or at the time of the second coming of Jesus Christ.

Charles Hodge: [Eight Reasons](#) “*all Israel*” must refer to **ethnic Israel**:

1) The context favors the reference to the Jewish people as a whole.

Romans 11 teaches that the future conversion of Israel will be blessing to the whole world. It also speaks of the temporary hardening of Israel in the present age so that the Gentiles might be saved. Those statements make no sense unless Israel refers to the Jewish people.

2) Paul argues that the Jews will be restored in the same sense that they were rejected.

But Israel was rejected as a nation because its leaders rejected Christ. **Romans 11:15** says that their acceptance of Christ will be like a resurrection from the dead. National rejection in the past and the present will give way to national acceptance of Jesus in the future.

3) Paul anticipates a vast event (“*all Israel will be saved*” v. 26) that that will be world-shaking its impact.

This cannot refer to the small trickle of Jewish believers across the centuries or even the growing stream of Jewish believers today. Paul’s words picture a tidal wave of Jews coming to Christ when he returns to the earth in power and great glory.

4) When Paul says, “*I do not want you to be ignorant*” (v. 25), he uses a phrase that introduces a truth that they had not previously known.

From the very beginning some Jews followed Jesus as their promised Messiah. The earliest Christian church was entirely Jewish, but as the gospel spread, the percentage of Jews to Gentiles in the church became progressively smaller, and it became clear that most Jews would not believe in Jesus. Since everyone knew there were some Jewish believers already, **vv. 26-28** can’t refer to that fact. This passage reveals a coming conversion of the Jewish people that has no parallel in Christian history. It must refer to a yet-future event of enormous proportions.

5) Paul even calls this truth of Israel’s future conversion a “mystery” in verse 25.

A “*mystery*” in the New Testament refers not to a secret, but to a truth once known only to God but now revealed to the world. The “*mystery*” can’t be that individual Jews are coming to Christ because that’s how the Christian movement started. The mystery is that “*all Israel will be saved*” at the Second Coming of Christ. That was a truly not previously revealed.

6) The term “*all Israel*” can’t refer only to “spiritual Israel” because in verse 25 he clearly distinguishes between unbelieving Israel and the Gentiles who are coming to Christ in this age.

Israel has experienced a “*hardening in part*,” meaning that most Jews don’t believe, but some do and they are saved. God allowed this hardening of the Jewish majority in this age so that the full number of the Gentile might be saved. **Thomas Constable** (*Romans notes*, p. 122) explains it this way:

When all the Gentiles whom God has chosen for salvation during the present age of Israel’s rejection have experienced salvation, God will precipitate a revival of faith within Israel.

The “Israel” that is partially hardened during this present age is the same “Israel” that will one day be saved.

7) The “until” sets a definite time limit in the future for Israel’s conversion. Think of this way:

Israel is mostly hardened against the Lord in this present age.
Meanwhile multitudes of Gentiles are coming to Christ.
God knows the number of elect Gentiles he is calling to Christ.
When that number is complete, Israel’s blindness will be removed.
That will happen when Jesus returns to the earth.

8) The following verses require this interpretation:

Isaiah 59:20 says the Redeemer will come to Zion and turn the people from their sins.

Isaiah 59:21 says this will happen in fulfillment of the covenant promise.

Isaiah 27:9 says that Jacob’s guilt (Israel’s sin) will be atoned for.

Zechariah 12:10-12 says the house of David will mourn for their sins when they look upon the one they pierced.

Zechariah 13:1 says that in the last days a fountain of forgiveness will be opened to the **“house of David and the inhabitants of Jerusalem.”**

Those promises form the basis of Paul’s argument in **Romans 11:28-29**. The Jews are still the object of God’s special love and care because his ancient promises cannot be broken. **“God’s gifts and his call are irrevocable” (v. 29).**

David Thompson: There are four reasons why God must finish His program with Israel:

Reason #1 - Because it is written in Scripture. **11:26a**

Isaiah 59:20-21 is quoted in **Romans 11:26-27**. Paul’s point here is that Israel will be saved because it is written in the Word of God that she will be saved. God cannot go back on His Word!

Reason #2 - Because it is a covenant of God. **11:27**

God must finish His program with Israel because He has made a covenant to do so. That word *“covenant”* has to do with a “legal document” which contains legal rights such as a will. This is much more than just some agreement between two parties; it carries with it the idea of a **legal binding obligation.**

The meaning here is that God has made a binding agreement with Israel and He is obligated to fulfill it. What is it that God must do? He must do what He says He will do or He cannot be God. When we turn to **Jeremiah 31:31-34**, especially **verses 35-37**, God states it is impossible for Israel to be cast off.

In **Hebrews 13:20-21**, we learn that this same God has made an everlasting covenant with every believer in Jesus Christ. We, like Israel, are part of God’s covenantal program. This is why we

cannot lose our salvation. For the same reason Israel cannot lose her land - God has entered into a legal pact with us and He will fulfill all of His promises to us, which includes everlasting life.

Reason #3 - Because it is an election of God. **11:28**

Paul says here that even though God has temporarily blinded Israel to the Gospel so that Gentiles might come to Christ, Israel is still part of God's elective purposes and she still is beloved by God. Israel has been, is, and always will be God's elect nation. She is God's choice.

The word "*choice*" or "*election*" scares many people, but actually it is this very word that saves people. Israel is God's chosen, elect nation - that is a fact. No human or any satanic power can change this reality. God will fulfill His promises because God has elected His nation.

Now remember **Romans 9:24** - God's elective purposes include individual Gentiles.

Reason #4 - Because of the immutability of God. **11:29**

God cannot ever go back on His promises or His Word because He is a God who cannot lie. God cannot change His grace gifts and He cannot change His elective purposes.

Salvation, according to **Ephesians 2:8-9**, is a gift God gave us. God saved us and it is impossible for Him to take this gift back.

There is also no hint in these verses that God will fulfill His program with Israel because Israel is faithful. The text abounds with the truth that God will fulfill this **because He is faithful to Himself**.

Why would God want a nation like Israel? Why would God stop a program with Israel to allow someone like us into His eternal plan? Frankly, why would God save anyone, Jew or Gentile?

The answer is found in verses **30-32** - **God did all of this to demonstrate His mercy** .

Greg Herrick: Israel's Present Hardening and Future Salvation

Subject: Saved Gentiles should not be proud concerning Israel's present failure to respond to God

Complement: because it is a Divine hardening that is only temporal, partial, and forms the basis for God's salvific blessings to them.

I. Saved Gentiles should not boast in themselves as they consider Israel's present rejection by God, because the nation as a whole has been divinely hardened for a time (25).

A. Paul does not want the Gentiles to think that they are intrinsically better in the sight of God than the Jews (**25a**).

B. God has temporarily and partially hardened national Israel, until the complete number of Gentiles is saved (**25b**).

II. The nation of Israel will be spiritually saved when God sends the Messiah as the deliverer who will cleanse Jacob according to His covenant with them (26, 27).

- A. National Israel will be spiritually saved after the complete number of Gentiles is saved (26a)
- B. Christ will return to the city of David and will turn them away from their iniquities (26b).
- C. Christ taking away Israel's sin is according to God's covenant with them as expressed by Jeremiah (27).

III. At this time in the progress of the gospel, national Israel is God's enemy, but because they were sovereignly chosen through promises given to the patriarchs, they will yet be saved (28, 29).

- A. At the present time national Israel rejects the gospel (28a)
- B. God will never regret, nor turn back His decision to choose and show mercy to Israel (28b, 29).

IV. While Israel has been disobedient to God, He has shown mercy to the Gentiles and because of this mercy He will again show mercy to Israel because this is His purpose (30-32)

- A. The Gentiles were shown mercy because of Israel's disobedience (30).
- B. God's mercy to the Gentiles will cause Him to show mercy to Israel (31).
- C. God has consigned all to disobedience so that He might show mercy to all men (32).

Conclusion: In this section Paul brings to a close his thoughts on the relation between the salvation of Israel and the Gentiles. Israel has been set aside for a time until God has finished his work of saving Gentiles, but will again be saved when the Deliverer, Christ, comes. God's plan is marvelous and Gentiles should not boast in respect to Israel's failure because it was a result of Divine hardening in order that having set aside Israel God might fully extend His salvation to the Gentiles.

APPLICATIONS

1. The sovereignty of God to choose whom He wishes challenges me to a life of fear and worship (cf. Paul's application **11:33-36**).
2. The fact that God will fulfill His purpose for Israel challenges me to believe Him for His will to be done in my life (cf. **Phil. 1:6**).
3. The purpose of God in history to be merciful really challenges me to spend more time on my knees with Him in thanksgiving.
4. The fact that Paul revealed a mystery in order to bring about humility challenges me to live a life of humility. In a sense all of the scripture is the revelation of a mystery: God and His ways. <https://bible.org/article/israels-present-hardening-and-future-salvation-exegesis-romans-1125-32>

Ray Pritchard: Implications of God's Immutability

1. First, God's promises do not change.
2. Second, God's purposes do not change.
3. Third, God's character does not change.

Leedy Greek NT Diagrams:

Rom 11:25-26

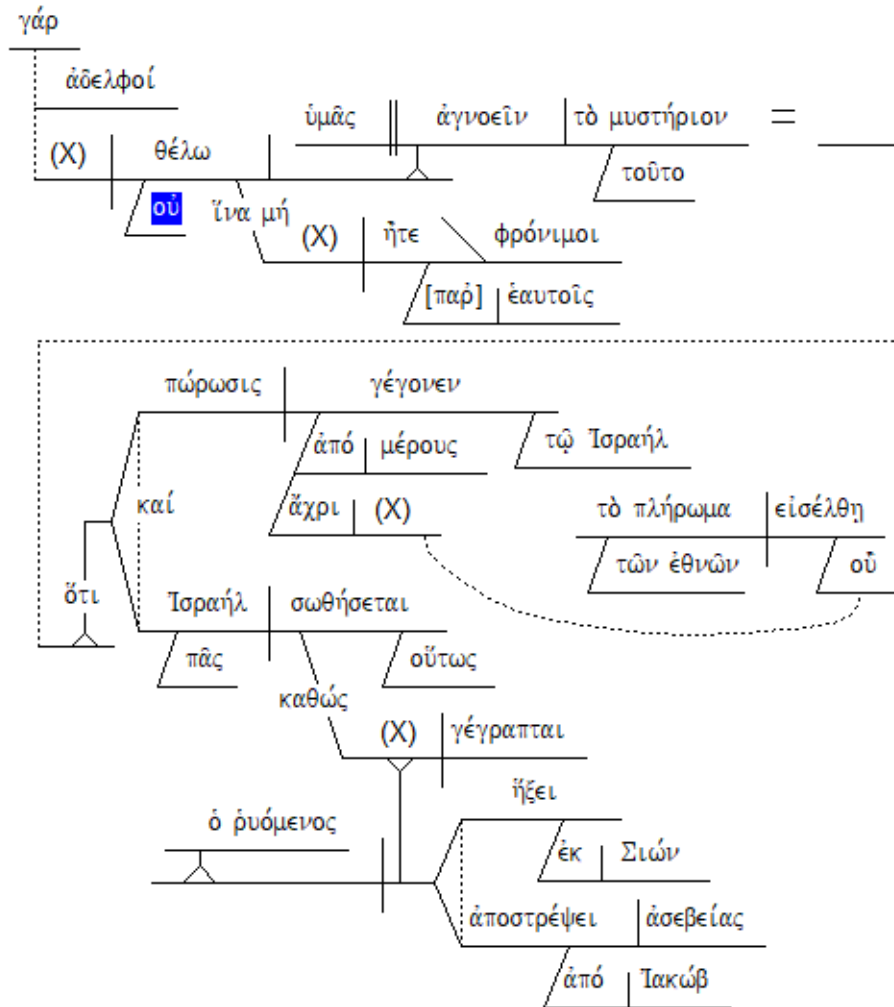

Rom 11:27

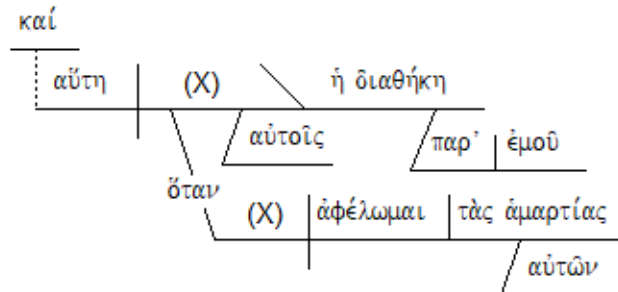

Rom 11:28-29

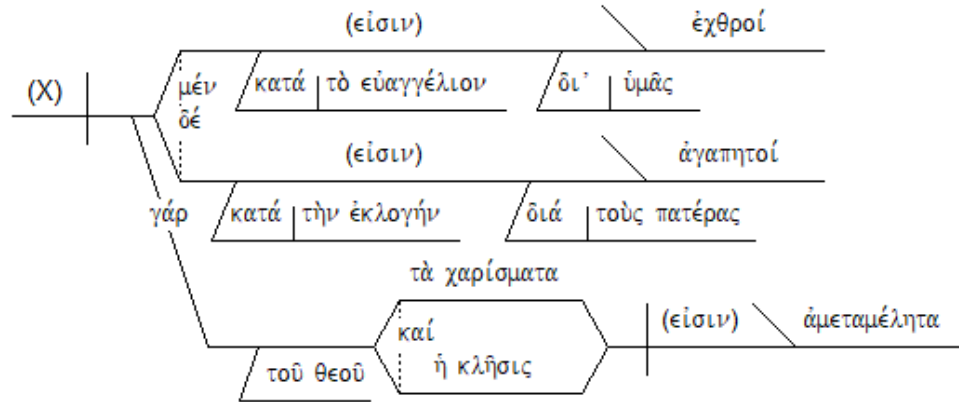

Rom 11:30-31

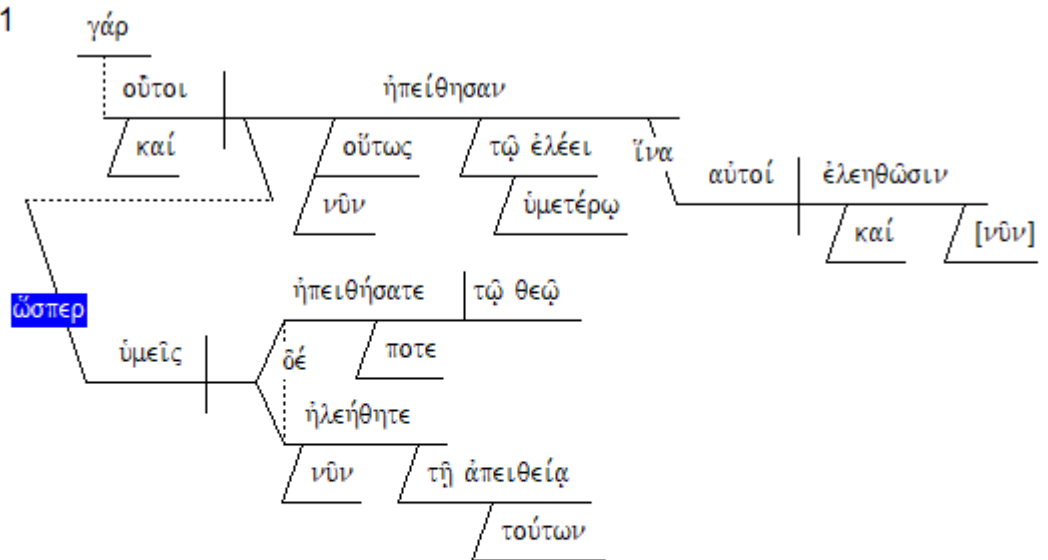

Rom 11:32

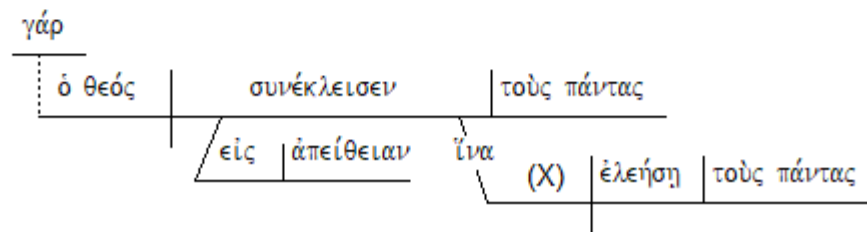

Frank Thielman:

- 25a Explanation (of 24b) For **I do not want you to be ignorant**, brothers and sisters, about this mystery
 b Purpose (of 25a) so that you might not be wise in your own estimation:
- c Content (of 25a) **a partial hardening has happened**
 to Israel
 until the fullness of the gentiles should come in.
- 26a Means/Sequence: And so, **all Israel will be saved**.
- 26b–27 Verification (of 26a) just as **it is written**,
 "The deliverer will come from Zion;
 he will turn impiety away from Jacob,
 and this will be my covenant with them (Isa 59:20–21a)
 when I do away with their sins." (Isa 27:9a)
- 28a Summary (of 11–27) According to the gospel,
 b Assertion **they are enemies**
 c Cause because of you.
- d Contrast but according to election
 e Assertion **they are beloved**
 f Cause because of the fathers.
- 29 Basis (for 28) For **God has no misgivings about his gifts and calling**.
- 30a Explanation (of 29) For just as you once disobeyed God,
 b Contrast (to 30a) but **now you were shown mercy**
 c Cause because of the disobedience of these,
- 31a Inference (from 30) so also **these disobeyed now**
 b Cause because of the mercy shown to you
 c Purpose (of 31a) in order that they also might now be shown mercy.
- 32a Summary (of 30–31) For **God has enclosed all people within disobedience**
 b Purpose of 32a in order that he might have mercy upon all people.

TEXT: ROMANS 11:33-36

TITLE: *THEOLOGY BURSTS FORTH IN DOXOLOGY – TO GOD BE THE GLORY!*

BIG IDEA:

**GOD'S GREAT PLAN OF SALVATION DESERVES OUR PRAISE
BECAUSE IT GLORIFIES GOD'S INSCRUTABILITY, AUTONOMY AND
SOVEREIGNTY**

INTRODUCTION:

Steven Lawson: Now, **verses 33 to 36** is what we call a **doxology**. A doxology is a short, condensed anthem of praise. It is theologically rich, it is emotionally charged, and it is filled with wonder and amazement that just comes pouring out of the heart of the Apostle Paul as he is astonished at this truth that he has just presented to us, and he wants you and me to be astonished as well. And so Paul really just opens up his heart and lets this praise for God come gushing out, really, like a mighty current of wonder and worship for God. And it is intended to cause our hearts to be ignited with worship for God. And I trust that as you've been a part of these studies with us that there has been this building momentum of excitement within your own soul for God and for what God has done in His gospel.

So as we look at this doxology which, I feel like I'm just putting my pinky into or a toe into the ocean of God's amazing grace. Let me just give you the **outline** for verses 33 to 36, and we probably will only be able to look at the first heading today.

- But in **verses 33 and 34**, I see "The Inscrutability of God."
- In **verse 35**, "The Autonomy of God."
- In **verse 36a**, "The Sovereignty of God,"
- and then finally in **36b**, "The Glory to God."

I think that is a helpful outline for us and as we look at this, I feel somewhat overwhelmed with what we have to deal with here.

Thomas Schreiner: The depth of God's saving plan, which reveals his saving righteousness, moves Paul to express his wonder in doxological language. The poetic cast of these verses is apparent. Wisdom and knowledge are ascribed to God.

James Dunn: The majestic vision of the full sweep of God's sovereign purpose of mercy in the final summary of the argument (**vv 25–32**) draws most fittingly from the apostle a paean of **praise to this God**. The nine-line hymn, which may well reflect its Corinthian origin, does not seek to penetrate more deeply into the mystery of God's purpose. Paul, having caught a glimpse of the **measureless majesty of God's mercy**, falls back in an awe and wonder which struggles to find expression.

Newell: The last four verses are in the nature of a doxology. The apostle's heart was filled with worship, praise, and admiration as the full blaze of the divine plan fills the horizon of his soul... Apart from revelation none can know God's mind, just as no created being could ever be His

counselor. No one ever earned grace by first giving to Him in order to earn a blessing; but *everything is from Him, and through Him, and to Him, to Whom be glory forever. Amen.*

Moule: Here, at the close of this discussion of the case of Israel,—in which he has held up for our submission the unfathomable mystery of electing sovereignty, and also the strange ways by which Divine judgment is often made the instrument of Divine mercy,—the Apostle turns to the Supreme Object of his thought and love, and utters his ascription of worship and praise to the All-Wise and Almighty. Such a doxology is perfectly in the manner of Scripture, in which the ultimate aim ever is not the glory, nor even the happiness, of Man, (dear as his happiness is to God and His messengers,) but the **Glory of God**.

John Piper: Education about God precedes and serves exultation in God. Learning truth precedes loving truth. Right reflection on God precedes right affection for God. Seeing the glory of Christ precedes savoring the glory of Christ. Good theology is the foundation of great doxology. Knowledge is utterly crucial. But it is not an end in itself. It serves faith and love. And if it doesn't, it only puffs up, as Paul says in **1Co 8:1**. Where education does not produce heartfelt exultation in God, it degenerates into proud intellectualism. And where exultation is not sustained and shaped by solid Biblical education, it degenerates into proud emotionalism. God means to be known and loved. Seen and savored. Pondered and praised.

Douglas Moo: Every good sermon has a conclusion that should stimulate its hearers to respond to the message. In **8:31–39** Paul concludes his “sermon” on Christian assurance in **chapters 5–8** by calling on his readers to exult in their security in Christ. Now in **11:33–36** he caps off his survey of salvation history by leading his readers in an expression of awe at God’s extraordinary plan for the world. As in **8:31–39**, the apostle uses questions to encourage us to identify with him in this outburst of amazement.

The praise to God Paul offers here falls into three strophes.

- In **verse 33**, we find three exclamations about God’s wise plan.
- In **verses 34–35**, the apostle uses three rhetorical questions to remind us how far above are the thoughts and ways of God.
- Finally, **verse 36** reminds us that God is ultimate in all things and that he is therefore deserving of our praise.

I. (:33-34) PRAISING GOD’S INSCRUTABILITY – HIS UNFATHOMABLE WISDOM AND KNOWLEDGE

A. Infinite Wisdom and Knowledge

“Oh, the depth of the riches both of the wisdom and knowledge of God!”

Thomas Schreiner: Most scholars understand the first καί (*kai, and*) in **verse 33** to be continuative, with the result that the three genitives πλούτου (*ploutou, riches*), σοφίας (*sophias, wisdom*), and γνώσεως (*gnōseōs, knowledge*) modify the word βάθος (*bathos, depth*). According to this view Paul exclaims over the depth of God’s riches, the depth of his wisdom, and the depth of his knowledge. I think it is more likely, though one can hardly be certain, that the phrase βάθος πλούτου belongs together and that the words σοφίας and γνώσεως modify

βάθος πλούτου (cf. Murray 1965: 105–6). In this construction the first καί should be rendered “both,” and the “*depth of the riches, both of the wisdom and the knowledge of God*” are trumpeted. This latter interpretation should be favored because the phrase “*depth of the riches*” is an emphatic way to communicate the immeasurable extent of the ascribed qualities to God. The two words together convey the greatness of his **wisdom** and **knowledge**. To separate the word πλούτου (*riches*) so that it functions in a way similar to σοφίας (*wisdom*) and γνώσεως (*knowledge*) would mean that riches, wisdom, and knowledge are **parallel**. It is difficult to identify, however, what the word “*riches*” refers to in this scheme. Paul never uses the term to denote God’s saving riches without a defining genitive—unless one were to argue for such a construction here. The depth of God’s wisdom and knowledge is clearly set forth, but what does it mean to speak of the “*depth of God’s riches*”? What does “*riches*” refer to? It hardly seems parallel to the attributes of “*wisdom*” and “*knowledge*” that follow. But to speak of the “*depth of the riches, both of the wisdom and the knowledge of God*” is eminently clear. Paul extols the infinite wisdom and knowledge of God.

B. Inscrutable Judgments and Ways

“How unsearchable are His judgments and unfathomable His ways!”

Frank Thielman: God’s plan of reconciling the world to himself and, at the same time, of remaining faithful to his promises to Israel demonstrates that the power and intelligence of God are far beyond human comprehension.

Thomas Schreiner: Of course, human beings perceive the course of history and events as they occur. Paul would hardly deny that we see events as they take place. The point is that the mere observation of these events does not translate into an understanding of what God is doing in history. Human beings see the bare events as they transpire, but they do not perceive the saving plan of God that is being accomplished in and through these events. To us, the events of history may simply be “sound and fury, signifying nothing,” since on our own we are unable to perceive God’s wise plan for history. To perceive the meaning of the events in history, we need God’s interpretive binoculars, which will enable us to see aright what he is up to. The logic of the verse progresses from God’s wisdom and knowledge to his activity in the world. God’s wisdom is infinite and immeasurable, and this wisdom is expressed in the way he guides and superintends the history of the world. Here Paul is thinking not abstractly but concretely of God’s wisdom and activity with regard to Jews and gentiles. In his wisdom and knowledge he has planned history so that his judgments and ways would be effected in the lives of both Jews and gentiles. He has imprisoned all in disobedience to lavish his mercy on all.

Thomas Constable: God’s **wisdom** is His ability to arrange His plan so that it results in good for both Jews and Gentiles and His own glory. His **knowledge** testifies to His ability to construct such a plan—His divine ingenuity. His **decisions** (“*judgments*”) spring from logic that extends beyond human ability to comprehend. His **procedures** (“*ways*”) are so complex that humans cannot discover them without the aid of divine revelation (cf. **Isa. 55:8-9**).

Steven Lawson: “*How unsearchable are His judgments,*” let’s just look at these words. “*Unsearchable*” means that they are utterly incapable of being investigated to the full. We can only scratch the surface of this. And please look at the word “*unfathomable,*” “*how unsearchable*

are His judgments and unfathomable His ways!” This word “*fathomable*” means that cannot be traced out by man, and it comes from a Greek word that I think is worth bringing to our attention that is a Greek word for “footprint,” like you see someone walking on the beach and leaving footprints. And putting the prefix “un” in front of it means we can’t follow these footprints. They go over the horizon and out of view, and they’re **beyond our comprehension**. That’s the idea here.

C. (:34) **Inaccessible Mind of God**

“For who has known the mind of the Lord, or who became His counselor?”

Thomas Schreiner: The OT context of the citation is important. In **Isa. 40** the second exodus from Babylon is promised, but Israel is filled with doubts and fears because they are so weak and Babylon is so strong. Yahweh assures Israel that he can accomplish his saving plan because all the nations are as nothing before him, a mere drop in the bucket or a speck on his scales. The thematic connection to **Rom. 9–11** should not be missed. Just as Yahweh promised to save Israel when such deliverance seemed impossible and they had virtually given up, so too he has planned history in such a way that he fulfills the covenant promises made in Isaiah in an unexpected way. He has extended salvation to uncircumcised gentiles and at the end of history will again fold in unbelieving Jews. Does the inclusion of Israel again seem incredible? It is no more incredible than the pledge to rescue Israel from the dominion of Babylon. God effects salvation for the weak so that the glory of his strength is impressed upon all. Captive Israel in Babylon did not perceive the mind of the Lord, that it was his plan to rescue them from their plight; similarly no human being could anticipate the wisdom of God’s plan by which he has arranged history to bring about the salvation of both Jews and gentiles in a most improbable way. . .

No human being has the wisdom or knowledge to discern (much less to advise) God on the course that human history should take. His wisdom and plan are inaccessible to us. . . Nonetheless, in **Rom. 9–11** Paul has communicated the main strokes in that plan so that believers can discern the wisdom of God as it unfolds. This is not to say that comprehensive and exhaustive knowledge is granted to believers, only that the chief lineaments of his plan are made known to them. **Romans 11:34** is therefore remarkably similar in theme to **1 Cor. 2:16**: human beings cannot know God’s wisdom unaided, but they can access it as the Holy Spirit reveals it.

II. (:35) **PRAISING GOD’S AUTONOMY**

“Or who has first given to Him that it might be paid back to him again?”

Frank Thielman: The conclusion that Paul wishes his readers to draw from these rhetorical questions is similar to the point these questions made in the Scripture passages from which they come. **Hasty assessments of God’s injustice or unfaithfulness because of present circumstances are ill advised.** History has not yet fully traveled the course God has plotted for it, and he is powerful and wise enough to include even the present circumstances within his just and faithful purposes.

Thomas Schreiner: The meaning of the rhetorical question is not difficult: no one has first given to God; hence no one deserves repayment. This assertion is lodged in a context stressing that

God's wisdom and knowledge are inaccessible to humans. No one has access to the requisite wisdom to counsel God about the course of history; hence no one can expect a reward for their wise counsel. God and God alone has determined the course of history in his own wisdom, and we become aware of his plan only to the extent that he reveals it to us.

Grant Osborne: Paul quoted loosely from **Job 41:11** to point out that God is in sovereign control. He is not in our debt, we are in his!

The implication of this series of questions is that no one has fully understood the mind of the Lord. No one has been his advisor. And God owes nothing to any one of us. Isaiah and Jeremiah asked similar questions to show that we are unable to give advice to God or criticize his ways (**Isaiah 40:13; Jeremiah 23:18**). God alone is the possessor of absolute power and wisdom.

Charles Hodge: This is not to be confined to giving counsel or knowledge to God, but expresses the general idea that the creature can do nothing to place God under obligation. It will be at once perceived how appropriate is this thought, in reference to the doctrines which Paul had been teaching. Men are justified, not on the ground of their own merit, but of the merit of Christ; they are sanctified, not by the power of their own good purposes, and the strength of their own will, but by the Spirit of God; they are chosen and called to eternal life, not on the ground of anything in them, but according to the purpose of him who worketh all things after the counsel of his own will. God, therefore, is the Alpha and the Omega of salvation. The creature has neither merit nor power. His hopes must rest on sovereign mercy alone.

Steven Lawson: This question deals with **salvation**. Who has given to God anything by which God would be now a debtor or a creditor to this person to give back to him? Who has earned any gift from God? To whom does God owe salvation? Now, there is a sense in which God owes justice, but He does not owe grace. That is a very important question and it is an important question at every level of salvation. To whom does God owe His sovereign election? What has anyone ever done that would cause God to choose them in eternity past? What has anyone ever done that would cause God to foreknow them, to choose to love them? What merit was there or is there in any person that would elicit the foreknowledge of God? What has anyone ever done that would cause God to call them to Himself? What has anyone ever done that would cause God to grant to them saving faith? What has anyone done that would cause God to justify them freely? What has anyone done that would cause God to glorify them one day in heaven? That is the question that is raised. . .

So, as we bring this to conclusion, let me just give you three words by way of application. The first is "honor." What honor and worship and praise we should give to this God who is so transcendent and so majestic and so beyond any one of us, beyond what we can even comprehend? We know but the outer fringes of who He is. Let us bow down before this God and give Him the honor that belongs to Him alone, which leads second to "humility." As we would rise up to bless Him, we do so best when we bow down before Him. Let us lower ourselves before this God who is **self-ruling** and **self-governing** and recognize our proper place. It is a place that Job had to be brought to. And I pray that God would not have to humble me or humble you as He did with Job, that we would of our own recognition realize who He is and who we are

and humble ourselves. He holds our entire life in His hands. And the last word is “hunger.” Let us hunger to know more of this God.

III. (:36a) PRAISING GOD’S ULTIMATE SOVEREIGNTY AND CONTROL

A. Source -- Everything Originates from God -- Creator

“For from Him”

James Dunn: In an argument which began with man’s rebellion against God as creator (**1:18–25**), what could be more appropriate than a final acclamation of God the creator? In the final analysis the election of Israel, the gospel outreach to the Gentiles, the whole course of salvation-history itself, are simply aspects of the most fundamental relation of all, that of the Creator with his creation. *To him alone be the glory forever. Amen.*

B. Means -- Everything Operates through God’s Agency -- Sustainer

“and through Him”

C. Goal -- Everything Works Together to Accomplish God’s Purposes - Omega

“and to Him are all things.”

(:36b) ALL FOR THE GLORY OF GOD

“To Him be the glory forever. Amen.”

Steven Lawson: What is the glory due God? Come back to our text in **Romans 11:36**, “*To Him be the glory.*” Do you see that word, “*glory*”? It is the Greek word *doxa* from which we derive the English word “*doxology*.” It is a twofold. I can hear **R.C. Sproul** in my ear right now, not literally, but by memory telling me, “Steve, theologians have to make careful distinctions.” So, here I want to make a distinction between the two ways “*glory*” is used in the Bible. One is God’s **intrinsic glory**; the second is His **ascribed glory**.

So first, His **intrinsic glory**. That is, “*glory*” is used as the sum and the substance of all that God is. It is the composite of all of the attributes of God: His holiness, His sovereignty, His righteousness, His love, His grace, His mercy, His truth, etc. All of that is the intrinsic glory of God. You cannot give intrinsic glory to God. God is who God is. He is the God who was, who is, who shall be forever. “*From everlasting to everlasting, You are God.*” God is never increasing in His intrinsic glory, He is never decreasing in His intrinsic glory. He is immutable throughout all the ages in His intrinsic glory. So, we cannot give intrinsic glory to God. God is who God is.

So, this leads us to the second use of “*glory*” in the Bible, and that is “**ascribed glory**,” and that is how it is used here. Ascribed glory is the glory that we give to God, and in that sense ascribed glory is the praise and the worship that we give to God. That’s how it is used here, “*To Him be the glory.*” Ascribed glory belongs to God the Father. He is a jealous God and will not share His glory with another. Ascribed glory is how it is used. Let me give you three quick cross - references:

- **Ephesians 3:21**, “*To Him be the glory.*”
- **1 Timothy 1:17**, “*Now to the King eternal, immortal, invisible, the only God, be honor and glory forever and ever. Amen.*” Sounds much like **Romans 11:36**.

And let me tell you how this works. The more you perceive and understand God’s intrinsic glory, the more you will ascribe glory to God. In other words, the more you grow in the knowledge of God’s intrinsic glory, who He is, the more ascribed glory you will give to Him. That is why the preacher who expositors the Word of God is in reality the primary worship leader in any church. The music leader is just that. He is the music leader and hopefully what is being sung will be sound doctrine and theology, but he is only a secondary worship leader. The primary worship leader is the man who opens this book and gives a fuller knowledge of who God is. So, that is why understanding the intrinsic glory of God is so important.

- Let me give you one more cross-reference though, just to round this out, in **Revelation 4 and verse 11**. This is crystal clear. I hope it is becoming clearer to you. **Revelation 4:11**. The scene around the throne and the redeemed saints and the angelic hosts are saying this to the Lord, God the Father, “*Worthy are You, our Lord and our God, to receive glory and honor and power.*” This glory is the ascribed glory that we are to give to God. Here it is synonymous with giving honor to God. The word “*power*” here is a part of His intrinsic glory. They are not giving power to God; they are **recognizing the power** that He has, and in so doing that causes their heart to be ignited with greater worship to give glory and honor to God.

* * * * *

DEVOTIONAL QUESTIONS:

- 1) How can you incorporate this attitude of adoration to guard against questioning or accusing God?
- 2) What is the difference between God’s perspective and your perspective in a given situation?
- 3) When are you tempted to try to manipulate or control God rather than submit to His inscrutable wisdom and purposes?
- 4) How can you orient your ambition and passion in life to promote the glory of God?

* * * * *

QUOTES FOR REFLECTION:

Vine: Chiastic structure of this doxology:

- A Oh, the depth
- B of the riches
- C both of the wisdom
- D and knowledge of God!
- E How unsearchable are His judgments
- E' and unfathomable His ways!
- D' For who has known the mind of the LORD?
- C' or who became His counselor?
- B' Or who has first given to Him, that it should be paid back to him?
- A' For from Him, and through Him, and to Him are all things. To Him be the glory forever.

Steven Cole: The main idea that comes through in our text is **the immensity of God and the relative puniness of man**. **Charles Hodge** puts it (*Commentary on the Epistle to the Romans* [Eerdmans], p. 377), “Few passages, even in the Scriptures, are to be compared with this, in the force with which it presents the idea that God is all, and man is nothing.” **Isaiah 40**, from which Paul cites (v. 34), may compare. In that great chapter, Isaiah says (**40:15, 17**), “*Behold, the nations are like a drop from a bucket, and are regarded as a speck of dust on the scales, ... All the nations are as nothing before Him, they are regarded by Him as less than nothing and meaningless.*”

Paul also cites from Job (**41:11**), where for four chapters God grills Job on where he was when God created the heavens and the earth and all that is in it. God relentlessly hammers home the truth that He alone is great and no man, not even the most righteous man on the face of the earth, is great. At the end, Job answers (**42:2**), “*I know that You can do all things, and that no purpose of Yours can be thwarted.*” He goes on to admit that he had declared things beyond his knowledge and understanding, and so he repents in dust and ashes. It is that same exalting of God and humbling of us that Paul sets forth here. His message is:

Since God is far greater than you can comprehend and you are not great, humble yourself before God and worship Him.

Bob Deffinbaugh: There is only one response appropriate to what Paul has taught us in chapters 9-11. It is not accusation, but acclamation. We cannot, we dare not, challenge the sovereignty of God. We must bow before it. The sovereignty of God is neatly summed up for us in verse 36: “For from Him and through Him and to Him are all things. To Him be the glory, forever. Amen.” God is the source of all things. All things originate from His eternal decree. God is the efficient cause of all things. He is the One Who brings His will to pass. God is the goal of all things. He is the One for Whose benefit all things take place. We, like all creation, are here for God’s glory.

Our response to the sovereignty of God as expressed in history through the partial and temporary rejection of Israel and the salvation of Gentiles should be one of wonder and praise at the wisdom of the One Who has willed it so. Further, it should impress upon us our incapability and

inadequacy to challenge the working and the will of God in the affairs of men. Could we ever advise a God like ours? Does He need our counsel or our approval? Let us bow, with Paul, in speechless praise, to the sovereign God Who does all things well.

Steven Lawson: When Paul says “*the wisdom of God*” here, he’s talking about the infinite genius of God that is contained in the **gospel of Jesus Christ**. The brilliance of God to design the gospel in order to rescue unworthy, perishing sinners from eternal punishment. This wisdom of God is contained in the gospel of Jesus Christ. And just think of this vast wisdom of God just in the virgin birth, in the hypostatic union of Christ, that He was truly God and truly man. Who but God could have thought of this? In the active obedience of Christ to keep the law of God on our behalf, we who were lawbreakers, who but God in His wisdom could have designed this?

Think of the cross, think of the substitutionary death of Jesus Christ upon the cross. There you see the wisdom of God. None of us would have ever dreamed up the cross of the Lord Jesus Christ, that all of our sins would be transferred to the innocent Lamb of God. We would have never thought of this, but God did in His wisdom that He reconciled holy God to sinful man through the blood of the cross, there’s the wisdom of God. And that He would be taken down from the cross, buried, raised on the third day, ascended to the right hand of God the Father. Only the wisdom of God could have designed this. It would have never entered our minds, not in a million years.

I want to take us to **1 Corinthians 2** just for a moment, because this will shed even greater light and insight. Because the epitome of this wisdom is found in Christ and in Him crucified. And so in 1 Corinthians **chapter 2**, beginning in **verse 7**, he says, “*We speak God’s wisdom in a mystery,*” and this wisdom he laid out at the end of **chapter 1**, which is very simply “*Christ and Him crucified.*” In fact, he said in **chapter 2 verse 2**, “*For I determined to know nothing among you except Jesus Christ and Him crucified.*” There is the wisdom of God.

If you would turn back to **chapter 1** and **verse 18**, “*For the word of the cross is foolishness to those who are perishing, but to us who are being saved, it is the power of God.*” What is the wisdom of God in Christ and Him crucified is utter foolishness to the carnal mind. And to the unconverted, darkened mind, when they hear the message of the cross it is foolishness. But for us who have now the mind of Christ, it is the jaw-dropping brilliance of God that we can be reconciled to God through the blood of the cross.

If you will, look at **verse 21** of **1 Corinthians 1**, “*For since in the wisdom of God the world through its wisdom did not come to know God, God was well-pleased through the foolishness of the message preached,*” and Paul uses foolishness there in a sarcastic way. It’s foolishness to the world but in reality, it’s the sheer genius and wisdom of God in the cross to save those who believe.

He says in **verse 23**, “*We preach Christ crucified, to Jews a stumbling block, and to Gentiles foolishness.*” **Verse 24**, “*But to those who are called, both Jews and Greeks, Christ the power of God and the wisdom of God.*” This is the wisdom of God in the power of the cross of the Lord Jesus Christ.

Well, come back now to **chapter 2, 1 Corinthians 2**, and **verse 7**, “*We speak God’s wisdom in a mystery, the hidden wisdom which God predestined before the ages to our glory,*” really meaning “*to our good.*” **Verse 8**, “*The wisdom which none of the rulers of this age has understood. For if it had understood it, they would not have crucified the Lord of glory.*” Let’s just pause there for a moment. Even in the wisdom of God, He kept the rulers of the Roman Empire and the nation Israel in darkness so that Christ would be crucified, even that was the wisdom of God.

Now, **verse 9** is what I really want us to see. “*But just as it is written,*” and **verse 9** is quoting **Isaiah 66 verse 4**, and **Isaiah 65 verse 17**, it’s a verse you’re very familiar with but you’ve probably not seen it in context. “*Things which eye has not seen and ear has not heard, and which has not entered the heart of man. All that God has prepared for those who love Him.*” We normally hear this read at a funeral, and normally hear it referred to as what is awaiting us in heaven. That’s not in the context, that’s not in the passage. What this is talking about is the **wisdom of God in the gospel of Christ crucified**. Eye has not seen and ear has not heard, and it has never entered into the heart of man this wisdom of God to save sinners by the blood of the cross. So what **verse 9** is telling us is the inscrutable wisdom of God has designed the cross, and it would have never dawned on us that this would be the plan of salvation.

So as Paul is in **Romans 11:33** and he says, “*Oh, the depth of the wisdom,*” this is what he’s talking about, the wisdom of Christ and Him crucified, the wisdom that God can be both just and the justifier, that God can save sinners yet in no way forfeit His righteousness by failing to punish sin. He has punished our sin in the person of His Son, the Lord Jesus Christ.

Warren Wiersbe: Having contemplated God’s great plan of salvation for Jews and Gentiles, all Paul could do was sing a hymn of praise. As someone has remarked, “**Theology becomes doxology!**” Only a God as wise as our God could take the fall of Israel and turn it into salvation for the world! His plans will not be aborted, nor will His purposes lack fulfillment. No human being can fully know the mind of the Lord, and the more we study His ways, the more we offer Him praise. Are we to conclude that God does *not* know what He is doing, and that the nation of Israel completely ruined His plans? Of course not! God is too wise to make plans that will not be fulfilled. Israel did not allow Him to rule, so He overruled!

John Murray: The theme of **verses 33, 34** may be stated as the **incomprehensibility of God’s counsel**. The terms “*unsearchable*” and “*past tracing out*” indicate this. It is a mistake, however, to think that God’s incomprehensibility applies only to his secret, unrevealed counsel. What God has not revealed does not come within the compass of our knowledge; it is inapprehensible. What is not apprehended is also incomprehensible. But the most significant aspect of incomprehensibility is that it applies to **what God has revealed**. It is this truth that is conspicuous in this passage. What constrains the doxology is the **revealed counsel**, particularly that of **verse 32**. The apostle is overwhelmed with the unfathomable depth of the scheme of salvation which has been the subject of discourse in the preceding context. Besides, the riches and the wisdom and the knowledge of God which he views as a great deep are not unrevealed. They are the riches of grace and mercy, the deep things of God revealed by the Spirit, and the wisdom not of this world disclosed to the saints (cf. **I Cor. 1:24; 2:6-8**). Furthermore, the judgments that are unsearchable and the ways past tracing out are those of which the apostle had given examples

Leedy Greek NT Diagrams:

Rom 11:33

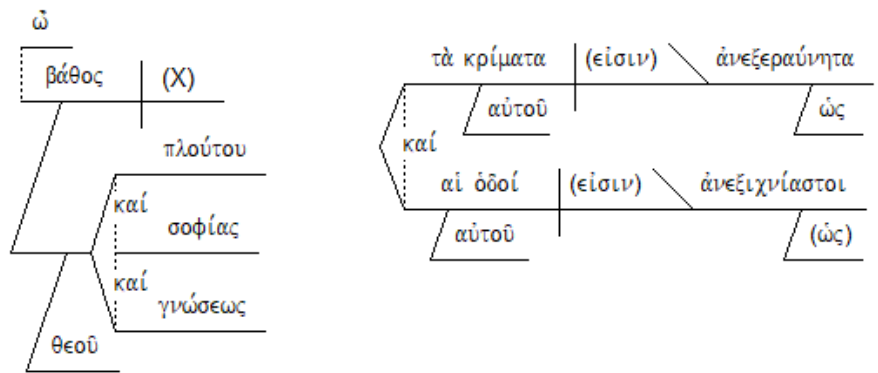

Rom 11:34

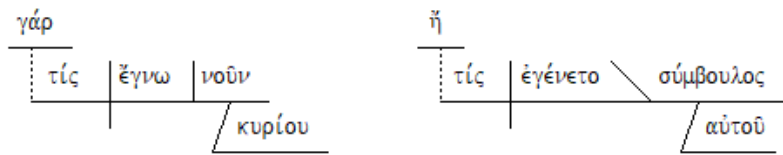

Rom 11:35

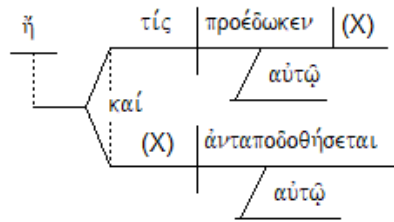

Rom 11:36

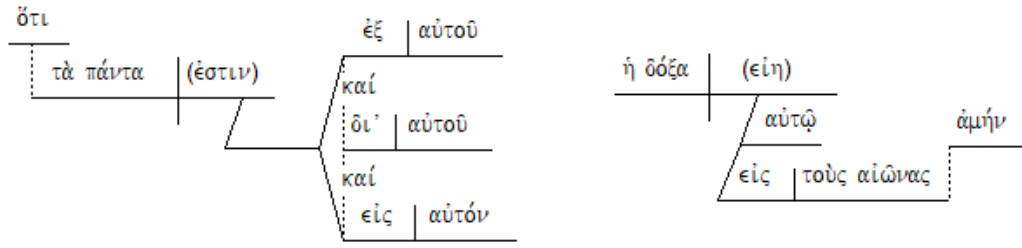

Frank Thielman:

- 33a Exclamation **How deep is the wealth and wisdom and knowledge of God!**
- b Exclamation **How undiscoverable his judgments and untraceable his ways!**
- 34a Rhetorical Question For, "Who has known the mind of the Lord?"
- b Rhetorical Question Or who has become his adviser?" (Isa 40:13)
- 35 Rhetorical Question Or "who has advanced him a sum and will be repaid by him?" (Job 41:11)
- 36a Basis (for 35) Because **all things are from him and through him and for him.**
- b Agency
- c Advantage
- d Exclamation **Glory belongs to him** as age gives way to age.
- e Conclusion **Amen.**

TEXT: ROMANS 12:1-8

TITLE: DEDICATED SERVICE IN UNITY THROUGH DIVERSITY

BIG IDEA:

WE ARE CALLED TO SERVE GOD THROUGH SERVING IN HIS BODY

INTRODUCTION:

Frank Thielman: Paul exhorts his readers to make decisions about their day-to-day conduct on the basis of God's transformation of their minds through the gospel (**Rom 12:1–2**). They should carry out their roles within the community of believers (**12:3–8, 10, 13a, 16**) and among their unbelieving neighbors (**12:9, 11–12, 13b, 14–15, 17–21**) with a humility and love that reflects God's sincere and unconditional love for them. They should not respond to the marginalization they are experiencing within their society with an attitude of revenge seeking and rebellion. Rather, they should respond with love, recognizing that God is in control of events around them even when his ways are difficult to discern. One day his justice would obviously prevail. In the way they handle social tensions within their own believing community, they should work for peace and they should build up one another, accepting one another as Christ accepted them (**14:1–15:13**). . .

Main Idea: Through the gospel God has mercifully transformed believers from enemies in rebellion against him into sons and daughters at peace with him. In light of this transformation, the thinking and behavior of God's people stands in stark contrast to the world in which they live their day-to-day lives. Each member of the believing community now pursues whatever role God has given him or her with humility and enthusiasm. This humble service to others is one of the primary ways in which believers stand apart from the larger unbelieving society in which they live.

John MacArthur: Most Christians never really come to that place fully. They flirt with the world, they flirt with the flesh. They flirt with their own personal indulgences and desires. They become victims of the philosophy and psychology of the world around them. They buy into the world's bag. They entertain themselves with the world's mode of entertainment. They think along the lines the world thinks. And so they never really come to the place of total commitment that is discussed in these two verses and therefore they forfeit the fullness of the blessing that God would have for them. . .

First of all, we offer ourselves in the single supreme act of worship that any believer can do as a living sacrifice, offering to the Lord **our whole soul, body, mind and will**, as we discussed in our look at **verses 1 and 2**. Now this is the basic requirement that God lays down for every believer. It's no different for you than it is for me. We're all in the same place when it comes to **Romans 12:1 and 2**. God wants our life, as they sang so beautifully a moment ago, offered as a living sacrifice, holy, acceptable unto Him, which is the basic act of spiritual worship. That is the **entrance into usefulness**. That's where we begin to be used by God. It is worship, the offering of ourselves, then it is service. That's the divine order.

Now when it comes to this service, as we read in the text from **verses 3** through **5**, we want to recognize that **though there is unity at the level of commitment, there is tremendous diversity at the level of service**. And **verse 4** and **5** emphasizes that. Like a body that has many members, so the body of Christ has many members, and **verse 6**, they have **differing gifts**. We all stand on the same common ground in the unity of commitment. But from there on out there is tremendous diversity, tremendous diversity. We are as diverse in terms of our service as we are diverse in terms of our own personal identity. There are no two Christians alike. There are no two of us who can serve the Lord alike. There's tremendous distinction and distinctiveness in all of us.

I. (:1-2) SERVING GOD – OFFERING OURSELVES AS LIVING SACRIFICES PLEASURES GOD AND ENABLE US TO EXPERIENCE HIS PERFECT WILL

Paul Fink [*Grace Seminary Notes*]: Beginning with **Romans 12:1-2**, Paul begins a new division of his epistle, **Application (12:1 – 15:13)** in which he will show how the righteousness of God is to be worked out in the daily lives of those who possess the righteousness of God. At this point Paul moves from the doctrinal portion of the book (**chapters 1-11**) to the practical portion (**chapters 12-16**). In **Romans 12:1-2** Paul sets forth the basic principle of God's righteousness at work in the believer's life; then he will turn (**12:3 – 15:13**) to show specific applications of God's righteousness at work in the believer's life. He will show how the righteousness of God should work in the believer's life in relationship to:

1. The local church, **12:3-21**;
2. The state, **13:1-14**;
3. and doubtful things (**14:1 – 15:13**).

Thus, **Romans 12:1-2** can be understood as introducing each of these sections and rightfully should be read as an introduction to each of them.

Douglas Moo: **Romans 12:1–2** is one of the best-known passages in the Bible—and deservedly so, for we find here a succinct description of the essence of the **believer's response to God's grace in the gospel of Jesus Christ**. It functions as the heading for all the specifics Paul will unpack in the subsequent chapters. Our response is rooted in God's grace. The NIV's "*God's mercy*" conceals the fact that the Greek word for "*mercy*" is in the plural ("*mercies*"). Paul is reminding us of the many displays of God's mercy he has touched on in **chapters 1–11**. "*In view of*" probably modifies "*urge*"; Paul exhorts us in light of the manifold mercy of God. Our obedience is the product of what God has done in our lives, not something we can manufacture on our own.

R. Kent Hughes: Elements of Commitment

- The Basis of Commitment (**v. 1a**)
- The Character of Commitment (**v. 1b**)
- The Demands of Commitment (**v. 2a**)
- The Effects of Commitment (**v. 2b**)

A. (:1a) Our Motivation to Serve God

“I urge you therefore, brethren, by the mercies of God,”

McClain: There are three *therefores* in Romans and they mark the three great divisions in the book.

Calvin: An inference from the entire didactic section preceding. . . Paul here lays down the principle from which all the parts of holiness flow – we are redeemed by the Lord which leads to our consecration.

Everett Harrison: Whereas the heathen are prone to sacrifice in order to obtain mercy, biblical faith teaches that the divine mercy provides the basis for sacrifice as the fitting response.

B. (:1b) Our Dedication to Serve God – Characterized by:

1. Commitment

“to present your bodies”

Thomas Schreiner: The aorist form of the infinitive is occasionally adduced to support the idea that total commitment to God is a definitive once-for-all act that should never be repeated, or is the process by which one attains entire sanctification (see the helpful article by **Maddox** 1981; cf. **D. C. Peterson** 1993: 281). This is a **misreading of the aorist tense**, which does not inherently denote once-for-all action. Surprisingly, **Jewett** (2007: 728–29) continues to promote such a reading. Whether the aorist signifies an action that occurs only once is indicated by other contextual factors (see **Stagg** 1972). No such contextual factors are present here. In **verse 2** the two imperatives, συσχηματίζεσθε (*syschēmatizesthe, be conformed*) and μεταμορφοῦσθε (*metamorphousthe, be transformed*), are both **present tense**, which cautions against undue emphasis on the aorist tense in **verse 1**. . .

the word “*bodies*” here refers to the **whole person** and stresses that consecration to God involves the whole person. One cannot consign dedication to God to the spirit and neglect the body. Genuine commitment to God **embraces every area of life** and includes the body in all of its particularity and concreteness.

Steven Cole: “*Present*” is in the aorist tense, which leads some to emphasize that this is a once and for all decision. But that is a simplistic understanding of the Greek aorist tense, which focuses on an action as a whole, not necessarily as a point in time. Besides, as some wag has pointed out, **living sacrifices have a way of crawling off the altar**. So you’ve got to keep **renewing this commitment**. You present all of yourself that you’re aware of to all of God that you know. But as you grow in the Christian life, you become aware of areas in your life that are not yielded to God. So you put those things on the altar. You become aware of more about the lordship of Christ than you knew. So you yield again and again to Him. So there is a first time when you present your entire life to the Lord to do whatever He wants you to do. But it’s also progressive as you grow to understand more about yourself and God.

2. Consecration

“a living and holy sacrifice,”

R. Kent Hughes: The **totality of the commitment** comes dramatically to us through the **language of sacrifice**. The Greek translated “*to present*” is a technical term used for the ritual presentation of a sacrifice. “*Your bodies*,” referring to more than skin and bones, signifies everything we are—**our totality**. “*Sacrifice*” refers to the holocaust in which the offering is totally consumed. Old Testament sacrifices pervade the picture—total sacrifice. Moreover, this sacrifice is described as “*living . . . holy . . . acceptable*.” The believer isn’t killed as the Old Testament sacrifices were, but remains alive. We are to be living sacrifices in the deep theological sense of “*newness of life*” (cf. **6:4**). We are also to be “*holy*” in that we have renounced sin and are set apart to God. Finally, we are to be “*acceptable*” sacrifices not because we deserve to be accepted, but because the offerings are **true to God’s specifications**.

Douglas Moo: Paul probably wants us simply to contrast ourselves with the dead animal sacrifices of the Old Testament (see also **John 6:51**). But God demands sacrifices that are “*holy*,” that is, apart from profane matters and dedicated to his service.

Michael Bird: This sacrifice is described by three adjectives that should not be separated: “*living*,” “*holy*,” and “*pleasing*.” First, a “*living sacrifice*” is one that does not die by bloodletting, it is not burned up or consumed like regular sacrificial offerings, but its life continues to endure. So believers are living sacrifices in the specific sense that they have been crucified with Christ (**6:6**) and live as slaves of righteousness leading to holiness (**6:19**).

Second, “*holy*” denotes something set apart and dedicated to God as opposed to something common or profane. The Roman believers are “*called holy*” (**1:7**) because of the Holy Spirit “*given*” to them (**5:5**), who has “*sanctified*” them (**15:16**), and who empowers them for righteousness, joy, hope, peace (**14:17; 15:13**).

Third, “*pleasing to God*” expresses the result of sacrifices that are “*living*” and “*holy*,” in that they receive divine favor (see **Phil 4:18**). A good commentary on this language occurs in **Romans 15:16**, where Paul describes the goal of his apostolic ministry as to make the Gentiles “*become an offering acceptable to God, sanctified by the Holy Spirit*.” Put in that light, **Sarah Whittle** is correct that “this is more than a contextualising of Greco-Roman sacrifice or a ‘replacement’ for Israel’s cult. Rather, this is fulfilment language, and these cultic motifs from Israel’s Scripture help Paul to develop the role and status of the Gentiles in Israel’s salvation history.”

3. Cherished “*acceptable to God*,”

The Lord desires spiritual sacrifices that are **valuable in His eyes**.

Definition of Sacrifice = to suffer the loss of something; give something up; a surrender of something for the sake of something else; offering to God something precious

- Examples of Worthless Sacrifices = have no value in the eyes of the Lord; based on human initiative

- Cain failed in this area (**Gen. 4:3-8**); contrast **Heb. 11:4**
 - Adab and Abihu, sons of Aaron, offered strange fire and were judged (**Num. 3:4**)
 - **Prov. 15:8**
 - Empty ritual without heartfelt repentance and obedience (**Psalm 51:16-17**; **Prov. 21:3**);
 - Annas and Sapphira (Acts 5)
- Characteristics of Worthy Sacrifices
- Must be associated with obedience and faith in God’s Word rather than rebellion and rejection of God’s Word
 - **1 Sam. 15:22-23**
 - Attitude of reverence and fear of the Lord; not flippant or overly casual
 - Must be sincere and from the heart; not hypocritical (**Isa. 29:13**)
 - Must be purposeful and voluntary and cheerful – not out of sense of grudging obligation (**2 Cor. 9:7**)
 - Must be designed to please God rather than to impress men (**Matt. 6:1**)
 - Must be from a motivation of Thanks giving rather than trying to earn God’s favor (**Psalm 50:14, 23**; **Heb. 13:15**)
- Evaluating how Precious and Costly and Difficult and Heroic is the sacrifice
- **Gen. 22:2**
 - **John 3:16**
 - **1 Pet. 1:18-19**
 - **Deut. 15:21**
 - **Matt. 26:6-13**
 - **Mark 12:41-44**
 - **2 Sam. 23:13-17**
 - **Phil. 2:17**

4. Consistency with a Proper Understanding of How to Worship God
“which is your spiritual service of worship.”

Frank Thielman: This is “*reasonable worship*” because it makes sense—it matches God’s own merciful character as it is displayed in the good news that God has redeemed his people from slavery to sin.

Thomas Schreiner: All that needs to be said is that Paul used the term with the meaning “*rational*” or “*reasonable*,” as was common in the Greek language. His purpose in doing so was to emphasize that yielding one’s whole self to God is **eminently reasonable**. Since God has been so merciful, failure to dedicate one’s life to him is the height of folly and irrationality.

Douglas Moo: But when the background is considered, we think “*informed*” or “*understanding*” is the best single equivalent in English. We give ourselves to God as his sacrifices when we understand his grace and its place in our lives. We offer ourselves **not ignorantly, like animals brought to slaughter**, but intelligently and willingly. This is the worship that pleases God. . .

I am afraid that what passes for worship in some churches goes little beyond an **emotional reaction** to a certain form of music. Some writers of music and certain kinds of worship leaders know how to get people excited, but I am not always clear that they are getting people to worship. Emotions must, of course, play a role in worship. But it is both easy and tempting to focus too much on an emotional reaction to music, bypassing the mind entirely. Yet if I read **Romans 12:1** rightly, this is not the kind of worship that truly pleases God. Worship that pleases him and that truly leaves its mark on a believer **always engages the mind**.

C. (:2a) Our Transformation to Serve God

1. Avoid Conformation to This World

“And do not be conformed to this world,”

R. Kent Hughes: The painful truth is, such conformity is common to many of us to a greater extent than we like to acknowledge. Sometimes it is difficult to know when we are conforming because there are many good things in the world. Moreover, we are not to write off our culture entirely. Yet we must think critically. As **Harry Blamires** says in *The Christian Mind*: “Because secularism is in the saddle, it follows that the Christian mind is suspicious of fashionable current conformities.”

We must be careful what we read and watch. We must not fear to challenge others’ presuppositions. Above all, we must not be afraid to be different.

2. Pursue Mind Renewal Leading to Transformation

“but be transformed by the renewing of your mind,”

Frank Thielman: The **transformation** Paul describes happens through a renewal of the way believers think about the world. This is the reverse of the process Paul had outlined in **Romans 1:28** where human beings did not “*deem it worthwhile*” (ἐδοκίμασαν) to acknowledge God, and so God “*handed them over to a worthless mind* [ἀδόκιμον νοῦν].” A “*worthless mind*” is a mind unaffected by the transforming Spirit of God, a mind that may be able to acknowledge the goodness of God’s law (**7:12, 16**; cf. **1:32**), but is unable to obey it because the flesh overpowers its will to do good (**7:18–25**). Now, however, the renewal of the mind results in believers “*approving*” (δοκιμάζειν) the will of God so that they are actually able to present their bodies as living sacrifices to God and couple the approval of God’s will with obedience. Paul does not mention the Spirit of God here, but he has already explained that this movement from acknowledging the good to actually doing it comes to believers through the transforming work of the Spirit (**8:2–9, 12–13**).

R. Kent Hughes: The language is graphic. “*Transformed*” sounds like “*metamorphosed*” in the original and is the word from which we get metamorphosis, the change from one form to another, as in the transformation of the tadpole to the frog or the caterpillar to the butterfly. But the full meaning is even richer, as the other three uses of the word in the New Testament indicate. In **Matthew 17:2** and **Mark 9:2** it is used to describe the transfiguration of Christ—when the Lord’s glorious inner essence was allowed to show through his body so that his face radiated like the sun and his clothing was white with light. We experience such transfiguration in Christ. As Paul says in **2 Corinthians 3:18** (using the very same word):

And we all, with unveiled face, beholding the glory of the Lord, are being transformed into the same image from one degree of glory to another. For this comes from the Lord who is the Spirit.

How does this happen? Again the language in Romans is most expressive, because our text says we are to “*be transformed*” (**passive imperative**). This must be done by someone or something else, which is of course the **Holy Spirit**. We are to submit to the Holy Spirit who brings about “*the renewal of your mind.*” We also understand from the **present tense** of the verb that this is a **process**, a gradual transformation. The Christian is to allow himself to be changed continually so that his life conforms more and more to that of Christ. Ultimately, as **Romans 8:29** says, there will be the supreme metamorphosis when we will be transformed (*summorphos*) to the image of Christ in eternity.

Steven Cole: God does not change our **basic personality type**; rather He changes the sinful manifestations of our personality. Before he was converted, Paul was a hard-driving, everything-for-the-cause man. After he was saved, he was all out for the Lord. But he mellowed and became more gracious as he grew in the Lord. When Mark abandoned Paul and Barnabas on the first missionary journey, Paul wouldn’t consider giving him a second try. He and Barnabas had a fierce conflict and parted ways over the matter. But later in life, Paul told Timothy (**2 Tim. 4:11**), “*Pick up Mark and bring him with you, for he is useful to me for service.*” God will use your personality, but He will **sandpaper off your rough edges**. Study the weaknesses that you are prone to, so that you can be on guard against them and work to overcome them.

D. (:2b) Our Goal to Serve God

1. Ability to Discern God’s Will

“that you may prove what the will of God is,”

2. Approval of What God Desires

“that which is good and acceptable and perfect.”

John Toews: The reason for this active engagement in intellectual transformation is in order that you may test what is the will of God, the good, well-pleasing, and complete. The word for *test* means to determine what is valid or genuine, to distinguish the authentic from the sham. Non-transformed Christians cannot discern or test the direction God wishes. The capacity for Christians to test or discern appropriate mental and moral judgment and action depends on not conforming but being transformed through the renewal of the mind. The will of God is defined as that which is *good* (what is intellectually and morally consistent with the righteousness of God), the *well-pleasing* (what is acceptable to God), and *complete* (what moves toward wholeness).

Kenneth Wuest translation: And stop assuming an outward expression that does not come from within you and is not representative of what you are in your inner being, but is patterned after this age; but change your outward expression to one that comes from within and is representative of your inner being, by the renewing of your mind, resulting in your putting to the test what is

the will of God, the good and well-pleasing, and complete will, and having found that it meets specification, placing your approval upon it.

II. (:3-8) THROUGH SERVING IN HIS BODY – AS MEMBERS OF THE SAME BODY WE ARE CALLED TO SERVE WHOLEHEARTEDLY IN OUR GIFTED ROLE

Thomas Schreiner: The structure of **verses 3–8** itself is not too difficult to delineate. Paul begins with an exhortation not to succumb to pride when estimating oneself, warning them to think soberly and in accord with the measure of faith that has been apportioned to each person (**v. 3**). **Verses 4–5** function as the basis (γάρα) for the exhortation in **verse 3**. The differences evident in the people of God are part of God’s design and are analogous to the unity and diversity of the human body. A human body could not function unless it were marked by diversity. Similarly, the disparate functions in the body of Christ do not threaten its unity but are essential to its very nature as a body. The third section of the text, **verses 6–8**, itemizes seven different gifts. The number seven does not symbolically represent completeness, nor are the full complement of gifts listed (cf. **1 Cor. 12:8–10, 28–30**). Seven representative and vital gifts are named, but the emphasis falls on **the manner in which the gifts should be exercised** or the necessity to devote oneself to the gift that God has granted to one. When we examine these verses as a whole, it seems that the exercise of gifts should not be separated from the unity of the body. By **emphasizing unity**, Paul anticipates **chapters 14 and 15**, particularly the closing exhortation to both Jews and Gentiles in **15:7–13** (so **Smiga** 1991: 268–69).

James Dunn: Significantly, the first example Paul gives of living by immediacy of divinely given discernment is the mutuality of charismatic ministry within the body of Christ, the eschatological equivalent to the cultic assembly of Israel.

A. (:3) Transformed Thinking about Ourselves – To Properly Balance Humility and Faith

1. Perspective of Humility

a. Stated Negatively

“For through the grace given to me I say to every man among you not to think more highly of himself than he ought to think;”

Thomas Schreiner: Paul’s unique **apostolic role** and authority are a constant theme in his letters (e.g., **Rom. 15:15–16; 1 Cor. 3:10; 15:9–10; Gal. 2:9; Eph. 3:2, 7–8; 1 Tim. 1:12**). Here this theme has twofold significance.

- First, he is not merely passing along good advice or his personal opinions. The following exhortations derive from an **authoritative apostolic messenger**.
- Second, in subsequent verses Paul **warns the Romans against pride** and exhorts them to use their gifts appropriately. If anyone would be liable to pride, those designated as apostles would be prime candidates. Yet Paul is keenly aware that his apostolic office is a gift of grace and cannot be attributed to his own accomplishments.

By this point in Paul’s career, his faithfulness in fulfilling his apostolic calling was well known. In both respects, therefore, **Paul models the exhortations that follow**.

Griffith Thomas: Humility is the direct effect of consecration, because pride is, and ever has been, the great enemy of true righteousness.

b. Stated Positively

“but to think so as to have sound judgment,”

2. Perspective of Faith

“as God has allotted to each a measure of faith.”

Frank Thielman: The transformed minds of believers should produce in them a humility based on the knowledge that faith, and all that goes with it, are gifts of God. The faith God has given to each believer is sufficient to sustain that believer’s role in the community, and believers need to think clearly and realistically about their particular role.

Thomas Schreiner: I conclude, then, that Paul is speaking of the **quantity of faith** or trust that each believer possesses. Elsewhere Paul acknowledges that believers have different levels of faith (**Rom. 14:1**), and thus one cannot dismiss this idea as anti-Pauline. **Cranfield** objects that this interpretation would lead to the very pride warned against, since believers with a greater quantity of faith would surely feel superior to those having a lesser amount. Contrary to **Cranfield**, Paul does not avoid this problem by appealing to the concept of equality. What prevents pride from cropping up is a **sober estimation of one’s faith**, and this sober estimation is based on the truth that God apportioned to each one a measure of faith.

B. (:4-5) Transformed Thinking about Others – To Promote Unity via Diversity in the Body

1. (:4) Lesson of Unity via Diversity from Physical Body

*“For just as we have many members in one body
and all the members do not have the same function,”*

2. (:5) Application of Unity via Diversity from Body of Christ

*“so we, who are many, are one body in Christ,
and individually members one of another.”*

Thomas Schreiner: Paul wanted to emphasize that the **unity** of the body is by definition characterized by **diversity** (**Dunn** 1988b: 725). Any notion that the unity of the body would lead to a flat kind of equality in which all the members had the same gifts or even the same amount of faith is excluded.

C. (:6-8) Transformed Thinking about Our Gifts – To Exercise Our Unique Giftedness to Build Up the Body

1. Proper Exercise of Spiritual Gifts in Accordance with God’s Grace

*“And since we have gifts that differ according to the grace given to us,
let each exercise them accordingly.”*

Frank Thielman: God’s grace has equipped people to help the whole body of believers in different ways, and believers should fill the role God has assigned them in a humble way, recognizing that these roles originate with God, not with their own ability or cleverness.

Michael Gorman: The seven gifts Paul enumerates in **12:6–8**—the number seven probably being intentional and symbolic—are not meant to be an exhaustive but a significant **representative list** of the gifts of grace, suggesting that **God provides all that the body needs:**

1. prophecy: speaking a specific, Spirit-inspired word to the assembly;
2. ministry/service (*diakonia*): possibly referring to serving people’s material and physical needs;
3. teaching: general instruction in the faith, but also analysis and critique of the unchristian habitus of this age/world;
4. exhortation, or possibly encouragement (*paraklēsis*): probably meaning general or specific moral instruction, but possibly spiritual support;
5. giving: providing financial support to the assembly or its members, or both;
6. leading, or having authority: providing oversight for the life of the community; and
7. compassion (lit. “*practicing mercy*”): what the church would later call the works of mercy, including visiting the sick and imprisoned, sheltering the homeless, and so on.

Grant Osborne: When studying this list of gifts, one might imagine the characteristics of the people who would have them.

- Prophets are often bold and articulate.
- Servers (those in ministry) are faithful and loyal.
- Teachers are clear thinkers.
- Encouragers know how to motivate others.
- Givers are generous and trusting.
- Leaders are good organizers and managers.
- Those who show mercy are caring people who are happy to give their time to others.

2. Proper Understanding of Spiritual Gifts and What is Required of Each

a. Prophecy

“if prophecy, according to the proportion of his faith;”

Frank Thielman: The gift of prophecy enabled people to encourage, edify, and comfort the church (**1 Cor 14:3–4**) and to speak so incisively to outsiders who were present that they might “*worship God and declare that God is really among you*” (**1 Cor 14:24–25**; cf. **Acts 15:32**). Prophets commissioned people for certain tasks (**Acts 13:1–3**; **1 Tim 4:14**), predicted future events (**Acts 11:27–30**), and directed the church’s mission on the basis of this knowledge (**Acts 21:10–11**).

Thomas Schreiner: The gift of prophecy should not be equated with preaching or teaching. **First Corinthians 14:29–33** suggests that prophets received **spontaneous revelations** that they proceeded to share with the congregation. The congregation or the other prophets were then called on to judge the validity of the prophetic utterances (cf. **1 Cor. 14:29–33**; **1 Thess. 5:19–22**). Instances of such spontaneous revelations are recorded in the prophecies of Agabus, who predicted that a famine would occur during the reign of Claudius (**Acts 11:28**), and he also

prophesied that the Jews would bind Paul and deliver him over to the gentiles (**Acts 21:10–11**). It seems that prophecy is not only spontaneous in nature but is also **directed to concrete situations**, giving practical guidance in particular circumstances. The gift can't be described as charismatic exegesis, nor is it equivalent with preaching and teaching, though it doesn't follow from this that preaching and teaching were absent from prophecy (rightly **Schnabel 2016: 601**). **Schnabel (2016: 602)** gives seven features of prophecy:

- (1) Prophecy is inspired by the Spirit and reveals God's will and his divine plan. It may be spontaneous or may also involve prior reflection.1
- (2) In contrast to tongues, prophetic speech is instantly comprehensible.
- (3) Prophetic speech isn't ecstatic. In other words, prophetic speech can be controlled.
- (4) All believers should seek the gift of prophecy.
- (5) Prophecy edifies and encourages the community (**1 Cor. 14:3, 31**).
- (6) Prophetic speech may involve divine insight into a particular situation, speak to unbelievers, or foretell the future.
- (7) Prophecies must be weighed and judged by the church (**1 Cor. 14:29**).

b. Service

“if service, in his serving;”

Thomas Schreiner: Paul's main point is that those who have such gifts should **devote themselves to the gift that they have received**. . . Paul makes these statements because **discipline** and **perseverance** are needed to use one's gifts to the maximum benefit.

c. Teaching

“or he who teaches, in his teaching;”

d. Exhortation

“or he who exhorts, in his exhortation;”

Thomas Schreiner: The perennially needed appeal to action, sacrifice, and overcoming what is sinful is likely given priority in *paraklēsis*. **Teaching** concentrates more on the content of the tradition, while **exhortation** summons others to actions and stirs them from lethargy.

e. Giving

“he who gives, with liberality;”

f. Leading

“he who leads, with diligence;”

g. Showing Mercy

“he who shows mercy, with cheerfulness.”

Thomas Schreiner: The **gift of mercy** is present when one has a special ministry to the sick, to those who are suffering emotionally, or to those experiencing some distress, which could include the need for economic assistance. Those who exercise such a gift must do so with *“cheerfulness”* (*ἡλαρότητι, hilarotēti*). The same root word is found in **2 Cor. 9:7**, which says that *“God loves a*

cheerful [ἡλαρόν, *hilaron*] *giver*.” The one who shows mercy must not have a begrudging spirit that communicates to the person on the receiving end that the mercy given is a debt instead of a joy (cf. **Prov. 22:8a LXX**; **Sir. 35:11 [35:8 LXX]**; **Philo, Spec. Laws 4.13 §74**; **T. Job 12.1**). The kind of mercy that honors God and shows love to the recipient is filled with joy and finds it a greater blessing to give than to receive (**Acts 20:35**).

Frank Thielman: The final gift, showing “*mercy*” (ἐλεῶν), forms a bridge to the next paragraph, which describes genuine love (**Rom 12:9–21**). It also reaches back into the preceding argument that all believers have been the objects of God’s “*mercy*” (**9:15, 18; 11:30–32**; cf. **12:1**). In the preceding section of the argument, “*showing mercy*” (ἐλεέω) and “*showing compassion*” (οἰκτερμέω) meant rescuing not merely those who did not deserve it but showing grace to the “*disobedient*” (**11:30–31**). It meant loving the sinner and reaching out to the enemy in reconciliation (**5:6–11**; cf. **12:17–21**).

* * * * *

DEVOTIONAL QUESTIONS:

- 1) What is your **motivation** for following Jesus Christ as the Lord of your life?
- 2) Why is the **commitment** called for here not just a one-time climactic experience?
- 3) What are some of the sinful tendencies of your personality that still need to be **transformed** by the renewing of your mind by the Spirit of God?
- 4) Why does Paul include the **gift of prophecy** here if that is a temporary gift for the foundation of the church?

* * * * *

QUOTES FOR REFLECTION:

Grant Osborne: What is Sacrificial Living?

- Be nonconformists—Consciously resisting the suggestions and pressures of the world around us.
- Renew our minds—Constantly asking God to teach us to think as he thinks.
- Estimate ourselves honestly—Having neither false humility nor inappropriate pride in our serving relationships with others.
- Utilize our gifts—Identifying those gifts to be used in helping others; finding a purpose, a place, and a position to serve other believers.

What Cause Us to Conform to the World’s Pattern?

- We believe that the world is more likely to allow us pleasure than God is.
- We find a certain exhilaration in rushing along with the world.

- We are afraid of what might happen if we really think about life and change.
- We are crippled by pride or a negative self-image and believe there really isn't an alternative.
- We reject the life of service and humility necessary to conform ourselves to God's pattern.

Conforming to the world's pattern will involve the following ways of thinking:

- We have a right to have all our desires fulfilled (see **Romans 8:5; 1 Peter 4:3-4**).
- We have a right to pursue and use power (see **Mark 10:42-45**).
- We have a right to abuse people (see **Luke 11:43, 46-52**).
- We have a right to accumulate wealth for purely selfish reasons (see **Matthew 16:26**).
- We have a right to use personal abilities and wisdom for self-advancement rather than for serving others (see **1 Corinthians 3:19**).
- We have a right to ignore or even hate God (see **James 4:4**).

Frank Thielman: Paul's emphasis lies on the humility and sincere inner conviction with which believers should fulfill the role within the church that God has assigned to them (**Rom 12:3**). The church is not the place for comparison between individuals to determine whose role is more important, nor for competition among individuals for supposedly more prestigious roles. It should instead be a place where the sort of competitiveness that dominated ancient Rome is turned upside down. As Paul says in the next paragraph, the church should be a place where people "*lead one another forth with respect to honor*" (**12:10**). They should, in other words, provide examples to one another of honoring not themselves but others. Competition and seeking honor for one's self are no less a part of modern human societies than they were of ancient Roman society. Paul's call upon believers to be vigilant against allowing this spirit to infect the church is as relevant now as it was in his own time. A critical component in the transformed existence of both the individual believer and the church is a spirit of humility and an enthusiasm for doing good to others. Paul calls this love, and that forms the topic of his next exhortation (**12:9-21**).

Douglas Moo: The implication of the relationship between **verses 1-2** and **verses 3-8** is that I cannot fully "*renew my mind*" without the active help of other believers. I cannot understand what Scripture teaches apart from dialog with others who are reading that same Scripture. I cannot live the life of a disciple of Christ apart from the nurturing context of a community of believers who encourage me, pray for me, and set an example for me. I cannot discern the blind spots in my obedience to Christ without other believers to point them out to me. Here is where the attitude of arrogance that Paul rebukes in **verse 3** can get in the way. We think of ourselves "*more highly than [we] ought*" and so conclude that we do not need the help of others.

More directly taught in the text, **I must participate in the local church** to help others grow. Whatever gift I have been given, I am under obligation to my Lord to use it to serve his people. That gift need not always, of course, be expressed only in a local church. The writing I am doing right now is, I hope, an expression of one of my gifts that serves the church at large. Most of the teaching that I do is apart from the local church context. Moreover, how the seminary, certainly a ministry of the church in general, relates to the local church in Pauline terms is not easy to sort out. But this much can certainly be said: The gifts God has given us are generally to be exercised

in local churches. Other Christians need what each of us has to offer. As the human body is at a disadvantage without a foot, or an eye, or a kidney, so **the local church is harmed when the full panoply of gifts are not being exercised within it.**

John Toews: Paul illustrates the exhortation to correct thinking by referring to the community as a **body**, a common metaphor in ancient political thought. A community or a city was compared with the human body to encourage **cooperation** and **unity**.

The first line of the metaphor speaks of **diversity**, many different members with different functions. The second line centers the diversity—the many are one body in Christ, which is further defined as members one of another. The third line exhorts the use of the different gifts given by God to each member. Seven gifts are identified. Prophecy denotes the spiritually inspired but rational ability to discern and declare God’s workings in the community and God’s will for the church. The value of the gift is determined by its origin in faith and by its capacity to strengthen faith (the measure of faith refers to the source of the prophetic word, i.e., a word from God, and to the results of the measurement). The gift of service provides acts of service to the community. The one who teaches passes on and interprets the teachings of the faith. The one who exhorts nurtures the practice of the ethical implications of the faith. The gift of charity from one’s own resources must be exercised with simplicity. The patron who provides financial support for those in need must demonstrate earnest dedication. The gift of mercy must be bathed in a cheerful spirit. Each gift is to be exercised faithfully for the benefit of the whole community (see **1 Cor. 12** and **Eph. 4** for other gift lists with similar concerns for **unity in diversity**).

The point of the metaphor is that the **sum is greater than the parts**; the Roman Christians must learn to see themselves as interdependent parts of a larger whole. All parts are important and needed for the well-being of the whole. No part should think arrogantly about its importance or role. Thinking too highly of oneself is inappropriate, because each gift is defined by being members one of another. **The churches are composed of interdependent people.**

Steven Cole: Let’s try to **define humility**. **Vernon Grounds** wrote (*Zondervan Pictorial Encyclopedia of the Bible*, ed. by Merrill C. Tenney [Zondervan], 3:222), “It is the spontaneous recognition of the creature’s absolute dependence on his Creator . . .” He adds (3:223), “Humility is the logical corollary of sin-consciousness.”

In one of the few books written on humility (*Humility: The Beauty of Holiness* [Christian Literature Crusade], p. 12), **Andrew Murray** calls it “the place of entire dependence on God.” He adds (p. 13, italics his), “Humility is not so much a grace or virtue along with others; it is the root of all, because it alone takes the right attitude before God, and allows Him as God to do all. . . . It is simply *the sense of entire nothingness, which comes when we see how truly God is all, and in which we make way for God to be all.*”

In his excellent little booklet, *From Pride to Humility* (rev. ed., excerpted from *The Exemplary Husband* [Focus Publications], p. 17), **Stuart Scott** says,

When someone is humble they are focused on God and others, not self. Even their focus on others is out of a desire to love and glorify God. . . . A humble person’s goal is to

elevate God and encourage others. In short, they “*no longer live for themselves, but for Him who died and rose again on their behalf*” (2 Cor. 5:15).

Then he offers this definition (p. 18): “The mindset of Christ (a servant’s mindset): a focus on God and others, a pursuit of the recognition and the exaltation of God, and a desire to glorify and please God in all things and by all things He has given.”

Here’s another helpful definition, from **C. J. Mahaney** (*Humility: True Greatness* [Multnomah], p. 22, italics his): “*Humility is honestly assessing ourselves in light of God’s holiness and our sinfulness.*” He adds (*ibid.*), “Without an honest awareness of both these realities ... all self-evaluation will be skewed and we’ll fail to either understand or practice true humility.”

So we could sum up that **true humility means seeing God as the giver and sustainer of everything and seeing ourselves as sinful and needy in His presence, so that we trust totally in Him and not in ourselves, so that He gets all the glory.**

Steven Cole: Years ago, **Gene Getz** wrote a helpful book, *Building Up One Another* [Victor Books, 1976], in which he examined many of the “*one another’s*” in the New Testament. He said (p. 4) that outside of the gospels, there are 58 uses of the Greek word that is usually translated “*one another.*” His 12 chapter headings were:

1. “*Members of One Another*” (Rom. 12:5)
2. “*Devoted to One Another*” (Rom. 12:10)
3. “*Honor One Another*” (Rom. 12:10)
4. “*Be of the Same Mind with One Another*” (Rom. 15:5)
5. “*Accept One Another*” (Rom. 15:7)
6. “*Admonish One Another*” (Rom. 15:14)
7. “*Greet One Another*” (Rom. 16:3-6, 16)
8. “*Serve One Another*” (Gal. 5:13)
9. “*Bear One Another’s Burdens*” (Gal. 6:2)
10. “*Bearing with One Another*” (Eph. 4:2)
11. “*Submit to One Another*” (Eph. 5:21)
12. “*Encourage One Another*” (1 Thess. 5:11)

Note that many of these references come from Romans. All of them are specific ways to show love for one another (John 13:34-35). **Getz’** point is that the New Testament has a strong emphasis on the fact that we are not to be Christians in isolation, but in relationship with one another.

Leedy Greek NT Diagrams:

Rom 12:1-2

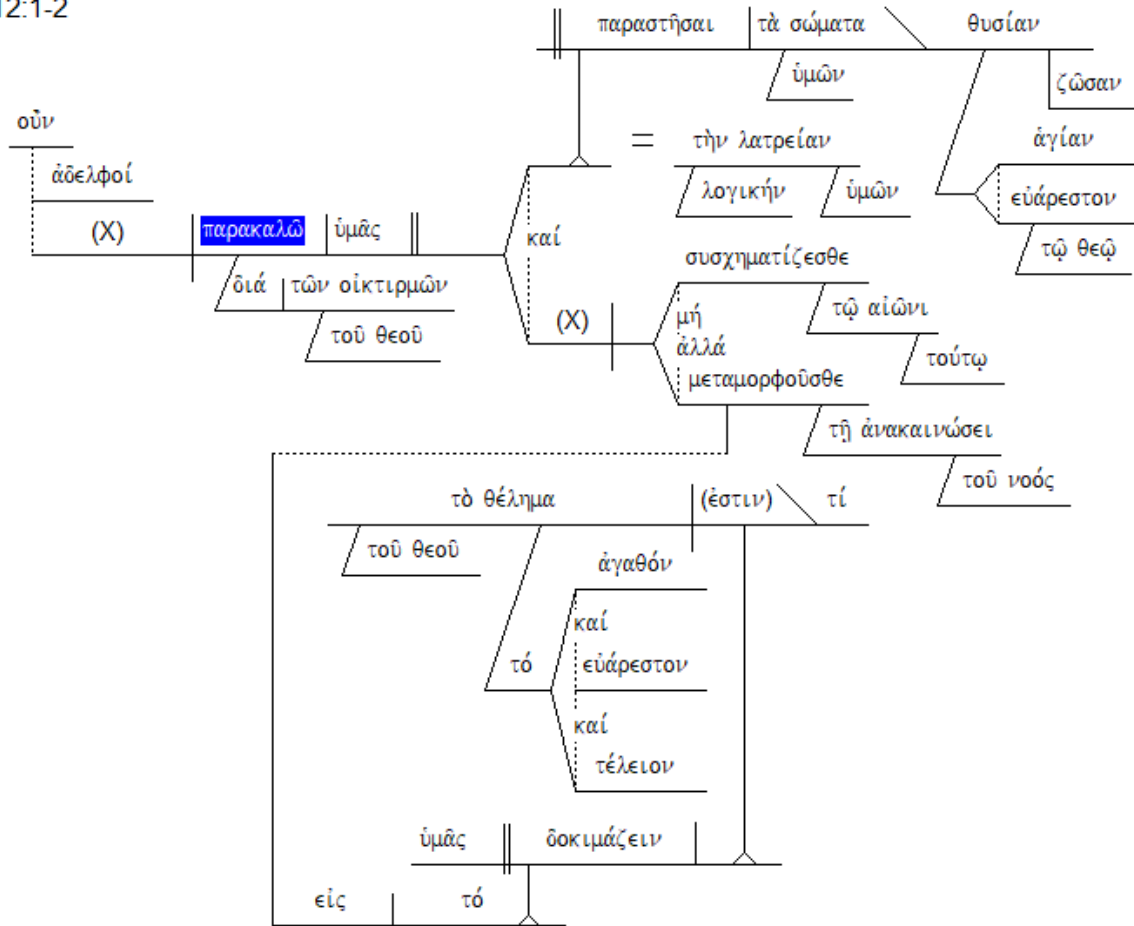

Rom 12:3

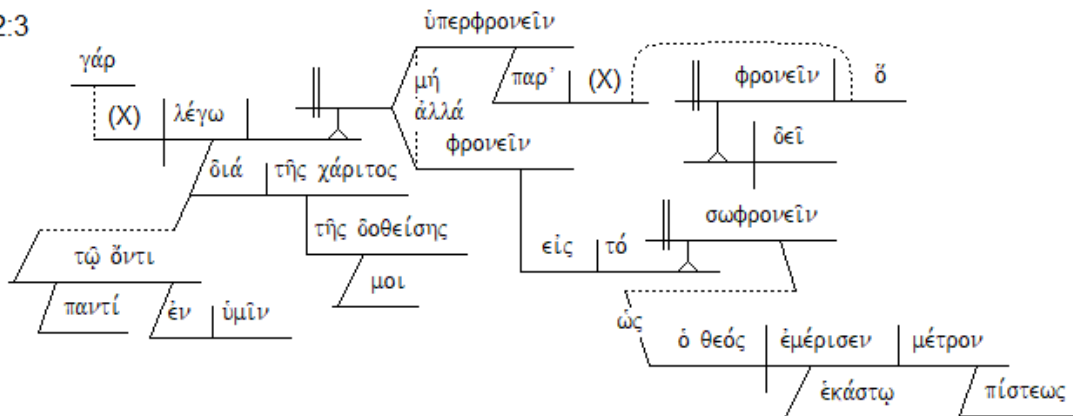

Rom 12:4-5

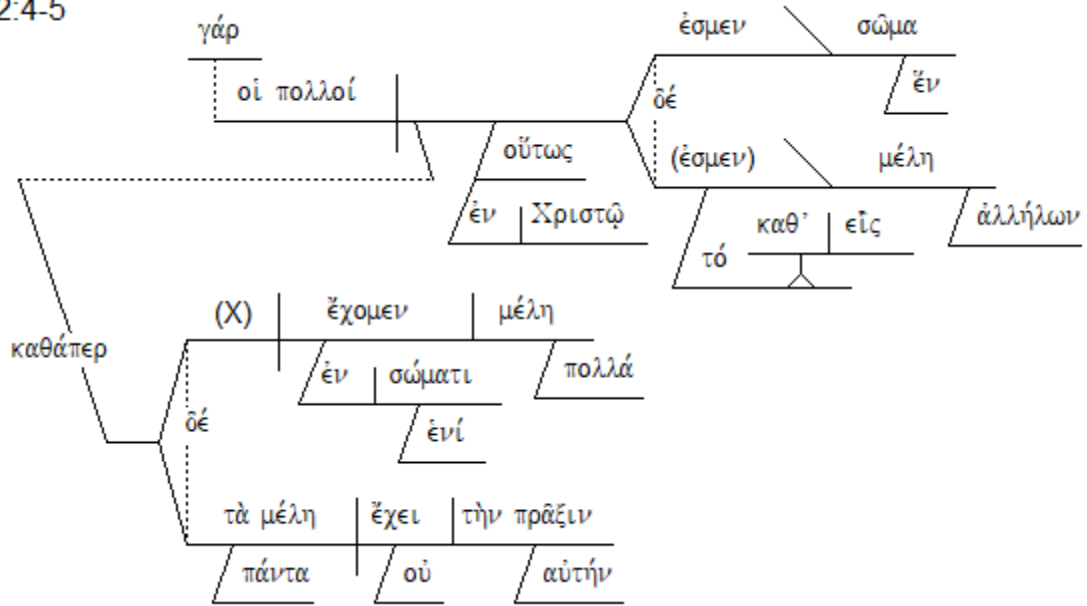

Rom 12:6-8

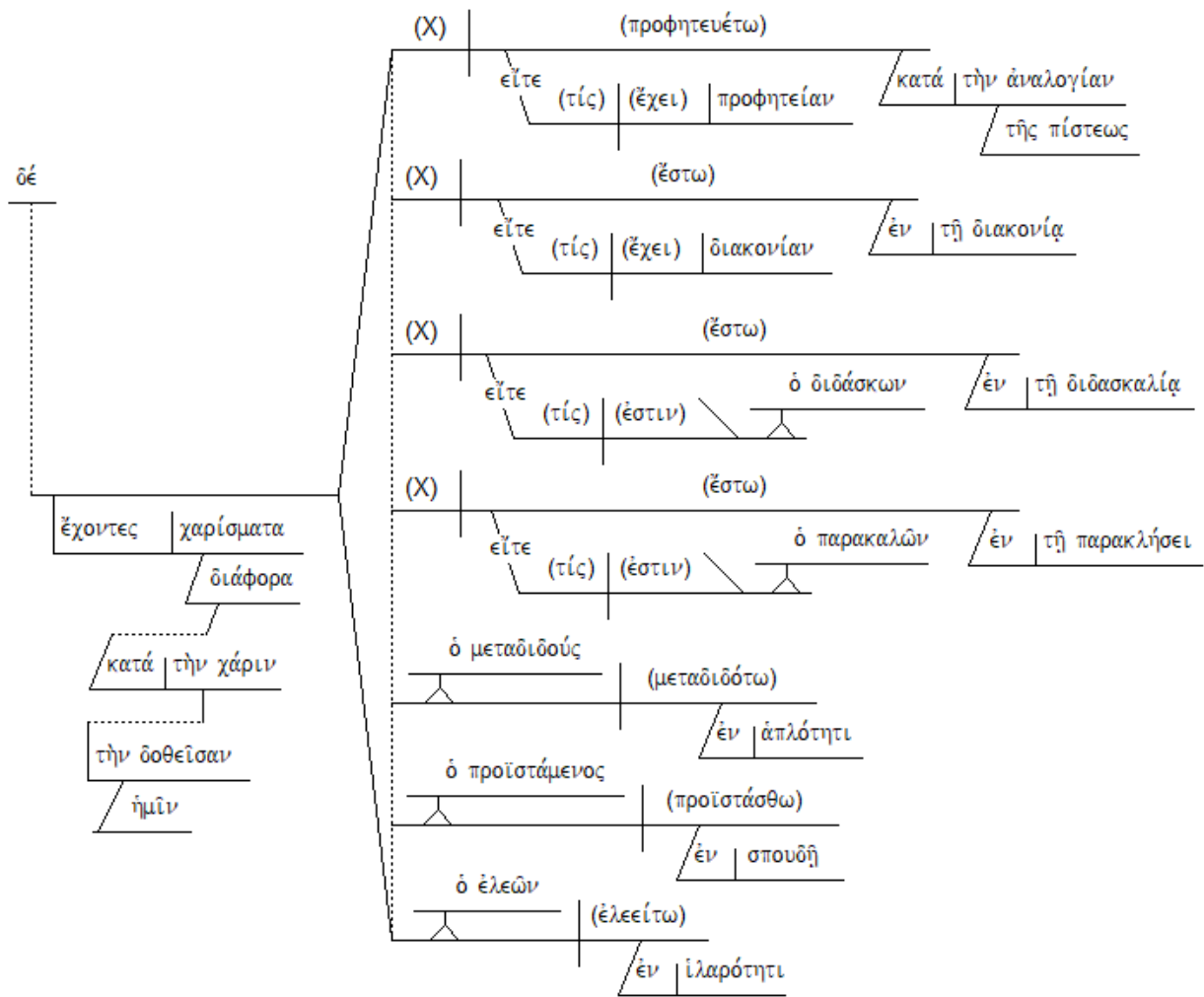

Frank Thielman:

- 1a Exhortation **I appeal to you**, therefore, brothers and sisters,
|
| through God's compassionate actions,
to offer your bodies as a sacrifice
- b Description that is living, holy, and pleasing to God,
- c Apposition which is your reasonable worship.
- 2a Exhortation And **do not be conformed** to this age,
- b Contrast but **be transformed** by the renewal of your mind
c Result (of 2b) so that you might approve what the will of God is
d Apposition (to 2c) —that [you may approve, in other words, that] which is good and ☩
pleasing and perfect.
- 3a Expansion (of 1–2) For **I say**
to everyone among you,
through the grace given to me,
not to think too highly,
beyond what one ought to think, but
to think sensibly,
each one just as God has apportioned ☩
them a measure of faith.
- 4 Description (of 3) For just as we have many members in one body, and all the members do not have the ☩
same function.
- 5 Comparison (to 4) So, we the many are one body in Christ, and each one members of one another.
- 6a Slight contrast (to 5) But, having different gifts according to the grace given to us, **[let us use them sensibly,]**
b List (1) whether prophecy in proportion to faith,
7a List (2) whether ministering, in ministry,
b List (3) whether the one who teaches, in teaching,
8a List (4) whether the one who exhorts, in exhortation,
b List (5) the one who shares, in sincerity,
c List (6) the one who leads, with diligence,
d List (7) the one who shows mercy, with cheerfulness.

TEXT: ROMANS 12:9-13

TITLE: LOVE IN ACTION -- AUTHENTIC AND ACTIVE LOVE

BIG IDEA:

WE ARE TO SERVE GOD WITH LOVE THAT IS BOTH AUTHENTIC AND ACTIVE

INTRODUCTION:

Frank Thielman: Paul has not lost sight of the thesis he announced in **12:1–2** that the conduct he describes in **12:3 – 15:7** should arise from within the believer as the result of a transformed and renewed mind. Just as sincerity, diligence, and cheerfulness should characterize those who use their gifts in the body of believers (**12:8**), so their day-to-day practical expressions of love should be sincere, reflecting their new heartfelt convictions (**v. 9a**). They should not merely stay away from evil, but loathe it (**v. 9b**). They should not merely do what is good, but cling to it (**v. 9c**). Their love for one another should well up from within, like the instinctive love of a mother in the animal world for its young (**v. 10a**). Their commitment to the life of faith should be marked by enthusiasm, ardor, heartfelt service, joy, endurance, and devotion (**vv. 11–12**). These terms describe conduct that is not imposed from without by an external authority but arises from a transformed mind and a will that is now released from the wretched bondage to sin described in **7:13–25**.

Steven Lawson: So, everything to this point has been intensely **doctrinal**, and then even in **Romans 12 verses 1 through 8** it has been **general requirements** of us as believers to present our bodies as a living and holy sacrifice and exercise our spiritual gifts, but now beginning in **verse 9**, suddenly Paul becomes, let me say, painfully specific. This is where **Christianity gets real**. This is where the rubber meets the road, men. This is taking Christianity out of the ethereal and down into the real. This is down in the weeds. This is where you and I are to live every moment of every day. This is personal holiness spelled out.

Mounce: Nowhere else in Paul's writings do we find a more concise collection of **ethical injunctions**. In these five verses are thirteen exhortations ranging from love of Christians to hospitality for strangers. There are no finite verbs in the paragraph. There are, however, ten participles that serve as imperatives. In the three other clauses (**vv. 9, 10, 11**) an imperative must be supplied. Each of the thirteen exhortations could serve as the text for a full-length sermon. What they deal with are basic to effective Christian living.

Grant Osborne: The key ingredient in interpersonal relationships is **love**—God's love (*agape*). This kind of love is a **self-sacrificial love**, a love that **cares for the well-being of others**. All the gifts that are exercised in the body should be expressed in this love. This love is the most accurate indicator of spiritual health in the body of Christ. To the Ephesians Paul wrote, "*Speaking the truth in love, we will in all things grow up into him who is the Head, that is, Christ. From him the whole body, joined and held together by every supporting ligament, grows and builds itself up in love, as each part does its work*" (**Ephesians 4:15-16 NIV**). Believers have God's love within because "*God has poured out his love into our hearts by the Holy Spirit,*

whom he has given us” (5:5). For our love to be different from most of what is called “love” in the world, it must be genuine—without hypocrisy, deceit, falseness. Sincere love is genuine love. Jesus was referring to this kind of love when he said, “A new command I give you: Love one another. As I have loved you, so you must love one another. By this all men will know that you are my disciples, if you love one another” (John 13:34-35 NIV).

I. (:9a) LOVE MUST BE AUTHENTIC (GENUINE, SINCERE)

“Let love be without hypocrisy.”

Emphasis on love forms a natural **transition** from the use of spiritual gifts to build up the body (a function that cannot succeed apart from love) to some of the more practical manifestations of love.

Steven Cole: The English word “*sincere*” comes from two Latin words meaning, “*without wax*.” Dishonest merchants would fill a crack in a pot with wax and glaze over it, selling the defective pot as if it were just fine. Only later would the buyer discover that the pot was worthless. So honest dealers would stamp *sine cera* on the pot, verifying that it was without wax.

The Greek word that Paul uses means “*without hypocrisy*.” The word was used of the masks used by actors on the stage. You have probably seen these in advertisements for stage plays in our day. Some of the masks were happy, others were sad. The actor did not necessarily feel as the mask signaled, but the mask showed the role that he was playing. Paul says that our love for one another is not to be a phony mask or role playing, but rather be the real thing. We should genuinely desire God’s best for others and speak and act toward that goal.

Grant Osborne: Genuine Love

Most people know how to **pretend to love others**—how to speak kindly, avoid hurting their feelings, and appear to take an interest in them. We may even be skilled in pretending to feel moved with compassion when we hear of others’ needs, or to become indignant when we learn of injustice. But God calls us to **real and sincere love** that goes far beyond politeness. Sincere love requires concentration and effort. It means helping others become better people. It demands our time, money, and personal involvement. No individual has the capacity to express love to a whole community, but the body of Christ in your town does. Look for people who need your love, and look for ways you and your fellow believers can show your Christian love to others.

Steven Lawson: What is love? Love is sacrificially giving of yourself to seek the highest good in another. Love is always giving, not taking. Lust takes; love gives. And you give in a costly manner, costly to you. It is sacrificial giving. So, love is selfless, love is self-giving, love is self-denying, love is sacrificial, and I think it is really because love is so important in the Christian life. There is a sense in which it is at the very epicenter of the Christian life, that it is really worth our taking these few moments to drill down and to underscore what love is and why it is so important. If I genuinely love you from the heart, I will promote your best interests. I will do what will build you up and affirm you and help you in the Christian life. Love is others-oriented.

Frank Thielman: The term Paul uses for “love” (ἀγάπη) referred to esteem and affection demonstrated in practical ways. In the preceding argument, God has demonstrated his love for believers by providing them with the sustaining presence of the Holy Spirit (**Rom 5:5**) and with reconciliation to himself through the death of Christ (**5:8; 8:32, 35, 37, 39**). In a way that is consistent with his exhortation to sincere service to the body of believers in **12:8b–d**, then, Paul urges the Romans not merely to demonstrate their love in practical ways but to do so without insincerity (cf. **2 Cor 6:6**).

John Toews: To love without hypocrisy involves moral judgment, distinguishing good from evil and then pursuing the good. The discernment of the good here and in **12:17 - 13:10** expands on the same theme from **12:2**. The transformed mind seeks the good. True love, like the will of God, involves **discriminating moral choices**.

James Dunn: ἀνυπόκριτος means literally “without hypocrisy,” so “genuine, sincere.” The word is found also with reference to love in **2 Cor 6:6** and **1 Pet 1:22**; with regard to “faith” in **1 Tim 1:5** and **2 Tim 1:5**; elsewhere in biblical Greek only **Wisd Sol 5:18; 18:16**; and **James 3:17**. The ὑποκριτής was the “play-actor” who projects an image and hides his true identity behind a mask. Paul would be conscious no doubt of the danger of deceit, including self-deceit, not least in the matter of spiritual gifts and enablings (cf. **Cranfield**; and see below).

II. (:9b-13) LOVE MUST BE ACTIVE (PRACTICAL)

A. (:9b) Pursue Holiness – Love’s Morality

1. Negatively: Hate Evil

“Abhor what is evil;”

2. Positively: Cling to What Is Good

“cling to what is good.”

Frank Thielman: Both terms, then, emphasize alignments that arise from one’s basic commitments and inner feelings, and this idea unites these two admonitions with the maxim about sincere love and also with the implied admonitions in **Romans 12:8b–d**. The believer’s renewed mind and transformed existence (**12:2**) should reveal itself in love that is not mere display, in a genuine inner revulsion at what is evil, and in a heartfelt alignment with what is good.

Thomas Schreiner: Those who belong to the people of God are “to hate” (the participle ἀποστυγοῦντες is a strong term for hatred) what is evil and “cleave to” (κολλώμενοι, kollōmenoi) what is good. True virtue is not passive about evil but has an intense revulsion against it. Evil is not tolerated but is despised as that which is injurious and wicked. “Where there is love, evil is abhorred, not merely lamented, much less covered up, but hated” (**Schlatter 1995: 235**). Conversely, the righteous have a strong affinity for what is good, so that they seek it fervently and cling to it no matter what the cost.

Douglas Moo: At the end of **verse 9**, he briefly unpacks the basic **moral dimension** of sincere love in two parallel clauses (using a participle in Greek). Christian love is more than a feeling; it

leads to a violent hatred of evil and a tenacious attachment to what is good (the verb for “cling,” *kollaomai*, refers to sexual relations in **1 Cor. 6:16, 17**). With John, Paul would argue that no one truly loves who does not obey God’s command (see, e.g., **2 John 6**).

B. (:10) Prefer Others – Love’s Concern for Others

1. Brotherly Love

“Be devoted to one another in brotherly love;”

Grant Osborne: Paul’s charge goes against the value of rugged individualism—the attitude of “doing it all by myself.” Believers are to show brotherly love to fellow believers, and respect all the gifted people in the church, not just those whose gifts are visible. That’s the only way that the body of Christ can function effectively and make a positive impact on the unbelieving world. The Greek word for “be devoted” (*philostorgoi*) means the type of loyalty and affection that family members have for one another. This kind of love allows for weaknesses and imperfections, communicates, deals with problems, affirms others, and has a strong commitment and loyalty to others. Such a bond will hold any church together no matter what problems come from without or within.

John MacArthur: Now, *philostorg* combines two words then, *storg*, which means a **natural love**, not a love induced by desire, not a love induced by beauty or an attractive personality but the natural love that occurs within a family, normal, natural, kindred love, as opposed to love that is generated by attraction, personality, beauty, lust, desire, circumstance or anything like that. It is just normal family love. And it’s marvelous that he use it here because he says in the Christian family, we ought to have a *phile* type family love. And *phile* talks about the **warm affection** of love.

2. Preferential Love

“give preference to one another in honor;”

Frank Thielman: “To have nothing was to be nothing in the Roman world. There was a culture where people strove to look down on their neighbours with something of the same disdain that the elite looked down on them.” [**Jerry Toner**] Here Paul insists that believers, whose thinking God has refashioned (**12:1–2**), must live by a radically different standard. They must renounce the vicious competition for honor that dominated Roman society, and instead make sure that others receive honor.

Bruce Hurt: To **honor someone** is to show genuine appreciation and admiration for the other individual. Believers who are being transformed by the renewing of their mind should be becoming more and more sensitive to showing respect, to acknowledging the accomplishments of others, to demonstrating genuine love by not being jealous or envious. These are the marks of a sincere faith which is maturing. Such a one in fact is to take the lead in the carrying out of these actions. If we have truly presented ourselves as a living sacrifice, we should be growing in these graces (and they can only be carried out by His empowering grace).

C. (:11) Passionate in Service – Love’s Zeal for Serving the Lord

1. Defined by Diligence

“not lagging behind in diligence,”

Grant Osborne: Fatigue may be part of the cycle of service, but apathy (**lack of zeal**) should not be part of a believer’s life. Christians must fight against discouragement, depression, and negativeness; they must do their utmost to keep their spiritual temperature high.

John MacArthur: There has to be haste. There has to be intensity in the Christian life. There's no room for laziness. We could spend a lot of time going back to the book of Proverbs and doing an entire study on laziness and how appalling laziness is to God. Suffice it to say at this point, there is no room for laziness in the work of the Lord. There is no room for indolence. It demands hastiness, a hurry, a spirit that is moving fast.

2. Defined by Fervency *“fervent in spirit,”*

Thomas Schreiner: Believers are *“not to be lazy in diligence”* (τῆ σπουδῇ μὴ ὀκνηροί, *tē spoudē mē oknēroi*) but are to burn in their spirits and serve the Lord. The word ὀκνηρός (*lazy*) is often used for indolence or slackness (**Matt. 25:26**; in the LXX see **Prov. 6:6, 9; 26:13–16; Sir. 37:11**). Instead of caving in to inactivity, believers are to be diligent and earnest and disciplined. The counterpart to laziness is **fervency**, which is expressed in the words τῷ πνεύματι ζέοντες (*tō pneumati zeontes, burning [with zeal] in spirit*). The parallel in **Acts 18:25** is notable, for there it is said that Apollos was *“burning in Spirit”* (ζέων τῷ πνεύματι). The only debate here is whether *“burning in spirit”* relates to the Holy Spirit or to the human spirit. Interestingly, scholars on both sides appeal to the parallel in **Acts 18:25** as if that text definitively settles the issue.

Determining which view is correct is again difficult, since the issue can hardly be resolved by appealing to wider contextual evidence. Decisions like these can be made only by consulting the Pauline usage elsewhere. Most often πνεῦμα refers to the Holy Spirit, yet references to the human spirit also occur (e.g., **Rom. 1:9; 1 Cor. 5:4; 14:14, 15; Gal. 6:18; Phil. 4:23; 1 Thess. 5:23**). In some instances both the Holy Spirit and the human spirit seem to be intended (**1 Cor. 5:3–4; 14:14–16**), for Paul slides from the one to the other rather easily. Perhaps the latter suggestion is the most promising in this instance as well (**Sanday and Headlam 1902: 361**). Believers are to burn and seethe in their spirits, but the means by which this is done is the power of the Holy Spirit. A reference to the Holy Spirit is also suggested by the image of boiling because the Holy Spirit is often associated with fire (**Isa. 4:4; 30:27–28; Matt. 3:11; Luke 3:16; Acts 2:3; 1 Thess. 5:19; Rev. 4:5; Dunn 1988b: 742; Schnabel 2016: 624–25**).

James Dunn: τῷ πνεύματι ζέοντες, *“aglow with the Spirit.”* The precise force of ζέω is uncertain, but the imagery is clear enough. The basic sense is *“bubble, boil”* (as of water, as in **Ezek 24:5**), with the thought of heat a natural correlation (so of the process of fermentation, as in **Job 32:19**, and of glowing iron, as in **Josephus**, War 5.479). The metaphorical application to burning passion (**Plato**, Republic 4.440C; **Philo**, Sac. 15; **Heres** 64) or rage (**4 Macc 18.20; Philo, Migr. 210; Mos. 2.280**) is natural.

Thomas Constable: Apollos was a model of someone who maintained fervency in his service (**Acts 18:24–25**; cf. **Rev. 3:15–16**), as was Paul. They were *“aglow with the Spirit.”*

Bruce Hurt: In the context of Christian service "*fervent*" means "to be full of energy, to be on fire with zeal and enthusiasm." It is a warning against settling into comfortable, shallow ruts in our spiritual lives. The idea is that believers are to continuously (**present tense** = this is to be our habitual practice, our lifestyle before a critically watching world) be "*hot*" for the things of the Lord.

The idea of the Greek word *zeo* is not of being overheated to the point of boiling over and out of control but, like a steam engine, of **having sufficient heat to produce the energy necessary to get the work done**. That principle is reflected in the life of **Henry Martyn**, the tireless missionary to India, whose heart's desire was to "burn out for God." which is exactly what he did in 6 years!

3. Defined by Ministry "serving the Lord;"

Steven Cole: So Paul isn't describing someone who needs to be arm-twisted into "volunteering" for some ministry until finally he feels guilty and can't figure a way out, so he grudgingly says, "Okay." Rather, he's describing those who are boiling over with zeal to the point that they probably need to be counseled to focus their efforts, because their tendency would be to get involved in just about every opportunity to serve the Lord that comes along.

Jim Elliot, who was martyred in Ecuador at age 28 in his attempt to take the gospel to the fierce Auca Indians, was a man who embodied true godly zeal. If you haven't read his story, you're missing a great blessing. His widow, **Elisabeth Elliot**, wrote *Through Gates of Splendor* [Spire Books], which tells the story of all five men who were murdered. Her book, *Shadow of the Almighty* [Zondervan] focuses more on Elliot's life alone. Jim wrote in his diary (*Through Gates of Splendor*, pp. 19-20, italics in original), "Wherever you are, *be all there*. Live to the hilt every situation you believe to be the will of God." Or, as **Jonathan Edwards** wrote as a young man in his 70 resolutions (*The Works of Jonathan Edwards* [Banner of Truth], 1:xx, # 6): "*Resolved*, To live with all my might, while I do live." Both men are saying, "Don't be indifferent about the Lord and His cause. **Be fervent in spirit!**" . . .

So how should we serve the Lord? First, make sure that your **motivation** is right. You serve Him because of His **great mercies** toward you in the gospel. That motivation moves you not to be lazy, but diligent in serving Him. Serving Christ becomes your **passion**, so that you do it fervently. And, remember that you're serving none other than the Lord Himself.

D. (:12) Persevere in Affliction – Love's Staying Power

1. Perspective "rejoicing in hope,"

John Schultz: **Hope** qualifies the present as an unsatisfactory condition. We must never be satisfied with the condition of imperfection in which we live at present. Even if our physical and emotional state is more than just bearable we must not settle in it as if it were permanent. We are on the road to glory and our present joy draws its strength from the future.

2. Perseverance

“persevering in tribulation,”

John MacArthur: The word **patient** means to stay under, to remain under. We can stay under the pressure. We can stay under the test because we know what's coming. We can endure the trouble, *thlipsis*, the pressure, that's the word pressure. We can stay under the pressure, serving the Lord, reaching out in hope. And because we see what's coming in the future, we rejoice. We rejoice. And we have to go through things. We have to endure the pain. We have to endure the rejection. We have to endure the animosity. We have to endure the struggle with satan and his demons, and all those things that defy what we want to do for the glory of God. But that's not the end of the someday they'll be an eternal victory. We hope in that. That gives us joy, and it allows us to stay under the pressure, to stay under the pressure. And while we're under, **verse 12** says, "We are diligently —" doing what? "*in prayer.*" We're diligently in prayer. I believe one of the reasons the Lord keeps the pressure on is to **keep us in communion with him.**

J Ligon Duncan: The hope of future glory in salvation is able to animate our rejoicing even in the midst in the most real and severe and overwhelming trials in this life. If our ultimate hope was derived even from the desire that bad situations we are in now will eventually become good, we could not rejoice in all circumstance. Not all the bad circumstances that we are in now will be good in the long run in our lives. There will be some things that will never be rectified in this live. That hope of glory, however, enables us to rejoice in every circumstance Paul says, rejoicing in hope. ...When the Spirit enables us to perseverance, the spirit enables us to not simply bear up under stress, to survive the things that we are going through, but the Spirit enables us to continue to be useful in kingdom service despite that stress and despite that trial. Paul is calling on us to manifest this in our Christian life and experience. **Persevering in tribulation.**

3. Prayer

“devoted to prayer,”

Grant Osborne: "*Rejoicing in hope.*" -- This means that we should look forward with happy anticipation to all that God has in store for us. We don't have to fear our future when it is in God's hands. Christ is the reason that we can be joyful.

“Patient in suffering.” -- When believers face trials or persecution, they are to endure patiently, for they know God is in control (see also **5:2-5**).

“Faithful in prayer.” A trademark of believers is prayer, for it is their lifeline to God. They must be persistent in praying, both individually and corporately.

The only way we can be patient in affliction is by faithful prayer and joyful hope. When afflictions come our way, the only joy may be our hope for the future unveiling of God's plan (**8:18-27**).

Steven Cole: **Martyn Lloyd-Jones** observes (ibid., p. 402), “Tribulation, hope and prayer always go together in the New Testament and it is a very good way of testing ourselves to ask whether they always go together in our experience. They should.”

Paul has linked hope, tribulation, and perseverance in **Romans 5:3-5**, “*And not only this, but we also exult in our tribulations, knowing that tribulation brings about perseverance; and perseverance, proven character; and proven character, hope; and hope does not disappoint, because the love of God has been poured out within our hearts through the Holy Spirit who was given to us.*”

And, he links hope, perseverance, and prayer in **8:24-26**, “*For in hope we have been saved, but hope that is seen is not hope; for who hopes for what he already sees? But if we hope for what we do not see, with perseverance we wait eagerly for it. In the same way the Spirit also helps our weakness; for we do not know how to pray as we should, but the Spirit Himself intercedes for us with groanings too deep for words.*” So, again, it is important to keep in mind that just because we have experienced God’s mercies does not mean that we will be exempt from trials. Rather, the Bible shows us how God uses trials to conform us to the image of Christ and to be glorified through us as we joyfully depend on Him in our trials. . .

How can we put **verse 12** into practice? *First, honestly evaluate yourself in light of these three phrases.* Are you grumbling in depression or cynicism? Then you’re not “*rejoicing in hope.*” Are you giving up or despairing in your trials? Then you’re not “*persevering in tribulation.*” Are you grabbing every remedy that the world has to offer to get out of your trials? Then you’re not “*devoted to prayer.*” You can’t begin to grow in these qualities until you honestly evaluate where you’re falling short.

Michael Gorman: The vocabulary of **12:12** is that of **hope in the midst of opposition** and is reminiscent of **5:3–5** (cf. **1 Thess 5:16–18**). Like **12:11**, it has three components:

- believers should be joyful in hope,
- patient in suffering (recall **8:18–24, 31–39**), and
- prayerful in order to persevere.

E. (:13) Provide for the Needs of Others – Love’s Material Giving

1. Generous

“contributing to the needs of the saints,”

Grant Osborne: When some are in need, others who have the means should share what they have in order to meet that need (whether financial or daily necessities). This was another trademark of believers, and it was often what drew nonbelievers to Christianity (see **Acts 2:44-45; 4:34-37; 11:27-30**).

Douglas Moo: According to a literal translation Paul is saying, “*Enter into fellowship with the needs of the saints.*” These needs are **material ones**: food, clothing, and housing (see also **Acts 6:3; 20:34; 28:10; Titus 3:14**).

Steven Cole: 5 Ways to Grow in Generosity:

- (1). YIELD ALL OF YOUR MONEY AND POSSESSIONS TO THE LORD (WHO ALREADY OWNS THEM) AND THEN MANAGE THEM IN LIGHT OF HIS KINGDOM PURPOSES.
- (2). GET A JOB AND WORK HARD TO EARN SO THAT YOU CAN GIVE.
- (3). BEGIN A LIFELONG WAR AGAINST GREED.
- (4). GET OUT OF DEBT, LIVE FRUGALLY, AND ESTABLISH A SAVINGS BUFFER.
- (5). GIVE FAITHFULLY, GENEROUSLY, AND REGULARLY OFF THE TOP OF EACH PAYCHECK. . .

I've recently read several excellent books on the subject of giving. *When Helping Hurts*, by **Steve Corbett & Brian Fikkert** [Moody Publishers] gives many wise and tested insights. For example, the first step in working with the poor is to discern whether the situation calls for relief, rehabilitation, or development (pp. 103-104). When people come to the church needing funds to alleviate a crisis, they recommend asking four questions (p. 106):

1. First, is there really a crisis at hand?
2. Second, to what degree was the individual personally responsible for the crisis? Have they learned from their mistakes?
3. Third, can the person help himself?
4. Fourth, to what extent has this person already been receiving relief from you or others in the past?

Another excellent book is **Jonathan Martin's** *Giving Wisely* [Last Chapter Publishing]. He gives four helpful criteria by which to evaluate your giving, whether overseas or here at home. He uses the acronym RAISE (pp. 61-129):

- Relationship: "A working and viable relationship is the foundation for wise giving."
- Accountability: Giving to anyone without appropriate accountability is a setup for sin.
- Indigenous Sustainability: Our giving should not create dependency on long-term outside help.
- Equity: Our gifts should not create economic inequities in the place it is given.

2. Hospitable

"practicing hospitality."

Frank Thielman: "*Hospitality*" (τὴν φιλοξενίαν) also refers to helping those in need and helping them in practical ways, but refers more specifically to protecting and caring for the traveler or stranger (ξένος). It was a commonly valued virtue in antiquity (e.g., Homer, *Odyssey* 6.207–8, 9.270–71), and the idea that Zeus was the protector of strangers circulated in the Rome of Paul's time as proverbial wisdom (Musonius Rufus, Lecture 15 A [Cynthia King]).

Thomas Schreiner: The other means of assistance noted here is **hospitality**. The use of the participle διώκοντες (*diōkontes, pursue*) suggests taking initiative in providing hospitality. This would be particularly necessary in Paul's day because believers who traveled would typically lack the financial wherewithal to pay their own lodging, and thus their ministry or visit would depend on hospitality (cf. **Heb. 13:2; 1 Pet. 4:9; 1 Clem. 1.2; 10.7; 11.1; 12.1**; Herm. Man. 38.10).

Everett Harrison: Even under persecution one should not allow himself to be so preoccupied with his own troubles that he becomes insensitive to the needs of other believers. Apparently, it is temporal need that is in view. To share with others is never more meaningful than when one is hard pressed to find a sufficient supply for himself. When this sharing takes place under one's own roof, it is labeled "*hospitality*." The Greek term (*philoxenos*) is more expressive than the English, or it means "*love for strangers*."

* * * * *

DEVOTIONAL QUESTIONS:

- 1) What are some of the ways that people are **two-faced** about love?
- 2) Why is it so important to stress that biblical love involves **action** rather than merely feeling?
- 3) Is our love regulated by the boundaries of **morality**?
- 4) How does so much of what we call **hospitality** today fall far short of the type of hospitality talked about in the NT?

* * * * *

QUOTES FOR REFLECTION:

Thomas Schreiner: Some scholars divide the text into two sections: love for Christians (vv. 9–13) and love for unbelievers (vv. 14–21). The call to bless persecutors in **verse 14** is what drives scholars to break up the text in this way. But this division is called into question by **verses 15–16**, for the call to rejoice with those rejoicing, to weep with those weeping, to be united, to forswear pride, and to associate with the humble relate more directly to the church than to the believer's relationship with the world. In particular, the call to unity makes it highly improbable that the believer's relationship with the world is in view. It seems, then, that most of **verses 9–16** has to do with **relationships among believers**. The loose structure of the text is apparent by the insertion of **verse 14** in the midst of this section. Only in **verses 17–21** does the relationship of believers to the world receive prominence. Thus I have split these verses into two sections:

- general exhortations toward love and goodness (vv. 9–16) and
- exhortations for nonretaliation toward enemies (vv. 17–21).

Everett Harrison: **Love is primary**, but if it is not sincere, it is not real love but only pretense. When one recalls that Paul paused in his discussion of spiritual gifts to inject a chapter on love (**1 Cor 13**), it is altogether fitting that he should follow his presentation of spiritual gifts here in Romans with the same emphasis. The whole of the believer's conduct, in fact, should be bathed in love. If he fails to love his brother, doubt is cast on his professed love for God (**1 John 4:19-21**).

Bob Deffinbaugh: What Is This Thing Called Love?

For a number of reasons, Paul regards love as greater even than faith and hope. To show the magnitude of the importance of our study, allow me to summarize these.

- (1) Love is greater than faith and hope because love is eternal, while faith and hope are temporal (see **1 Corinthians 13:8-13**). Because that which God has promised cannot presently be seen, faith and hope are necessary in this life. But when the perfect comes, when our Lord returns and we are living eternally in His presence, we will no longer need faith, for we shall see Him and experience all that He has promised. Our hope will be fulfilled. Our love for Him, however, will last for all eternity, inspiring our worship and service in His presence.
- (2) Love is the appropriate response to God's love and grace, in Christ (see **Luke 7:42, 47**).
- (3) Love is the great commandment and one of the distinguishing marks of a true disciple of our Lord (**Matthew 22:37; Mark 12:33; Luke 6:27-36; John 13:35; 15:12-13**).
- (4) Love facilitates and contributes to Christian unity (**John 17:20-26; Colossians 2:2; 3:14**).
- (5) Love is the lubricant which greatly reduces the friction which can build up between us and others (**Ephesians 4:2; 1 Peter 4:8**).
- (6) Love is a key motive for our obedience to our Lord's commands (**John 14:15, 21, 23, 24; 15:10; 21:15-17; 1 John 5:2; 2 John 1:16**).
- (7) Love is a stabilizing factor in our lives (**Ephesians 3:17**).
- (8) Love is the goal of Paul's teaching as it should be the goal of all Christian teaching (**1 Timothy 1:5**).
- (9) Love is the one command which encompasses all aspects of our Christian life (**Romans 13:8-10; 1 Corinthians 16:14**).
- (10) Love makes our service more profitable to others and to us (**1 Corinthians 8:1; 13:1-13**).
- (11) Love is a key element in our defenses against Satan's attacks and devices (**1 Thessalonians 5:8**).
- (12) Our love can and should be constantly growing (**Philippians 1:9; 1 Thessalonians 3:12; 2 Thessalonians 1:3; Hebrews 10:24; 2 Peter 1:7**).
- (13) Our love can grow cold, especially in difficult times (**Matthew 24:12; Revelation 2:4**).

In the **internal structure** of our text, I see **verse 9** as the general, introductory statement and **verses 10-13** as supporting descriptions of how love is manifested in various ways. **Verse 10** describes Christian love as subordinating self-interest to give preference to the one loved. **Verse 11** describes the energy and diligence which love stimulates, to carry through with those tasks

which build up the other. **Verse 12** points to the future hope which enables Christian love to endure present hardship and adversity. **Verse 13** highlights two particular needs which love should be eager to meet:

- (1) the need for physical and financial help and
- (2) the need for hospitality.

A Preliminary Definition of Love

A preliminary definition of love will be helpful to prepare the way for our study. The following is a composite definition based upon the teaching of the Scriptures as a whole.

Love is the heart-felt affection of the Christian in response to the love God has shown toward us, especially in the gift of salvation through our Lord Jesus Christ. Love is an affection which prompts the Christian to action. Love is first and foremost directed toward God and then toward others in an order of priority: God, family (especially our mate), fellow-believers, our neighbor, and even our enemy. Love subordinates the interests of the lover to the one who is loved. Love inspires our deliberate, diligent, self-sacrificial service to others, which is intended for their good, at our expense.

<https://bible.org/seriespage/31-what-thing-called-love-romans-129-13>

John MacArthur: How do you become self-disciplined?

1. First of all, let me suggest that you start small. Start very small. Here's a simple one: Start with your room. Clean it and keep it that way and learn when something is out of order to put it in order, and when something is out of place, put it in place. Pick it up, put it away.
2. Be on time. It doesn't sound too spiritual but, boy, it's a good one. Be on time. If you're supposed to be somewhere on a certain time, be there at the time you're supposed to be there. Cultivate the ability to sublimate your desires, your activities, the things that pull at you, to be where you're supposed to be on time.
3. Take the hardest job and do it – what? First. And you will force yourself to cultivate discipline.
4. Organize your life. Plan a little, don't just react, plan. Go buy a piece of paper and write on it, “Today I will do this.” Don't just react. If you don't control your life, everything else will. Everything else will.
5. Be grateful for correction. Be grateful for correction because correction helps to make you more disciplined because it shows you what you need to avoid. Don't shun criticism; accept it gladly.
6. Practice self-denial and practice it in a simple way. Want a great big hot fudge sundae? Want it, and order iced tea with NutraSweet. You say, “But I'm thin.” It isn't a matter of thin; it's a matter of cultivating self-restraint. Learn to say no to your feelings.

7. Welcome responsibility. When you have an opportunity to do something that needs to be done, volunteer for it. Welcome responsibility. It forces you to organize yourself.

Leedy Greek NT Diagrams:

Rom 12:9-13

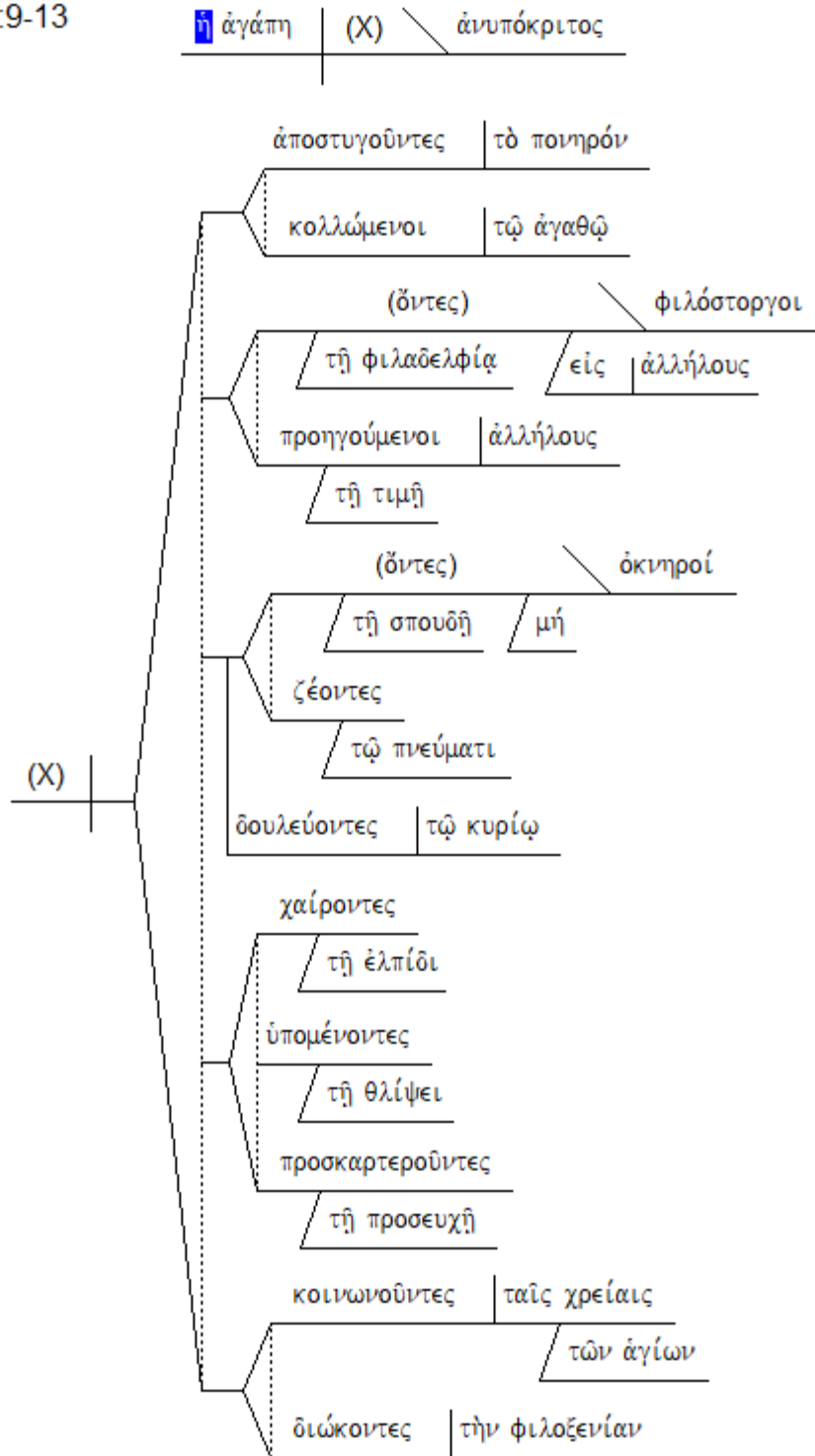

Frank Thielman:

9a	Exhortation	Let love be without pretense.
b	Exhortation	Loathe what is evil.
c	Exhortation	Cling to what is good.
10a	Exhortation	Be authentically loving toward one another
b		with familial affection;
c	Exhortation	lead one another forth
d		with respect to honor.
11a	Exhortation	Do not be lazy
b		in enthusiasm;
c	Exhortation	be ardent
d		in spirit;
e	Exhortation	serve
f		the Lord.
12a	Exhortation	Rejoice
b		in hope;
c	Exhortation	remain firm
d		in affliction;
e	Exhortation	be stubbornly devoted
f		to prayer.
13a	Exhortation	Share
b		in the needs of the saints;
c	Exhortation	pursue
d		hospitality.

TEXT: ROMANS 12:14-21

TITLE: OVERCOME EVIL WITH GOD

BIG IDEA:

**WE ARE TO SERVE GOD BY OVERCOMING EVIL WITH GOOD –
7 WAYS TO FIGHT YOUR ENEMIES**

INTRODUCTION:

Frank Thielman: This passage teaches Christians that the love God expects them to show to others arises from God’s transforming work within them, not from outward coercion. It also contributes to Christian teaching on nonretaliation and provides a strategy for practicing a kind of love for the church’s enemies that does not excuse or perpetuate injustice.

Grant Osborne: Paul now broadens his perspective to the world where the believers live—in this case, the capital of the empire, Rome itself. The community of believers was a tiny segment, vulnerable to the edicts of pagan emperors and persecution by any who disagreed with them. Paul, aware of these realities, counsels believers to avoid trouble by refusing to retaliate when persecuted and to respond with good when they are treated with evil.

Douglas Moo: As we noted at the outset, the commands in **verses 9–21** do not follow any strict logical order. In keeping with the style he uses, Paul moves rapidly from one subject to another. But we can discern a single underlying concern in **verses 14–16: the need to live in harmony with other people**, both unbelievers (**v. 14**) and believers (**vv. 15–16**). We pursue this goal with unbelievers by meeting their scorn and hatred with love; we display the deep-seated harmony that the Spirit creates among believers by making other believers’ joys and sorrows our own.

Steven Cole: **vv. 14-16** -- There is another connection between these three seemingly disjointed verses: they all are **rooted in selflessness or self-denial**. We can only bless our persecutors and not curse them if we are more concerned about their eternal welfare than we are about our suffering. We can only rejoice with those who rejoice and weep with those who weep if our focus is off ourselves and on their situation. We can only be of the same mind with one another and not be haughty or wise in our own estimation if our eyes are on the Lord and others, not on ourselves. Selflessness is the thread that ties all three verses together.

**I. (:14) BLESS THEM –
DETERMINE TO BRING YOUR ENEMY GOOD NOT HARM**

“Bless those who persecute you; bless and curse not.”

Frank Thielman: The participial expression “*those who persecute*” (τοὺς διώκοντας) echoes the participle “*pursue*” (διώκοντες) at the end of the previous sentence. Now, however, the tables are turned, and Paul depicts believers as the object of hostile pursuit. In such a situation, he says, believers should respond in a **radically unnatural way** and wish their persecutors well

with kind words rather than wishing their destruction with words of abuse. As the quotation of **Proverbs 25:21–22** in **Romans 12:20** shows, this approach to those who actively seek one's harm arises from the OT (**Exod 23:4–5**; **Job 31:29–30**; **Prov 24:17–18**), probably as it was reformulated in the teaching of Jesus (**Matt 5:43–48**; **Luke 6:27–29, 31–35**). Paul acted on this principle himself (**Acts 16:25–33**; **1 Cor 4:13**), and it was a consistent feature of his ethical teaching (**1 Thess 5:15**).

Thomas Schreiner: the injunction to bless those who persecute us is one of the most revolutionary statements in the NT and can be carried out only by the power of the Holy Spirit.

Michael Bird: As to what kind of **persecution** the Roman Christians may have been experiencing at this point, before the Neronian persecution, it is hard to say. It could have included a mixture of social ostracism, slander, boycott of business, and legal action. If the epistle to the Hebrews has a Roman provenance, the believers may have experienced the various hardships described therein, including public insult, imprisonment, and confiscation of property (see **Heb 10:32 – 34**). Such things may have happened to them when they came to faith and during the expulsion occasioned by the Edict of Claudius.

Steven Cole: Regarding the **imprecatory psalms**, it is important to realize that they were judicial and national, rather than personal cries for vengeance. On a personal level, David often refrained from taking vengeance on his enemies. But as the king over God's people, David was crying out for God to bring justice on evildoers. Also, they reflect the fact that one day Christ will bring judgment on all who do not repent. When we pray for God's kingdom to come, we are praying that He will either save or judge the wicked. So an appropriate prayer for those who have persecuted us may be, "Lord, would You please save him, but if not, I know that You will judge him righteously." The transformed attitude that we are to reflect is: because God was merciful to me while I was His enemy, I need to bless those who have treated me wrongfully.

II. (:15) EMPATHIZE WITH THEM – SHOW CONCERN FOR YOUR ENEMY'S GAINS AND LOSSES

"Rejoice with those who rejoice, and weep with those who weep."

Frank Thielman: Believers should not be self-absorbed but empathetic with the joys and sorrows of others. . . . Paul was perhaps already thinking of the unity and humility that he would advocate in the next sentence. To share in the joy and sadness of others requires regarding their circumstances as more urgently in need of attention than one's own circumstances and seeing others as more important than one's self (cf. **1 Cor 12:26**).

Thomas Schreiner: Rejoicing with those who are rejoicing and weeping with those who are weeping are **concrete indications of love** in the Christian church. **Oakes** (2009: 120) is probably right in suggesting that the social elite would not typically join in with the sorrows and joys of slaves, and thus the family character of the church again emerges. **John Chrysostom** (Homilies on Romans 7 [on **Rom. 3:31**]; [on **Rom. 12:15**]) may well be right in remarking that the admonition to rejoice with those who rejoice occurs first because it is more difficult. We are all inclined to shed a sympathizing tear with those who are suffering (cf. **Sir. 7:34**), but envy and a

sense of competition often hinder us from truly rejoicing with those who rejoice.

Grant Osborne: Following Jesus will mean that believers will pass through a kaleidoscope of experiences in life. Christianity is neither denying life's hardships, or dulling life's excitements. Our perspective of eternity in Christ can free us to enter into the full variety of living. Both laughter and tears are appropriate before God. Each has an important place in representing our feelings. Identifying with the joys and heartaches of others is also an important way to show them our love.

III. (:16) SHOW HUMILITY – DO NOT ALLOW YOURSELF TO THINK YOU ARE BETTER

*“Be of the same mind toward one another;
do not be haughty in mind, but associate with the lowly.
Do not be wise in your own estimation.”*

Michael Bird: The focus is not on uniformity in thought, but on a single-minded pursuit of harmonious relations. They are to be thoughtful for how they treat each other.

Thomas Schreiner: The redeemed community should be marked by humble concern for one another, and all should be treated as valued persons made in the image of God and redeemed by him.

Michael Gorman: The practice of **associating with the lowly** is grounded in the reality that “*God chose what is foolish in the world to shame the wise; God chose what is weak in the world to shame the strong; God chose what is low and despised in the world, things that are not, to reduce to nothing things that are, so that no one might boast in the presence of God*” (1 Cor 1:27–29). This divine preference for the weak is grounded still further in the reality that the weakness of Christ crucified is the power of God (1 Cor 1:18–25).

Grant Osborne: Many people use their contacts and relationships for selfish ambition. They select those people who will help them climb the social ladder. Christ demonstrated and taught that we should treat all people with respect—those of a different race, the handicapped, the poor, young and old, male and female. We must never consider others as being beneath ourselves. Are we willing to befriend newcomers and entry-level people? Or do we relate only to those who will help us get ahead?

IV. (:17) AVOID RETALIATION – DO NOT ALLOW ANOTHER'S EVIL TO DETERMINE YOUR RESPONSE

“Never pay back evil for evil to anyone. Respect what is right in the sight of all men.”

Thomas Schreiner: The desire to **retaliate** almost overwhelms us when we have been treated unjustly. **Oakes** (2009: 123–26) says it was quite common for the injustice to be physical violence of some sort, and then the temptation to round up one's own group and inflict the same on the perpetrator would be significant. Perhaps the difficulty of resisting revenge provoked Paul

to add the word ἀγαπητοί (*agapētoi*, *beloved*) here. Even though believers are severely mistreated by others, they should never forget that they are dearly loved by God and chosen to be his own. Rejection by others is a deep wound, but the salve of God's love for us is the best healing for it. . .

The second command in **verse 17** should probably be related to the command to **avoid retaliation**. Thus when Paul says, "*Think beforehand what is good in the sight of all people,*" his point is that all people, even unbelievers, recognize that refraining from getting even is good.

V. (:18) MAINTAIN PEACE – ALWAYS TRY TO MAINTAIN AN ATMOSPHERE OF PEACE

"If possible, so far as it depends on you, be at peace with all men."

Frank Thielman: The caveat that believers should do this "*if possible*" and "*to the extent that it is up to you*" recognizes that some people refuse to live at peace with others until everyone under their power has become complicit in their wickedness. In this situation, Paul implies, the believer must forgo peace and remain faithful to the "*good and pleasing and perfect*" will of God (**12:2**).

Thomas Schreiner: One of the marks of Christians is a winsome and friendly spirit that delights in peace and harmony, not arguments and division. Nonetheless, Paul recognizes that the goal of peace with all people cannot be realized perfectly.

VI. (:19) LEAVE VENGEANCE TO GOD – LET GOD "WORRY" ABOUT REPAYING EVIL

"Never take your own revenge, beloved, but leave room for the wrath of God, for it is written, 'Vengeance is Mine, I will repay,' says the Lord."

Thomas Schreiner: This text suggests that believers will not be able to conquer feelings of **revenge** unless we recognize that God will eventually set all accounts right. We would fall prey to retaliation in the present if we did not know that God would vindicate us in the future. Thus the recognition that God will judge our enemies is crucial for overcoming evil with good. Believers can leave the fate of their persecutors in God's hands, knowing that he is good and just and that he does all things well. Believers are also to pray that God will bless those who persecute them (**Rom. 12:14**). This means that we pray for the salvation of our oppressors, hoping that they will turn from their evil and be rescued from the wrath to come. Nonetheless, we need to know (cf. **2 Thess. 1:3–10** for the same theme) that those who do not repent will experience judgment.

VII. (:20) MEET PRACTICAL NEEDS – GIVE YOUR ENEMY WHAT HE NEEDS NOT WHAT HE DESERVES

"But if your enemy is hungry, feed him, and if he is thirsty, give him a drink; for in so doing you will heap burning coals upon his head."

Frank Thielman: It may be best to admit that we do not know precisely what the imagery means. Paul's basic point, however, is clear, and **Lagrange** has described it succinctly: “ ‘*To have burning coals on the head*’ constitutes a most painful situation, and a situation that is easy to exit, if one wants to. The idea is that the enemy would feel defeated by such generosity and disposed to better sentiments.”

Michael Bird: By showing unexpected and undeserved kindness we can make our opponents become friends and break down hatred, prejudice, and ignorance. However, for those who do not change, who wish to continue their hatred for hatred's sake, such kindness does have a negative impact. A brutish response to kindness demonstrates their fitness for divine recompense and is tantamount to piling coals of fire on their head, symbols for God's coming in judgment (see **Pss 18:8, 12; 120:4; 140:10**).

Thomas Schreiner: Paul's point is that the actions of believers serve as the basis for God heaping coals on unbelievers. To put it another way, through their actions believers become the means of **God's punishment**.

Most scholars today reject this view, asking How can one do good to others if one's ultimate motivation is that God will heap coals of fire on them in the eschaton? The difficulties of this interpretation are exaggerated by most scholars because the reference to God's judgment here parallels the promise of God's vengeance in **verse 19** (so **Piper** 1979: 116; **Day** 2003). Indeed, that **verses 19–20 are parallel** strengthens the case for “*coals of fire*” being a reference to God's judgment. Just as readers are to refrain from revenge because God will judge (v. **19**), so too they are to do good because he will punish their enemies (v. **20**). **Dunn** (1988b: 751; cf. **Byrne** 1996: 384) says that ἀλλά indicates that **verse 20** stands in contrast to **verse 19** so that God's judgment cannot be in view in both cases. But he misses the point of the contrast. **The contrast between the two verses is found in the actions of believers, not in the judgment of God.** In **verse 19** believers are commanded not to take vengeance, but in **verse 20** they are now commanded to do good. Yet is it not psychologically improbable that the promise of God's judgment would free believers to do good to their opponents? Not any more improbable than the argument found in **verse 19**, where God's future vengeance frees believers from taking revenge on their enemies. In both cases, **believers are liberated from taking justice into their own hands** and are free to do good because they know that in the end God will right all wrongs. Those who continue to resist repentance must experience God's wrath, for otherwise God cannot remain faithful to his name (cf. **Piper** 1979: 117–18). Similarly, Jesus could refrain from cursing his adversaries because he entrusted himself to God, “*who judges righteously*” (**1 Pet. 2:23**). The sure realization that God will vindicate us frees us to love others and to do good to them, and even to pray that God will bless them (**Rom. 12:14**) and bring them to repentance. Believers will not chafe at any oppressor being brought to repentance, because they trust the goodness and justice of God, knowing that he does all things well and that they themselves were deserving of wrath (**1:18 – 3:20**).

(:21) SUMMARY – OVERCOME EVIL WITH GOOD

“*Do not be overcome by evil, but overcome evil with good.*”

Thomas Schreiner: Believers should not let the evil they experience at the hands of others master them so that they fall prey to evil themselves (v. **21a**). They are called on to surmount every evil by doing good, and what gives them the courage and strength to do so is the belief that God is a righteous judge who will set straight every wrong that is done.

Douglas Moo: Though redeemed and citizens of heaven, we believers still live in a world soaked in evil. We must battle constantly against the tendency to conform our behavior to this world (see **12:2**). But more than the purely negative quality of resistance to evil is needed. God calls us to be active in using the grace of the gospel and the power of the Spirit to win victories over the evil of this world.

* * * * *

DEVOTIONAL QUESTIONS:

- 1) How has Christ **transformed your attitudes** to respond to other people in ways that the world would find unnatural?
- 2) Do these verses promote a view of **pacifism** (whether individual or national) or not? Why or why not?
- 3) How can you grow in the area of **selflessness** and **self-denial**?
- 4) Has the Holy Spirit restrained your temptation to lash out in **retaliation** or to seek **revenge** when personally wronged?

* * * * *

QUOTES FOR REFLECTION:

Douglas Moo: THE STYLE OF PARAENESIS.

A passage such as **12:9–21** carries a strong temptation for the modern Western commentator. We tend to be quite enamored of our abilities to find **structure** and **movement** in the biblical text—that is, to point out to our readers relationships that they may never have seen. How tempting it is, then, **to seek structure where it doesn't exist**. Indeed, we sometimes think it is beneath the New Testament writers to write without careful structure.

But the temptation to impose structure on a text is not limited to commentators. In teaching biblical texts over the years, I have seen the same assumption that a biblical text must be carefully and logical organized operating among laypeople. I think, however, that this assumption must be challenged. We seem to assume that the special inspired quality of Scripture demands that it always be logically organized. If God is organized and he inspired every text of the Bible, must not those texts likewise be organized?

Of course, a lot depends on what we mean by organized. Every biblical text is **deliberate**, in the sense that it was written with a **particular purpose**; and it is **logical**, in that, when we rightly

interpret it, it makes sense. But not all biblical texts are organized in the kind of neat, logical arrangement we can display in an outline. In fact, I suspect that our tendency to use traditional outlining schemes (A., A.1., A.1.a., etc.) in summarizing biblical texts is a large part of the problem. We are not quite sure how to take a “bird’s-eye” view of a text if we do not impose an outline on it. But communication is much broader than those types that are susceptible of being summarized in such an outline, and such types of communication are no less effective in accomplishing their purposes.

In **12:9–21**, Paul writes in an ancient style called **paraenesis**. Scholars debate about whether we should call paraenesis a style or a genre and how sharply defined it was. But almost everyone agrees that such a style existed and is found widely in the ancient world.

Paraenesis has three main characteristics.

- (1) It was usually used for **moral exhortation**—to urge people to adopt certain attitudes or behaviors.
- (2) It usually depended heavily on **tradition**. That is, the writer freely borrowed from many sources. Recognizing such allusions, the readers or listeners accorded greater authority to the paraenesis, since they incorporated elements these people already respected.
- (3) It was **loosely structured**. The writer or speaker deliberately moved quickly from one topic to another without attempting to pursue a definite line of development.

The letter of James is often thought to display a paraenetic style, as are specific parts of other New Testament letters.

Romans 12:9–21 obviously fits the parameters of paraenesis we have just sketched. In no obvious order of logical sequence, Paul exhorts Christians to adopt certain attitudes and forms of behavior, freely citing the Old Testament, Jewish tradition, and the teachings of Jesus to communicate his points.

One of the mistakes we make in looking at possible backgrounds to the New Testament is to assume, as one scholar has put it, that ideas in the ancient world flowed in **pipelines**. That is, we wrongly expect that a given teaching always remained in a pure and unadulterated form, unaffected by other teachings. Of course, we all understand that the world is not like that. **Ideas jostle with each other**, and rarely do we encounter one in complete isolation from others like it. So it is also with literary genres and styles. Paul uses the paraenetic style popular in the Greco-Roman world as he writes these verses. But he is also influenced by the Old Testament and Jewish wisdom style that we find, for instance, in Proverbs. The two styles—and perhaps others we have not considered—have merged to some extent, and Paul probably could not have identified just what parts of **12:9–21** come from one and what parts from the other.

For our purposes, however, the important point is that Paul writes in a style well known in the ancient world, which was **effective** in communicating what he wanted to get across to his readers. We need to respect the style he has used and not try to impose on the verses modern assumptions about “correct” structure or logical organization. The style he has chosen to use keeps us on our toes. The commands come rapidly, one after the other, and we have no way of predicting what is going to come next. The very changes of topic that perplex us at one level force us to grapple with each exhortation in its own right.

We are, of course, supposed to think about what Paul is saying. But he is more interested in getting us to react. The rapid-fire style of the text is effective in accomplishing this. If the medium is not entirely the message, as **Marshall McLuhan** would have us believe, it is vitally related to the message. Paul has arguably chosen here to use a medium that suits what he wants us to hear better than a logical style of arguing would have done.

Michael Bird: Love Must Be Sincere

The key characteristics of love in **Romans 12:9-10** are that it must be authentic and outward looking. An authentic love is one without pretense and hypocrisy. There is no pretending to love someone and no harboring hate underneath a thinly veiled smile of friendship. Those who love must empty out what is hypocritical and hateful in their hearts and cling to everything that is noble and kind. The Danish philosopher **Søren Kierkegaard** put it the best: “The best defense against hypocrisy is love; indeed, it is not only a defense but a chasmic abyss; in all eternity it has nothing to do with hypocrisy. This is also a fruit by which love is known — it secures the loving one against falling into the snare of the hypocrite.”

To work this out in practice, Christians must live lives of sacred love. If Christians hold to Jesus’ creed about loving God and loving others, and if we apply this creed as Paul does here, then several praxes will become discernible in our church community. According to **Scot McKnight**, the Jesus creed of sacred love transforms our lives in several ways.

- First, it will transform our speech so that we talk with charity and reserve. It is okay to speak one’s mind as long as one speaks with the mind of Christ.
- Second, sacred love converts our actions so that what we do to others is determined principally by what we can do for them. It comes down to a simple golden rule of treating others how you would want to be treated.
- Third, sacred love inspires our worship as it forces us to realize that we are sinners and God is merciful. When we comprehend how God’s love reaches those who were loveless toward him, we are ready to kneel before him in humility and to sing to him in praise.

When it comes to loving sincerely and loving outwardly, it all comes down to creating an agape culture in our churches where people are consumed with love and our churches are known by their love. We need to cultivate a theology and practice that lead to an inward love for each other and an external love for others because we love God. To quote **Kierkegaard** again: “The last, most blessed, the unconditionally convincing mark of love remains — love itself, the love that becomes known and recognized by the love in another. Like is known by like; only someone who abides in love can know love, and in the same way his love is to be known.”

Michael Gorman: To sum up: practicing peace and doing good rather than engaging in evil and retaliation are grounded in several realities:

- scriptural teaching;
- Jesus’ own teaching and example;
- God’s love for enemies manifested in Jesus’ death;
- the certainty of divine judgment for the unrepentant; and
- the hope of prompting enemies to change their hearts, minds, and lives.

James Dunn: The fact that vv 15–16 seem to focus attention back once again more on the **internal relationships** of the Christian congregations should not be seen merely as a disruption of the wider concern. On the contrary, these verses should be taken as some indication of the degree to which Paul saw the life of the Christian churches as **integrated into the wider life in the city**. The call for sensitive sympathy with those caught in the ups and downs of daily life (v 15), for a proper modesty of self-esteem and for a genuine solidarity with the most lowly ranked or disadvantaged within the congregation (v 16) is of a piece with the positive will to bless the persecutor (v 14) and to do good to the malicious and spiteful (v 17). Paul did not see a Christian's life as divided neatly into two sets of attitudes and obligations—one to fellow believers, the other to nonbelievers. The same sympathetic concern and positive outgoing love should be the rule in all cases—a love which does not reckon or depend on receiving a positive response in turn. For this not only Jesus' words but Jesus' example provided the model which would be not far from the surface of Paul's mind (here too the same sequence of thought as in 5:1–11 and 8:18–39 probably reflects a regular pattern in Paul's theology).

Also significant is the extent to which Paul takes for granted actual contact of his listeners with the wider city community, and awareness of the moral standards prized by others: they must live at peace (v 18) and seek to have as positive relations with their unbelieving neighbors and associates as possible; they must be mindful of what others value and hold in high regard and be sure not to let their ethical and aesthetic standards leave them open to the criticisms of Stoic or Cynic (v 17); they should be known for their wholehearted committal to oneness with the deprived (v 16), they should show hospitality to enemy as well as fellow believer (v 20), and their relationships within the wider community could result in persecution (vv 14, 17, 19–21). All in all Paul has no thought of the Roman Christians as **compartmentalizing their lives** (into spiritual and ordinary affairs) or of living their lives cut off from contact with the wider community. He takes it for granted that Christians will live out their daily lives and wider relationships motivated by the same love as in their relationships with fellow believers.

John Toews: Do Not Repay Evil but Overcome Evil with Good 12:17-21

The text unit has one theme—**actively reject retribution in any form**. The theme is stated three times, at the beginning, in the middle, and at the end:

- 1) repay no one evil for evil (v. 17),
- 2) never avenge yourselves (v. 19),
- 3) do not be overcome by evil, but overcome evil with good (v. 21).

Paul rejects the moral code of the ancient world which justified paying back harm done to oneself or to loved ones (the *lex talionis*).

Paul exhorts more than rejection of retribution. He also counsels behavior that assumes a **new world view** or a new set of values:

- 1) take thought for what is noble in the sight of all people (v. 17),
- 2) if you are capable, live peaceably with all people (v. 18),
- 3) if your enemy is hungry, feed him, if he is thirsty, give him drink (v. 20),
- 4) overcome evil with good (v. 21).

The first counteraction picks up the idea of right thinking, literally, thinking beforehand. Instead of retaliation give forethought to behavior that is beautiful and good before all people

and act on the basis of these values.

The second counteraction picks up the peacemaking theme of Jesus (**Matthew 5:9**), actively engage in peacemaking or be a peacemaker. The qualification if you are capable (lit., *if you have the power*) recognizes that peaceful living takes two sides. In a context of oppression and persecution it may not be possible, or it may not lie within your power, to live peaceably. The verbal form (*eireneuontes*) requires the supplying of a helping word in English, living, pursuing, building, and so forth. Making peace a verb, not available in English, connotes a dynamic element often missed in current discussions on peace.

The third counteraction is a quote from **Proverbs 25:21-22**. Do not respond to hostility only with passivity—leaving it to God—but with **concrete acts of kindness**. . . Responding to evil with hospitality and kindness has a positive effect; it unsettles the enemy. The final counteraction uses the imagery of a Christian standing in the middle of a battle with the evil of the present age. Do not respond to the power of evil by using the means of evil, hostility or retaliation, but with the power of good.

The theological reason for the exhortation is given in the middle, **leave it to the wrath of God (v. 19)**, supported by a word of Scripture, *vengeance is mine, I will repay, says the Lord (Deut. 32:35)*. The people of God are not to retaliate for evil done to them, because **judgment is God's business**. Retaliation against the enemies of God's people was both advocated and practiced by the Jewish Zealots in Paul's day. The Zealot option may well have been a factor among Roman Jews and Jewish Christians. Paul, in agreement with a series of Jewish teachers (T Gad 6:7; 1QS 10:17-18; CD 9:2-5; 2 En.50:4), rejects revenge against opponents whether outside or inside the boundaries of God's people, because such action must be left to God.

Bob Deffinbaugh: Four reasons from these verses that it is always wrong to take your own revenge.

(1) **Revenge runs contrary to what society deems to be right.** Note verse **17b**: “*Respect what is right in the sight of all men.*” Our laws prohibit **vigilante justice**, where one person takes it upon himself to right some perceived wrong. And, while we sometimes chuckle at the absurd extremes that people take to get revenge, at least our culture usually knows that their behavior is wrong. The world generally knows that revenge solves nothing.

(2) **Revenge does not promote peace but incites men to hostility.** In verse **18**, Paul says, “*If possible, so far as it depends on you, be at peace with all men.*” Vengeance doesn't lead to peace, but to further vengeance. It keeps the vicious cycle going.

(3) **Revenge usurps a task which belongs only to God.** In verse **19**, Paul says, “*Leave room for the wrath of God, for it is written, 'Vengeance is Mine, I will repay,' says the Lord.*” We are incompetent to carry out personal vengeance, because we cannot know all of the motives and circumstances that were behind a person's wrongful action towards us. Besides, our emotions get involved and cloud our judgment. Only God, who knows all things, is a competent and righteous Judge.

(4) **Revenge succumbs to evil rather than overcoming evil with good.** As Paul commands (12:21), “Do not be overcome by evil, but overcome evil with good.” To take revenge is to respond to sin with more sin. It puts you on the same level as the one who sinned against you.

Leedy Greek NT Diagrams:

Rom 12:14

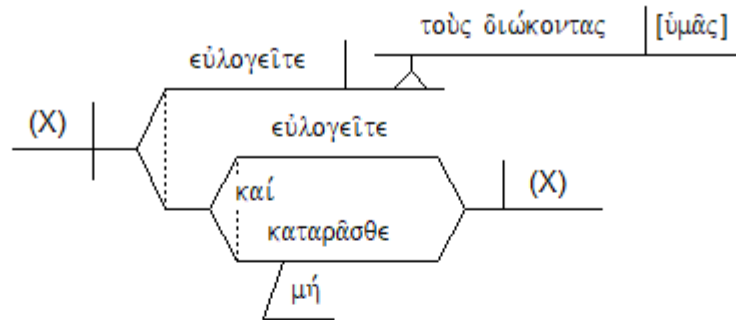

Rom 12:15

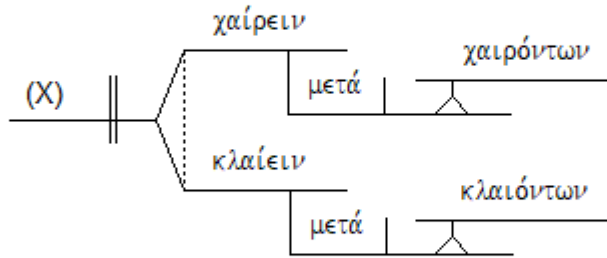

Rom 12:16

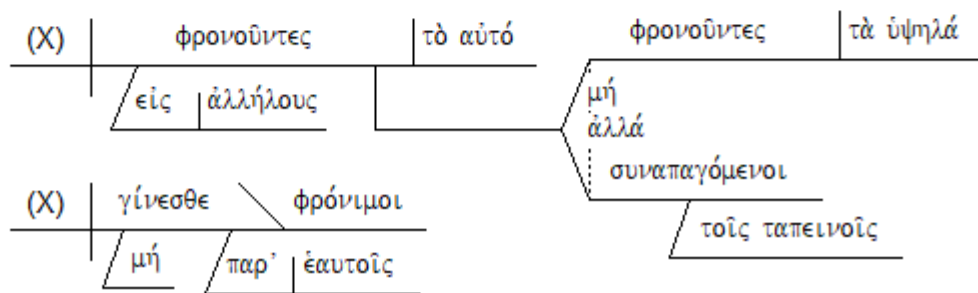

Rom 12:17-19

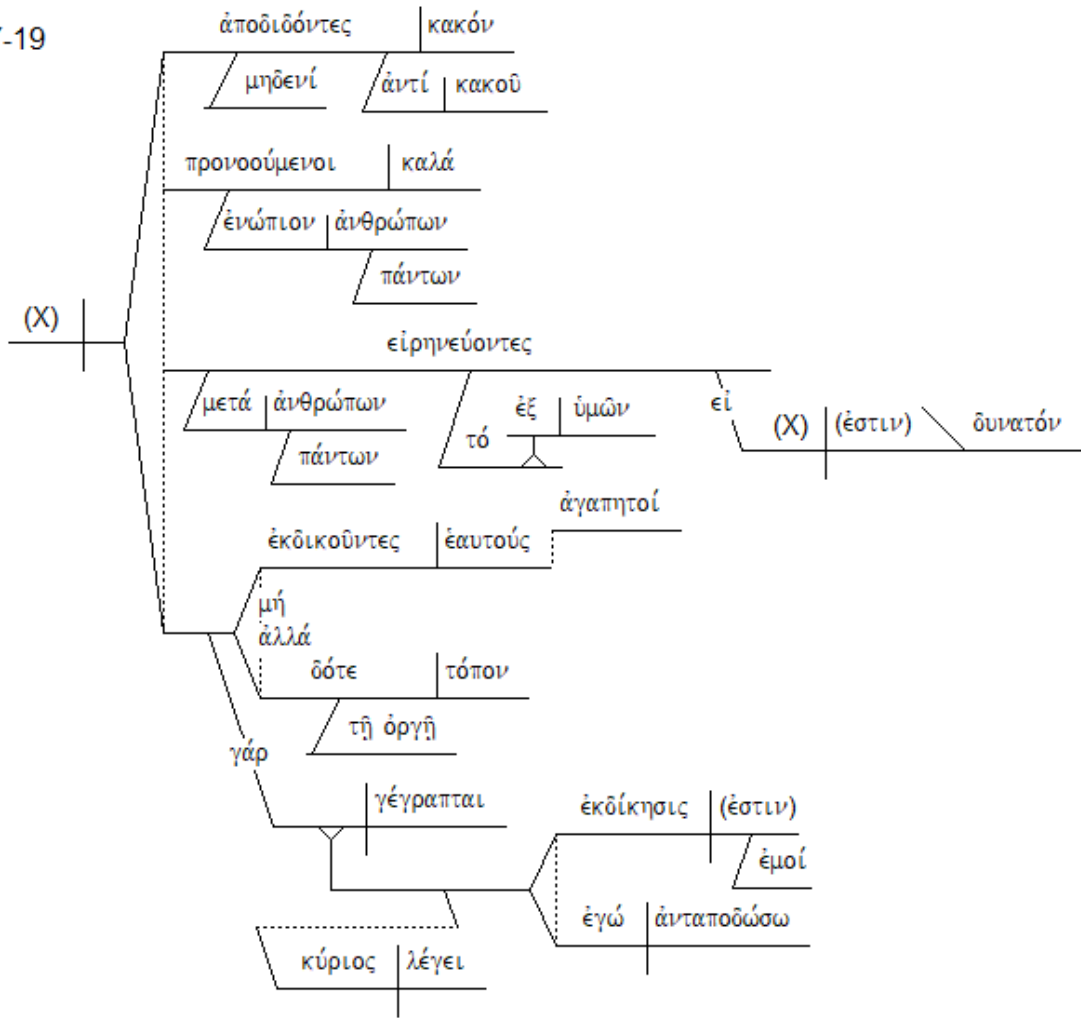

Rom 12:20

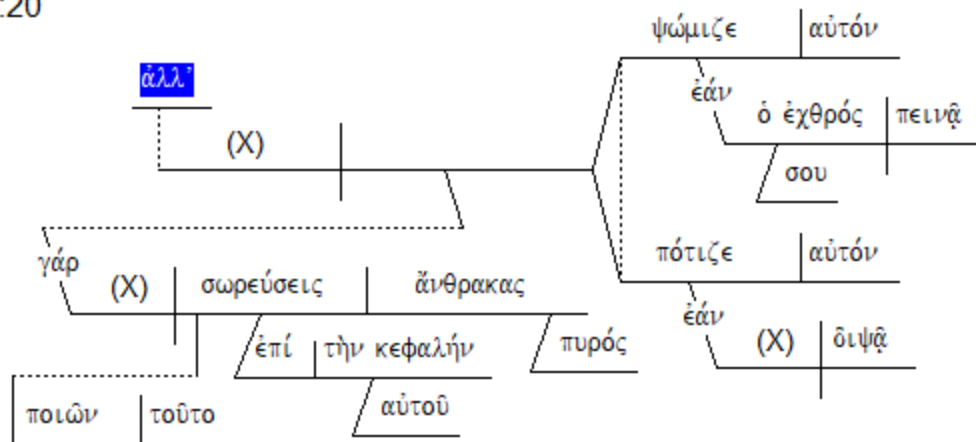

Rom 12:21

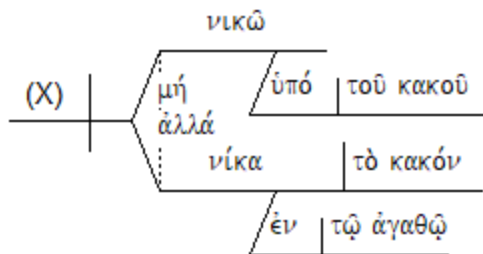

Frank Thielman:

- 14a Exhortation **Bless** those who persecute;
- b Exhortation **bless and do not curse.**
- 15a Exhortation **Rejoice** with those who rejoice;
- b Exhortation **weep** with those who weep.
- 16a Exhortation **Think the same way** toward one another;
- b Exhortation **do not think haughty thoughts,**
- c Exhortation (contrast) **but be carried away with humble concerns.**
- d Exhortation **Do not be wise in your own estimation.**
- 17a Exhortation **Repay no one evil for evil;**
- b Exhortation **take into consideration what is good in the sight of all human beings.**
- 18a Condition If possible, to the extent that it is up to you,
b Exhortation **live at peace with all human beings.**
- 19a Exhortation **Do not give out justice yourselves,** beloved,
- b Exhortation (contrast) **but give place to God's wrath,**
- c Basis (for 19a–b) for it is written,
 "‘It is for me to give out justice, I will repay,’ says the Lord.” (Deut 32:35)
- 20a Exhortation But,
 “if your enemy is hungry,
 give him something to eat;
b Exhortation if he is thirsty,
 given him something to drink.
- c Basis (for 20a–b) For, if you do this,
 you will pile fiery coals on his head.” (Prov 25:21–22)
- 21a Exhortation **Do not be conquered** by evil,
- b Exhortation (contrast) **but conquer evil** by good.

TEXT: ROMANS 13:1-7

TITLE: SUBMISSION TO DIVINELY APPOINTED CIVIL AUTHORITY

BIG IDEA:

WE ARE TO SERVE GOD BY SUBMITTING TO CIVIL GOVERNMENT WHICH USES ITS DELEGATED POWER TO PROMOTE GOOD AND RESTRAIN EVIL

INTRODUCTION:

Michael Bird: Government is a form of **common grace** instituted by God where God uses human rulers to provide justice, order, and civility for the peoples governed. As **Moo** comments: “Government is more than a nuisance to be put up with; it is an institution established by God to accomplish some of his purposes on earth.” Thus, Paul acquiesces to political submission for the sake of respecting God’s appointed servants who genuinely benefit its citizens with the exercise of their authority.

Douglas Moo: From the beginning of the church the radical demands of the gospel to avoid conformity to this world were taken too far by some overly enthusiastic believers. They thought that the coming of the new age meant that everything in the world was under judgment and to be avoided by truly “spiritual” Christians. They included in “the world” such institutions as **marriage** (see **1 Cor. 7; 1 Tim. 4:3**), **sex** (**1 Cor. 7** again), and the **government** (see, e.g., **1 Tim. 2:2; Titus 3:1; 1 Peter 2:13–14**).

Thus, the apostles had to combat this kind of **extremism**, pointing out that such activities were, in fact, appointed by God for the good of human beings. Christians should not think their faith requires them to consider these institutions as evil. This helps us understand why Paul felt it necessary to **balance his demand** that believers not “*conform [to] this world*” (**12:2**) with a reminder that governmental authorities were not of the world in this sense, but were, in fact, servants of God, doing his will.

Juliany Gonzalez Nieves: We are not called to blind submission, but to what I have called **subversive submission**. We are **dual-citizens** of our country and of the Kingdom of Heaven. We honor God and those around us by submitting to authority and cultivating an environment conducive to human flourishing. However, when there is a clash of kingdoms, we are called to be faithful first and foremost to the Kingdom of Heaven and its King

Grant Osborne: Paul urges believers to be careful in their relationships with the governing authorities. There would come enough persecution without them bringing it on themselves by rebelling against authorities who could just as well serve them.

In addition, modern-day readers must take special note of what life in the Roman empire was like. The political powers were there by birth, connection, wealth, or ruthlessness. The masses had no power, could never expect to have any power, and could never think that they could change the status quo. Their best strategy was to live within the structure and take advantage of the protection offered by it. Because people still believed in “the divine right of kings,” most

authority went unquestioned. And those in authority usually had a well-developed system of spies and informers who would not hesitate, in the name of good citizenship, to turn in anyone who complained or rebelled. It may be difficult for us to understand the political realities in ancient Rome, but the mind-set of the times caused Paul to exhort believers to be careful. Christians were not to rebel against godless Rome—Roman law was the only restraint against the lawless.

R. Kent Hughes: Thus far Paul has shown us that we are called to a profound, intelligent obedience to government (vv. 1, 2) and that government is meant to serve us and do us good (vv. 3, 4). Now in verses 5–7 he describes the **kind of obedience** to which we are called. . .

In conclusion, it is the Christian’s duty to obey those in political authority because:

- 1) government is divinely appointed,
- 2) it is a deacon to meet our needs, and
- 3) we see it for what it is.

Steven Cole: The Government and You

- First (13:1) Paul states that every person is to be subject to the governing authorities, because God is the sovereign who ordains all human governments.
- Then (13:2) he draws the implication: If you resist government authority, which God has established, you are opposing God Himself and you’ll come under judgment.
- Then (13:3-4) Paul explains that the purpose of civil government is to protect law-abiding citizens and punish law-breakers. As such, the government is acting as a minister of God in avenging wrong.
- Thus (13:5) there are two reasons to be in subjection to the government:
 - o Fear of punishment and
 - o conscience before God, who has ordained the government.
- Finally (13:6-7), Paul applies it by showing why we should pay taxes, namely, because government officials are servants of God. Thus they deserve our taxes as well as our respect.

I. (:1-2) POWER OF CIVIL AUTHORITY REQUIRES SUBMISSION

A. (:1a) Power that Demands Submission

“Let every person be in subjection to the governing authorities.”

Frank Thielman: The term “*authority*” (ἐξουσία) was a natural term to use for an “office” or “magistracy” that carried with it the exercise of political or judicial power (e.g., **Dan 7:27 LXX**). . . Here, as the talk of submission and payment of taxes shows (**Rom 13:5–7**), he has in mind the earthly magistrates who presided over the Roman system of justice.

Douglas Moo: First, “*governing authorities*,” as the translation suggests, refers to any person who represents the power of the state: from the local bureaucrat right up to the emperor, president, or prime minister. . .

The second key word is “submit” (*hypotasso*). What is important to understand is that this word is broader in its scope than “obey.” It calls on believers to recognize that they “stand under” government in the scheme that God has instituted for ruling the world.

Bruce Hurt: Believers then (when Rome ruled with an iron fist) and now might be tempted to feel that since we are “*aliens and strangers*” (1Pe 2:11) in this present world and are citizens of the Kingdom of God, we do not need to submit to wicked rulers. We are citizens of heaven, journeying through time on earth. So although heaven is our home, Spirit filled (controlled) believers must be subject to authorities.. Why? Paul says because that authority is established by God. . .

Hypotasso focuses on function, not essence. In non-military use, it was “a voluntary attitude of giving in, cooperating, assuming responsibility, and carrying a burden”. The central idea is to be under the authority of some authority.

Stated another way submission means to voluntarily follow the direction of those in authority over you. **Submission** is not the same as **obedience**, though the two are related. Obedience relates to outward performance, while submission touches the **attitude of the heart** toward those who are over you. This distinction is critical because you may not always be able to obey those who are over you, but you can always have a heart attitude of submission.

Submission is believing that God is able to accomplish His will in your life through those He has placed in authority over you. This definition focuses the attention on God, not on the person over you.

B. (:1b) Power that Is Delegated from God

*“For there is no authority except from God,
and those which exist are established by God.”*

C. (:2) Power that Is Directed against All Resistance and Opposition

1. Resisting Authority = Opposing God

“Therefore he who resists authority has opposed the ordinance of God;”

2. Opposing Authority Brings Harmful Judgment

“and they who have opposed will receive condemnation upon themselves.”

II. (:3-5) PURPOSE OF CIVIL AUTHORITY REQUIRES SUBMISSION

A. (:3-4) External Motivation to Submit = Avoidance of Wrath

1. (:3-4a) Civil Authority Benefits Those Who Do Good

*“For rulers are not a cause of fear for good behavior, but for evil.
Do you want to have no fear of authority? Do what is good, and you will have
praise from the same; 4 for it is a minister of God to you for good.”*

Steven Cole: the government must **legislate morality**. You often hear that we should not legislate morality, but that is absurd. . . If God’s purpose for civil governments is to protect

law-abiding citizens and punish law-breakers, then it follows that we should use civil authorities for **protection** and **due process**. Paul himself did this in Philippi, where he was unjustly beaten and imprisoned without a trial, although he was a Roman citizen. When the authorities realized their error and wanted to quietly usher him out of town, Paul wouldn't stand for it (**Acts 16:35-40**). He also invoked his Roman citizenship to avoid a scourging and to appeal to Caesar rather than face a kangaroo court (**Acts 22:25; 25:11**).

2. (:4b) Civil Authority Punishes Those Who Do Evil

*“But if you do what is evil, be afraid;
for it does not bear the sword for nothing;
for it is a minister of God,
an avenger who brings wrath upon the one who practices evil.”*

Frank Thielman: Paul's audience should voluntarily submit to the government not because of any intrinsic worth that the authorities themselves possessed but because God used them to provide social order, and this social order was a good thing that God desired (cf. **Rom 13:3-4**).

Thomas Schreiner: The reference instead is to the broader judicial function of the state, particularly its right to deprive of life those who had committed crimes worthy of death, though fines, arrest, imprisonment, other corporal punishment, and exile are also included (see **Schnabel 2016: 686**). Paul would not have flinched in endorsing the right of ruling authorities to practice capital punishment, since **Gen. 9:6** supports it by appealing to the fact that human beings are made in God's image. Precisely because human beings are so valuable as God's image bearers, it follows that one who intentionally takes the life of another should also be deprived of life. Governing authorities are to mete out wrath to vindicate justice (ἐκδικος εἰς ὀργήν τῷ τὸ κακὸν πρᾶσσοντι, *ekdikos eis orgēn tō to kakon prassonti*, an **avenger for wrath** to the one practicing evil) in the case of the one who flouts the law and does what is evil.

Steven Cole: My understanding is that capital punishment is still fitting for first degree murder. It upholds the sanctity of human life to impose the penalty of life for life. But the way that our government practices capital punishment is **inept**. Murderers are allowed to live on death row for decades while they file appeal after appeal, often on technicalities. My view is that if a criminal is guilty beyond a shadow of a doubt, he should be executed immediately after his trial. **Ecclesiastes 8:11** states, “*Because the sentence against an evil deed is not executed quickly, therefore the hearts of the sons of men among them are given fully to do evil.*” To argue that a criminal should not be executed because he is insane is insane. To insist that we must execute him as painlessly as possible is insane. The issue is that he ruthlessly murdered innocent people. The punishment for that crime should be quick, painful death. Anything else cheapens the lives that he slaughtered.

B. (:5) Internal Motivation to Submit = Consciousness of God's Will

*“Wherefore it is necessary to be in subjection, not only because of wrath,
but also for conscience' sake.*

Thomas Schreiner: When Paul says that one must be subject “*because of wrath*” (διὰ τὴν ὀργήν, *dia tēn orgēn*), the wrath is identical with the wrath that the government exercises in **verse 4**, and

Paul exhorts believers to submit to the government because of “*wrath*” and “*conscience*.” The term “*wrath*” hooks up with **verses 3–4**, where Paul calls on believers to submit to avoid the punishment of the state. The term “*conscience*” also reverts back to **verses 1b–4** and to the God-ordained authority of the state and the idea that the state is God’s “minister.” Believers should obey the state because they know in their conscience that God has established the state as mediators of his rule. When Paul says that one must be subject “*because of wrath*” (διὰ τὴν ὀργήν, *dia tēn orgēn*), the wrath is identical with the wrath that the government exercises in **verse 4** (though it also points to God’s final judgment) and the judicial function of the government in **verse 2**. Thus **verse 5** simply restates the main thesis of **verses 1–4**, but it elaborates on what is implicit in those verses in saying that one should also be subject “*because of conscience*” (διὰ τὴν συνείδησιν, *dia tēn syneidēsin*). One should submit to government not only because it punishes wrongdoing but also because it is right and good to submit to its authority.

Douglas Moo: The word “*conscience*” (*syneidesis*) usually refers to that faculty within human beings that informs us of the **morality** of our actions after they have taken place. But the word can be used more broadly, and this seems to be the case here. *Syneidesis* here refers to our **consciousness of God and of his will for us**. Because we understand that God has appointed secular rulers, we must submit to them.

Michael Bird: This “*conscience*” (*syneidēsis*) refers to an inner moral compass that points people to a manner of life recognized as right by both God and people (see **Acts 23:1, 16; Rom 2:15; 9:1; 1 Cor 8:7, 10, 12**).

John Toews: The word conscience refers to the ability to reflect critically on what is appropriate. While it usually refers to past action, here it clearly refers to future action. If one thinks critically about the state of affairs in the world in light of God’s ordering of governing structures, Paul says, it is wise and prudent to submit to the governing powers.

III. (:6-7) PRACTICAL APPLICATION (EXAMPLES) OF SUBMISSION TO GOVERNING AUTHORITIES

A. (:6) Specific Example: Paying Taxes

*“For because of this you also pay taxes,
for rulers are servants of God, devoting themselves to this very thing.”*

B. (:7) General Examples: Render What Is Due

*“Render to all what is due them:
tax to whom tax is due;
custom to whom custom;
fear to whom fear;
honor to whom honor.”*

Frank Thielman: Paul speaks of four obligations to “everyone” (πᾶσιν), although the context shows that he is talking about all civil authorities (**13:1, 3–4, 6**). His list distinguishes between the *tribute* (φόρος) paid by subject peoples and the wide variety of *taxes* (τέλη) on property,

merchandise, and activities in the Roman world. The language of obligation was common in descriptions of such payments. Paul also reflects the cultural context of Rome in speaking of an obligation to repay with “*fear*” (φόβος) and “*honor*” (τιμή) the various officials who supervised the social order. The functionaries of Roman government from the emperor down viewed the honor they were accorded as a critical part of their compensation for serving. “The duty of respect,” said **Cicero**, “requires us to reverence and cherish those outstanding because of age or wisdom or office, or any other claim to prestige.”

* * * * *

DEVOTIONAL QUESTIONS:

- 1) When must evil rulers be resisted? Biblical examples? What should our view be towards Civil Disobedience?
- 2) What should the Christian’s view be towards capital punishment?
- 3) To what extent should Christians involve themselves in the political process to seek to bring about moral and cultural reforms?
- 4) How is a constant barrage of ridicule and criticism directed against our political leaders consistent with the scriptural injunction to honor leaders and respect them?

* * * * *

QUOTES FOR REFLECTION:

Thomas Schreiner: This text is misunderstood if it is taken out of context and used as an absolute word so that Christians uncritically comply with the state, no matter what is being demanded. Here we have a **general exhortation** that delineates what is usually the case: **people should normally obey ruling authorities**. The text is not intended as a full-blown treatise on the relationship of believers to the state. It is a general exhortation setting forth the **typical obligations** one has to civil authorities. Indeed, Paul envisions a situation in which the governing authority carries out its task by punishing evildoers and rewarding those who do what is good. . .

It was not his intention to detail here the full relationship of believers to the government. **Stein** (1989: 334) rightly says, “Governments, even oppressive governments, by their very nature seek to prevent the evils of indiscriminate murder, riot, thievery, as well as general instability and chaos, and good acts do at times meet with its approval and praise.” **Wright** (2002: 718) comments similarly, “There may be a sense here . . . that even when they are grievously deceived and almost demonic, ruling authorities still have a certain level of divine authorization.” Wright (2002: 716) also states, “Chaos and anarchy enable the powerful, the rich, and the bullies to come out on top, and they invariably do. God desires that even in the present time, even in the world that has not yet confessed Jesus as Lord, there should be a measure of justice and order” (cf. **Bertschmann** 2014: 243–44). Paul would not disagree with the call to obey God rather than rulers when they try to squelch the preaching of the gospel (**Acts 5:29**; cf. **Mart. Pol. 10.1–2**,

where rulers are respected but **Polycarp** will not render worship to the genius of Caesar). Nor would he dispute the claim that the state can function as an evil beast (**Rev. 13**), since John's teaching stems from **Dan. 7**, and Paul himself expects an evil ruler to arise (**2 Thess. 2:1–12**). The intention in Romans is to sketch the normal and usual relationship between believers and a ruling power (cf. **Titus 3:1; 1 Pet. 2:13–17**). Christians should submit to such authority and carry out its statutes, unless the state commands believers to do that which is contrary to the will of God.

Michael Bird: So Paul's call for submission seeks to avoid these two extremes of **over-realized eschatology** (kingdom is here, so ignore Caesar), and **under-realized eschatology** (kingdom is not here, so pick up your sword against Caesar and let's make the kingdom come). Paul might be saying something like, "Jesus is the Lord, the new age has dawned, but be that as it may, we cannot get ahead of ourselves and live as if authorities are not there. They are here, and for good reasons; God has appointed them to provide justice for their peoples. What is more, some hot-heads in Judea might be sharpening their swords for holy war, looking for opportunities to revolt, but that will not solve the problem; instead, it will replace imperial rule with lawless anarchy. God can bring Rome to its knees, and he does not need your sword to do it."

James Dunn: A community which no longer identified itself in **ethnic terms** could therefore no longer claim the political privileges accorded to ethnic minorities. Paul must have been very conscious that by redrawing the boundaries of the people of God in non-ethnic terms he was putting the political status of the new congregations at risk. Whatever he might claim about Gentiles being grafted into the olive tree of Israel, the **political reality** was that the new congregations were in process of shedding the identity of ethnic Israel, and the sociological reality was that the believers in Jesus as the Christ were breaking down or ignoring the very boundaries which had given the Jews their distinctiveness and thus their protection. Consequently, any attempted overview of the group identity and of the social relationships of Christian congregations in the diaspora would have to address **the issue of their political status** and what that meant in the reality of daily existence—and particularly in Rome, the very seat of imperial government.

Within the political structures of the Roman state the responsibilities and powers of government were clear. These responsibilities and powers were exercised by a few by right of birth, or connection, or wealth, or ruthless self-advancement. For the rest, the great majority, there was no political power and no realistic hope of wielding it. . .

a theology of the orderly state, of good government. The principle is simple and would have commanded wide assent: regularity in nature and orderliness in society is something provided for by nature and commended by divine reason; a society needs constraints in order to ensure "*the good*"; and it is one of the chief roles of a ruler that he is responsible for administering such constraints, for commending the "*good*" and punishing the "*bad*" (**vv 3–4**). In theological terms, the corollary of asserting that God gives dominion to kings and rulers is that he does so for the good of his creatures. In the matter of exercising political authority, rulers are "*servants of God*" (another echo of **Wisd Sol 6:4**). Their power is not their own; it comes from God. To resist them, therefore, in the exercise of their God-given responsibility is to resist God and so to incur his judgment and wrath (**vv 4–5**). Hence Paul can even say that submission to political authority

should be motivated not simply by fear of retribution but by concern for a good conscience—not simply a matter of accepting the harsh realities which cannot be changed, but a matter of theological principle. Such orderliness is part of the creative purpose of God. To cooperate in and submit to its working is all of a piece with the creature’s acknowledgment of the Creator. . .

Here we must recall that his advocacy of political quietism is in the context of the political powerlessness of most members of the ancient state. In contrast, our modern democratic traditions make it possible for individuals to exercise some political power and to pass judgment on whether rulers are operating for the good of their citizens.

Steven Cole: Christ: Lord of our Politics

Before we leave **Romans 13:1-7**, which is the longest New Testament passage dealing with Christians and the government, I wanted to address the topic of **to what extent Christians and the church should be involved in politics**. Some, such as **John MacArthur** (whom I greatly respect), argue that we should preach the gospel, but not be much involved in politics (*Why the Government Can’t Save You* [Word]). Others, such as **Tim LaHaye**, imply that getting conservative Christian candidates elected is of utmost importance. So I want to explore the implications of what it means to have Christ as Lord of our politics.

I must make several disclaimers. The first is that I cannot possibly be comprehensive in one message. I must limit my comments on many points where, if time permitted, much more could be said. If you want to read a more comprehensive, biblically-based book, I’d recommend **Wayne Grudem’s** *Politics According to the Bible* [Zondervan, 2010, 619 pages].

Second, my goal is not to give you pre-packaged answers on every issue, but rather to lay down some guidelines to help you think biblically about the subject of politics. And thirdly, I am still in process on some of these matters. Feel free to interact or disagree with me and we can help each other grow in this area.

My foundational proposition is: **Christ must be Lord of our political views.**

1. The nature of civil governments: God-ordained and accountable to God.

A. CIVIL GOVERNMENTS ARE ORDAINED OF GOD.

(1). GOD ORDAINS GOVERNMENT TO PROMOTE JUSTICE FOR ALL.

(2). GOD ORDAINS GOVERNMENT TO PROMOTE PEACE AND ORDER IN SOCIETY.

B. CIVIL GOVERNMENTS ARE ACCOUNTABLE TO GOD.

2. The relationship between the church and the government: Not total separation nor total identification, but education and confrontation.

A. NOT TOTAL SEPARATION: THERE IS NO SUCH THING AS TOTAL SEPARATION OF CHURCH AND STATE.

As you know, the phrase “a wall of separation between church and state” is not in the U.S.

Constitution. It occurs in a letter from Thomas Jefferson to the Danbury Baptist Association on January 1, 1802 and it reflects Jefferson's interpretation of the First Amendment. Originally the first amendment was added to insure that the federal government have nothing to do with state religious affairs and that the federal government be prohibited from establishing a national church (such as the Church of England). Several of the colonies had state churches. That was not in question.

The same Congress which drafted the Constitution reaffirmed the Northwest Ordinance in 1789 which states, "Religion, morality, and knowledge being necessary to good government and the happiness of mankind, schools and the means of learning shall forever be encouraged" (wikipedia.org). Thus religion and morality (based on religion) were a part of the foundation of our nation's educational system. The founding fathers would be aghast at the current interpretation of the First Amendment which excludes any mention of God or the Bible from public schools and the government.

Since part of the government's God-ordained function is to promote justice, and since, by necessity, that involves legislating morality, it is absurd to talk about a total separation of church and state. The church concerns itself with morality, and so there is much overlap. Freedom *of* religion does not mean freedom *from* religion. Church leaders and individual Christians should not withdraw from the government or public education under the guise of separation of church and state. On the other hand ...

B. NOT TOTAL IDENTIFICATION: THE CHURCH MUST BE CAREFUL TO BE KNOWN PRIMARILY FOR THE GOSPEL AND RIGHTEOUSNESS, NOT FOR A PARTISAN POLITICAL STANCE.

(1). EVANGELISM, NOT POLITICAL POWER, IS GOD'S PRIMARY MEANS OF DEALING WITH THE WORLD'S PROBLEMS.

(2). THE GOSPEL DOES INCLUDE MINISTRY TO THE WHOLE PERSON, AND SO WE CANNOT NEGLECT WORKING FOR JUST LAWS.

Thus to say that preaching the gospel is our only business and that the church should not influence the culture through promoting just and righteous laws is out of balance. It is often through Christian efforts to promote justice for the oppressed that God opens the door for the proclamation of the gospel.

(3). THE DOCTRINE OF DEPRAVITY MUST ALWAYS BE IN VIEW WHEN THE CHURCH TOUCHES POLITICS.

We need to be careful not to become overly enamored with a particular political party or candidate. The church should not posture itself as Republican or Democrat. Neither party is thoroughly biblical. There is a mixture of good and evil in both parties. And all candidates (even if they are Christians) are fallen sinners who are susceptible to the lust for power and prestige. We also need to realize that candidates of both parties posture themselves to appeal to large blocks of voters, such as "the Religious Right." We should

not be duped or overly optimistic that a candidate who says that he holds to “conservative family values” will actually promote those values once he is in office.

But when one party (or its presidential candidate) endorses abortion and homosexual rights, and the other party (or its candidate) stands on the opposite side, I don’t see how a Christian in good conscience can vote for the pro-abortion, pro-homosexual rights candidate. These are *moral* issues, not political issues. . .

C. EDUCATION AND CONFRONTATION: THE CHURCH MUST EDUCATE AND CONFRONT THE STATE ON MATTERS OF MORALITY AND JUSTICE.

This brings up the difficult question: *How far can we push Christian morality (legislatively) in a secular society?* During the colonial days, some states punished people who traveled on Sunday. I remember going into grocery stores in Texas in the late sixties where you could not purchase certain items on Sunday. Obviously, we don’t want to go that far (most of us would be guilty!). A few (thankfully, not many!) advocate imposing the Mosaic Law on our culture, including stoning adulterers, homosexuals, and rebellious children. But how far should we go?

I do not have all the answers on this! **Wayne Grudem** does an admirable job of addressing an extensive list of specific issues: protection of life (abortion; euthanasia; capital punishment; self-defense and gun ownership); marriage (including incest, adultery, homosexuality; polygamy; divorce; pornography); the family (including child-rearing and education); economics (including taxes; Social Security; health care); the environment (including global warming); national defense (including war; pacifism; homosexuals in the military); foreign policy (including immigration); freedom of speech; freedom of religion; and, a number of other special topics, such as affirmative action, farm subsidies, the National Education Association, Native Americans, and gambling.

Obviously, I can’t begin to deal with all of these specific issues here, but I want to lay out a few guidelines. (I’m relying on theologian **John Warwick Montgomery**, *Christianity Today* [1/23/81], pp. 60, 63; although I’ve modified his approach slightly.)

(1). WE MUST DISTINGUISH BETWEEN BIBLICAL MORAL ABSOLUTES AND GRAY AREAS.

(2). WE MUST NOT SEEK TO LEGISLATE EVEN BIBLICAL MORAL TEACHINGS WHERE THE VALUE OF THAT TEACHING WILL BE RECOGNIZED ONLY BY THOSE WHO HAVE ALREADY ACCEPTED CHRIST AS LORD AND THE BIBLE AS GOD’S WORD.

(3). WE SHOULD STRIVE TO LEGISLATE ALL SOCIALLY VALUABLE MORAL TEACHINGS OF SCRIPTURE WHOSE VALUE CAN BE MEANINGFULLY ARGUED FOR IN A PLURALISTIC SOCIETY.

(4). IN THE POLITICAL ARENA, IF THE CHOICE IS BETWEEN A REASONABLE COMPROMISE THAT HAS A GOOD CHANCE OF PASSING VERSUS THE

UNCOMPROMISED POSITION WHICH HAS A POOR CHANCE OF PASSING, GO FOR THE COMPROMISE.

3. The relationship between individual Christians and the government.

A. REQUIRED OF EVERY CHRISTIAN:

(1). TO BE SUBJECT TO THE GOVERNMENT UNLESS IT ASKS US TO DISOBEY GOD (**ROM. 13:1; 1 PET. 2:13-14; ACTS 4:19-20; 5:29; DANIEL 1, 3, 6**).

(2). TO GRANT PROPER HONOR TO THOSE IN AUTHORITY (**ROM. 13:7; 1 PET. 2:17**).

(3). TO DO RIGHT AND COOPERATE WITH GOVERNMENT AUTHORITIES WHENEVER POSSIBLE (**TITUS 3:1-2; 1 PET. 2:15**).

(4). TO PAY TAXES (**ROM. 13:6, 7; MATT. 22:17-21**).

(5). TO PRAY FOR GOVERNMENT AUTHORITIES (**1 TIM. 2:1-2**).

(6). TO EVANGELIZE AND DISCIPLE GOVERNMENT LEADERS WHEN POSSIBLE (**1 TIM. 2:3-4; MATT. 28:19**; PAUL'S EXAMPLE WITH FELIX, FESTUS, AGRIPPA, AND OTHERS).

(7). TO BE INFORMED AND VOTE FOR CANDIDATES AND ISSUES WHICH WILL, TO THE BEST DEGREE POSSIBLE, UPHOLD GOD'S PURPOSES FOR GOVERNMENT (**MATT. 5:13-16; TITUS 3:1**).

B. OPTIONAL FOR CHRISTIANS ACCORDING TO GIFTS AND CALLING:

(1). TO HELP INFORM THE CHURCH REGARDING CANDIDATES OR IMPORTANT LEGISLATION THAT RELATES TO BIBLICAL ISSUES.

Not all of us have the time to stay informed. If you are so gifted and led, help us out. Let us know about important petitions that we can sign to endorse moral legislation.

(2). TO WORK AS VOLUNTEERS OR SUPPORTING STAFF FOR POLITICIANS WHO UPHOLD JUSTICE AND MORALITY.

This is not required of every believer, but it may be the legitimate calling of some.

(3). TO RUN FOR POLITICAL OFFICE.

Again, this must be a matter of personal calling before God. It may be on a local level (school board, city council, etc.) or on a state or national level. The church ought to be supplying the government with men and women of integrity who fear God. Government is a difficult place to maintain a strong testimony for Christ. But there are two notable examples in the Bible of men who served well in pagan governments: Joseph in Egypt, and Daniel in Babylon.

<https://bible.org/seriespage/lesson-89-christ-lord-our-politics-rom-131-7-and-other-scriptures>

Brian Evans: Called to Be Subject to Governing Authorities

These seven verses contain the clearest and most specific New Testament teaching on the Christian's responsibility to civil authority. Every Christian, no matter what form of government he lives under, is under the command from the Lord to maintain proper and useful submission to that government for the sake of leading a peaceful life and having an effective witness. This recurring theme of submission to society's controlling power is nowhere more forcefully dealt with than here. . .

When God created the universe, it was first in chaos. The earth, for example, was formless and void. It was in chaos. God spoke and brought order to His creation, therefore, we submit to His authority because He has brought order. From our text today, we are commanded to submit to civil authorities because God has set them in place to bring order from chaos. . .

In the ancient world, tax collectors were considered the worst of sinners when actually, one that does it right is working for God. He is the one that collects the money from citizens who are benefiting from the work the government authorities do to keep them safe etc.

So, beloved, we are to pay the taxes we owe, we are to pay the revenue we owe (this includes other things like licenses, permits, etc.), respect and honor we owe these who stand over us in society.

We realize, don't we, that we live in a fallen world and those placed in authority over us are often not Christian. They use their power for personal gain. They lie, cheat, and steal and get away with it. We have seen this over and over again. So, we all realize that in a sinful fallen world there are many imperfections in God's system of government. Yet a fallen government is far better than no government at all. We are very quick to point our fingers at corruption within civil servants and those in power, but we must also be careful because we are also corrupt.

<https://gccwaverly.net/2018/11/18/sermon-called-to-be-subject-to-governing-authorities-romans-131-7/>

Albert Mohler: Romans 13:1-7

My purpose today is not going to be to argue about the size of government or the appropriate structure of government. There are some interesting thoughts along a biblical line, as we think about those big questions . . . But this is just about government anywhere, everywhere in this age, what does it mean? And how are Christians to think about it? . . .

In a biblical worldview, the **family** itself is a government. It is a structure, not only of a romantic and intimate nature, it's also a structure of a **social nature**. As a social nature, it is either rightly or wrongly arranged, just like government is rightly or wrongly directed, But the reality is that **the first government is the family**. But beyond the family, in keeping with the dominion command and theme and commission, then there is an expansion of government and it will show up. It'll show up in various ways. In the Old Testament, it will show up in the life of Israel, after all. It will show up in tribal forms. It will show up in national forms. It will show up even in Imperial forms. . .

Judges 21:25 is a classic text warning about **anarchy**. “*In those days, there was no king in Israel, and everyone did what was right in his own sight.*” That’s the horror. That is one of the central terrifying verses of the Old Testament. It is a terrifying verse of human disobedience, of **disorder** that threatens not only the efficiency and the security and the safety of God's people, but of course subverts their faithfulness to God. And even that was complicated, because God did not intend for Israel to have a king, but rather for his Lordship over them, his sovereignty over them, to be dispensed and efficiently done through the authorities of Israel without a king, without a mediating king. But Israel demanded a king, because all the peoples around them had Kings, and Kings had armies, and Kings were visible. This turns out to be a part of the logic of the demand for kingship. You can see a king, and you know the king is there, and the king surrounds himself with glory, and he has power, and he can raise an army. Those Kings and their armies were a threat to Israel, who thought they could find security in having their own king. God warned through Samuel. He warned the people what they would have. If they had a king, then guess what? He's going to take your sons and send them to war. He will take your daughters as wives. He'll take a lot more, as a matter of fact. . .

Romans chapter 13 is **categorical** in so many ways. *let every person-- categorical... Be subject to the governing authorities--categorical... and then the ultimate categorical statement: for there is no authority except from God, and those that exist have been instituted by God.* That is one of the most fundamental verses of any Christian worldview. It's one of those verses that has to carry an enormous amount of freight. It's a clarifying verse. And in one sense, it's almost a terrifying verse. . .

So is our responsibility to obey every authority unconditionally? . . .

What are the governing principles of the **United States** and our government system of **constitutional democracy**? We say it's a government by the people, for the people, in the name of the people. And there's a certain sense in which that's very meaningful, in contrast with other political systems. . .

There is an honor due to the emperor, but it is not the honor of God. Let’s remind ourselves also of what Peter and John said in **Acts 5:24**. “*We must obey God rather than human beings,*” period. And you'll notice that they don't just say “rather than Caesar, or the Sanhedrin.” They don't mention any particular government, because it's a generally applicable principle reminding ourselves that all human authorities are mere human beings. They are not to be worshiped. **There is a limit to what Caesar can demand**, and that limit is a distinction between the coin and the human being. The distinction between what Caesar can rightfully claim and what Cesar cannot rightfully claim.

Christians throughout all the centuries has struggled, most excruciatingly in the centuries of greatest political crisis, has struggled with exactly how to understand this. **What are those limits?** There is no easy way to define this. **Augustine** spoke to this very clearly in his Commentary on the Romans at point 72. he said, “So if anyone thinks that because he is a Christian, he does not have to pay taxes or tribute, nor show the proper respect to the authorities who take care of these things, he is in very great error. Likewise, if anyone thinks that he ought to submit to the point where he accepts that someone who is his superior in temporal affairs

should have authority over his faith, he falls into even greater error, but the balance which the Lord himself prescribed as to be maintained. *Render under Caesar, the things that are Caesar, but unto God the things that are God's.*” Thankfully, we have enough here to know the limit language. Caesar has no right to claim her soul. Caesar has no right to claim worship. Caesar has no right to cause us to deny Christ or the rule of Christ, but Caesar can demand almost anything else.

Figuring out the boundary between what is owed Caesar and what is not owed Caesar, figuring out the boundary between worshiping and obeying God by obeying the government, and when one can only disobey God by obeying the government, that's a hard thing to figure out. It's much more complex than can be addressed in any message. But we do know this. Government itself is a gift. Anarchy is the curse. There is no authority except that which has been instituted by God, and all authority comes from God. So we're thankful for authority. We're thankful for government, in the sense that we're horrified by the thought of anarchy. We know that government has a proper claim on us. **It's a massive claim, but it's not a limitless claim.** It's not an eternal claim. It's not a spiritual claim. Figuring out all of this is not going to be easy, and that's why we'll have to return to this again.

But we are left with that very enigmatic statement found in Peter. *“Honor everyone, love the brotherhood, fear God, honor the emperor;”* and that which is given to us by Paul, *“taxes to whom taxes are owed, revenue to whom revenue is owed, respect to whom respect is owed, honor to whom honor is owed.”* The bottom line I leave you with is this: the Scripture makes very clear that there is a derivative honor that we owe to those who are honorable. But the only ultimate ascription of honor is to God himself. The honorable task for Christians is **figuring out to whom honor is due.**

<https://albertmohler.com/2020/02/20/romans-131-7-2>

John MacArthur: Seems to me that the church needs to use all of its power and all of its resources, and all of its energy and forces to convert men and women to Jesus Christ. And that's what God has called us to do. The Scripture speaks not at all about Christians engaging in politics. It has nothing to say about it. Other than the fact that we're to be model citizens, it says nothing. It speaks not at all about Christians engaging in civil change. That is not our priority. It doesn't mean we're not to be involved as citizens where we can be. It's a question of priority. . .

We are to be - and listen carefully, this is an important thought - we are to be the conscience of the nation by godly living and faithful preaching. We confront the nation, not through political pressure, but through the word of God. That's how we confront the nation. We preach against sin. We preach against the evils of our time. But it is preaching and godly living that is our calling. . .

Submit to the government and pay your taxes. That's our duty. Beyond that, you ought to be busy in the kingdom. Right? Busy doing that thing which is eternally valuable. It isn't the other things are not important, it is that they pale in importance when compared with the work of the kingdom. That's the issue.

Leedy Greek NT Diagrams:

Rom 13:1

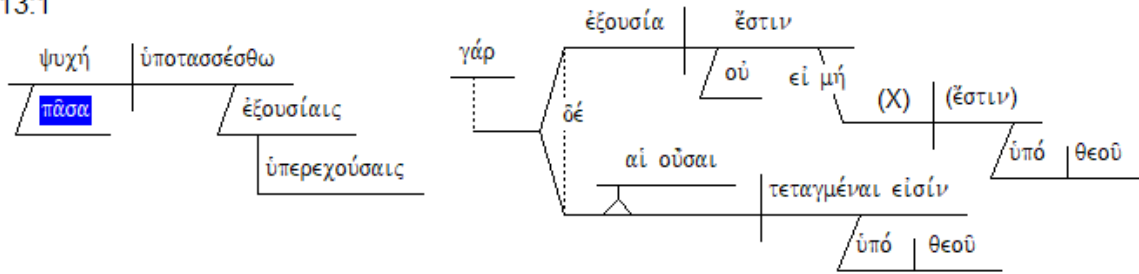

Rom 13:2

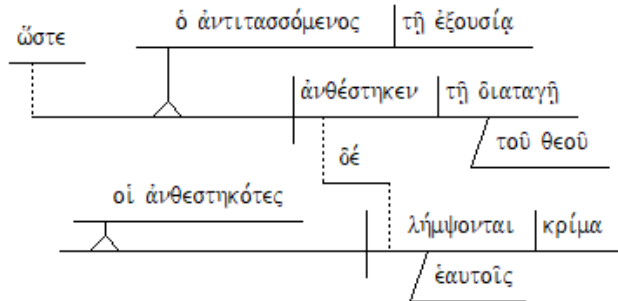

Rom 13:3-4

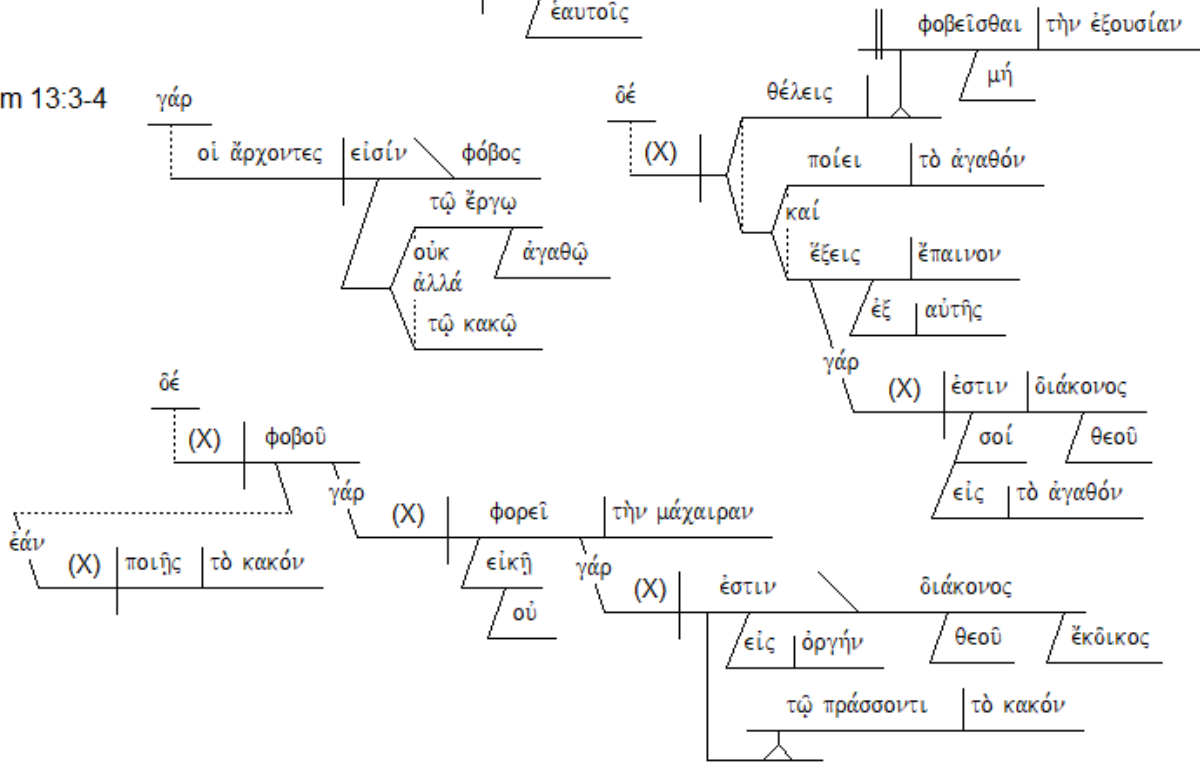

Rom 13:5

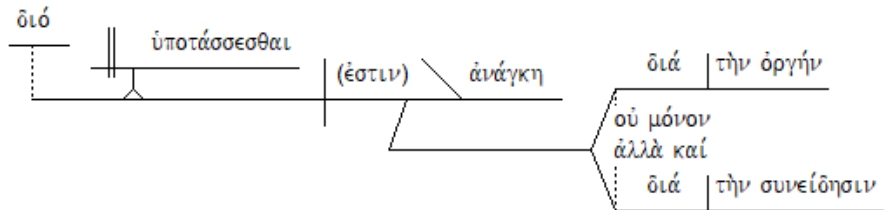

Rom 13:6

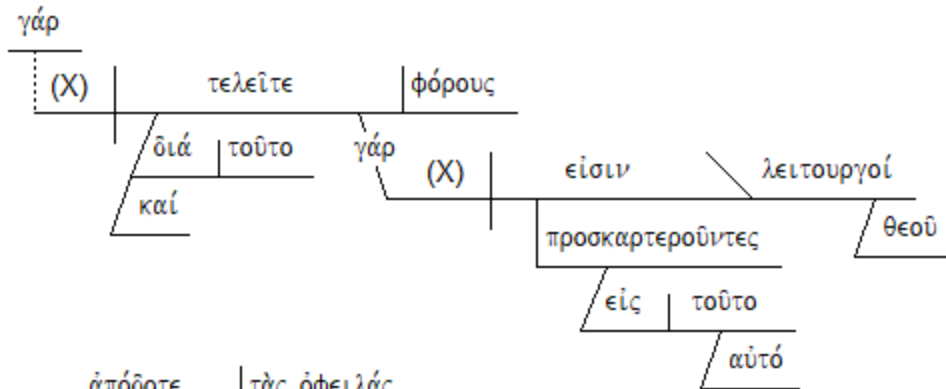

Rom 13:7

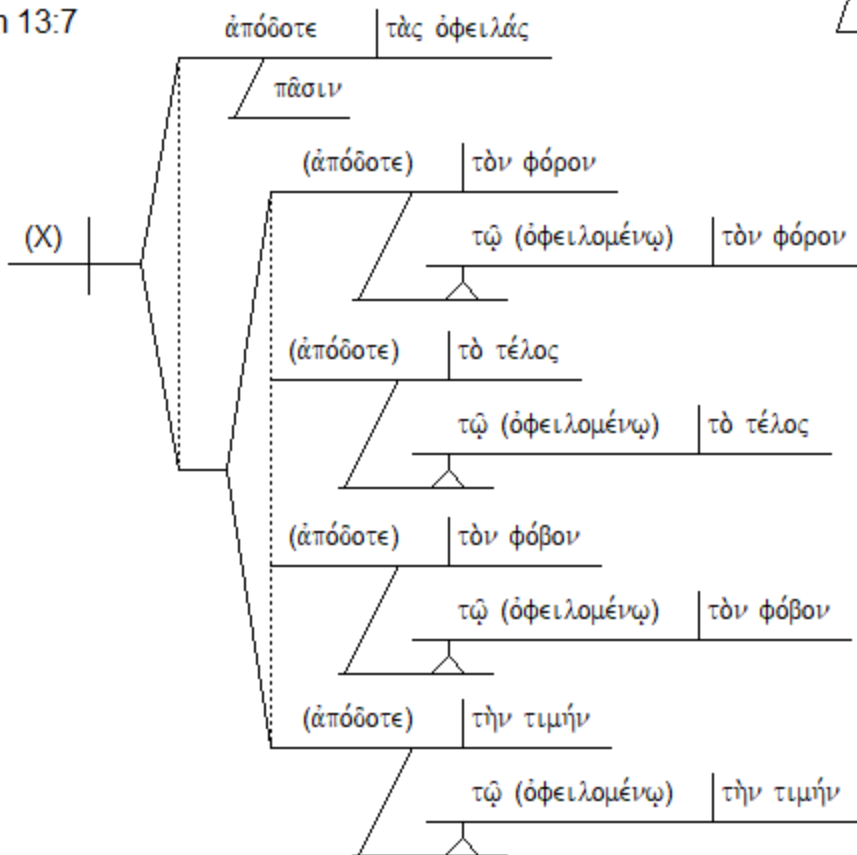

Frank Thielman:

- 1a Exhortation **Let every person submit** themselves to the ruling authorities.
- b Basis 1 (of 1a) For **no authority exists except by God,**
- c Restatement and **those that do exist are set in place by God.**
- 2a Inference So, **the one who opposes authority has become rebellious**
against the ordinance of God,
- b Result and **those who are in rebellion will receive judgment**
Disadvantage against themselves.
- 3a Basis 2 (of 1a) For **officials are not a threat** to what is good, but
to what is evil.
- b Rhetorical Question **Do you want to be free from fearing governmental authority?**
- c Means **Do what is good,**
and **you will have praise from it.**
- 4a Basis (of 3c) For **she is the agent of God for good,**
for your benefit.
- b Condition But
if you do evil,
fear.
- c Basis (of 4b) For **she does not wear the sword in vain,**
- d Explanation for **she is the agent of God,**
one who distributes justice,
- e Result (of 4d) resulting in wrath for the one who does evil.
- 5a Summary (of 1b–4) Therefore, **to submit one's self is a necessity,**
- b not only because of that wrath
- c but also because of the conscience.
- 6a Basis (of 5) For because of this **you pay tribute,**
- b Basis (of 6a) for **they are servants of God,**
- c devoted to this very purpose.
- 7a Exhortation **Repay your obligations to everyone,**
- b List tribute to whom tribute is due,
- c List tax to whom tax is due,
- d List fear to whom fear is due,
- e List honor to whom honor is due.

TEXT: ROMANS 13:8-14

TITLE: LOVE MUST BE THE ESSENCE OF CHRISTIAN CONDUCT SINCE CHRIST WILL SOON RETURN

BIG IDEA:

WE ARE TO SERVE GOD BY LOVING ONE ANOTHER WHILE WE STILL HAVE OPPORTUNITY

INTRODUCTION:

Douglas Moo: While **13:8–10** connect in substance to **12:9–21**, Paul cleverly plays on the notion of “*debt*” that he introduced in **13:7** to create a transition back into the topic of love.

John Toews: It is important to note that the night has not ended, but is far advanced. The light of day has not yet come, but soon will. Believers in Rome live at the edge of the great change between this age and the age to come, on the cusp of the tension between what is and what shall be. . .

Eschatology motivates new thinking and behavior. But the eschatological teaching itself is minimal. The present age is passing away. The hour of salvation is very near, but still future. The *kairos* moment in which Christians live requires critical thinking and living which is informed by light rather than darkness.

Michael Bird: The section obviously breaks down into two discernable parts:

- (1) the love command (vv. **8 – 10**); and
- (2) the call to live uprightly as believers wait for the consummation of their salvation (vv. **11 – 14**).

While many commentators separate the love command of vv. **8 – 10** from the future hope of vv. **11 – 14**, Paul clearly connects the two together. Paul begins v. **11** with “*And do this,*” with “*this*” relating back to the prior love command. Love of neighbor is to be undertaken in the context of waiting for “*salvation*” (v. **11**). Believers should avoid the immoral excesses of pagan living (v. **13**) and instead clothe themselves with Christ as they prepare for the return of Christ (v. **14**). . .

Paul’s blend of ethics and eschatology forces us to think of innovative ways in which we can live out our sense of mutual obligation to each other in light of the impending return of Jesus to consummate God’s purposes on earth. The three main practical consequences that emerge are

- our debt of love,
- fleeing to God, and
- putting on the armor of light.

Michael Gorman: As he does in **Gal 5:14, 22** Paul here summarizes the second table of the law (**13:9**, drawn from **Exod 20** and **Deut 5**) in the words “*Love your neighbor as yourself.*” This summary does not negate or replace the more specific commandments but reveals what each is: a **call to love**. Paul understands love positively as that which edifies and honors (**12:9–13**; cf. **1 Cor 8:1**), and negatively as that which does no harm (**13:10**, reflecting the prohibitions in **13:9**).

David Thompson: Apparently the Apostle Paul was facing some form of spiritual somnambulism in the church of Rome. Some of the believers were walking through life sound asleep, spiritually speaking. These people were coming to the services, they were singing the songs, they were listening to the Scriptures being read and taught, but then they would leave as some type of spiritual zombie. Their spiritual senses had been lulled to sleep.

The Apostle Paul wanted the believers in Rome to be awake, alert and active, and the central motivating factor for this was the coming of Jesus Christ. . .

THE REALITY THAT WE ARE NEARING THE COMING OF JESUS CHRIST IS A REALITY THAT SHOULD MOTIVATE US TO BE AN ACTIVE DEMONSTRATION OF THE RIGHTEOUSNESS OF GOD.

According to the Apostle John, this thought of seeing Jesus Christ should have a purifying effect on God's people (**I John 3:3**).

I. (:8-10) LOVE FULFILLS EVERY COMMAND OF GOD

A. (:8) Love Fulfills the Law by Paying Our Obligation to Our Neighbor

*“Owe nothing to anyone except to love one another;
for he who loves his neighbor has fulfilled the law.”*

Bob Deffinbaugh: Paul is not saying that we should never incur debts, but that we should quickly and speedily pay every debt except that of love. We should strive to love, but we should never consider the debt 'paid in full.'

B. (:9) Love Fulfills the Law by Treating Your Neighbor as Yourself

“For this, ‘You shall not commit adultery, You shall not murder, You shall not steal, You shall not covet,’ and if there is any other commandment, it is summed up in this saying, ‘You shall love your neighbor as yourself.’”

Douglas Moo: “summed up” -- Two main possibilities emerge.

(1) Paul may mean that love for others is the **essential ingredient** that must accompany obedience to all the other commandments. We must still obey these commandments, but they cannot truly be obeyed without a loving spirit.

(2) Paul may also mean that the demand of love for others **replaces** the other commandments. When we truly love “*the other*,” we automatically do what the other commandments of the law require. As Paul puts it in **verse 10**, “*love does no harm to its neighbor.*” No one who truly loves another person will murder, commit adultery, steal, or covet.

We think the latter interpretation is closer to the truth. As we have argued, Paul elsewhere proclaims that believers are released from the binding authority of the Mosaic law (see **6:14–15; 7:4–6**). Paul's use of “*fulfillment*” language in this paragraph (**13:8, 10**) also suggests that he

views the love command as the eschatological “replacement” for the various commandments of the Mosaic law (see **Gal. 5:13–15**).

C. (:10) Love Fulfills the Law by Doing No Wrong to Our Neighbor

“Love does no wrong to a neighbor; love therefore is the fulfillment of the law.”

Thomas Schreiner: The word πλήρωμα (*fulfillment*) in this instance is synonymous with the term πλήρωσις (*plērōsis*), and thus the sense is that love fulfills the law. By loving, a person puts the law into practice. This is supported by the connection between **verse 10a** and **10b**, for in the former sentence love “*does not work evil*” (κακὸν οὐκ ἐργάζεται, *kakon ouk ergazetai*) to the neighbor. The use of the word ἐργάζεται demonstrates that the **activity of love is intended**.

II. (:11-14) LOVE SEIZES LIFE’S FADING OPPORTUNITIES TO DISPLAY JESUS CHRIST – UNDERSTANDING THE TIMES URGES RIGHT LIVING

Thomas Schreiner: The basic **structure** of this text is not difficult to identify. **Verse 11a** begins with a summons to action. This summons is based on the nearness of the eschaton (**vv. 11b–12a**). **Verses 12b–14** recapitulate more specifically the call to ethical behavior. The argument in **verses 11–14**, therefore, is in the form of a sandwich, and the middle section (**vv. 11b–12a**) forms the basis for the exhortations in **verses 11a** and **12b–14**. The flow of thought is represented as follows:

Carry out all of **12:1 – 13:10** (**v. 11a**),
because the end is coming soon (**11b**).
Since the end is coming soon (**vv. 11b–12a**),
we should lay aside the works of darkness (**vv. 12b–14**).

Douglas Moo: We need to recognize both what God is doing and what he plans to do and then live accordingly. The verses of the paragraph fall neatly into these two basic categories:

- Understanding the times (**13:11–12a**, the “indicative”)
- leads to right living (**13:12b–14**, the “imperative”).

James Dunn: The imagery used has two features.

- (1) It is strongly **temporal**—“*time*,” “*hour*,” “*near*,” “*far advanced*,” “*at hand*” (**vv. 11–12**).
- (2) It is strongly **contrasting**—“*wake up from sleep*,” “*night*” / “**day**,” “*put off*” / “*put on*,” “*darkness*” / “*light*,” “*decently*” / “*revelry, drunkenness*,” etc., “*put on Christ*” / “*make no provision for flesh*.”

The combined effect is powerful. The readers are left in no doubt that there is a sharp “either-or” confronting them, not only in their original decision to accept the gospel, but precisely as a result of their decision to accept the gospel. A choice once made has to be confirmed and lived out in a whole sequence of repeated decisions.

A. (:11-12a) Understanding the Times = Life’s Fading Opportunities

1. (:11) Urgency of the Hour

“And this do, knowing the time, that it is already the hour for you to awaken from sleep; for now salvation is nearer to us than when we believed.”

Thomas Schreiner: What this text in particular emphasizes is that **the end is drawing nearer**. The experience of salvation is “nearer” (ἐγγύτερον, *engyteron*) “*than when we believed*” (ἢ ὅτε ἐπιστεύσαμεν, *ē hote episteusamen*). There is no doubt that the term “salvation” here designates a **future** salvation that is not yet the possession of believers; it is a salvation that will be theirs when the day of the Lord commences. The verb ἐπιστεύσαμεν (*we believed*) is ingressive (so **Cranfield** 1979: 681; **Dunn** 1988b: 786), denoting the inception of belief. The time that has elapsed since they began to believe has only brought salvation closer.

Grant Osborne: Believers must be vigilant, alert, and not caught unaware. Paul knows that the old sinful nature will still cause problems from time to time, but he requires believers to stay “*awake*.” Remaining too long in a state of **spiritual lethargy**, where sin is tolerated and good works are not pursued, can lead to a spiritual coma, rendering us unresponsive to God (see **1 Corinthians 15:34; Ephesians 5:14**).

2. (:12b) Unveiling of the Day

“The night is almost gone, and the day is at hand.”

Frank Thielman: Those who have believed the gospel and become God’s people live at a critical moment in salvation history, just before God himself comes to restore justice and peace to the earth. God’s people should anticipate this future restoration in the way they live in the present. To continue the metaphor, it is time to throw the covers off the bed, pull on some clothes, and pick up the weapons of justice, peace, and love with which to fight for the purposes of God.

B. (:12b-14) Urges Right Living = Display Jesus Christ

1. (:12b) Put Off and Put On

a. Put Off Deeds of Darkness

“Let us therefore lay aside the deeds of darkness”

b. Put On Armor of Light

“and put on the armor of light.”

2. (:13) Live Properly

a. Proper Behavior

“Let us behave properly as in the day,”

b. Improper Behavior

*“not in carousing and drunkenness,
not in sexual promiscuity and sensuality,
not in strife and jealousy.”*

Douglas Moo: Verse 13 carries on the contrast between the behavior typical of the daytime/the Day of the Lord and that characteristic of the nighttime/this present evil age. The Day of the Lord may not have come yet, but it is so close that we should live as if it were here. We should “walk [*peripateo*; NIV, *behave*] *decently*,” which suggests behavior that is careful, decorous, and restrained (see **1 Cor. 7:35; 12:23, 24; 14:40; 1 Thess. 4:12**). We are to avoid, in contrast, those actions typical of the nighttime: unrestrained sexual conduct and drinking to excess (i.e., what we today call partying). Interestingly, Paul concludes his list with some unexpected items: “*dissension and jealousy*.” He probably adds these because he is thinking ahead to the next subject he will address: the **divisions** in the Roman community (**ch. 14**).

Steven Cole: Paul spells out the world’s deeds of darkness with three couplets of sinful behavior. These are not comprehensive, but representative. Also, the fact that he commands Christians to lay aside these deeds of darkness shows that we are not immune from doing them. As believers, we must be on guard so that we are not enticed by these sins.

First, the deeds of darkness consist in carousing and drunkenness. The Greek word translated “*carousing*” was used generally of “feasts and drinking parties that are protracted till late at night and indulge in revelry” (**Joseph Thayer**, *A Greek-English Lexicon of the New Testament* [Harper and Brothers, 1887], p. 367). Many first century believers came out of backgrounds where they had “*pursued a course of sensuality, lusts, drunkenness, carousing, drinking parties, and abominable idolatries*” (**1 Pet. 4:3**). Paul lists drunkenness and carousing as deeds of the flesh (**Gal. 5:21**). But such things are not appropriate for believers. . .

Second, the deeds of darkness consist in sexual promiscuity and sensuality. The first word refers here to sexual intercourse outside of marriage. The second word means licentiousness and unrestrained lust. It is also a deed of the flesh (**Gal. 5:19**), characteristic of unbelievers, not of believers (**Eph. 4:19-20**). God has given the marriage relationship as the proper place for sexual relations. To engage in any sexual activity outside of marriage is to participate in the deeds of darkness (**Eph. 5:3-12**).

Let me remind you that no one who is walking in the light suddenly and without warning falls into sexual immorality. Sexual sin always begins when we toy it in our minds. We relish lustful glances by replaying them in our thoughts. We sneak a peak at pornography, which leads to more frequent and longer looks. Eventually, the temptation to flirt with a tempting woman comes and it sucks us into the fatal act (see **Proverbs 7**). The key to avoiding it is to judge every sinful thought as quickly as it happens and to make no provision for the lusts of the flesh. Much of our sin can be traced to the fact that we made provision for it by toying with it.

Third, the deeds of darkness consist in strife and jealousy. These are relational sins that we often shrug off as no big deal. But they are opposed to the second greatest commandment, which is to love others as we love ourselves. **Leon Morris** observes (*The Epistle to the Romans* [Eerdmans/Apollos], p. 473), “Both indicate a determination to have one’s own way, a self-willed readiness to quarrel. All six of these vices stem from **self-will**; they are all the outreach of a determined **selfishness** that seeks only one’s own pleasure.” They are all a failure to love.

3. (:14) Put On and Put Off

a. Put On the Lord Jesus Christ

“But put on the Lord Jesus Christ,”

Douglas Moo: In one sense, of course, we are already clothed with Christ (**Gal. 3:27**). By faith we belong to him. He is “*in [us]*” (**Rom. 8:10**), and we are “*in [him]*” (**6:11**). But Paul wants us to make Christ the focal point of everything we do. He should be like a suit of clothes that we wear all the time. His dominating presence should guide us to do things pleasing to God and restrain us from activity inconsistent with the Lord whom we represent.

b. Put Off the Deeds of the Flesh

“and make no provision for the flesh in regard to its lusts.”

Frank Thielman: The expression “*to make provision for something*” (πρόνοιαν ποιῆσθαι τινος) was idiomatic for *having regard for* (**Demosthenes**, Against Meidias 97) or *making preparations for* (**Dan 6:19 LXX**) something or someone. Here it probably refers to placing one’s self in situations that might lead to the debauchery and divisiveness he has just mentioned in **13:13**.

* * * * *

DEVOTIONAL QUESTIONS:

- 1) Does this passage prohibit Christians from taking on any financial debts? How can we know when incurring a debt (home loan, car loan, etc.) is a wise type of obligation?
- 2) What is the relationship between the Christian and the OT Mosaic Law?
- 3) How should our motivation for the type of life we live be impacted by our understanding of the nearness of the return of Jesus Christ?
- 4) What does it mean and what does it look like to *put on Jesus Christ*?

* * * * *

QUOTES FOR REFLECTION:

Thomas Schreiner: From this brief foray into other Pauline texts, we can conclude that the alternation between the **indicative** (you have been clothed with Christ and laid aside the old person) to the **imperative** (put on Christ and lay aside the old person) is characteristic of Pauline thought. Thus the imperatives that dominate this text should never be sundered from the indicatives. **Romans 13:11–14** reminds us, however, that the indicatives do not rule out the need for imperatives. Even though believers have already “*put on Christ*” (**Gal. 3:27**; **Col. 3:10**) and put off the old person (**Col. 3:9**), they must also put on Christ (**Rom. 13:14**) in the concrete circumstances of everyday life. The desires of the flesh (**Rom. 13:14**) still threaten believers, and thus a conscious effort is needed so that no provision is made for them. The tension between the

indicative and imperative is due to the **already-but-not-yet paradox** that characterizes Paul's theology. The recognition that the decisive act of salvation has been accomplished and that the end is impending motivates believers to live in a new way.

Steven Cole: Although this text is not directly evangelistic, it is the text that God used to save **Augustine**. He had been a promiscuous young man and had lived for some years with a mistress. He had come under conviction of sin and wanted to be saved, but he had not yet gained assurance of God's forgiveness. He was weeping over his spiritual condition as he sat in the garden of a friend when he heard a child singing, "Take up and read! Take up and read!" He picked up a scroll that lay nearby and his eyes fell on the words, "Not in carousing and drunkenness, not in sexual promiscuity and sensuality, not in strife and jealousy. But put on the Lord Jesus Christ, and make no provision for the flesh in regard to its lusts." At that point, he said (*Confessions*, 8.12), "Instantly, as the sentence ended—by a light, as it were, of security infused into my heart—all the gloom of doubt vanished away."

David Thompson: In December of 1734, **Jonathan Edwards**, the great revivalist, preached a sermon he called "*The Preciousness of Time and the Importance of Redeeming it.*" In that sermon, there were several points he made and we will give you five:

- 1) Time is very short and very precious;
- 2) We do not know how much time we have left;
- 3) We cannot regain time already gone;
- 4) We are accountable to God for what we do with our time;
- 5) We need to improve the use of our time.

(The Works of Jonathan Edwards, Vol. 2, pp. 233-236)

Ray Stedman: I am afraid that we often hear men preaching who are aware of the fact that the age is drawing to a close, but their word to us is not to **wake up**, but to **hurry up**. Yet, as I turn to the pages of the New Testament, I never find that word "hurry" occurring. It isn't "hurry up," it is "wake up" that the Lord is continually saying to us. It is not hurry that is needed. Back in Isaiah, Isaiah says, "*He that believeth need not make haste*" {cf, **Is 28:16** KJV}. That is a wonderful word: "*He that believeth need not make haste...*" It is not hurry that is needed, it is awareness. "*Watch,*" Jesus said over and over to his disciples. "*What I say unto you I say unto all, Watch,*" {Mk 13:37 KJV}. Act intelligently. Don't act in panic, but in knowledge. Be aware of what you are doing. Act purposefully and intelligently, Wake up! (*The Demand of the Hour*)

David Guzik: Because we know the danger of the times and we anticipate the soon return of Jesus, we should be all the more energetic and committed to a right walk with God instead of a sleep-walk with God.

How important it is to awake out of sleep! We can do many Christian things and essentially be asleep towards God. What a difference it makes when we are awake!

- We can speak when we are asleep
- We can hear when we are asleep
- We can walk when we are asleep
- We can sing when we are asleep
- We can think when we are asleep

Leedy Greek NT Diagrams:

Rom 13:8

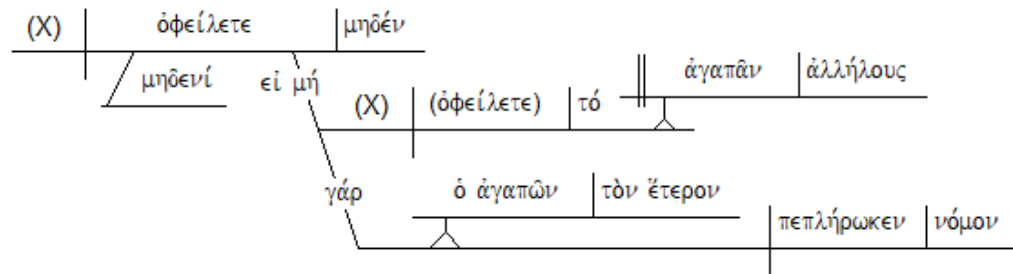

Rom 13:9

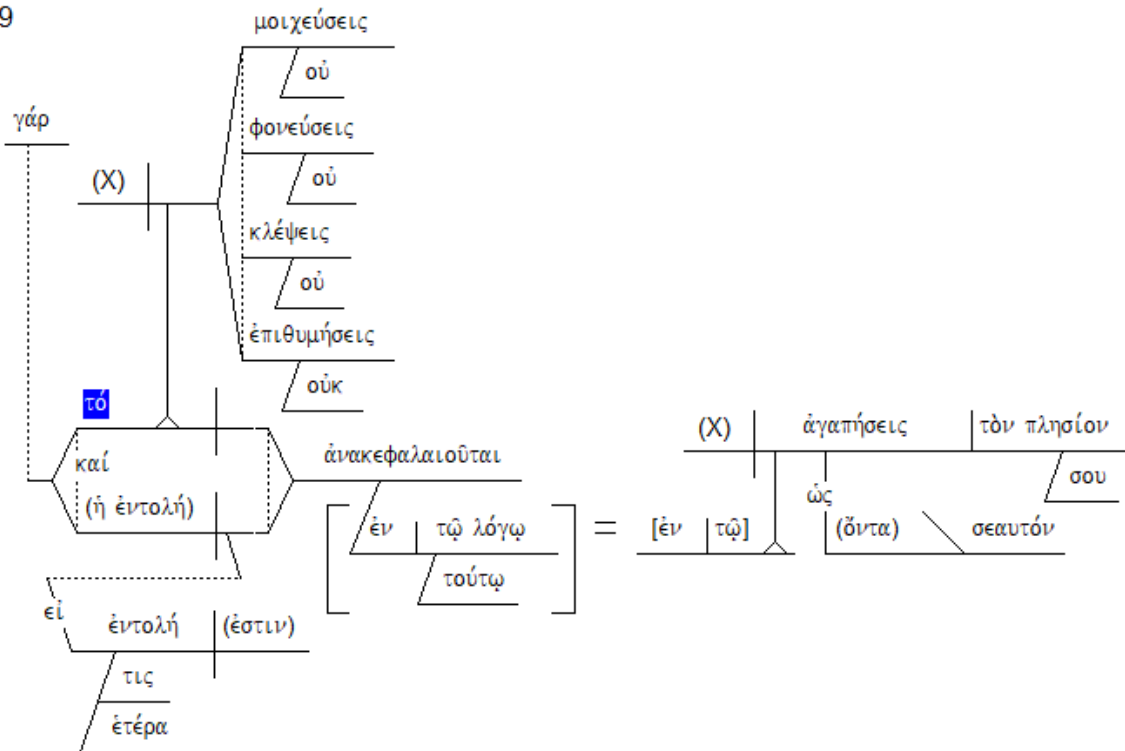

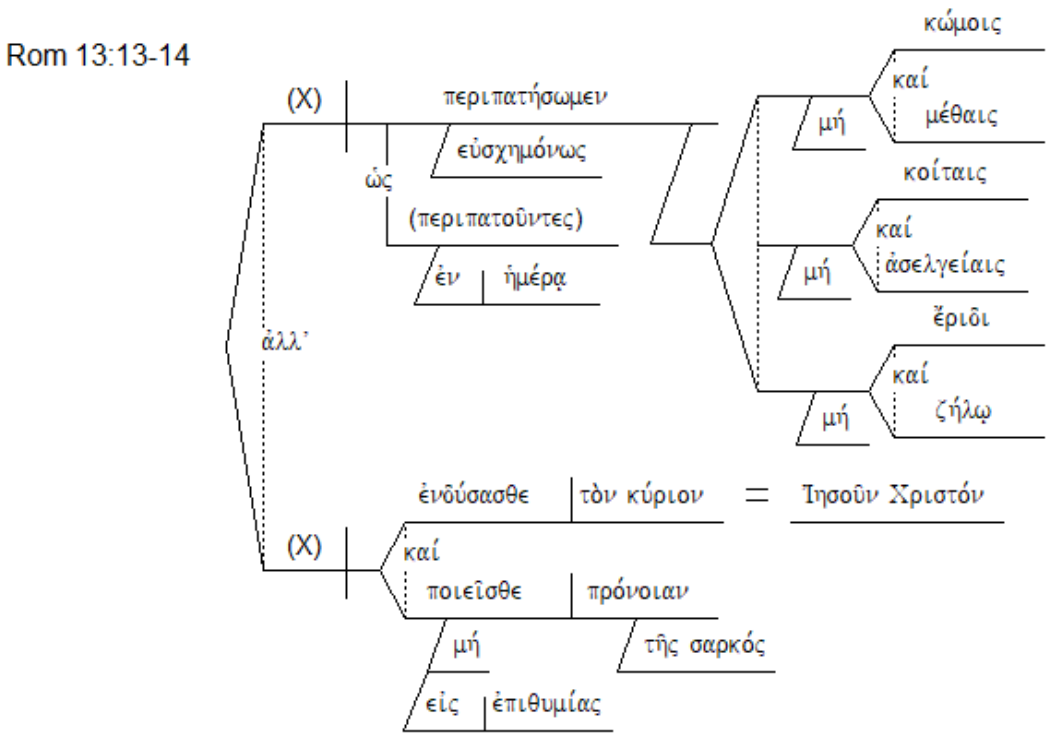
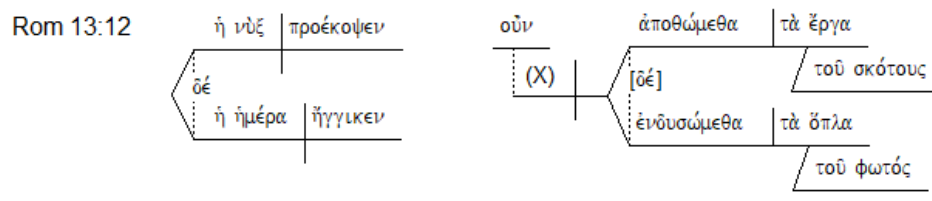
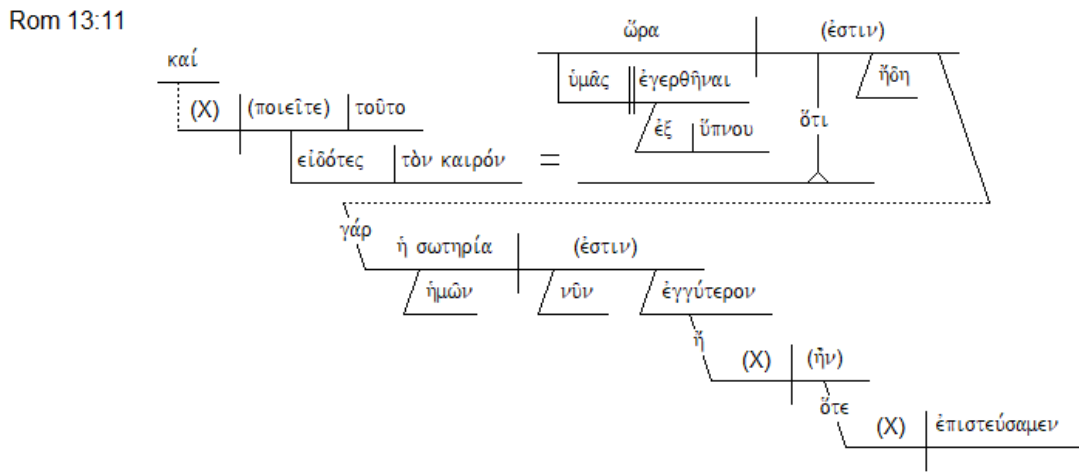
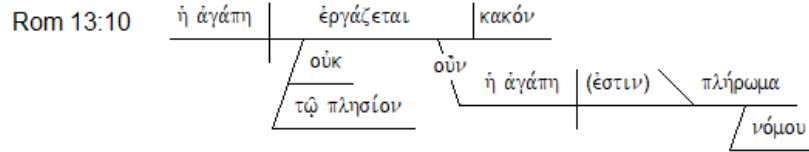

Frank Thielman:

- 8a Exhortation **Owe**
no one anything
except to love one another,
- b Basis (of 8a) for **the one who loves the other has fulfilled the law.**
- 9a Explanation (8) For **the list,**
"You shall not commit adultery; (Exod 20:14; Deut 5:18)
you shall not murder; (Exod 20:13; Deut 5:17)
you shall not steal; (Exod 20:15; Deut 5:19)
you shall not covet" (Exod 20:17; Deut 5:21) (and if there is any other ☞
commandment)
is summarized in this statement:
- b Summary (of 9a) "You shall love your neighbor as yourself." (Lev 19:18)
- 10a Restatement (of 9) **Love does nothing wrong to a neighbor;**
- b Inference (from 10a) therefore **love is the fulfillment of the law.**
- 11a Basis (of 8a) And **this**, because you know the time—
b Expansion (of 8a) that it is already the hour for you to wake up from sleep,
- c Basis (for 11b) for **our salvation is nearer now than when we first believed.**
- 12a Assertion **The night has advanced,**
- b Restatement (of 12a) and **the day has drawn near.**
- c Exhortation/Inference **Let us throw off, then, the works of darkness**
- d Restatement (of 12c) and **put on the weapons of light.**
- 13a Exhortation/Inference **Let us go around**
b Expansion (of 13a) presentably, as if it were day,
c Contrast not in orgies and drinking bouts,
d not in sexual liaisons and self-abandonment,
e not in contention and envy.
- 14a Contrast (to 13b–d) But **put on the Lord Jesus Christ,**
- b Contrast (to 14a) and **do not make provision for the flesh**
c for the purpose of sinful desires.

TEXT: ROMANS 14:1-12

TITLE: ACCEPTING BRETHREN WITH DIFFERING CONVICTIONS

BIG IDEA:

WE ARE TO SERVE GOD OUR ULTIMATE JUDGE BY ALLOWING FELLOW-BELIEVERS THE FREEDOM TO HOLD DIFFERING PERSONAL CONVICTIONS IN DISPUTABLE MATTERS

INTRODUCTION:

Grant Osborne: Paul had already established the equality of Jewish and Gentile believers. In this chapter he continues to discuss how that equality could work out in daily living. Paul focuses on two issues: dietary restrictions and observance of special days. Next to circumcision, diet and calendar were the most sensitive issues that separated Jews from all Gentiles. Now, as Jews and Gentiles attempted to work out their distinctive character as Christians, these issues had to be resolved.

Frank Thielman: As **Wilckens** comments, “the train of thought” in **14:1 – 15:13** “is quite tight and has no major turning points.” Throughout the section Paul wants to communicate the importance of acting on questions of dietary and calendar observance in ways that are consistent with the impulses of one’s own conscience. He also desires to communicate the importance of not applying social pressure to anyone else to act against these conscientiously held convictions. Paul maintains throughout the section that people can express genuine faith in Christ in both traditional and untraditional ways (at least with respect to the faith’s connection with Judaism). It is crucial, then, for those who have chosen the untraditional path to recognize the vulnerable position of the traditionalists and to protect them against damaging their faith.

Paul provides rhetorical indicators that he treats this **single topic** in four steps.

1. The first step (**14:1–12**) begins with “*now*” (δέ) and introduces the **thesis of mutual tolerance** at common meals on the basis of deferring any judgment of others to God.
2. The second step (**14:13–23**) begins with “*therefore*” (οὖν) and focuses on the responsibility of the nontraditionalists to avoid behavior that damages the faith of traditionalists and creates division within the community.
3. The third step (**15:1–6**) begins with “*now*” (δέ) and first summarizes Paul’s exhortation to the strong in **14:13–23 (15:1)** and then urges the whole community to work sacrificially for unity with one another from the example of Christ and the teaching of Scripture (**15:2–6**).
4. The fourth step (**15:7–13**) begins with “*therefore*” (διό) and sums up both the argument of **14:1 – 15:6** and the important emphasis of the entire letter on **the unity of Jews and gentiles** who now, because of their common faith in Christ, belong equally to the people of God.

Main Idea: The nontraditionalist who eats anything and considers every day equally special should welcome and not despise the traditionalists who carefully abstain from ritually impure food and observe the Jewish calendar. The traditionalists should, in turn, avoid judging the

nontraditionalists. To the extent that either group adopts a contemptuous or judgmental attitude toward the other, that group has tried to usurp God's role as judge.

Thomas Schreiner: The theory that the weak were primarily Jewish Christians and that the strong were primarily gentile believers is the most plausible, though there were almost certainly weak gentile Christians and strong Jewish Christians. There were probably some Jews, perhaps Prisca/Priscilla and Aquila among them, who shared Paul's view and adopted the viewpoint of the strong. Conversely, it is likely that a few gentiles, perhaps some God-fearers who were attracted to Judaism, shared the scruples of the weak. On the whole, however, the weak and the strong were mainly composed of Jews and gentiles respectively.

Michael Bird: However, there is no interest on Paul's part in establishing a school of tradition to provide casuistic law for every possible moral and ritual conundrum. Paul refuses to adjudicate on the rightness or wrongness of contested topics since he regards it as a matter of personal liberty. Paul does not call for uniformity on every practice, and he can accept differences of opinion on matters that might be regarded as being of **secondary importance**. The issues of food, wine, and sacred days are obviously secondary for him. Origen summed up Paul like so: "To eat or not to eat and to drink or not drink wine is neither bad nor good itself, he teaches; it is neutral and indifferent." Paul, by taking such a position on "**disputable matters**," tries to inoculate the churches from creating an atmosphere of factious rivalry and intellectual competition.

I. (:1-3) ACCEPT FELLOW BELIEVERS DESPITE DIFFERING CONVICTIONS – Case Study #1 – Eating Meat vs Just Vegetables

A. (:1) Acceptance without Passing Judgment

1. Command

"Now accept the one"

Douglas Moo: While Paul wants both groups in the church to accept each other, he is clearly most concerned about the attitude of the strong. This probably reflects the fact that the strong, mainly Gentile Christians, are the dominant group in the church. Thus, we should not be surprised that he opens his exhortation by implicitly appealing to the strong: "*Accept him whose faith is weak.*"

2. Contrast: Weak in Faith vs. Strong

"who is weak in faith,"

Grant Osborne: Who is weak in faith, and who is strong? Every believer is weak in some areas and strong in others. A person's faith is strong in an area if he or she can survive contact with sinners without falling into their patterns. The person's faith is weak in an area if that individual must avoid certain activities, people, or places in order to protect his or her spiritual life.

Frank Thielman: "*The weak*" -- describe people who believe the gospel but who, nevertheless, do not "*believe*" (πιστεύω, **Rom 14:2**; cf. **14:22–23**) or are not "*persuaded*" (πέπεισμαι, **14:14**), that

some element of personal conduct actually permitted to followers of Christ is, in fact, permissible. . .

“*The strong*” (οἱ δυνατοί) were strong primarily because their convictions about diet and food corresponded to what was true theologically, and this theological truth had freed them from feeling any necessity to express their faith through dietary restrictions or the observance of certain days as special (**Rom 14:5–6, 14**).

Thomas Schreiner: The standpoint of the weak on foods and days, therefore, signals a certain deficiency in their faith. It is not the case, though, that the weak believed that abstaining from meat and wine and observing certain days were necessary for salvation. There is no hint that they were trying to impose these requirements on the strong for the latter’s salvation. It seems likely that they believed that one would be a stronger or better Christian if one observed their prescriptions (cf. here the comments of **Barclay** 2013: 201). As **Wright** (2002: 733) says, the weak were genuinely believers, but they had not “worked out the full implications of that faith,” and “they are people whose faith, though real, has not matured to the point where they understand its full implications.” Similar debates exist today. For instance, Sabbatarian Christians don’t usually argue that those who disagree with them are destined for eternal judgment. They merely contend that such observance is important for living the Christian life.

3. Caveat

“but not for the purpose of passing judgment on his opinions.”

Grant Osborne: This statement assumes that the church will contain differences of opinion (**disputable matters**, scruples). These kinds of disputes are not about doctrines essential to salvation, but are discussions about differences of lifestyle. Paul says we are not to quarrel about issues that are matters of opinion. Differences should not be feared or avoided, but accepted and handled with love. We shouldn’t expect everyone, even in the best church, to agree on every subject. Through sharing ideas we can come to a fuller understanding of what the Bible teaches. Our basic approach should be to accept, listen to, and respect others. Differences of opinion need not cause division. They can be a source of learning and richness in our relationships.

B. (:2) Application to Specific Cultural Issue = Dietary Convictions

1. Conviction of the Strong in Faith

“One man has faith that he may eat all things,”

2. Conviction of the Weak in Faith

“but he who is weak eats vegetables only.”

C. (:3) Analysis

1. Counsel to the Strong in Faith – Don’t Despise (Regard with Contempt)

“Let not him who eats regard with contempt him who does not eat,”

Thomas Schreiner: The admonition to **resist despising** is addressed to the strong. Such an admonition is fitting because those who are more liberal in their practices are inclined to mock and ridicule those who feel confined and restricted. Those who feel free to eat any foods and

consider every day the same tend to deride those who believe certain foods are forbidden and who think some days are holier than others. The person free from constraints finds it difficult to understand the reasons why others bridle themselves. Since it **appears irrational** to the strong, they are tempted to poke fun at and mock those who are more conservative. We see, then, that accepting the weak involves **respecting them** and holding them in honor even if there are disagreements over what is permissible.

2. Counsel to the Weak in Faith – Don’t Condemn

*“and let not him who does not eat judge him who eats,
for God has accepted him.”*

Frank Thielman: Paul’s final sentence is not directed at both groups. The continuation of concern with those who observe the law and “judge” others in **14:4** shows that Paul intends **14:3c** as an admonition to the traditionalists. They need to be reminded that the one whom God “has welcomed” (προσελάβετο, cf. **14:1**), no one else should condemn.

Thomas Schreiner: If the strong are tempted to ridicule the sensitivities of the weak, the weak tend to pass judgment on the strong, because they are convinced that the strong are sinning.

II. (:4-12) ALLOW FELLOW BELIEVERS THE FREEDOM TO BE ACCOUNTABLE TO GOD AND NOT TO US –

Case Study #2 – Observing Special Days

A. (:4) Live in Light of Personal Accountability

*“Who are you to judge the servant of another?
To his own master he stands or falls;
and stand he will, for the Lord is able to make him stand.”*

B. (:5-9) Live in Light of Conscience, Thanksgiving and Submission

1. (:5) Act Consistent with Your Conscience and Convictions

*“One man regards one day above another,
another regards every day alike.
Let each man be fully convinced in his own mind.”*

Frank Thielman: “Weak” believers among the Roman Christians observed the Sabbath and probably other special days in the Jewish calendar also because of religious conviction. They were convinced this was the right way to honor the Lord Jesus Christ (**Rom 14:5c–6**). Paul is not concerned with the absolute correctness of this position or its opposite, although he would agree with “the strong” that distinguishing between days is unnecessary (cf. **14:14; Gal 4:10; Col 2:16**). Rather, he admonishes both weak and strong to be sure that their practice with respect to the calendar is a heartfelt expression of their faith in Christ (voῖ πληροφοροεῖσθω; cf. **Rom 4:21**).

2. (:6) Act Consistent with Giving Thanks to the Lord

*“He who observes the day, observes it for the Lord,
and he who eats, does so for the Lord, for he gives thanks to God;
and he who eats not, for the Lord he does not eat, and gives thanks to God.”*

Frank Thielman: Paul now explains further the reason why he advocated tolerance on the observance or nonobservance of the Mosaic law in **14:5**. As long as each group uses their approach to the Mosaic law to express their trust in the Lord, and does so with full conviction (**14:5**) and no misgivings (**14:22–23**), then each group should feel free to continue the pattern of life they have adopted.

Thomas Schreiner: Interestingly, the central concern of Paul’s theology emerges in these verses. The very heart of idolatry is to refrain from glorifying and thanking God (**Rom. 1:21**). Paul can tolerate diverse practices that do not violate any biblical or moral norm, as long as they are motivated by the glory of God. This same theme emerges in **1 Cor. 10:31** after a long discussion (**8:1 – 10:30**) on food offered to idols. Whether eating or drinking, one must do so in order to glorify God (cf. **Calvin** 1960: 294). In **Col. 3:17** the same thought is put another way. One must do all things “*in the name of Lord Jesus, giving thanks to God the Father through him.*” “*Doing all things in the name of Jesus*” means that one does everything for his honor and praise. The text in Colossians indicates that thanksgiving to the Father is one indication that all things are being done in Jesus’s name. The connection to **Rom. 14** is illuminating, for here thanksgiving indicates whether the actions practiced are “*to the Lord.*”

3. (:7-9) Act Consistent with Submitting to the Lordship of Christ

a. (:7) Negatively: Don’t Live for Yourself

“For not one of us lives for himself, and not one dies for himself;”

Grant Osborne: We do not live in a vacuum; everything we do affects others. We need to consider our responsibility to others. We can demand freedom for ourselves, but we must also allow other believers that same freedom. If demonstrating our freedom causes us to act in an uncaring, hurtful way towards other believers, we are not yet free.

b. (:8) Positively: Live for the Lord

“for if we live, we live for the Lord, or if we die, we die for the Lord; therefore whether we live or die, we are the Lord's.”

b. (:9) Foundation for the Lordship of Christ

“For to this end Christ died and lived again, that He might be Lord both of the dead and of the living.”

Frank Thielman: Paul’s point in **14:7–9**, then, is that the believer faces every facet of existence in reference to the Lord (τῷ κυρίῳ), from the mundane question of whether to eat meat at a common meal to the momentous question of how to face death. If that is true, then it is possible to live as one who belongs to the Lord (τοῦ κυρίου ἐσμὲν) and is under the Lord’s authority (ἵνα καὶ νεκρῶν καὶ ζώντων κυριεύσῃ) in various ways. The critical thing is to observe Jewish customs, or remain free from them, as an **expression of devotion to the Lord**.

Thomas Schreiner: In all of life and even at the hour of death, the believer’s aim is to **please the Lord, to bring praise and honor to his name**. Even at death believers resign themselves to God’s will and endeavor to please him in the way they die. This conscious submission to the

Lord is based on the lordship of Christ. Both life and death are not under our control but are in the hands of the Lord, who is **sovereign** over both. As **Schlatter** (1995: 255) says, “We live ‘to the Lord’ because his judgment determines the course of life and because fulfilling his will is the purpose and goal of our life.” **Calvin** (1960: 294) makes a similar remark: “It follows from this that He has power over our life and death.” God’s sovereignty over our lives is communicated in **verse 8**: “*Whether we live or whether we die, we belong to the Lord.*” Here the genitive κυρίου (*Lord*) denotes possession. The οὖν (*oun, therefore*) connects **verse 8b** with **verses 7–8a**. The logical relationship is as follows: since believers are under the lordship of Christ whether they live or die (**v. 8b**), we live to please and honor him in both life and death. In **verse 9** the lordship of Christ is established on the basis of the two great events in his life (cf. **Acts 2:36; Rom. 1:3–4; Phil. 2:9–11**). Christ is the Lord of both the dead and living by virtue of his death and resurrection. We know that he is Lord of life and death because he has conquered death through his resurrection.

C. (:10-12) Live in Light of Ultimate Accountability

1. (:10) Accountability before God Is Inevitable

“But you, why do you judge your brother?

Or you again, why do you regard your brother with contempt?

For we shall all stand before the judgment seat of God.”

Frank Thielman: Because both weak and strong are believers, every area of their existence, whether life or death, is lived before Christ and so he alone is their judge.

2. (:11) Accountability before God Is Universal

“For it is written, ‘As I live, says the Lord,

every knee shall bow to Me, And every tongue shall give praise to God.”

3. (:12) Accountability before God Is Personal

“So then each one of us shall give account of himself to God.”

Thomas Schreiner: In the concluding verses (**Rom. 14:10–12**) Paul draws the **implications** from the lordship of Christ. Since Christ is Lord and judge, it is unsuitable for believers to judge or despise other believers (**v. 10**). All believers will stand before God’s judgment seat.

* * * * *

DEVOTIONAL QUESTIONS:

- 1) How can we determine whether a specific issue falls into the category of non-essential (disputable) or whether it is an issue we need to address with another believer?
- 2) Do we orient our life to please our Lord and Master or to please others?
- 3) Do other believers find us to be gracious and tolerant and accepting (not talking about condoning sin – we need to oppose sin) or to be legalistic and judgmental and self-righteous?

Do we always have to try to persuade others that we are “right” on every issue?

4) When are we tempted to usurp the Lord’s role as ultimate Judge of another?

* * * * *

QUOTES FOR REFLECTION:

Frank Thielman: **Romans 14:1–12** is instead an admonition to Christians to **seek practical unity** with other believers despite differences in the use, for example, of ritual, liturgy, music, the arts, the sacraments, and church organizational structure. Some ways of worshiping God are certainly more theologically sound than others, just as the theological position of “*the strong*” in Rome was more theologically sound than the position of the weak (14:14, 20). But especially where the customs of a group whose faith is vulnerable are concerned, the message of **Romans 14:1–12** is clear. As long as no fundamental theological truth is at stake, extending to them the same welcome that God extends to them (**14:1, 3**) must take priority over the assertion even of a correct theological position.

Douglas Moo: If, then, the situation in Rome is as we have suggested, Paul is addressing an issue that we sometimes call a matter of the *adiaphora* (“*things indifferent*”). The Scripture commands us to do certain things (e.g., to worship God), and it forbids us from doing certain other things (e.g., to commit adultery). But many other things are neither commanded nor prohibited—God’s people have the freedom to do them or not to do them. Should we use the King James Version of the Bible or the New International Version? Should we sing in church to an organ or with a guitar? The Bible does not say (though some Christians may think it does!).

As Paul makes clear elsewhere in his letters and in the book of Acts, he believes that Jewish Christians have the freedom to continue to observe the Mosaic law if they want to. But they must not think it is necessary for their salvation, and they cannot impose it on Gentile believers (Galatians). He also insists that believers have no obligation to continue obeying the law of Moses (see **6:14, 15; 7:4, 6**). Therefore, observing the Sabbath and other special days and avoiding meat and wine to maintain ritual purity fall into the category of the *adiaphora*.

In other words, if Christians from a Jewish background want to keep the Sabbath and abstain from meat and wine, that is fine. But if other Christians neglect the Sabbath and eat meat and drink wine, that is fine too. Both positions are “acceptable” Christian positions, and believers who hold each position should not condemn the others.

Nevertheless—and this is a vital point—we cannot extend the tolerance Paul demands here to all issues. As we have noted, he takes a different approach toward people who are violating a clear teaching of the gospel. Such people are not to be tolerated but corrected, and, if they do not repent, are to be cut off from the life of the church (see **1 Cor. 5**). We must, then, be careful to apply the tolerance of **Romans 14:1 – 15:13** to issues similar to the one Paul treats here.

Steven Cole: **Getting Along in Spite of Our Differences (:1-4)**

Here are five observations that I hope will explain and apply these verses to our church:

1. Paul is talking here about matters between believers who are all seeking to please the Lord.
2. Paul is very concerned that we believers get along with one another in spite of inevitable differences between us.
3. Paul acknowledges that there will always be differences among believers that we must learn to accept.
4. Paul is talking here about matters on which the Bible either does not directly speak or it gives room for different views.
5. To refrain from wrongly judging my brother, I must remember that God is the Savior, Sanctifier, and Lord; I'm not.

We're all prone to judge those who are different than we are. But we need to learn to accept one another and love one another in spite of our differences over minor matters where the Bible does not give specific commandments.

R. Kent Hughes: I can think of at least eleven issues on which Christians are divided today.

Moreover, none of these items are listed as taboo or sinful in Scripture (although the Scriptures give guidelines in relation to each item). These issues are:

- (1) Theater. Some Christians think they should never patronize a commercial theater. Others think they can, but that they should be selective, just as they are with the literature they read.
- (2) Cosmetics. This is not the issue it used to be, but it is controversial in certain parts of the world.
- (3) Alcohol. Alcohol is a major issue among American Christians today. Ironically, while there is growing medical evidence of its harmful physical and social effects, more Christians are exercising their freedom to partake. Hence, there is rising tension.
- (4) Tobacco. Traditionally, the Mason and Dixon Line has been the dividing line for the use and non-use of tobacco among many evangelical Christians.
- (5) Card playing. Because of its association with gambling, Christians are ambivalent about the use of traditional cards. The controversy can also include similar games, as was mentioned above.
- (6) Dancing. For some Christians this is a litmus test, especially among youth.
- (7) Fashion. Trendiness is viewed by some Christians as worldliness. Withering judgments are sometimes made both ways on the basis of clothing and hair style.
- (8) Bible translation used. In some Christian circles your translation can be a quick ticket for acceptance or rejection.
- (9) Sports. I know of young Christians who consider competitive sports sinful and ego-exalting.
- (10) Music. Today a heated controversy goes on regarding appropriate Christian music.
- (11) Material wealth. This tension is manifested in such forms as "Stop me if I'm wrong, George, but haven't you—uh, been spending a lot of money on a car?" "Nope." "No? You don't think the money could be better used, say, in the leprosy fund?"

Paul's indisputable point here is: people with opposing viewpoints on non-essentials can both be perfectly right with God. We need to take this to heart. Two of the most famous Christians in the Victorian Era in England were **Charles Spurgeon** and **Joseph Parker**, both mighty preachers of the gospel. Early in their ministries they fellowshipped and even exchanged pulpits. Then they had a disagreement, and the reports got into the newspapers. Spurgeon accused Parker of being unspiritual because he attended the theater. Interestingly enough, Spurgeon smoked cigars, a practice many believers would condemn. In fact, on one occasion someone asked Spurgeon about his cigars, and he said he did not smoke to excess. When asked what he meant by excess, he waggishly answered, "No more than two at a time." Who was right? Perhaps neither, perhaps both! Better yet would be to realize that the two could disagree and both be in the will of God.

There is a reverse truth implicit here also, which is: If the Lord convicts you that something is wrong in your life, you had better not do it, even if other Christians are doing it!

Steven Cole: There are some pastors and commentators whom I greatly respect, but with whom I differ on their understanding of **verse 5**. They argue that Paul was referring to some of the Jewish festivals, but that he could not possibly have been referring to keeping Sunday holy as the Christian Sabbath because that is a part of God's moral law, the Ten Commandments. Since God's moral law is never abrogated, Paul could not have been referring here (or in **Gal. 4:10** or **Col. 2:16**) to observing Sunday as the Christian Sabbath. They also argue that the Sabbath was a creation ordinance, stemming from God's resting on the seventh day. Thus it applies to us today.

But I find these arguments unconvincing for several reasons. First, regarding the Sabbath being a creation ordinance, there is no commandment or example of anyone before Moses' time keeping the seventh day holy to the Lord. God commanded Abraham regarding circumcision, but He never mentioned keeping the Sabbath. Although it is mentioned in **Exodus 16** (before the Ten Commandments, **Exod. 20:8-11**), the Sabbath was unique to Israel as God's covenant people.

With regard to the Ten Commandments being God's moral law, the Jews would have viewed all of the commandments in the Mosaic Law as being morally binding. They would not have divided the law into moral, civil, and ceremonial categories, as many scholars do (I formerly did so, also). For the Jew, **the law was a whole**. To reject any of it would have been unthinkable. Also, commands that we might label as "moral" are often mixed together with other laws that we might view as "ceremonial" (e.g., **Lev. 18:19 & Ezek. 18:6** in context). But the Old Testament does not label any laws according to various categories. So if we're under the "moral law," then we're under the entire law. **You can't break it up into pieces.**

But Paul is clear that we are not under the Mosaic Law as a system of relating to God (**Rom. 6:14; 7:1-6; 2 Cor. 3:6-18; Gal. 2:19; 3:10**; cf. also, **Heb. 8:6-13**). If the Sabbath commandment were still in effect, it is incredible that in writing to Gentile believers, who did not understand the Mosaic law, Paul would say (**Col. 2:16**), "*No one is to act as your judge in regard to food or drink or in respect to a festival or a new moon or a Sabbath day.*" Surely he would have put in an explanatory note, so that the Gentile Christians would not be confused. And if the Sabbath law was still binding, how could Paul have said what he says in **Romans**

14:5 without some note of clarification? In light of the strong emphasis on the Sabbath in the Old Testament, why is there not a single command in the New Testament to Gentile churches to observe Sunday as the Christian Sabbath?

Also, I have observed that when Christians emphasize keeping Sunday as the Christian Sabbath, they easily fall into the same kind of **legalism** that plagued the Jews with regard to the Sabbath. By Jesus' time, the Jews had devised all sorts of ridiculous rules about what you could and could not do on the Sabbath. Jesus often deliberately violated their rules to show them their errors and to teach that He is the Lord of the Sabbath (**Mark 2:27**). I have read well-meaning books that argue that Christians should observe Sunday as the Sabbath, but invariably they get into lists of what is permissible on Sundays: To think or talk about anything other than spiritual subjects is to violate the Sabbath. To stop by the store for a gallon of milk on your way home from church is to violate the Sabbath. **Pretty soon, we rival the Pharisees!**

Having said that, I must point out that the Lord Jesus appeared to the disciples on the first Sunday when He arose and on the following Sunday. The early Christians met on the first day of the week (Sunday; **Acts 20:7**; **1 Cor. 16:2**), arguably to testify to Christ's resurrection. The apostle John refers to "*the Lord's day*" (**Rev. 1:10**), which everyone acknowledges to be Sunday. The author of Hebrews (**10:25**) exhorts us not to forsake assembling together, as is the habit of some.

Thus there is the principle that we should regularly gather on Sunday, the Lord's day, for worship, teaching, the Lord's Supper, fellowship, and prayer (**Acts 2:42**). It's also profitable to use the Lord's day to seek and serve Him in ways that the other busy six days of the week do not allow. Set aside your normal work and chores and spend more time in the Word, in prayer, and in reading good Christian books. Visit shut-ins, have other believers over for a meal and fellowship. Do things to refresh your soul with the Lord.

But Paul allows for a measure of **freedom** on this matter. The key thing, he says (**14:5**), is, "*Each person must be fully convinced in his own mind.*" This means that you shouldn't just do what you do by habit or because everyone else does it. Rather, take the time and effort to study the Scriptures and to think it through biblically. Do what you do because you believe that it glorifies God, it's not sinful, and you're applying biblical principles to this non-essential issue as best as you can.

It's important that you not violate your conscience, because to do so is not to act in faith, which is sin (**14:22-23**). As you grow in your knowledge of the Word, your conscience becomes more informed. You will see that keeping or not keeping certain days is not the issue; rather glorifying God in all that you do is the issue (**1 Cor. 10:31**). But on these non-essential matters, don't judge your brother; judge yourself. Obey God as you understand His Word, seeking Him for more understanding

Bob Deffinbaugh: In **verses 1-12**, Paul gives us several good reasons why it is wrong for Christians to attempt to correct the convictions of other believers.

(1) **Personal convictions are private property.**

Paul wrote in **verse 5**: "*Let each man be fully convinced in his own mind.*" Again in **verse 22** we

are told: *“The faith which you have, have as your own conviction before God ...”* Paul’s point is uncomfortably clear. Mind your own business! Christian convictions are private property. We are responsible for our own convictions, but not those of our brother.

(2) Our acceptance of men into fellowship should be no more restrictive than God’s.

The strong were apparently guilty of getting together with the weak only to ‘straighten them out.’ The effect of the matter was that strong and weak Christians were not associating with one another, or accepting them. We cannot demand the other brother to conform to our convictions before we will fellowship with him simply because this would be inconsistent with the acceptance shown by God. *“Let not him who eats regard with contempt him who does not eat, and let not him who does not eat judge him who eats, for God has accepted him” (Romans 14:3)*. If God has accepted our brother, as he is, then we must do no less. We should not try to change the one God has accepted as is.

(3) A servant is accountable only to his master.

Some time ago, I was asked to preach at a Bible church in Washington State. Perhaps unwisely, I selected a topic that I knew could prove difficult for some to accept. I told the pastor before the sermon that my message might prove a little difficult. I’ll never forget the response of that man of God. “You’re the Lord’s servant, brother, not mine.”

Brad Barrett: Accept One Another

Even though Paul understands the Bible permits eating anything, he doesn’t really focus on that at all. This is surprising to me. I read this and I wonder, “Paul, why don’t you tell us that the strong way is the right way? Why don’t you make a bigger deal about correcting our thinking about the food?”

What is Paul’s emphasis? Here’s his emphasis....Here is the main point for today: All of you...strong or weak...stop judging one another. Stop despising one another. Stop quarreling about these matters. God is our JUDGE. We are NOT. Instead of criticizing, WELCOME each other (vs. 1). ACCEPT each other. Receive them like a brother and a sister. Be friendly towards them. Have intimate fellowship with them.

Then he hits us all with this: If God has WELCOMED and ACCEPTED and is FRIENDLY your brother and sister in Christ, who are we to not do the same? Who do we think we are? Why are we judging harshly our brother whom Christ has received and welcomed?

What does this condemning, despising, critical attitude look like?

It may look like this:

- Anger
- Rolling our eyes
- Shake our head
- Look down upon them.
- Mock
- Feelings of superiority
- Argue with them.

<https://stonebrook.org/sermons/romans-141-12-accept-one-another/>

Leedy Greek NT Diagrams:

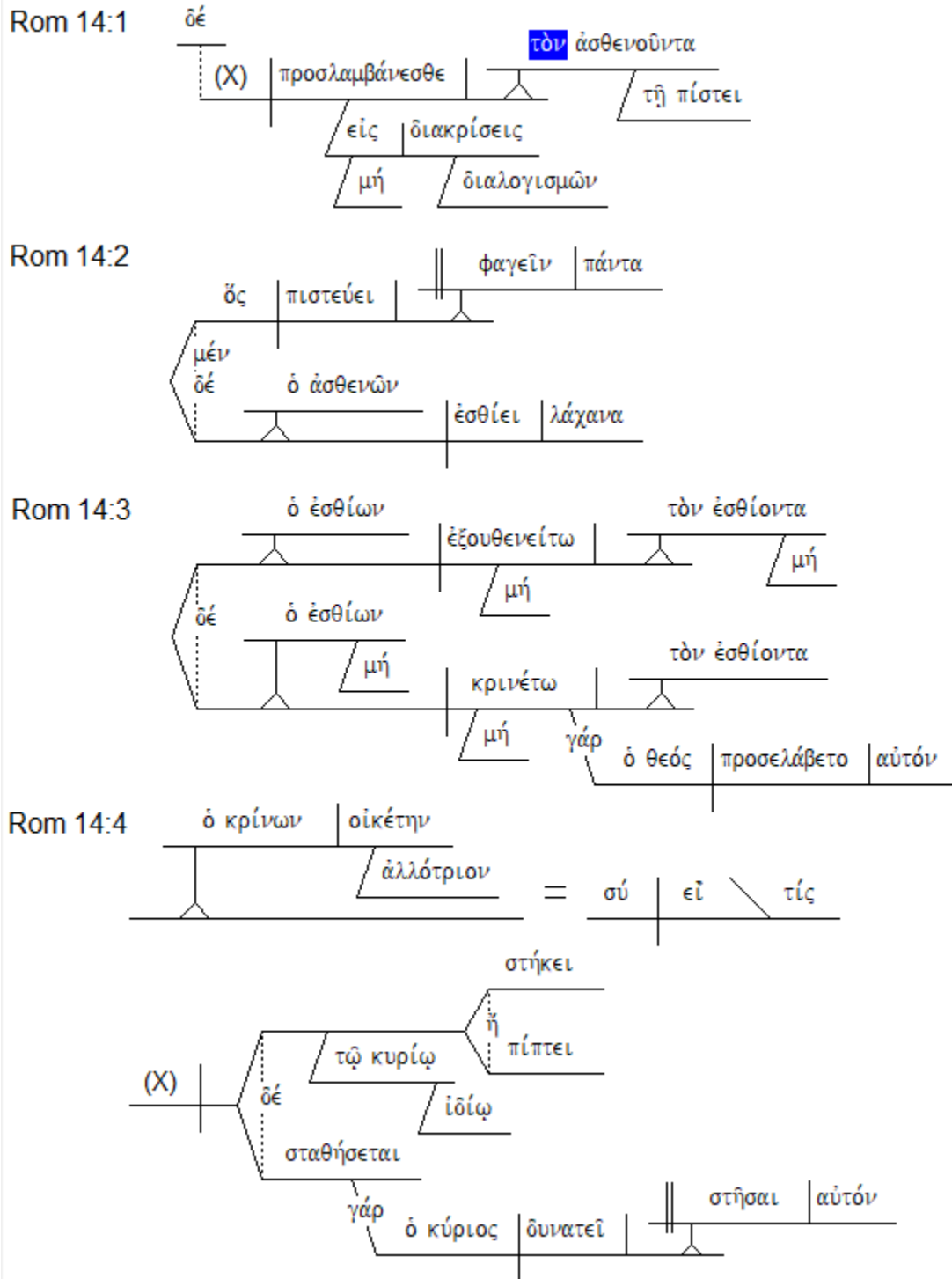

Rom 14:5

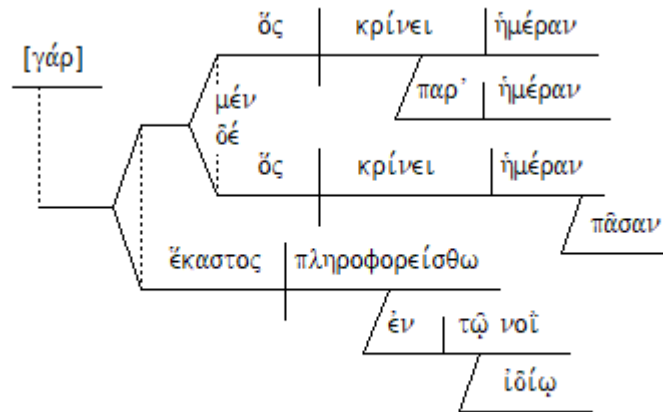

Rom 14:6

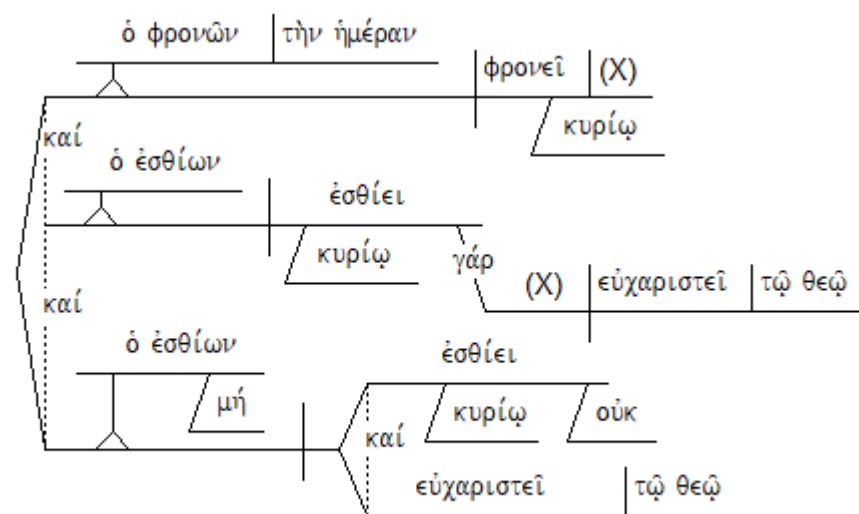

Rom 14:7-8

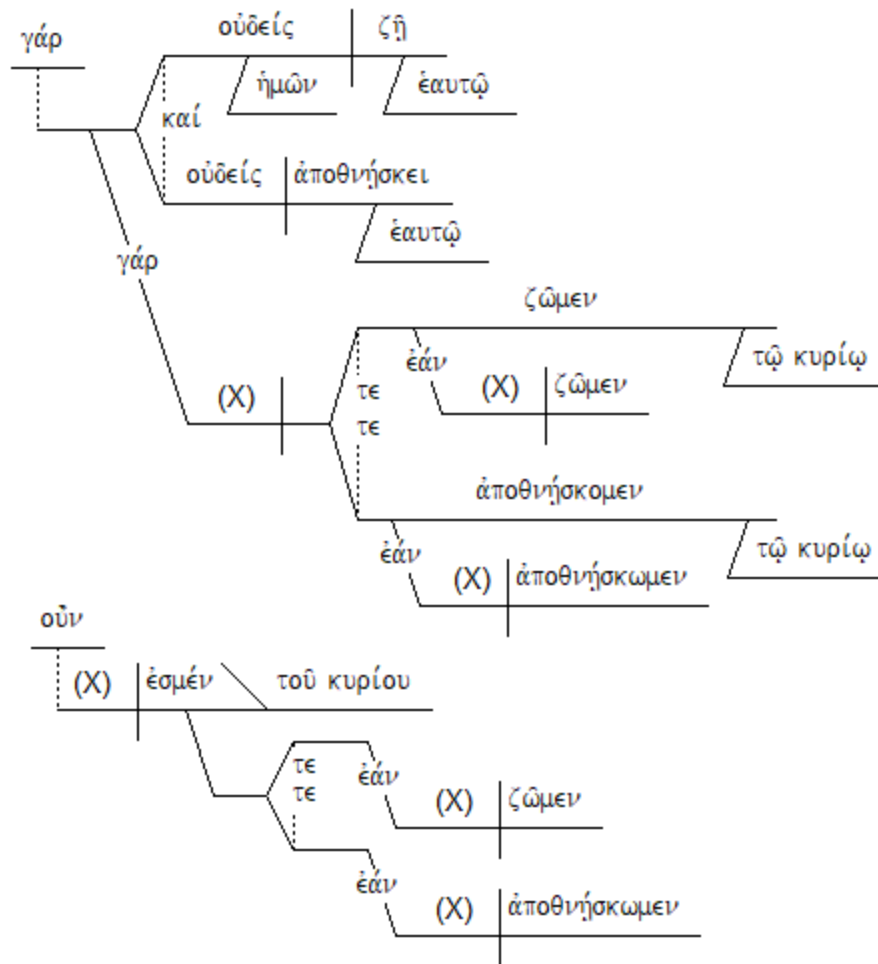

Rom 14:9

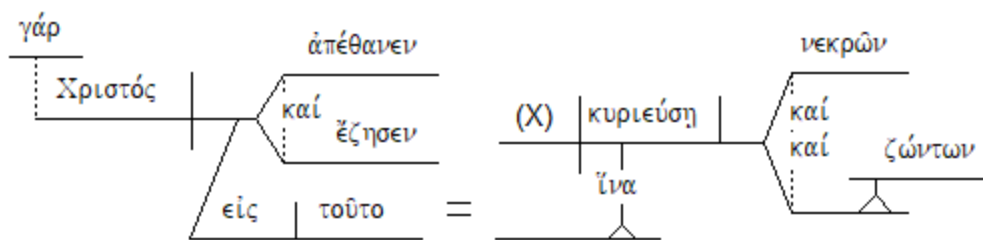

Rom 14:10-11

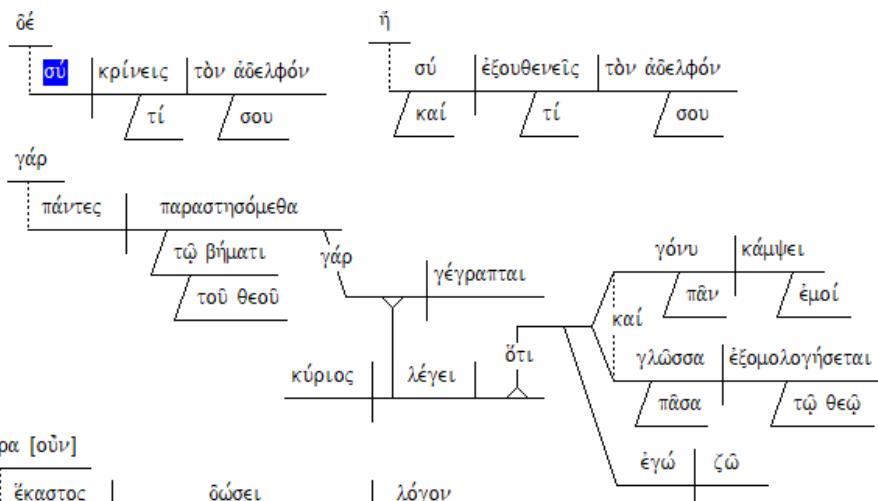

Rom 14:12

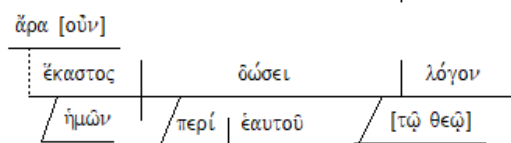

Frank Thielman:

- 1a Exhortation **Now welcome the one who is weak in faith, but**
 b Expansion (of 1a) not with the result of divisions caused by arguments.
- 2a Description **One person believes in such a way that he or she eats everything,**
 b Contrast (to 2a) **but the weak person eats vegetables.**
- 3a Exhortation **Let the one who eats not hold the one who does not eat**
 in contempt,
 b Exhortation **and let the one who does not eat not judge the one who eats,**
 c Basis (of 3a–b) **for God has welcomed him or her.**
- 4a Rhetorical Question **Who are you, you who judge another’s household servant?**
 b Assertion **He or she stands or falls with respect to their own master,**
 c Assertion **and that person will stand,**
 d Basis (for 4c) **for the Master is able to make them stand.**
- 5a Assertion **One person chooses one day over another,**
 b Contrast (to 5a) **but another person esteems every day.**
 c Exhortation **Let each person be fully convinced in his or her own mind.**
- 6a Assertion **The one who gives special regard to a particular day does so for the Lord;**
 b Assertion **and the one who eats does so for the Lord,**
 c Basis (same as 6e) **for he or she gives thanks to God;**
 d Contrast (with 6b) **and the one who does not eat does so for the Lord,**
 e Basis (same as 6c) **and he or she gives thanks to God.**
- 7 Basis (for 6) **For no one lives to oneself, and no one dies to oneself.**

- 8a Basis (for 7) For **just as we live to the Lord**
- b Condition if we live,
- c Correlation **so also we die to the Lord**
- d Condition if we die.
- e Inference (from 8a) So, then,
- f Condition/Alternative if we live and if we die,
- g Assertion **we are the Lord's.**
- 9 Basis (for 8b) For **this is the reason Christ died and lived:**
that he might rule as lord over both the dead and the living.
- 10a Rhetorical Question But you, **why do you judge your brother or sister?**
- b Rhetorical Question Or you too, **why do you hold your brother or sister in contempt?**
- c Basis (for 10a–b) For **we will all stand**
Location before the tribunal of God.
- 11a Verification (of 10c) For **it is written,**
"As I live," says the Lord, "every knee will bow to me and every tongue [☩]
will praise God." (Isa 45:23)
- 12 Inference (from 11a) So, **each of us will give an account**
Content of himself or herself to God.

TEXT: ROMANS 14:13-23

TITLE: LOVE TRUMPS LIBERTY

BIG IDEA:

IN ISSUES OF PERSONAL CONVICTION, LOVE MUST TAKE PRECEDENCE OVER LIBERTY TO PROMOTE PEACE AND PREVENT STUMBLING BLOCKS

INTRODUCTION:

Frank Thielman: Paul has just explained in **14:1–12** that neither the weak nor the strong should “judge” one another, and now he shows specifically what this means for the strong and why it means this. The strong must “decide” not to damage the faith of the weak with respect to their traditional dietary practices by putting social pressure on them to eat food they consider forbidden. If the strong, by their contempt and example, lead the weak to eat food they consider ceremonially impure, they will at least create *distress* (λυπεῖται, **14:15**) for the weak and at worst *destroy* (ἀπόλλυε, v. **15**) and *tear down* (κατάλυε, v. **20**) their faith.

Main Idea: Those who see no need to avoid ceremonially impure food at the common meal of believers should not hold those who refrain from such food in contempt, nor should they put their own, less scrupulous convictions on display at these meals. The faith of the weak is vulnerable because they could be shamed into eating certain foods against their own convictions, and doing this could tear down their faith. The strong, then, should show love and a willingness to preserve the peace of the community by keeping their own convictions to themselves when the community meets

R. Kent Hughes: Exercising Christian liberty is very much like walking a tightrope. As you walk the rope with balancing pole in hand, at one end of the pole is **love for others** and at the other is **Christian liberty**. When these are in balance, your walk is as it should be. **Martin Luther** had it right when he began his treatise “*On the Freedom of a Christian Man*” by saying, “A Christian man is a most free lord of all, subject to none. A Christian man is a most dutiful servant of all, subject to all.” We are all immensely free in Christ. Our only bondage is the bond of love to our fellow believers.

It is our Christian duty, when exercising our freedom, not only to think about how our actions affect us but others. We must always remember that it is not our display of Christian freedom that commends our faith to the world, but our demonstration of agape love. Jesus said, “*By this all people will know that you are my disciples, if you have love for one another*” (**John 13:35**). The strong, mature Christian voluntarily limits his freedom out of love for his weaker brothers and sisters.

Grant Osborne: Interdependence -- Sin is not just a private matter. Everything we do affects others, and we have to consider the **impact** of what we do. God created us to be interdependent, not independent. We who are strong in our faith must, without pride or condescension, treat others with love, patience, and self-restraint. Nothing like food should be so important to us that we insist on having it even at the risk of harming another.

I. (:13) LOVE REPLACES JUDGMENT WITH BROTHERLY SENSITIVITY

A. Don't Judge Your Brother for His Personal Convictions

“Therefore let us not judge one another anymore,”

B. Don't Exercise Your Liberty in a Way that Trips Up Your Brother

“but rather determine this—

not to put an obstacle or a stumbling block in a brother's way.”

Steven Cole: Paul uses a play on words here: the word translated “*determine*” is the same word translated “*judge*” earlier in the sentence. We might paraphrase, “Don’t judge your brother; rather, judge yourself so that you don’t put an obstacle or stumbling block in your brother’s way.” Keep in mind that in this chapter, Paul is talking about *non-moral* matters where the Bible does not give clear commands. He is not talking about judging your brother regarding sin or serious doctrinal error (which we need to do), but rather on non-moral or secondary matters.

II. (:14-18) LOVE KEEPS THE MAIN THING THE MAIN THING

A. (:14) Respect Differing Personal Convictions

“I know and am convinced in the Lord Jesus that nothing is unclean in itself; but to him who thinks anything to be unclean, to him it is unclean.”

Frank Thielman: The perfect-tense, first-person verb translated “*I am persuaded*” (πέπεισμαι) was common in expressions of an opinion that was strongly held (e.g., **Acts 26:26; 2 Tim 1:5**; cf. **Phil 1:6; Heb 13:18**). Paul intensifies it further by coupling it with “*I know*” (οἶδα). He is convinced of his position either because he knows and believes the teaching of Jesus on clean and unclean foods (**Mark 7:15, 18b–19**), or in a more general sense because the resurrected and exalted Lord had revealed to him that the Mosaic dietary laws no longer needed to be observed. Paul’s references elsewhere to being persuaded of something “*in the Lord*” make this general sense more probable (cf. **Gal 5:10; Phil 2:24; 2 Thess 3:4**; cf. **Phil 1:14**).

B. (:15) Restrict Your Liberty to Avoid Harming Your Brother

“For if because of food your brother is hurt, you are no longer walking according to love. Do not destroy with your food him for whom Christ died.”

Frank Thielman: To force the weak brother or sister into a corner on the issue of food by exuding an attitude of contempt for that person (**14:3, 10**) is to fail to live *according to* (κατά) the all-encompassing standard of sincere love that fulfills the law and should characterize the day-to-day life of every believer (**12:9; 13:10**).

Steven Cole: While I greatly respect these scholars who say that the word *destroy* here means **eternal destruction** and I agree with some of the arguments that they put forth in other contexts, it seems to me that the context here overrides the usual meaning of the word and that here Paul means that flaunting your liberty will **damage** your brother’s walk with God, not that you will cause a professing believer to go to eternal damnation. It’s still a serious matter—we shouldn’t

minimize how bad it is to hurt a brother's walk with God. But I think that it goes too far here to insist on the usual meaning of *destroy*. . .

It is difficult to extrapolate the principles that Paul sets forth here into modern situations. The first thing to determine is whether the Bible speaks directly to the situation. If so, obey what it commands. If not, don't think first about your rights to liberty. Rather, think about your weaker brother's spiritual growth. **Love trumps liberty**. Love says, "My liberty is no big deal. The big deal is that my brother grows in his walk with Christ."

C. (:16) Regard the Impact of Your Behavior

"Therefore do not let what is for you a good thing be spoken of as evil;"

Thomas Schreiner: The specific meaning of verse 16 is controversial, but if the οὐν (*oun*, therefore) is original (and it probably is), then it draws an inference from **verses 13–15**. The logic between the two sections seems to be this. If the strong act contrary to love and bring ruin on the weak (vv. 13–15), then the weak will criticize "*the good*" (i.e., the faith that gives the strong the freedom to eat; v. 16).

D. (:17) Remember the Essentials of the Kingdom

*"for the kingdom of God is not eating and drinking,
but righteousness and peace and joy in the Holy Spirit."*

Steven Cole: **Keep the main thing the main thing.** . . Having healthy, godly relationships that flow from our relationship with God is the main thing. You can win arguments about theology, but shred relationships. You're off track. You can prove that you're right and your mate is wrong, but you're off track. You can take pride in what you do for the Lord, but you're off track. The main thing is God's kingdom, where He rules and you submit. God's kingdom centers on your relationship with Him and with others. Keep that as the main thing!

Michael Bird: Paul rarely mentions the "*kingdom of God*," and when he does he ordinarily has in mind the future state that God's people are yet to enter (see **1 Cor 4:20; 6:9 – 10; 15:24, 50; Gal 5:21; Eph 5:5; Col 1:12 – 13; 4:11; 1 Thess 2:12; 2 Thess 1:5; 2 Tim 4:1, 18**). Here, though, Paul emphasizes the realized or **present dimension** of the kingdom of God. The kingdom is manifested in their midst by the Holy Spirit, who bestows on them the blessings of righteousness, joy, and peace. **Brian Vickers** comments, "By placing personal freedom, here in the form of eating and drinking, above the good of others, they are forgetting how they received the kingdom and what should mark those who belong to it." When one realizes what the kingdom is and how the kingdom is expressed among them, petty squabbles over meat and sacred days appear comparatively pointless and even pitiful.

R. Kent Hughes: We are prone to think that the Kingdom of God primarily involves what a person does or does not eat or drink, or what he wears, or what he does or does not do on the Lord's day, or how he combs his hair or does not. This is how the Pharisees lived, making a big deal of **externals**. But the Kingdom of God is not mainly a matter of externals but of **eternals**—"righteousness and peace and joy in the Holy Spirit." Paul's words and their inspired arrangement are supremely beautiful and truly spectacular.

The primary eternal element of God's Kingdom is "*righteousness*." The experience of God's righteousness in our lives produces an infinite longing for holiness, a driving desire to know him better, an intense thirsting in the inner parts. David's longing is expressed in **Psalm 42:1, 2a** ;

*As a deer pants for flowing streams,
so pants my soul for you, O God.
My soul thirsts for God, for the living God.*

Jesus enjoined the pursuit of righteousness as the recommended pursuit for all humanity in **Matthew 5:6**—"Blessed are those who hunger and thirst for righteousness, for they shall be satisfied."

Properly following the eternal element of righteousness is "*peace*," that profound inner satisfaction that only God's presence can give. Peace with God is the secret of peace with one another. Kingdom peace is an inner unflappability that remains undisturbed by minor irritations, a quiet assurance that God is at work.

Lastly, there is the eternal element of "*joy in the Holy Spirit*." This joy is the outward mark of Christ's presence. Once when my wife and I were visiting London, we took a walk with a friend after dinner past St. James Place, and he remarked that the Queen Mother was at home because her banner was flying. When joy flies as the flag over our lives, the world knows the King of Heaven is in residence in our hearts.

E. (:18) Receive the Approval of God and Men

"For he who in this way serves Christ is acceptable to God and approved by men."

Frank Thielman: If the strong use their strength to live out the principles of righteousness and peace in their relationships with the weak, they will be presenting their bodies as living sacrifices to God and providing an attractively peaceable character to everyone, including their unbelieving neighbors.

Thomas Schreiner: Verse 18 functions as an explanation (ἐν τούτῳ, *en toutō*, *in this*) of verse 17. Those who live kingdom lives are pleasing to God and receive approval from other people.

III. (:19-21) LOVE SACRIFICES LIBERTY FOR HARMONY AND EDIFICATION

A. (:19-20a) Seek Harmony and Edification

1. (:19) Commanded Positively

*"So then let us pursue the things which make for peace
and the building up of one another."*

Michael Bird: The believers in Rome, despite their diversity, despite the complexity of the relationship between Christ-believing Jews and Gentiles over the last several years, and despite their personal grievances and wounds, they are to pursue peace and mutual upbuilding. The things that make for peaceful relationships, harmony, and consensus, those are the things they

are to doggedly chase after. Instead of destroying God's work in his servants, they are to build each other up, like adding another spiral to a beautiful cathedral. Paul wants a cessation of hostilities and a combined effort to create an atmosphere of mutual support.

Douglas Moo: The strong ought to be more concerned about the growth of the body as a whole rather than their own freedom and spiritual advancement.

James Dunn: The more liberal must be conscious of their responsibility not only to the conservative individual, and not only before the wider public, but also to the congregation itself. To press home his point Paul draws on two concepts of rich connotation for him. To be a responsible member of the body of Christ in Rome means actually working for "*peace*"—that is, once again, not merely an absence or avoidance of friction or antagonism, and not merely an individualistic quietness of mind, but a positive well-being which covers the whole range of spiritual and social relationships. It means also striving to "*build up*" the mutual relationships of which the church consists (the polar opposite for Paul of a spirituality or worship or fellowship which seeks first and foremost its own benefit and advancement). To belong to God's building means living out one's life as part of that building, mutually dependent on God's grace and mutually interdependent on the interlocking relationships by which the building exists and grows. Despite their greater sense of liberty, the strong are more dependent on the weak than they might at first realize.

2. (:20a) Commanded Negatively

"Do not tear down the work of God for the sake of food."

B. (:20b) Stumbling Your Brother is an Evil

"All things indeed are clean, but they are evil for the man who eats and gives offense."

C. (:21) Self Restraint is a Virtue

*"It is good not to eat meat or to drink wine,
or to do anything by which your brother stumbles."*

John Toews: Nothing is ritually unclean by itself. Old lines for demarcating the holy and the unholy, and thus those who are "in" from those who are "out," no longer apply. The more expansive believers can and should rejoice in their theological and spiritual freedom. True faith means freedom, and freedom involves diversity. But the exercise of freedom must be conditioned by love, by the effect the freedom has on believers whose faith is less expansive and can be injured or even ruined by the public display of freedom by others.

IV. (:22-23) LOVE DOES NOT PRESSURE OR COMPROMISE IN AREAS OF PERSONAL CONVICTION

James Dunn: Paul has thus expressed with some care his double concern regarding his more conservative readership's continued sense of obligation to the older and clearer boundary markers and rules of conduct for the people of God provided by the traditional Jewish customs: the concern that conservatives should not assume that God's saving righteousness was still

dependent on these rules and rituals and so condemn nonobservers as “beyond the pale” (vv 3–12); and the concern that the more liberal majority should not ride roughshod over these sensibilities and should appreciate how firm a hold they had on their more conservative fellows and how vulnerable that left them (vv 13–21). The balance was a difficult one to maintain between **Christian liberty** and **love**, and Paul must have been conscious of how easily the full range of liberty can lapse into **legalism** at one end (cf. 10:3), just as easily as it can lapse into **licentiousness** at the other (13:13). So he makes one final summarizing attempt to set the proper balance for any congregation where fundamental disagreements exist between members—a kind of **charter of Christian liberty**.

Basic is the recognition that **liberty arises out of faith**. The recall of this motif, so central for Paul’s exposition as a whole, is no accident. For Paul’s point is precisely that the “*strong*” have recognized (at least in the matter of foods and sabbaths) that conduct must arise directly out of and as an expression of their unconditional trust in and dependence on God, and not as a claim upon God. This is the danger which the “*weak*” are ever prey to, the mistake into which Paul’s fellow Jews had fallen in their boastful reliance on the distinctive Jewish “*works of the law*” (2:17–29; 3:27 - 4:2). But equally, **liberty must be conditioned by love**, for a liberty careless of its effects on others is an expression more of self-indulgence than of faith. This is the danger which the “*strong*” are ever prey to, the mistake characteristic of fallen humanity at large, as indicated in 1:18–32. Here the importance of seeing faith in experiential terms, as a (usually) **conscious dependence on God**, and not simply as mental assent to a creedal definition, should not be lost sight of.

Basic too is the recognition that **liberty means diversity**, that Christian liberty is a spectrum embracing a range of options, not all of which can be held by any single person, but all of which may be held within a Christian congregation without destroying its unity. **Chapter 14** is therefore the outworking in terms of conduct of Paul’s understanding of the congregation as the body of Christ (12:3–8). Unless there is an acceptance along that spectrum of the different possibilities within that spectrum, there can be no real liberty. So even when Paul is addressing his remarks primarily to the “*strong*,” he does so no doubt fully conscious of the presence of the “*weak*” in the same congregations, and with a view to encouraging them to accept that different practice is possible without transgressing the faith which unites them all.

A. (:22a) **Personal Convictions Should Govern Your Behavior, Not Pressure Others**

“The faith which you have, have as your own conviction before God.”

Frank Thielman: Paul uses the phrase “*before God*” (ἐνώπιον τοῦ θεοῦ) elsewhere to emphasize the importance of **sincerity** and **truthfulness** before God, who has an infallible knowledge of everyone’s thoughts and intentions (e.g., 2 Cor 4:2; 7:12; Gal 1:20; 2 Tim 4:1), and that is also the emphasis here. Paul’s point is that it is enough for the strong to know in all sincerity that their position on the matter of observing Jewish customs is correct (**Rom 14:14**). They do not have to express their position at the expense of other believers by eating food forbidden by the Mosaic law at the believing community’s common meals. The strong can happily eat anything at home since the gospel has equipped them with renewed minds capable of exercising discernment and of *approving* (δοκιμάζειν) their own actions as God’s will (12:2).

Thomas Schreiner: Verse 22 functions as a clarification. The self-denial of the strong should not be understood as an assault on or criticism of their theology. They are free to maintain the convictions of their faith in the privacy of their home or with other believers of like convictions. Furthermore, the strong are truly blessed by God in that they are undisturbed by doubts in eating whatever they wish (v. 22b).

B. (:22b-23) Personal Convictions Should Not Be Compromised

1. (:22b) Good Conscience Enhances Happiness

“Happy is he who does not condemn himself in what he approves.”

2. (:23) Bad Conscience Exposes Sin

“But he who doubts is condemned if he eats, because his eating is not from faith; and whatever is not from faith is sin.”

* * * * *

DEVOTIONAL QUESTIONS:

- 1) What makes this chapter so difficult for us to interpret and apply in today’s culture?
- 2) Are we able to exercise self-restraint when it comes to the expression of our Christian liberty?
- 3) Where do we tend to judge other Christians for their living out of their personal convictions?
- 4) Where have we majored on some soapbox issue that caused unnecessary division in our Christian circle?

* * * * *

QUOTES FOR REFLECTION:

Frank Thielman: In **Romans 14:13–23** Paul helps us to understand that the priority of building up the strength of the other person’s trust in God must take precedence over our own freedom of expression. It may certainly be necessary for another person’s edification to speak to him or her a truth that challenges them in uncomfortable ways, but even in these moments believers should *speak the truth in love (Eph 4:15)*. The goal of this truthful, edifying speech should always be building up rather than tearing down the other person’s faith in God.

Whether the issue is admission to the Lord’s Supper, who should be baptized, the method of baptizing, what constitutes ordination, who can be ordained, divorce and remarriage, the relationship between Scripture and church tradition, or a host of other ecclesial bones of contention, this passage teaches that decision makers in the church should conduct themselves with charity and patience toward believers who differ from them. As they teach the truth, they should refuse to engage in unloving and coercive tactics that damage the faith of others and

should instead, as Paul puts it in Ephesians, be “*eager to maintain the unity of the Spirit in the bond of peace*” (Eph 4:3).

Michael Bird: Perhaps one of the greatest lessons that this text has for us is that when it comes to **secondary matters**, Paul shows that it is **more important to be loving than to be proven right**. There is no gain to be made in proving that one’s theology of kashrut laws or the Sabbath is theologically superior if it means fostering division and denigrating the convictions of another. You might win the argument or impress like-minded peers, but you lose a brother or sister for whom the Messiah died. And if the Messiah is for them, crucified for them, to wash away their sins and yours, how can you seek to bring them to spiritual ruin? **Paul does not insist that the strong have to agree with the weak, but he does insist that they constrain the exercise of their freedom to promote love, peace, and unity**. For the Christians in Rome, where their faith is exercised in a context of hostility and daily uncertainty, they do not have the luxury of dividing over miniscule matters about morsels of meat, since far more is at stake than steak.

Michael Gorman: The liberal actions that flow from one’s convictions about nonessential matters such as food and drink are not sinful and are accepted by God as long as they are done in faith (i.e., as an expression of loyalty to one’s Lord; 14:22–23). The rationale for such convictions is a matter of individual conscience before God (14:22). But acting on those convictions must be curtailed if doing so could do serious harm to a brother or sister, or to the community at large. Each individual should have a firm “faith”—meaning conviction—about nonessential matters and therefore not eat, for instance, with qualms just because others are eating. That would be sin (14:23), because it does not proceed from faith, or faithfulness: single-minded devotion to one’s Lord.

As Jesus said (and Paul seems to have known this part of the Jesus tradition too), evil is a matter of which actions proceed from the heart, not which foods go into the belly (Mark 7:20–23). Similarly, by implication, the mark of God’s people is the love that comes from the circumcised heart of the renewed covenant, not the cultural food laws and other previous boundary markers. Neither practicing nor refraining from such cultural practices is essential to Christian faith. To paraphrase Paul’s words to the Galatian communities, neither vegetarianism nor omnivorism is anything; but a new creation is everything! (see Gal 6:15).

Douglas Moo: **TRADITION!** Tevye’s famous cry “Tradition!” in *Fiddler on the Roof* embodies an attitude shared by almost all people in every century. All of us have certain traditions we maintain that serve to link us with past generations and to bind us tightly with other people in our own social or religious group. We often do not even know where such traditions come from. I am reminded of a story my pastor, **Todd Habegger**, tells. In a family he knows, a ham always had an inch or so sliced off from one side before it was put in the oven. He asked why this was done. The woman cooking the ham replied, “Because my mother always prepared ham that way.” With her interest stimulated, she in turn asked her mother about the ham. Her mother said, “Because my mother always prepared ham that way.” When she then asked her great-grandmother about it, she laughed and explained: “The oven in our first home was so small that a whole ham would not fit into it. So I had to cut off part of it.”

Most of us probably have better reasons to maintain traditions. But, understandable or not, we all have them, and they have great value in giving us a sense of identity. We understand the issues in **Romans 14** and their application to our own day better by fully recognizing the **power of tradition**. The Jews who lived in Rome in Paul's day were especially in need of identity-reinforcing traditions. They were a minority religious group trying to survive and preserve their identity in the midst of a pluralistic and often hostile environment. Like many other Jews in the centuries after the Exile, they put great emphasis on some of the religious traditions that helped to preserve their identity and to keep them separate from the world around them.

Faced with both persecution and dispersion, Jews magnified Old Testament-based traditions such as circumcision, the avoidance of unclean food, and the observance of ritual days, especially the Sabbath. We should not, therefore, be surprised that it was just these issues that repeatedly surfaced as points of tension between many Jewish Christians and Gentile Christians. Theology, of course, played a big role. The group of Jewish Christians known as Judaizers, for instance, argued that God's covenant with Abraham and its subsequent restatement under Moses made circumcision and obedience to the law essential components of what it meant to belong to God. Paul disagreed, as he reveals in Galatians.

But other Jewish Christians undoubtedly approached these issues from less of a theological or even theoretical perspective. They had been taught by parents and peers that certain practices were essential for all good Jews. Their acceptance of Jesus as their Messiah expanded their horizons, revealing to them that God had brought about a new era in salvation history in which Gentiles could join with them in worshiping the one true God. And, unlike the Judaizers, many of them acknowledged that the Gentiles did not need to follow those customs peculiar to Jews. Yet they had a hard time understanding why they personally should not continue to follow the rules they had been taught since childhood.

Even those who agreed in theory that the rules were no longer necessary probably had difficulty discarding what was so integral to their cultural and religious identity. These were traditions, and it is not always easy to throw them overboard, however persuasive the arguments for their abandonment might be. From his own background Paul knew well how powerful tradition was among the Jews. He sympathized with Jewish Christians who found it difficult to abandon overnight what was so ingrained in them. Thus, he wants the other Christians in Rome to "**cut them some slack.**"

Steven Cole: The content is arranged in a loose **chiastic** (ABCC'B'A') format (**Douglas Moo**, *The Epistle to the Romans* [Eerdmans], p. 850, points this out, although I've expanded his analysis somewhat).

A: **14:5:** Be fully convinced in your own mind.

B: **14:13:** Don't put a stumbling block in your brother's way.

C: **14:14:** Nothing (no food) is unclean.

D: **14:15:** Do not destroy your brother.

E: **14:16**: Do not let your good (liberty) be spoken of as evil.

F: **14:17**: The kingdom of God is ... peace.

F': **14:19**: Pursue the things that make for peace.

E': **14:20**: Your clean food becomes evil if you hurt a brother.

D': **14:20**: Do not tear down the work of God.

C': **14:20**: All things indeed are clean.

B': **14:21**: Don't do anything by which your brother stumbles.

A': **14:22**: Have your own conviction before God.

Leedy Greek NT Diagrams:

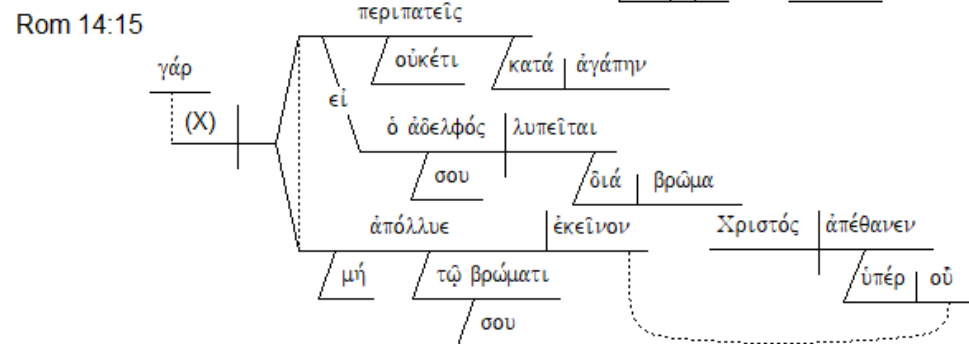
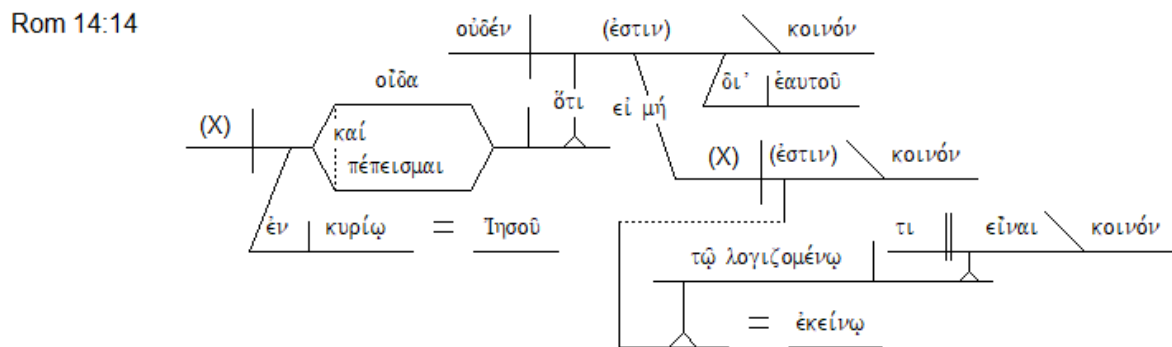
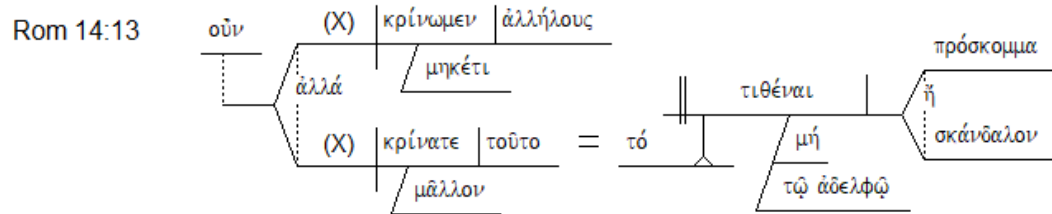

Rom 14:16

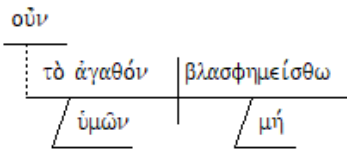

Rom 14:17-18

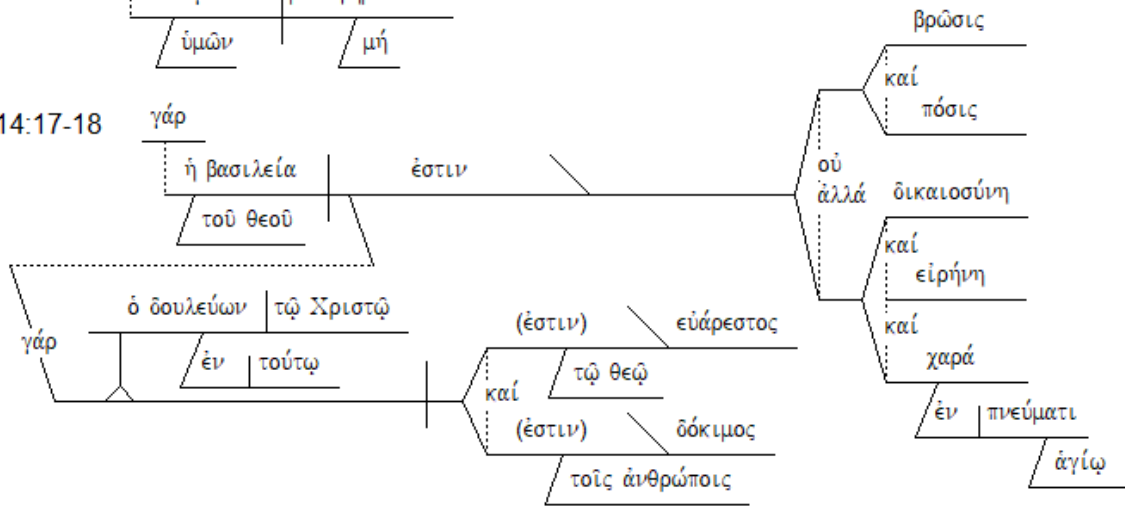

Rom 14:19

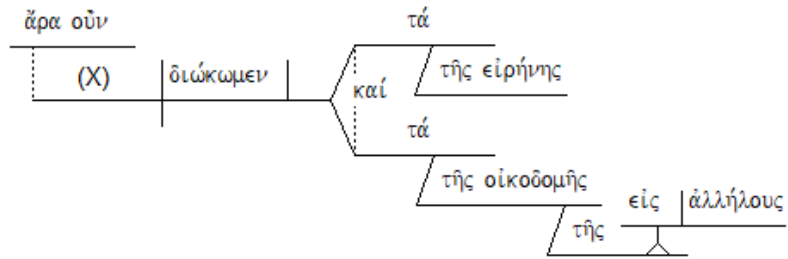

Rom 14:20

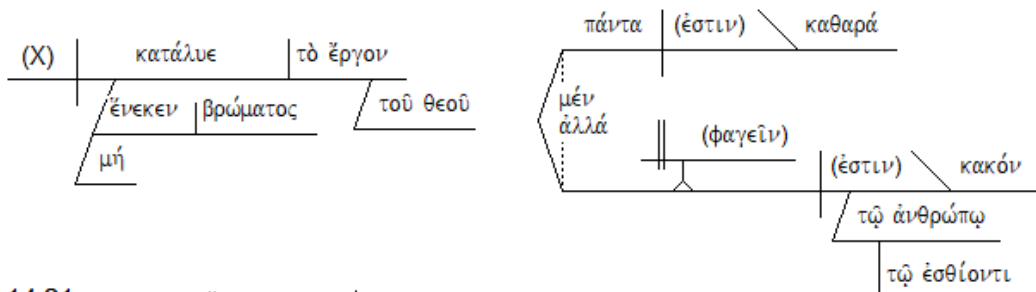

Rom 14:21

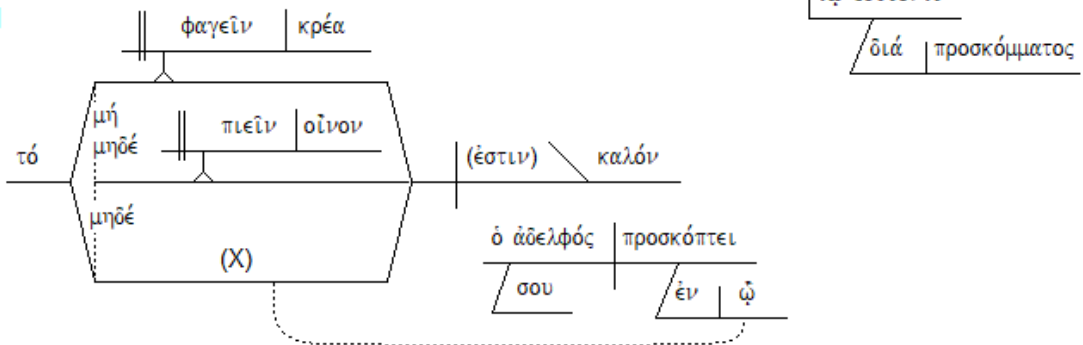

Rom 14:22-23

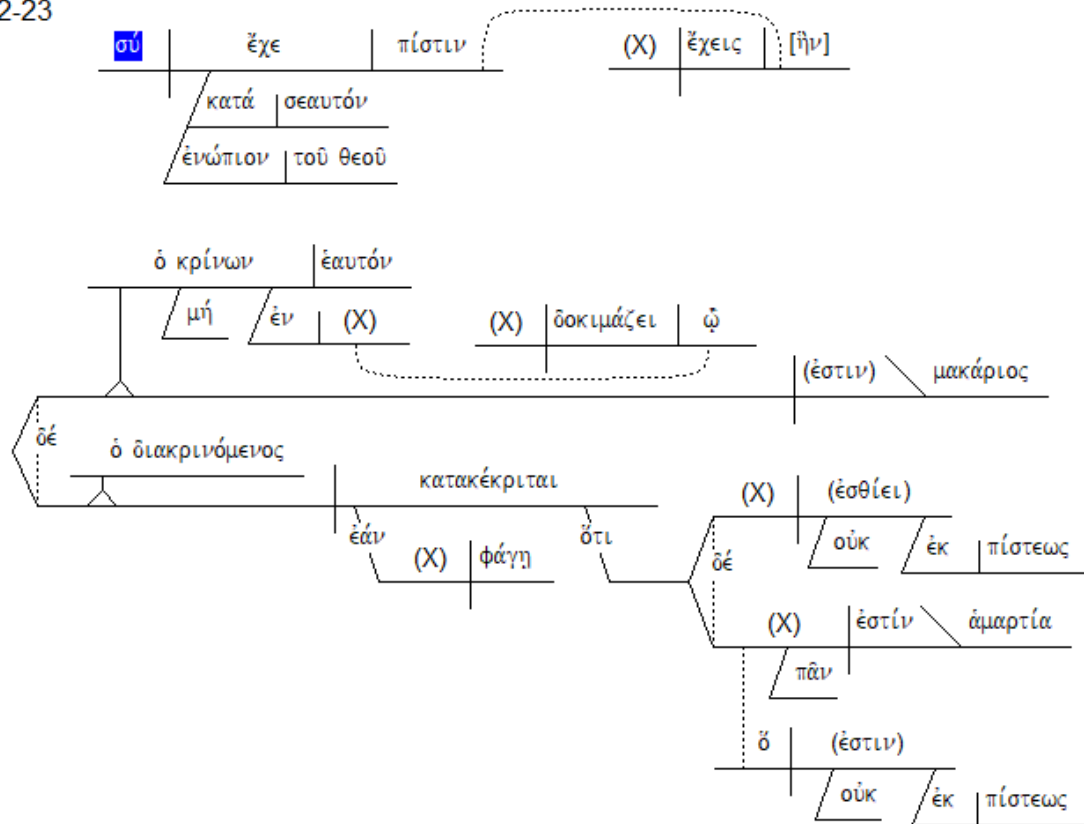

Frank Thielman:

- 13a Exhortation Therefore **let us no longer judge one another.**
- b Contrast (to 13a) But instead, **decide this:**
c Content not to place an obstacle or
d a stumbling block in the way of a brother or sister.
- 14a Assertion **I know and**
b **am persuaded** in the Lord Jesus
c Content that nothing is ceremonially impure in itself,
- d Concession (to 14a) but
e Identification to the one who reckons something to be ceremonially impure,
f Restatement to that one
g Assertion **it is impure.**
- 15a Condition For if, on account of food, your brother or sister is distressed,
b Assertion **you are no longer walking in love.**
- c Exhortation **Do not destroy that person**
for whom Christ died
in preference to your food.
- 16 Exhortation **Do not, therefore, let the good thing that is yours become the object of slander.**
- 17a Explanation For **the kingdom of God is not eating and drinking** but
b Contrast **righteousness and peace and joy** in the Holy Spirit.
- 18a Explanation (of 17) For **the one who serves Christ in this is pleasing to God and**
b Contrast **respected among human beings.**
- 19 Summary (of 13–18) So then, **let us pursue peaceful things and things that edify one another.**
- 20a Exhortation **Do not tear down the work of God**
b for the sake of food.
- c Explanation (of 20a) **Everything is clean,**
d Contrast (to 20c) but to the person who eats as a result of stumbling,
it is evil.

- 21a Assertion **It is good**
 b List not to eat meat or
 c List to drink wine or
 d List to do anything by which your brother or sister stumbles.
- 22a Exhortation As for you, **hold the faith that you hold**
 b to yourself
 c before God.
- d Basis (of 22a) **Happy is the one who does not judge oneself**
 Cause because of what he or she approves.
- 23a Contrast (to 22b) But **the one who doubts is condemned**
 b Condition if he or she eats,
 c Basis (for 23a) because that action is not from faith.
- d Basis (for 23a–b) And **everything that is not from faith is sin.**

TEXT: ROMANS 15:1-6

TITLE: SPIRITUAL SUPERGLUE

BIG IDEA:

THE STRONG AND THE WEAK GLORIFY GOD WHEN HELD TOGETHER BY UNSELFISHNESS AND DIVINE ENCOURAGEMENT

INTRODUCTION:

Frank Thielman: Main Idea -- Both the strong and the weak believers in Rome should repay the debt of love they owe one another by agreeing to worship together and work for the common good of the community. To do this is to follow the example of Christ and of the author of **Psalm 69**, both of whom took up the cause of another rather than pleasing themselves. . .

Romans 15:1–6 reminds believers that they should bear the scorn involved in unpopular associations with other believers in order to build those believers up and offer praise to God with a united voice. It is a reminder that recalls Jesus’s own deepest concern for his followers.

Thomas Schreiner: The first two verses summarize the exhortation to the strong. They should strive to edify the weak instead of satisfying their own desires. **Verse 3** provides support for the exhortations in **verses 1–2** by citing **Ps. 69:9**. Christ did not live to please himself but took upon himself the reproaches directed against God. **Verse 4** functions as an aside in the argument. In **verse 3** the OT was cited as support. In **verse 4** Paul now observes that these previous writings were penned for the instruction of believers in the new-covenant era so that they would have hope. Finally, Paul turns to prayer in **verses 5–6**, asking God to work so that believers would live in harmony, in order that God would be glorified by their unity.

Warren Wiersbe: Disunity and disagreement do not glorify God; they rob Him of glory. Abraham’s words to Lot are applicable to today: “*Let there be no strife, I pray thee, between me and thee . . . for we be brethren*” (**Gen. 13:8**). The neighbors were watching! Abraham wanted them to see that he and Lot were different from them because they worshipped the true God. In His prayer in **John 17**, Jesus prayed for the unity of the church to the glory of God (**John 17:20-26**). Receive one another; edify one another; and please one another – **all to the glory of God**.

John Witmer: Paul had written that Christians should not despise or condemn others (**14:1-12**) nor should they hinder the conduct of other Christians (**14:13-23**). Now he gave a third principle to observe when a believer is dealing with fellow Christians: he is to follow the example of the Lord Jesus Christ. Jesus was supremely the Person who ministered on behalf of others, not for Himself. It is fitting, therefore, that those who take His name should imitate him.

David Harrell: So, finally, not only are we to

- respect the weak,
- restrict our liberties and
- resemble Christ, but we are to
- rejoice in unity.

I. (:1) ENCOURAGE THE WEAK RATHER THAN FLAUNTING YOUR LIBERTY

A. By Respecting the Weak

“Now we who are strong ought to bear the weaknesses of those without strength”

Frank Thielman: For the first time, Paul gives a name to the strong and includes himself within this group. The phrase “*the strong*” (οἱ δυνατοί) could refer to society’s “powerful” or “influential” members (1 Cor 1:26; Josephus, J.W. 1.242), and the term may carry something of that connotation here. Its clearest reference, however, is to the strength of conviction with which this group feels free to ignore Jewish dietary customs. The strong person “*believes in such a way that he eats everything*” (14:2), and Paul agrees with this position (14:14, 20). Similarly, “*the weak*” (οἱ ἀδύνατοι) could refer to “the impotent,” “the poor,” and “persons of no importance” (cf. Job 31:20 LXX), but its primary reference here is to the vulnerability of the group’s faith because it is expressed through dietary observances that are actually no longer in force (14:14, 22).

David Harrell: We do not need preference police and rule Nazis running around in the church. Nor do we need freedom fighters flaunting their freedom and condemning those that don’t agree with them and trying to violate their conscience which will ultimately drive people into a deeper form of Legalism. . .

Bear literally means to lift up, to come underneath and help carry a burden. And in this context we are going not see it carries the idea of respecting those who have sincere views that we may not agree with and help carry them. . .

Beloved, the gospel is the gospel of self-denial, not self-fulfillment. You want to reach the unchurched and do what Christ modeled and what he commanded. *Go into all the world and preach the gospel teaching them to observe all the things that the Lord has commanded.* See, the gathering of the saints on Sunday morning is for the purpose of transcendent worship and edification, not accommodating those who hate the God that we love. Evangelism is merely a byproduct of what should happen in a Sunday morning service. To claim that this text is a mandate of pragmatism in ministry is to betray not only a profound ignorance of hermeneutics, which is the science and art of biblical interpretation, but it also betrays a staggering misunderstanding of the nature of the Church and the holiness of God. Paul was not a man pleaser. He said in **Galatians 1:10**:

“For am I now seeking the favor of men, or of God? Or am I striving to please men? If I were still trying to please men, I would not be a bond-servant of Christ.”

Beloved, I would submit to you that had Paul been preaching a seeker sensitive, contextualization he would have never been stoned. He would have never been left for dead. He would have never been scourged, beaten and imprisoned and finally killed for the sake of the gospel. What we must understand in **1 Corinthians nine** and other passages what we see is Paul is making the point that Christian liberty must be circumscribed or restricted by love. That is the

whole theme of 1 Corinthians chapters eight through 10 when he addresses the very issues that he is dealing with again now here in Romans 14 and 15 regarding strong and weak brothers. So Paul saw his liberty in Christ as something to be used for the glory of God, not his own enjoyment. So he was willing to set those things aside if in so doing it would raise the probability that he could share the gospel to the lost and edify those that knew Christ.

David Thompson: The Greek word “*bear*” is one that means to endure, to lift and to take away. This is more than just a toleration of the weakness; it is an attempt to help take the weakness away. The word “*weakness*” is a word used for one who is sick and lacks strength as in some bodily deficiency.

What Paul is saying here is that because of the weak person’s lack of true Biblical and doctrinal understanding of the “faith” system (14:1), he is **deficient**. It is the responsibility of the strong brother or sister to endure the nonsense and work toward lifting that deficiency. Weak people in the faith are sick and they need help, and the strong believer in the church has the responsibility to help.

Now the actual way you help lift the deficiency is by patiently enduring the weakness and by lovingly communicating the truth. This is the responsibility of the strong believer to the weak.

B. By Restricting Our Liberties

“and not just please ourselves.”

S. Lewis Johnson: Strong believers should avoid confirming legalists in their weakness by continually yielding on the things that offend the legalists. It is the responsibility of weak believers to grow to strength, and that can hardly be done if the strong always yield without explanation. Then the life of the body of believers becomes determined by the narrowest and the most prejudiced of its members.

Everett Harrison: As Paul draws the discussion to a close, he openly aligns himself with the strong. They are the ones who hold the key to the solution of the problem. . . . “*Ought*” is not to be watered down as though it means the same thing as “should.” It speaks not of something recommended but of **obligation**. . . . The temptation to be resisted by the strong is the inclination to please themselves, to minister to self-interest. This is the very antithesis of love. For example, were a strong brother to indulge his liberty openly in the presence of a weak brother, this would be labeled self-pleasing, for it would do nothing for the other but grieve or irritate him.

II. (:2-3) EDIFY ONE ANOTHER RATHER THAN LIVING FOR SELF

A. (:2) Unselfish Orientation in Conduct

“Let each of us please his neighbor for his good, to his edification.”

R. Kent Hughes: If you are prone to **judgmentalism** and **exclusiveness**, this is a big pill to swallow. If you are the kind of person who is sure he is right and must have his way, you will not like this at all.

The call here to please others and not ourselves is directed to the “*strong*”—those who have a broader, more Biblical understanding of their freedom in Christ. This, of course, does not mean the “*weak*” are exempt from the responsibility of accepting and being patient with the strong, because **verse 7** subsequently indicates that both strong and weak are to be **accepting**. Nevertheless, the greater burden is on the strong. In God’s household strength denotes obligation. An unwillingness to forgo our rights for others indicates we are not so “*strong*” after all.

B. (:3) Unselfish Example of Christ

1. Summary of the Unselfishness of Christ

“For even Christ did not please Himself;”

John Schultz: As in all the gray areas of moral decisions, we must ask ourselves: “What would Jesus do?” Paul would later write to the Philippians: “*Your attitude should be the same as that of Christ Jesus.*” In every instance, Jesus went farther than any of us could ever go. He, not only, bore the failings of the weak in the sense that He accepted them, He literally took all our weaknesses upon Himself on the cross and carried them away. In support of his statement, Paul quotes from **Psalm Sixty-nine**, which contains several prophecies about Christ’s sufferings. The whole verse that mentions the insults reads: “*For zeal for your house consumes me, and the insults of those who insult you fall on me.*” Another prophecy about the crucifixion is found in **Verse 21** of that Psalm: “*They put gall in my food and gave me vinegar for my thirst.*” We may conclude that if Jesus took our failures upon Himself in such an extreme manner, the least we can do with other people’s weaknesses is to endure them. To the Galatians, Paul wrote: “*Carry each other’s burdens, and in this way you will fulfill the law of Christ.*” The Greek word, rendered “*carry*” is *bastazo*, which means, “*to endure.*”

2. Supporting Scripture

“but as it is written,

‘The reproaches of those who reproached Thee fell upon Me.’”

Frank Thielman: Paul now grounds the preceding exhortation in the **example of Christ** and the **authority of Scripture**. His “*even*” (καί) implies that had anyone been entitled to please himself, it would have been Christ, the “*anointed*” (χριστός) king of God’s people. The Messiah, however, was the sort of king who did not exploit his power for his own advantage but, instead, was willing to suffer in order to help others (cf. **Phil 2:6–8**). This essential **unselfishness** should also characterize believers in their relationships with one another (**Eph 4:32–5:2; Phil 2:4**; cf. **1 Cor 10:33–11:1; 2 Cor 8:9**). . .

Both Christ and the psalmist acted unselfishly in their willingness to identify themselves with the cause of God and absorb the abuse of God’s opponents. This unselfish willingness to suffer in defense of someone else should characterize the relationships between the weak and the strong in Rome, and particularly the relationship of the strong to the weak.

Thomas Schreiner: Jesus’s passion is the supreme example of one who forsakes his own pleasures to advance God’s honor. The citation is from **Ps. 69:9** (68:10 LXX) and matches the

LXX exactly, and the LXX in turn corresponds with the meaning of the MT. The psalm relates how David as a righteous sufferer was forsaken by his friends and attacked by his foes. Paul lifts out the verse, stating that reproaches directed against God have fallen on the righteous sufferer, namely, Christ. Since this psalm is typically used in the NT with reference to Jesus's passion, here it should be restricted to his death. Even though references to the incarnation or earthly life of Jesus are not inappropriate conceptually, they are not the focus here.

John Murray: We may well ask then: how does this feature of our Lord's humiliation bear upon the duty of pleasing our neighbour in the situation which Paul has in view? It is the apparent dissimilarity that points up the force of Jesus' example. There is a profound discrepancy between what Christ did and what the strong are urged to do. He "*pleased not himself*" to the incomparable extent of bearing the enmity of men against God and he bore this reproach because he was jealous for God's honour. He did not by flinching evade any of the stroke. Shall we, the strong, insist on pleasing ourselves in the matter of food and drink to the detriment of God's saints and the edification of Christ's body? It is the complete contrast between Christ's situation and ours that enhances the force of the appeal. The same applies to all the passages in which Christ's example is urged and with the particularity relevant in each case.

(:4) ASIDE – VALUE OF OT HISTORY

A. Authority of OT Scripture

"For whatever was written in earlier times"

Thomas Constable: Paul used his reference to David's experience as an occasion to comment on the usefulness of all Old Testament Scripture ("*whatever was written in earlier times*"). It provides motivation for perseverance and gives encouragement as we seek to remain faithful in our commitment to do God's will. These Scriptures give us hope because in them we see God's approval of those who persevered faithfully in spite of opposition and frustration (cf. Heb. 11).

B. Purpose of Instruction

"was written for our instruction,"

Steven Cole: The historical sections of the Old Testament show us how people succeeded through faith and obedience or failed through unbelief and disobedience. The wisdom books (Job, Proverbs, Ecclesiastes) show us how to think and live rightly. The Psalms teach us to worship God and how to cry out to Him in prayer in all our trials. The prophets warn us of the devastating consequences of sin and the threat of God's judgment if we do not repent. They also encourage us with the truth that God will judge those who persist in evil and He will reward the righteous.

Don't miss the word "*written*" in our text; it occurs twice: "*For whatever was written in earlier times was written for our instruction....*" God saw fit to have His revelation put into written form. This means that to grow in knowing God and His ways, you must become a reader. This implies becoming a thinker and a student so that you can understand the written Word. You must use your mind in dependence upon the Holy Spirit to grow in understanding the truths of the Word. As we saw in **Romans 12:2**, Paul tells us that the way *not* to be conformed to the present

evil age is to be transformed by the renewing of your *mind*. The fact that God communicated His revelation to us in written form appeals to us to use our minds so that we become biblical thinkers. Don't neglect reading and studying the Word. . .

This means that if you're not reading the Old Testament, you're missing a major source for hope in the midst of your trials. Or if you are reading the Old Testament, but it's not changing how you think, how you process your trials, and how you feel in the midst of your trials, you're not reading it rightly. You need the Old Testament because it points you to Christ, who is your sufficiency in all of life. You need it because it instructs you in godly living in the midst of an ungodly world. You need it to give you perseverance, encouragement, and hope in the midst of your trials. I encourage you to make reading the Old Testament a regular part of your time alone with God each day!

C. Process of Perseverance and Encouragement

“that through perseverance and the encouragement of the Scriptures”

D. Goal = Hope

“we might have hope.”

Frank Thielman: Paul intends to describe the Scriptures as the source of both the “*endurance*” and the “*comfort*” of believers. This understanding of the two clauses receives confirmation in the next sentence (**Rom 15:5**) when Paul speaks of God as the source of the “*endurance*” and “*comfort*” that Paul prays will characterize his audience.

The goal of the endurance and encouragement the Scriptures provide is “*hope*” (ἐλπίς). Elsewhere Paul connects endurance in the faith despite suffering with the hope of salvation from God's eschatological wrath (**5:3–5, 9**). Here in **15:4**, however, Paul was probably thinking of the hope that those who believed the gospel had in a future time when all nations, both Jews and non-Jews, would join together in praise of God (**15:13**).

Thomas Schreiner: The authority of the OT is clearly evident in this statement (see **2 Tim. 3:16**). Paul never understood the newness of his gospel to nullify the OT. Indeed, the gospel fulfilled the Scriptures of old (**Rom. 1:2; 3:21, 31; 16:26**). Not only are the Scriptures a source of “*instruction*” (cf. **2 Tim. 3:16**), but also believers derive “*consolation*” (τῆς παρακλήσεως, *tēs paraklēseōs*) from them: the word γραφῶν (*graphōn, Scriptures*) is a genitive of source. Here the word “*consolation*” means that believers receive strength and comfort from the Scriptures to continue living in a way that honors God (cf. **1 Macc. 12:9**). In other words, something is wrong if one only studies the Scriptures academically and does not regularly receive nourishment and strength to live the Christian life. The purpose of the Scriptures (ἵνα, *hina, in order that*) is that believers should have “*hope*.” Once again, the immensely practical role of the OT in the lives of Christians is unfolded. Hope is generated through carefully reading, understanding, and obeying the OT.

<https://biblicalscholarship.wordpress.com/2016/09/07/commentary-on-romans-151-6/>

We must distinguish between Scripture as a source of instruction and encouragement on the one hand and the keeping of particular covenants contained within the OT on the other hand, in this

case the Mosaic covenant with its Law code. Paul believes Christians are not under the Mosaic Law, but this does not mean that he thinks there is nothing to be learned from the OT as a book of prophecy, promises, and instruction. Quite the contrary. He believes the OT is still the inspired word of God and is profitable for teaching and encouragement.

III. (:5-6) EMBRACE GOD'S RESOURCES TO FACILITATE UNIFIED FELLOWSHIP AND WORSHIP

A. (:5) The Gift = Unified Fellowship

“Now may the God who gives perseverance and encouragement grant you to be of the same mind with one another according to Christ Jesus;”

John Murray: These verses are not directly in the form of prayer addressed to God. They are in the form of a wish addressed to men that God would accomplish in them the implied exhortation, an eloquent way of doing two things at the same time, exhortation to men and prayer to God. Without the enabling grace of God exhortation will not bear fruit. Hence the combination.

Thomas Schreiner: Believers should certainly strive for **unity**, but ultimately it is **God's gift**, not a human attainment. **Cranfield** (1979: 737; cf. **D. Moo** 1996: 871) wisely remarks that the unity prayed for here is **not unanimity** on the issues that divide the weak and the strong. Paul is not praying that unity will be achieved via the weak surrendering their unsatisfactory theology. He prays that they will be unified by learning to love and accept one another in the midst of their differences.

John Schultz: We gather from the context of this chapter that “a spirit of unity” does not necessarily consist of uniformity of understanding of truth, but of an acceptance of one another in things that are peripheral.

Thomas Constable: Perseverance and encouragement come to us through the Scriptures, but they are **gifts from God**. Paul wished that all his readers, both the strong and the weak, would appropriate these gifts and apply them in their interpersonal relationships. The result would be **unity** in the church.

Everett Harrison: Endurance and encouragement are ultimately God's gift, though they are mediated through the Scriptures. They tend, however, to be individually appropriated, some realizing them to a greater degree than others. So Paul prays for a spirit of unity (like-mindedness) that will minimize individual differences as all fix their attention on Christ as the pattern for their own lives (cf. v. 3). This does not mean that believers are intended to see eye-to-eye on everything, but that the more Christ fills the spiritual vision, the greater will be the cohesiveness of the church. The centripetal magnetism of the Lord can effectively counter the centrifugal force of individual judgment and opinion. Though this unity will help the church in its witness to the world, Paul is more interested here in its effect on the worship of the people of God – “*with one heart and mouth*” glorifying the God and Father whom Jesus so beautifully glorified on earth.

B. (:6) The Goal = Unified Worship

“that with one accord you may with one voice glorify the God and Father of our Lord Jesus Christ.”

Frank Thielman: The thought of the believing community in Rome glorifying “*the God and Father of our Lord Jesus Christ*” together recalls the letter’s opening greeting: “*Grace to you and peace from God our Father and the Lord Jesus Christ*” (1:7). This echo of the letter’s opening may have alerted Paul’s audience that he was beginning to close his discourse, perhaps emphasizing that one important result of the gospel should be the peaceful coexistence of the believing community expressed in its common worship.

James Dunn: Paul looks not merely for a tacit toleration of differences, but for a mutual acceptance which expresses itself in the common act of worship.

John MacArthur: This expression emphasizes the **deity of Christ**. Jesus is not an adopted son of God; He is of the same essential being and nature as God. This is such an important connection that it appears frequently in the NT (2Co 1:3; 11:31; Eph. 1:3; Col 1:3; 1Pe 1:3).

* * * * *

DEVOTIONAL QUESTIONS:

- 1) Are you looking for ways to serve others and build them up or are you selfishly more interested in pursuing your own wants and desires?
- 2) Does your church give enough attention to teaching the Old Testament?
- 3) As a member of the party of the strong, why doesn’t Paul counsel the believers instead to be more persuasive in convincing the weak that their scruples are unnecessary – given the freedom they now enjoy in Christ?
- 4) Why is unity expressed in corporate worship so important?

* * * * *

QUOTES FOR REFLECTION:

John Schultz: Bible scholars differ in opinion about the last two chapters of this epistle. The fact that there are ancient copies of Romans that omit the chapters 15 and 16 caused some to believe that the original manuscript ended with chapter 14 and the doxology of chapter 16, and that these last two chapters were added later, either by Paul’s own hand or someone else’s. The debate is as old as early church history and there is nothing we can add to it in our day. Since these chapters are included in the canon of Scripture, we do better to study them and consider them to be part of the original.

Michael Gorman: The language of *bearing* and *pleasing* is typical of Paul's exhortations to unity through love:

- bearing others' burdens is how to fulfill the law, or narrative pattern, of Christ, the crucified Messiah (**Gal 6:2**);
- pleasing others (i.e., acting for their benefit and edification) is how one becomes an imitator of Paul and thus of Christ (**1 Cor 10:33–11:1**);
- loving others means not seeking one's own interests in the exercise of spiritual gifts but seeking the edification of the community (**1 Cor 8:1; 13:5; ch. 14, esp. vv. 3–5, 12, 17**);
- becoming a unified, loving community is possible only when, like Christ, believers seek the interests of others rather than their own (**Phil 2:1–4**).

This sort of love reflects and passes on the love of God demonstrated in Christ's death for us, when we were weak (**5:6**). God did not merely put up with us!

Steven Cole: True Christian Unity

**True Christian unity comes from God, is based on Christ Jesus,
and results in glory to God.**

1. True Christian unity comes from God.

- True unity is not primarily organizational unity.
- True unity is not primarily ethnic unity.
- True unity is not primarily cultural unity.
- True unity is not primarily outward conformity.
- True unity comes from God, who gives perseverance and encouragement.

2. True Christian unity is based on Christ Jesus.

A. TRUE CHRISTIAN UNITY IS NOT A MATTER OF AGREEING ON EVERY MINOR POINT OF DOCTRINE OR PRACTICE.

B. TRUE CHRISTIAN UNITY IS BASED ON CHRIST JESUS.

The unity of the Spirit already exists through the new birth. We are exhorted to preserve it in the bond of peace. The unity of the faith is something that we attain to as we mature in our knowledge of Jesus Christ. The unity of the Spirit is true of all believers by virtue of the fact that the Holy Spirit has baptized us into the one body of Christ (**1 Cor. 12:13**). The unity of the faith grows over time as believers grow in their understanding of biblical truth about Christ.

It's also helpful to understand that there are different degrees of importance among biblical doctrines (**Matt. 22:34-40; 23:23-24**). Some doctrines are absolutely essential for salvation. I don't mean that you must understand all these truths to get saved. A person gets saved by believing in Jesus as his Savior and Lord. I mean that to deny these truths knowingly is to deny the Christian faith. All true believers affirm these truths, which include:

The divine inspiration and authority of the Bible; the triune nature of the one God as three persons: the Father, the Son, and the Holy Spirit; God as the creator of all that is; the full deity

and true humanity of Jesus Christ; the sinfulness of the human race; the necessity of the new birth; Christ's substitutionary atonement for our sins; salvation by grace through faith alone, apart from works; the necessity of growth in holiness for all believers; Jesus' bodily resurrection from the dead; His bodily second coming in power and glory to judge the living and the dead; eternal glory with Him in heaven for believers and eternal punishment in hell for unbelievers; and, the personality and work of Satan. **We are not unified with anyone who denies these essential truths.**

Then there are other doctrines that are important for the Christian life, but they are areas where true believers disagree. There are varying degrees of importance with regard to these doctrines: some border on the essential, while others are less important. I would argue that what you believe about the more important issues will impact the way you understand God and His ways and the way you live out your Christian life.

These important doctrines include biblical views on: the specifics of the creation account; God's sovereignty in choosing us for salvation apart from any foreseen faith on our part; the security of salvation for God's elect; how to deal with trials; how to gain victory over sin; the role of psychology in Christian counseling; Christian marriage and family roles; the role of men and women in the church; church government; the place (if any) for the charismatic gifts; the meaning, mode, and subjects of baptism; the meaning of the Lord's Supper; various methods to use in Christian work; and, biblical details about the end times.

Our level of agreement on these issues may determine how close of a personal friendship we may form with another believer. On a church-wide level, we have to think through whether the church should accept into membership the person who differs on one or more of these matters. Will accepting the person into membership lead to dissension or factions in the church? And as a church we need to decide on a case by case basis how closely we can work in areas like evangelism, pro-life causes, or help for the homeless with other churches that differ on some of these matters. I admit that this is not always easy to sort out!

Then there is a third level of doctrine that we could call interesting, but not essential or important. These doctrines won't affect the way you live your Christian life. They include minor details of interpretation of difficult or obscure texts. We should study these matters because they're in the Bible and we may hold personal opinions on them, but we should not divide from other believers over them.

3. True Christian unity results in glory to God.

A. TRUE CHRISTIAN UNITY BEGINS ON THE HEART LEVEL, BUT EXPRESSES ITSELF OUTWARDLY IN GOD-GLORIFYING WORSHIP.

B. GOD IS TRULY GLORIFIED WHEN WE WORSHIP HIM IN TRUTH.

John MacArthur: Since there is one God and there is one Lord and there is one Spirit and the desire of all of them is that we **maintain the unity of the Spirit in the bond of peace**, we ought to be exhorted to do just that. This then is the will of God. This is the will of the Trinity. . .

Paul realizes that one of the great dangers to unity in the church is the **potential discord** between strong and weak Christians. It is of grave concern to him because unity is of such grave concern to him. . .

Now the third principle, in our text, which I just read, is this: **Please one another with Christ as your example.** . .

Now to do this, to please others instead of ourselves, requires several high spiritual motives. And I've listed six of them that take us through the text. Let's move rapidly; six spiritual motives. Let me say this, if you don't have these, you're not going to be able to succeed at this. And if you don't succeed at this, you violate a very grave concern to God and that is the unity of His church. But with these motives, there will be unity among the strong and the weak.

1) Consideration of others.

Seeking to serve others with love rather than attack them with criticism.

2) Disregard for self

Now the bottom line, then, in Christian liberty is "I don't seek to use my liberty. I don't seek to flaunt my liberty. I don't seek to please myself though I may have a right to do that. I may be free to do many things, but I won't do them if they'll cause you to be offended and stumble and be made weak."

3) Conformity to Christ.

Seeking to be like the Lord rather than demanding others be like me.

4) Submission to Scripture.

And this is to say that we are to be seeking to find fulfillment in the Word of God rather than personal aims. We ought to conform to what the Word of God teaches.

5) Dependence on divine power.

6) Seek the glory of God rather than self-glory.

Grant Osborne: Profile of a Strong Church:

- A place of refuge, where people find help **15:1**
- A place of instruction, where people's faith and lives are built **15:2**
- A place centered on Christ, where Jesus is held up as a model **15:3**
- A place filled with the Word, where Scriptures are known and applied **15:4**
- A place of prayer, where endurance and encouragement are known and applied **15:4-5**
- A place of acceptance, where there is an atmosphere and understanding of hope **15:4**
- A place of togetherness, where unity is recognized as a product of God's work **15:5**

Leedy Greek NT Diagrams:

Rom 15:1

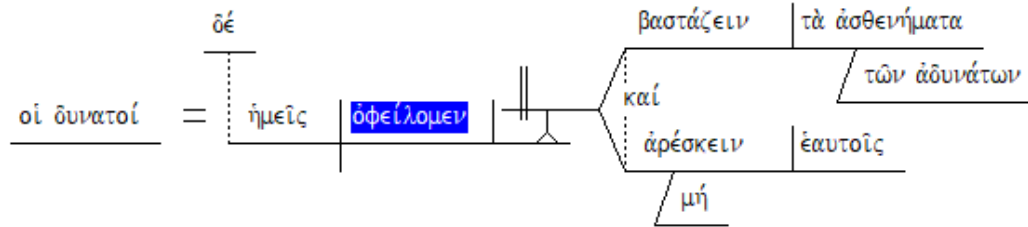

Rom 15:2-3

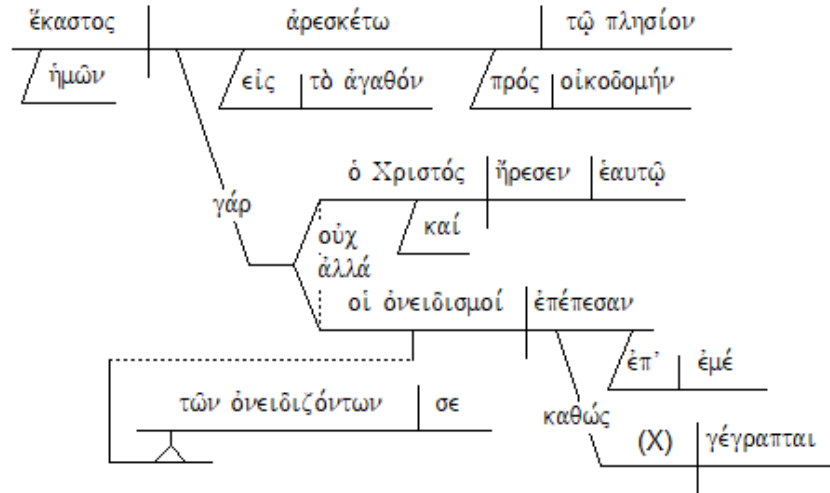

Rom 15:4

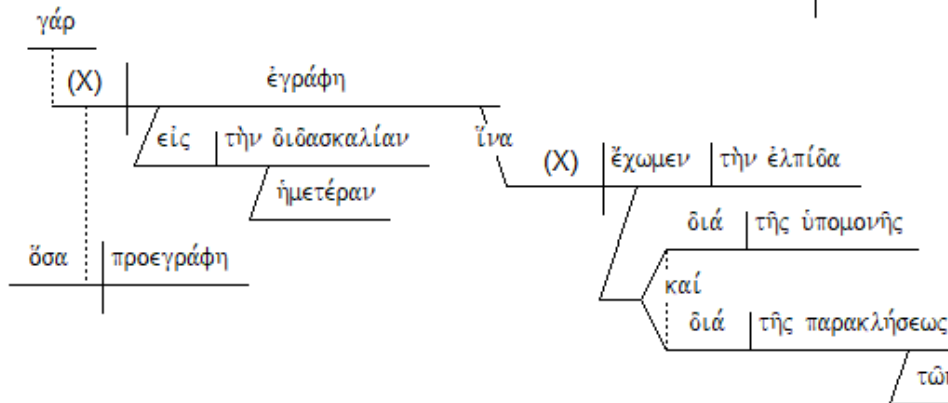

Rom 15:5-6

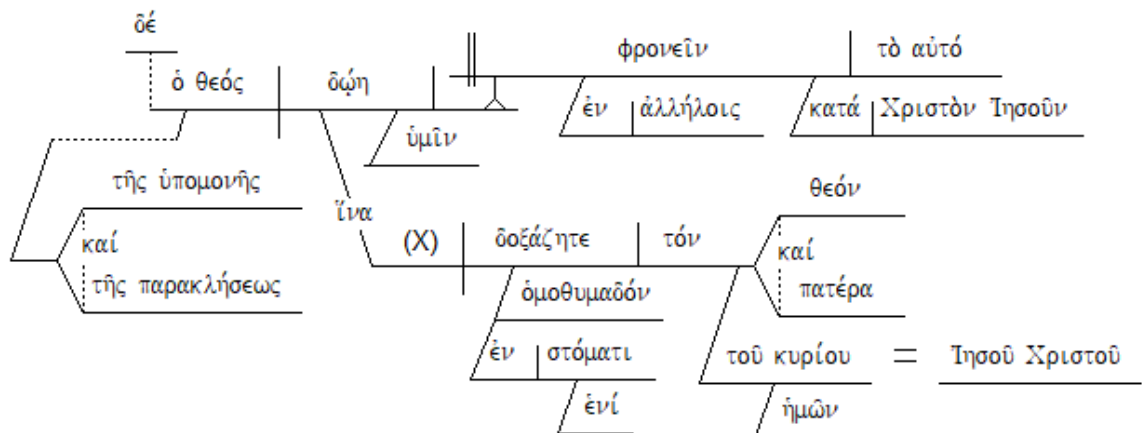

Frank Thielman:

- 1a Exhortation Now **we who are strong have an obligation** to bear the frailties of the weak, and
b Contrast not to please ourselves.
- 2a Exhortation **Each of us must please our neighbor** for the common good,
b Explanation for edification.
- 3a Basis (of 1–2) For **even Christ did not please himself.**
- b Verification Rather, **just as it is written,**
(of 3a) “The reproaches of those who reproach you fell on me.” (Ps 69:9b)
- 4a Inference For **whatever was written**
b beforehand
c **was written**
d Advantage for our instruction,
e Purpose in order that ...
f Means through the endurance and
g the encouragement provided by ↯
h the Scriptures
... we might have hope.
- 5a Desire Now **may the God of endurance and**
b **encouragement grant you**
c Object the same way
d of thinking
e toward one another,
f Measure according to the pattern of Christ Jesus
- 6a Purpose (of 5a) in order that ...
b Manner with one heart and voice
c ... you might glorify the God and
d Father
e Identification of our Lord ↯
Jesus Christ.

TEXT: ROMANS 15:7-13

TITLE: SPIRITUAL SUPERGLUE – ACCEPT ALL BASED ON THE MINISTRY OF CHRIST

BIG IDEA:

THE MINISTRY OF CHRIST BRINGS GLORY TO GOD BY UNITING JEWS AND GENTILES TOGETHER IN PRAISE AND HOPE

INTRODUCTION:

Thomas Schreiner: Throughout the letter the relationship between Jews and gentiles has been a major concern of Paul. Now he calls on both to accept one another for the glory of God. The summons to mutual acceptance should not be restricted to the horizontal level. Toleration of one another is mandated because thereby God’s name is glorified, and the primal sin of **Rom. 1:21**, where God is not glorified and thanked, is reversed by the harmony expressed in worship, in the community. Indeed, **Rom. 15:8–12** reveals that the inclusion of Jews and gentiles together in the church fulfills God’s covenant promises given to Abraham and David. . .

By no means, then, is Paul’s goal merely to establish sociological peace between Jews and gentiles. The goal of his mission is to bring Jews and gentiles together in fervent worship and praise of God. The emphasis on praise provides the clue for the emphasis on hope in **verses 12–13**. Human beings place their hope in what will bring them the greatest happiness in the future. That is, the supreme object of our hope is also the object of our praise and worship. Thus Paul prays that believers will be **filled with hope**, because those who put their hope in God find him to be the delight and joy of their hearts.

John Toews: Paul returns to the opening imperative, welcome, but now broadens it (**v. 7a**). In **14:1** the imperative was to **welcome the weak person**. Here it is to **welcome one another**. Paul broadens his exhortation to include everyone. Christians are to practice mutual acceptance of people with different theologies and values, specifically those who eat different foods and observe different holy days.

Frank Thielman: the opening lines (**15:7–9a**) recall the opening lines of the main section (**14:1–3**) by reusing the term “welcome” (προσλαμβάνεσθε) and recalling the concept of imitating the welcome God has given all kinds of people across the social barriers that otherwise divide them from one another. In **15:3** Paul had extended the idea of imitating the welcome of God from **14:3** to include the imitation of Christ’s unselfishness. When Paul recalls this theme in **15:7–9a**, it is again Christ who provides the example.

Now, however, Paul uses Christ’s example not merely to demonstrate to the weak and strong in Rome how they ought to act toward one another but also to make a point about the significance of Christ for all history. This is the move that ties **14:1 – 15:6** into the argument of the letter from **1:1** forward. Paul argues that Christ’s welcome of both the weak and strong in Rome accomplished on a small scale something that God was doing in Christ on the much larger scale of salvation history. Nonobservant believers in Rome should not hold law-observant believers in contempt or ignore their scruples because at the gospel’s center stands the Jewish Messiah, born

of the seed of David, promised beforehand in the prophets (1:2–3). The gospel is for the Jew first (1:16), and the Jewish people form the cultivated olive tree onto which gentile believers have been grafted and from whose privileges gentile believers derive nourishment (11:17–24). The balance between Jew and gentile in 15:7–13, then, reflects the balance between Jew and gentile in the argument of Romans from the first sentence forward (1:2–5, 16–17; 1:18 – 4:25; 9:1 – 11:36; 14:1 – 15:6).

Main Idea: When the strong and the weak in Rome welcome each other despite their differences over observance of Jewish customs, they not only follow the example of Christ but play a practical role in the fulfillment of God’s promises to Israel in the Scriptures. God had promised Israel he would restore them to full fellowship with himself, and he had described their restoration as part of bringing all the nations of the earth together to worship him. The united worship of Jews and gentiles in Rome, orchestrated by Christ himself, is part of the fulfillment of this universal divine plan.

I. (:7) PLEA FOR MUTUAL ACCEPTANCE (DESPITE DIFFERENCES) BASED ON THE MINISTRY OF CHRIST

“Wherefore, accept one another, just as Christ also accepted us to the glory of God.”

J. Ligon Duncan: This whole discussion that Paul is having with us here assumes that the church is made up widely different constituencies. It is diverse. There are people with different ideas about life, there are people from different backgrounds, and there are people from different socioeconomic groups. There are people from different political persuasions. There are people from all over the map. They are different. They are not the kind of people that would have just naturally drawn together out of all those normal socioeconomic impulses that draw us together with people that are like us. The church is not a collection of people that are like one another naturally and sociologically. That is one thing that is underlining the discussion here. The church is not a homogenous people group. It's not a collection of all sort of people who are all the same. It's a collection of all sorts of people, many of whom are really different.

Thomas Schreiner: Believers should accept one another just as Christ has accepted us, despite our hostility to him, in order to bring glory to God. In the same way that Christ has accepted us, despite our weakness and sin (5:6–10), we too should accept one another. The pronoun “you” (ὁμᾶς, *hymas*) in the clause “Christ has accepted you” demonstrates that both the strong and the weak are designated here. Christ has accepted both the strong and the weak, and thus they should accept one another with all their differences.

Steven Cole: “Accept” means much more than merely to tolerate. It has the notion of **warmly welcoming** others, especially those who are different than you are, into the fellowship of the local church.

Douglas Moo: Just as he exhorted the strong to “accept” the weak (14:1) and rebuked both weak and strong for rejecting each other when God had “accepted” them (14:3), so now he urges them to “accept one another ... just as Christ accepted you.” Through such **mutual acceptance** God will be praised. For God sent Christ to the Jews so that Gentiles also might be able to praise God

(15:8–9a), and the Old Testament likewise predicts that Gentiles will join with Jews in worshipping God (15:9b–12). The balanced emphasis on God’s faithfulness to Jews along with the inclusion of the Gentiles sums up a key motif in Romans. In a sense, then, these verses bring closure not only to the section on the strong and the weak, but to the entire body of the letter. To “accept” one another means not just to tolerate other believers but to welcome them as brothers and sisters in the body of Christ. The “just as” (*kathos*) introducing the next clause in 15:7 may suggest Paul is drawing a comparison: We should accept one another in the same way as Christ has accepted us. But *kathos* probably has a **causal sense** here: We are to welcome one another **because Christ has welcomed each one of us**. What right do we have to refuse fellowship with a person whom Christ himself has accepted into the body? “*In order to bring praise to God*” may be the purpose of Christ’s accepting people. But this phrase more likely depends on the ruling idea of the verse, namely, that we accept one another.

James Dunn: “*Praise/ glory be to God*” (Luke 2:14; 19:38; Rom 11:36; Gal 1:5; Phil 4:20; 1 Clem 20.12; 50.7; cf. Rom 4:20). . . . The phrase can go either with the main clause (Cranfield, Wilckens) or with the *καθώς* clause (e.g., SH, Schmidt).

Steven Cole: I agree with those who say that it applies to **both phrases**. God was glorified when Christ accepted us and He is glorified when we accept one another.

II. (:8-9a) PURPOSE OF THE MINISTRY OF CHRIST TO BOTH JEWS AND GENTILES

Douglas Moo: Structure:

I say that Christ has become a servant of the Jews on behalf of God’s truth,

- (a) in order to confirm the promises made to the patriarchs; and
- (b) in order that the Gentiles might glorify God for his mercy.

Thomas Schreiner: It seems more natural grammatically to understand the infinitive clause in **verse 9** to be parallel to the second infinitive clause in **verse 8**. The flow of thought would be as follows: Christ became a minister of the circumcision “*to confirm the promises to the fathers and so that the gentiles would glorify God for the sake of his mercy.*” In this construction both the infinitives *βεβαιῶσαι* (*bebaiōsai, to confirm*) and *δοξάσαι* (*doxasai, to glorify*) express **purpose**.

A. Ministry of Christ

“*For I say that Christ has become a servant to the circumcision on behalf of the truth of God*”

James Dunn: As in 3:30 *περιτομή* means “*the circumcised*”—the **Jewish people** identified by one of their most distinctive features. It would occasion no surprise that after focusing so much on the Jewish distinctives of food laws and holy days Paul reverts once again to the other striking identity marker of the diaspora Jew, **circumcision** (see on 2:25). The use of the perfect tense (*γεγενῆσθαι*) must mean that Paul intends to describe Jesus as “*servant of the circumcised*” not merely during his earthly ministry (cf. particularly Gal 4:4), but as **still so** (Lietzmann, Barrett, Cranfield, Wilckens), referring not simply to the continuing result of his time on earth

(Käsemann). So presumably his ministry (almost exclusively to the Jews; cf. **Matt 15:24**) and death are in view (as again the echo of **Mark 10:43–45** would imply), but also Jesus in his exaltation (Schlier). The **priority of the Jews** is thus underlined not simply as a temporary factor now no longer operative (as Williams’s alternative rendering, “*servant from the Jews*” [“Righteousness,” 286–88] could imply), **but as a factor which continues to shape the purpose of God**—“*Jew first and also Gentile*” (see on **1:16**; cf. SH; Ljungman, 50–52; Wilckens).

B. Twofold Purpose

1. (:8) Purpose to the Jews – Confirming OT Covenant Promises to the Patriarchs – God’s Faithfulness

“to confirm the promises given to the fathers,”

James Dunn: Paul’s whole point is that Christ became servant of the circumcised not with a view to their salvation alone, but to confirm **both phases** of God’s saving purpose: to Jew first but also to Gentile (cf. Nabadan, 115–18).

2. (:9a) Purpose to the Gentiles – Causing Praise for God’s Mercy for Inclusion – God’s Mercy

“and for the Gentiles to glorify God for His mercy;”

Frank Thielman: When gentile believers in Rome glorify God alongside Jewish believers, this unified group testifies, on one hand, to God’s faithfulness to his promises to Israel and, on the other hand, to his merciful character in sparing from his judgment even gentiles to whom he had made no promises. Their unified worship of God is one of the primary purposes for which Christ welcomed them both into his people (**15:7**) and should be a powerful incentive to them to welcome each other.

Thomas Schreiner: The fulfillment of the promises to the fathers doesn’t exclude the gentiles but includes them; from its inception, the covenant with the fathers pledged that “*all nations*” would receive God’s blessing (**Gen. 12:3; 18:18; 22:18; 26:4**). By definition, then, the fulfillment of the promise to the fathers widens the circle to include the whole world. This is certainly Paul’s understanding of the promise; Abraham is “*heir of the world*” (**Rom. 4:13**) and thus the father of Jews and gentiles (**4:9–17**). Christ’s purpose in coming, then, was not only to certify the promises to the Jews but also to include the gentiles in the circle of his mercy. The word “*mercy*” (ἐλέους, *eleous*) resounds with covenant overtones, reaching back to God’s חֶסֶד (*hesed*, *faithful love*), which, though not identical with God’s covenant, is closely tied to it in the OT (cf. Zobel, TDOT 5:44–64). The gentiles glorify God for his covenant mercy by praising him because they were the undeserved recipients of his saving kindness. We are once again drawn into the themes unfolded in **Rom. 9–11**. Since both Jews and gentiles have been blessed in such a singular way, they should extend acceptance to those in the community who differ from themselves.

Michael Bird: The net point is that God, by bringing Israel’s covenantal history to its appointed climax in the Messiah, has opened the way for the Gentiles to join his renewed people. . .

Assuming this entire scheme — Messiah, patriarchs, Gentiles, mercy, praise, etc. — it would be utterly unthinkable for the believers in Rome to prosecute any prejudice against their Christian brothers and sisters. Gentile Christians should not despise Jewish Christians for they are the ones to whom the Messiah came to serve. Jewish Christians should not judge Gentile Christians for he has brought them into God’s mercy to be praisers of God’s glory. The Messiah accepts each group and God approves of them as his servants. In response, they must show acceptance of each other. Paul thus brings together the many themes of the letter: justification by faith for Jew and Gentile, the redemptive-historical story fulfilled by the Messiah, divine mercy, mutuality, and a united people of God devoted to each other as they engage in a common worship.

III. (:9b-12) PROPHETIC SUPPORT FOR GENTILES BEING INCLUDED IN MUTUAL WORSHIP – 4 OT QUOTATIONS:

Frank Thielman: Paul then demonstrates that the pattern he has just outlined of Christ serving the Jews in order to bring Jews and gentiles together in the worship of God is a *pattern* (καθώς) found in Scripture (**15:9b–12**). He demonstrates this with four quotations, all of which support the notion that Jews and gentiles will worship God together, and the first and last of which support Paul’s claim that Christ, in his role as the Jewish Messiah, will orchestrate this unified praise (**15:9b, 12**). The last and most important of Paul’s quotations (**15:12**) describes gentiles placing their hope in a descendant of David who will rise to rule over them.

Thomas Schreiner: What follows **in verses 9b–12** are scriptural citations from the Torah, Prophets, and Psalms that substantiate the thesis that gentiles and Jews together were to be recipients of covenant blessing. The word καθώς (*kathōs, just as*) introducing the scriptural catena should be understood as a ground, supporting the notion that gentiles as well as Jews were to be the beneficiaries of God’s covenant mercy.

Douglas Moo: God intends for his mercy to Israel to spill over to the Gentiles so that they can join together in praising his name. Paul cites each of the three sections of the Jewish Scriptures: the Torah (**Deut. 32:43 in v. 10**), the Prophets (**Isa. 11:10 in v. 12**), and the Writings (**Ps. 18:49 in v. 9b; Ps. 117:1 in v. 11**). Each quotation refers to the Gentiles, and two of them (**vv. 10, 12**) make clear that their presence in the people of God depends on the Jews. Two of them also speak of praising God (**vv. 9, 11**).

John Schultz: Paul’s quotations are taken from the Septuagint, which explains the slight differences between the Old Testament text and the quotations in this epistle.

A. (:9b) Psalm 18:49; 2 Sam. 22:50

*“as it is written, ‘Therefore I will give praise to Thee among the Gentiles,
And I will sing to Thy name.’”*

Thomas Schreiner: Paul understands gentiles as joining Jewish believers in singing praise to God’s name.

B. (:10) Deut. 32:43

“And again he says, ‘Rejoice, O Gentiles, with His people.’”

James Dunn: in accordance with God’s original purpose and promise the covenant made to Israel is now open to all who believe.

C. (:11) Psalm 117:1

“And again, ‘Praise the Lord all you Gentiles, And let all the peoples praise Him.’”

Frank Thielman: The peoples of the earth are not pictured in two categories, Jews and gentiles, but as a multiethnic assembly in which all are equal before the God whom they worship (cf. **Rom 2:11; 3:29; 4:11–12, 16–17; 11:30–32**).

D. (:12) Isaiah 11:10

“And again Isaiah says, ‘There shall come the root of Jesse, And He who arises to rule over the Gentiles, In Him shall the Gentiles hope.’”

Frank Thielman: **Isaiah 10:5 – 12:6** prophesies God’s judgment on Israel for its godlessness (**10:5–6**), God’s mercy on a remnant (**10:20–23**; cf. **Rom 9:27**), and finally the restoration not only of Israel but of the whole earth under the reign of King David’s descendant. This “*shoot from the stump of Jesse*” (**11:1**; cf. **1 Sam 16:1–13; Acts 13:22**) will provide righteousness and equity for the poor and meek, and the peoples of the earth will live in peace under his reign (**11:1–9**). . .

In **Romans 15:7–13** Paul encourages Christians to step across ethnic boundaries and **worship God together** as a testimony to God’s desire to receive praise from “*all nations*” and “*all the peoples*” (**15:11; Ps 117:1**). As his climactic quotation from **Isaiah 11:10** shows, he understood this unified worship of God as part of God’s plan to bring fairness, justice, faithfulness, and peace to the earth (**Isa 11:1–9**).

Thomas Schreiner: A reference to Jesus’s resurrection is present in the words “*raising up*” (*ἀνιστάμενος, anistamenos*, **Rom. 15:12**; against **Cranfield** 1979: 747; so **Dunn** 1988b: 850; **Hafemann** 2000: 186; **Lohse** 2003: 388). **Hafemann** (2000: 185–87) puts the accent on the future fulfillment in Jesus’s return. Though the future isn’t excluded, Paul emphasizes that the Isaianic promise is being fulfilled now in Jesus’s rule over gentiles, as they put their hope in him (rightly **Schnabel** 2016: 795n271).

James Dunn: Paul takes OT language, which might more naturally hold out hope of (now dispersed [v 9]) Israel’s ultimate dominance over the Gentiles (under the royal Messiah, [v 12]), in fulfillment of God’s covenant faithfulness (v 11), and acknowledged (submissively) by the nations (v 10); and by setting it in different sequence and in the different light cast by the Christ event, he transforms it into an expression of the ideal of a humanity (Gentile with Jew) united in worship of the same God and by hope in the same Christ.

J. Ligon Duncan: Paul's point is simple. Why would they be praising the God of Israel, if the Old Testament were not teaching us to hope for the salvation of the Gentiles through the Messiah of

Israel. In **verse 12**, he quotes from **Isaiah 11:10**, he says look, the one who is the root of Jesse is also the Savior of the Gentiles. In other words, the Savior of the Gentiles was a Jewish descendant from Jesse. So he piles up examples here that Jesus is the Messiah, not only of Israel, but **He's the only hope of the Gentiles**.

IV. (:13) PRAYER FOR JOY AND PEACE STIMULATING ABUNDANT HOPE

A. Joy and Peace in Mutual Faith

“Now may the God of hope fill you with all joy and peace in believing,”

Michael Bird: Paul is cued by the mention of hope in **v. 12** to launch into a prayer about hope in **v. 13**. Hope has been a recurring theme in Paul’s exhortations throughout the letter. The reason is, perhaps, that a constant and common hope of an assured future is what they need to sustain them. Hope is the anticipation of future salvation (**8:24**), a hope of glory (**5:5**), amidst the futility and afflictions of this age (**8:20; 12:12**). The sign that hope in faith has taken root is the effusion of joy and peace that bubbles up in the believer by the Holy Spirit (**14:17; 15:13**).

B. Stimulating Abundant Hope

“that you may abound in hope”

C. Accomplished by the Power of the Holy Spirit

“by the power of the Holy Spirit.”

J. Ligon Duncan: The ability to experience the gospel, to experience unity in the church, depends upon the work of God in us. It's not something that comes to us naturally. The hope that we have to have to go on doesn't come naturally within us. It comes from the filling of the Holy Spirit.

Frank Thielman: Paul’s concluding prayer asks God, who is able to supply the eschatologically oriented hope described in the final quotation, to give that hope in abundance to the Jews and gentiles in Rome who believe the gospel (**15:13**).

Thomas Schreiner: Joy and peace both stem from faith and are by-products of believing in God’s great promises. It also follows that the worship described in **verses 9–12** is joyful and full of peace. Moreover, faith and hope are functioning here as virtual synonyms, for the God who gives hope does so by increasing faith, which results in joy and peace. Paul again emphasizes that hope is not produced by human beings. The source of such hope is *“the power of the Holy Spirit.”*

* * * * *

DEVOTIONAL QUESTIONS:

- 1) How can we help to promote unity in a church context where people come from such diverse backgrounds and hold to differing convictions on peripheral issues?
- 2) Why does the Apostle Paul quote these four specific OT passages?

3) Is our corporate worship characterized by rejoicing and peace as we live out our faith and abound in hope by the power of the Holy Spirit?

4) Is our ultimate church objective more self-fulfillment or the glory of God?

* * * * *

QUOTES FOR REFLECTION:

Douglas Moo: We must read Romans in such a way that we focus on both transformation of the **individual** and formation of the **community**. . .

We must keep things in balance. The heart of the gospel is the message of God's justifying work in Christ. The essential human problem is estrangement from God. Only when this estrangement is overcome and a person is reconciled to God by faith can we speak about God's good news having done its work. Our preaching and teaching must therefore confront people with sin and offer them redemption in Christ.

But God also wants to form people transformed by the gospel into communities that reflect the values of the gospel. Vertical reconciliation with God must lead to horizontal reconciliation with one another. Faithfulness to the gospel demands that any of us involved in ministry should seek to maintain a balance between the two perspectives. Some pastors are marvelous proclaimers of the gospel of individual transformation. They are passionate to save souls, rescuing people lost in sin and destined for hell. I commend their passion. But they need also to make clear—as Paul does in Romans—that the gospel not only rescues people from hell but also transforms whole persons, bringing reconciliation with other people as well as with God.

John Toews: **Romans 15:7-13** has been called the **climax** of the letter, the conclusion of its theological and ethical argument. Just as **1:16-18** opened the main argument of the letter so **15:7-13** concludes it. The gospel as the power of God for the salvation of Jews and Gentiles results in a **unified community of Jews and Gentiles** who with one mind and one voice glorify God. The problem of not honoring God (**1:21**) or dishonoring God (**2:23**) is overcome by a **unified people honoring God**. The christological grounding of this new community in universal praise of God is made clear by the letter's opening confession of the Davidic Messiah (**1:2-4**) and the closing reference to the root of Jesse (**15:12**). Romans is framed by a christological confession about Jesus as the Jewish Messiah who brings salvation and hope to Jews and Gentiles.

David Thompson: Paul gives four main reasons why we are to glorify God and minister to each other:

Reason #1 - Because God had delivered us from our enemies. 15:9b

Paul is quoting from **Psalm 18:48-50**, specifically **verse 49**. David was saying that he will praise God because of the fact that God has made him to rule over all people, both Jews and Gentiles,

and delivered him from his enemies. What Paul is saying is that God has delivered us out of the bondage of sin and that reality should make us praise Him and it should cause us to sing unto His name, and one way we do this is by caring for one another. If you are a believer in Jesus Christ, you should praise God everywhere you go because you have been delivered from sin.

Reason #2 - God will ultimately destroy our enemies. 15:10

Paul quotes Moses (**Deut. 32:43**) in saying, “*Rejoice, O Gentiles, with His people.*” Moses was encouraging the nations who loved God to join in with the praise song that Israel was singing because God was about to destroy His enemies. The implication is that the enemies of God’s people are the opposers and the enemies of God. Our big three enemies are the world, our own flesh, and the Devil. Paul is saying, God is going to destroy those enemies one day and knowing that enables us to demonstrate the grace and mercy of God to others.

Reason #3 - God has given us His eternal love. 15:11

Paul is quoting the shortest chapter in the Bible here, **Psalm 117**. It is a chapter comprised of two verses and the Psalmist is praising God because of His never-ending love . Knowing that we are loved by God frees us to love others. If we ask who is it who loves us to the extent that He would be willing to die for us, plus take away all our sins, there is only one name that will surface, the name of Jesus Christ. Jesus Christ loves us forever and nothing can ever separate us from His love. It is this truth that should cause us to minister to others.

Reason #4 - God will deliver us to His Kingdom. 15:12

Paul is quoting Isaiah in saying that Christ’s reign will be Jewish and it will include Gentiles.

Look at what God has done for us through Jesus Christ. Can’t we minister to each other? Do you want to see what Paul was after? Look at **verse 13**. He wanted a church in which God’s Spirit was powerfully evidenced in a demonstration of joy and peace. In order to have this environment, we need to purpose to treat others as Christ treated us.

John MacArthur: Rejoicing with One Another in the Plan of God

We come then...then to the final section of the final issue before a postscript closes off this great epistle. And in finally discussing the relation of strong and weak believers, he says we ought to rejoice with one another in the plan of God. In other words, it ought to be the concern of all believers not to struggle with each other, not to have division, not to have chaos, not to have hassles with each other, but to accept each other, to embrace each other because this is the plan of God. . .

I want us to see three features:

1. the basic instruction,
2. the biblical illustrations and what I'll call for the sake of alliteration,
3. the benedictory intercession.

The **basic instruction** is in **verse 7**, "*Wherefore, receive ye one another as Christ also received us, to the glory of God.*" Now that's the basic instruction. Wherefore, or therefore, takes us from **verse 6**. Since God's desire is that one with one mind and one mouth we should glorify God, wherefore we have to receive one another. Since God wants us to be one, since that's the eternal design of the church, in order for us to be one mind, that's internally, one mouth, that's externally united we have to receive one another. Now that doesn't mean receiving people into church membership by writing their name on a list. That means receiving them into affection, receiving them into fellowship. It's the same verb used in **chapter 14 verse 1**, where almost the same point is made, "*Him that is weak in faith, receive.*" Receive. Open your arms, embrace. It's calling to communion, to mutual love. The strong receive the weak, the weak receive the strong, the Jew receives the Gentile, the Gentile receives the Jew. And as we shall see, **verse 7** is vital because Jesus is the example of what it means to receive. . .

Now specifically, let's ask a question: how did Christ receive sinners? Or better, how does He? Let me give you four answers to that. First of all, and you might want to jot these down, I think you'll find them helpful. First of all, Christ receives men gladly. That's basic. He receives men gladly. It is not with reluctance, but gladly.

Secondly, Christ not only receives sinners with gladness but he receives sinners in spite of their sin. He receives them in spite of their sin. They don't have to clean up their act first. God doesn't say, "Look, if you can get your life cleaned up I'll take you." No, that's heresy. Not for a minute do we believe that there are some pre-salvation works which man can do for himself to make him receivable, if you will, to make him acceptable to Christ. He receives sinners in spite of their sin. That's the beauty of grace, that's the wonder of Christ's attitude. Go back to Matthew and back to the house, many tax collectors, many sinners sitting down and Jesus is there. The Pharisees say, "*Why is your master eating with tax collectors and sinners? And Jesus says, the ones that are well don't need a physician, but they that are sick.* (That's sarcasm. These men know they're sick.) *Go and learn what that means, I'll have mercy and not sacrifice. I am not come to call the righteous but sinners to repentance.*" He came for those who were sinners. He receives them in spite of their sin, not because they clean their act up. . .

Thirdly, He receives sinners impartially. He receives sinners impartially. The Bible tells us in **Acts 10:35**, in **Romans 2:11** that God is *no respecter* of what? *Of persons*. It does not matter to God whether you're Jew, Gentile, male, female, bond or free, doesn't matter to God what your background is, doesn't matter to God anything, He receives people impartially. And He calls for that same thing in **James chapter 2 verse 1**, "*My brethren, have not the faith of our Lord Jesus Christ, the Lord of glory, with respect of persons.*" Don't let your Christianity have respect of persons. "*If there comes a man into your assembly with a gold ring and fine apparel and a man comes in in a filthy garment, a poor man, and you have respect to the one that wears the fine clothing and say, sit here in a good place, and say to the poor, Out of the way, fellow, get under the footstool, are you not then partial in yourselves and are become judges with evil thoughts? Hearken, my beloved brethren, hath not God chosen the poor of this world to be rich in faith and heirs of the kingdom which He hath promised to them that love Him? But you have despised the poor. Do not rich men oppress you and draw you before the judgment seats, do not they blaspheme that worthy name by the which you are called? If you fulfill the royal law according to the Scripture, thou shalt love thy neighbor as thyself, you do well. But if you have*

respect of persons, you commit sin and are convicted of the sin...convicted of the law as transgressors."

Now we come to our text again, finally, He receives them for the highest reason. And that reason is the **glory of God**. That's the reason He receives sinners, so that it will be to the glory of God. You see, God is glorified when a sinner is saved, is that right? Of course it is. God is glorified when a sinner is saved. **Ephesians 1:4**, "*He has chosen us in Him before the foundation of the world that we should be holy and without blame before Him, in love having predestinated us unto the adoption of sons by Jesus Christ to Himself according to the good pleasure of His will* (Listen to this.) *to the praise of the glory of His grace.*" The reason He saved you was for His own glory, that He might demonstrate His own glory, that He might manifest His own glory, that He might show the principalities and powers, that He might show the angelic host, that He might demonstrate to all beings created His glory. In Ephesians 3:10, His intent is to show the principalities and powers in heavenly places the manifold wisdom of God, and He does that by showing the salvation of the church.

Let's look at the **biblical illustrations**, and these just briefly. He illustrates this point of Jew and Gentile being one in Christ by choosing four Old Testament prophecies that verify Gentile salvation. Did you get that? Four Old Testament prophecies that verify Gentile salvation. They show that the coming Messiah would receive the nations of the world into salvation as partakers of the covenant of grace. And these verses should soften Jewish prejudice in the church at Rome and anywhere else, they should call the Jews to rejoice over Gentile salvation as a fulfillment of Old Testament prophecy rather than allow Gentile salvation to create division and dissension. . .

And Paul closes with a **benedictory intercession**. And I always feel like I'm treading on sacred ground when I try to explain a benediction. All you need to do is read it. "*Now the God of hope fill you with all joy and peace in believing that you may abound in hope through the power of the Holy Spirit.*" That really is the **summation of the whole epistle**. It's a benediction to wrap up everything. And it's a prayer. The God of hope, the God who is the source of eternal hope, the source of eternal life, the source of eternal salvation, fill you up, leaving nothing out. Literally overflow you with joy and peace that comes in believing, that you may super abound in hope through the agency of the power of the Spirit of God. In other words, that's another way of saying, may you get all there is to get and may you know all the joy and all the peace and all the hope that can possibly be given to you through believing in Christ by the power of the Spirit of God.

Thomas Constable: This concludes Paul's exposition of the **theme of the righteousness of God** that constitutes the heart of this epistle (**1:18 - 15:13**).

- Paul showed man's need of God's righteousness (**1:18 - 3:20**),
- how God imputes it to people who trust in His Son (**3:21 - 5:21**),
- and how He imparts it to those to whom He has imputed it (**chs. 6—8**).
- Moreover, he demonstrated that God is consistently righteous in doing all these things (**chs. 9—11**).
- He ended by urging his readers to practice their righteousness in their most important relationships: with God, with the world, and with their fellow believers (**12:1 - 15:13**).

Leedy Greek NT Diagrams:

Rom 15:7

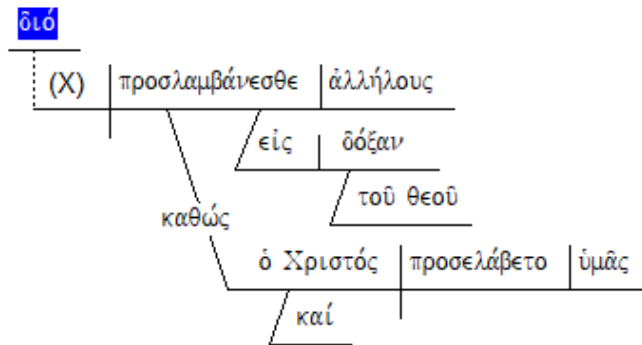

Rom 15:8-9

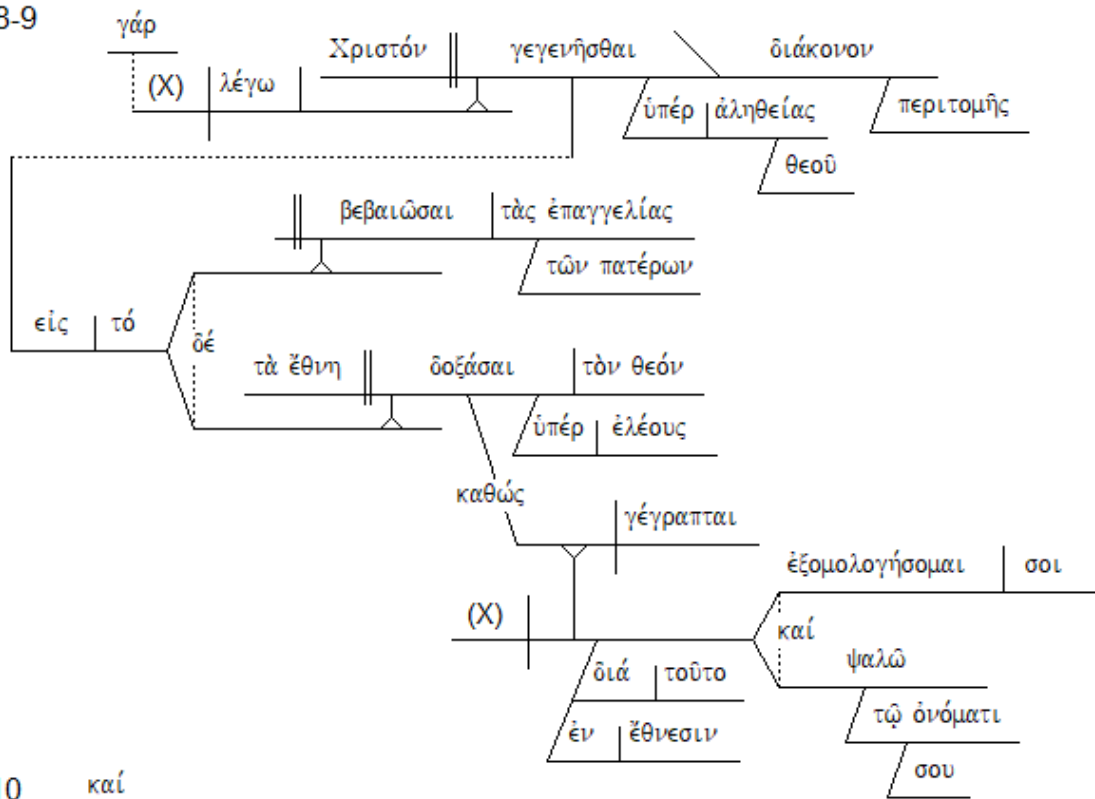

Rom 15:10

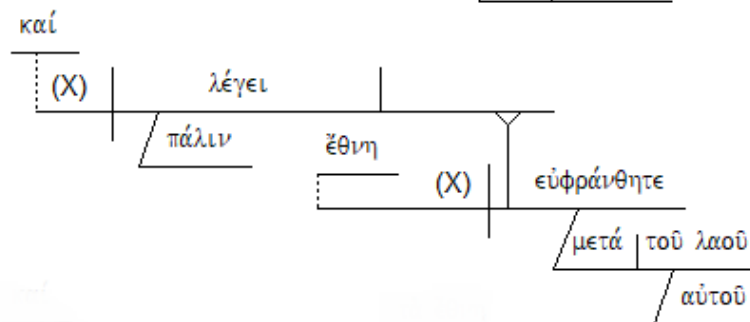

Rom 15:11

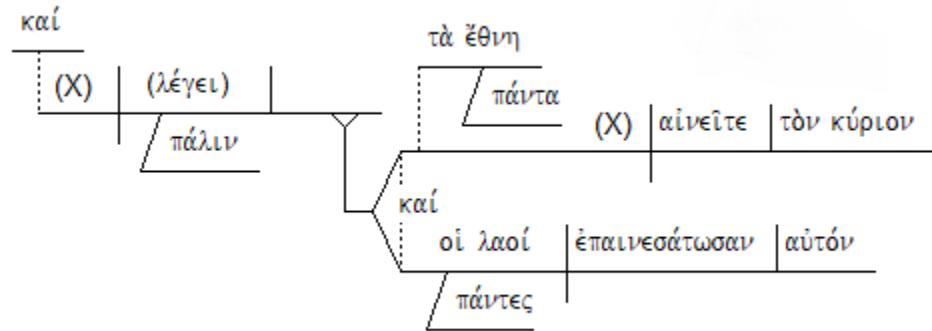

Rom 15:12

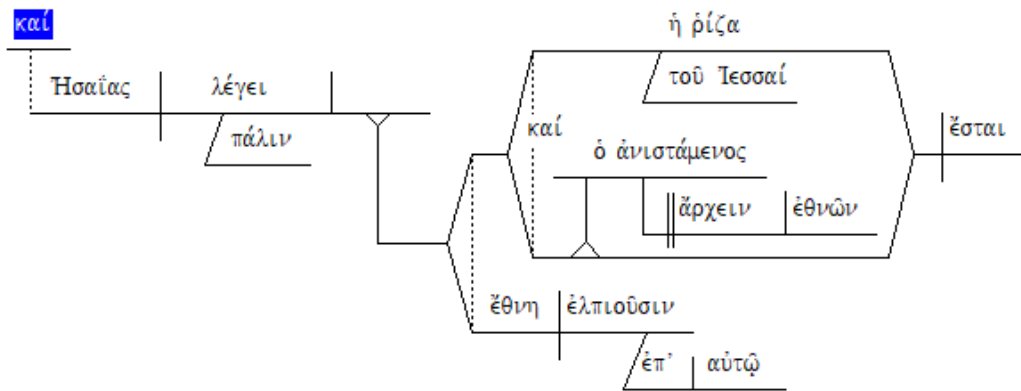

Rom 15:13

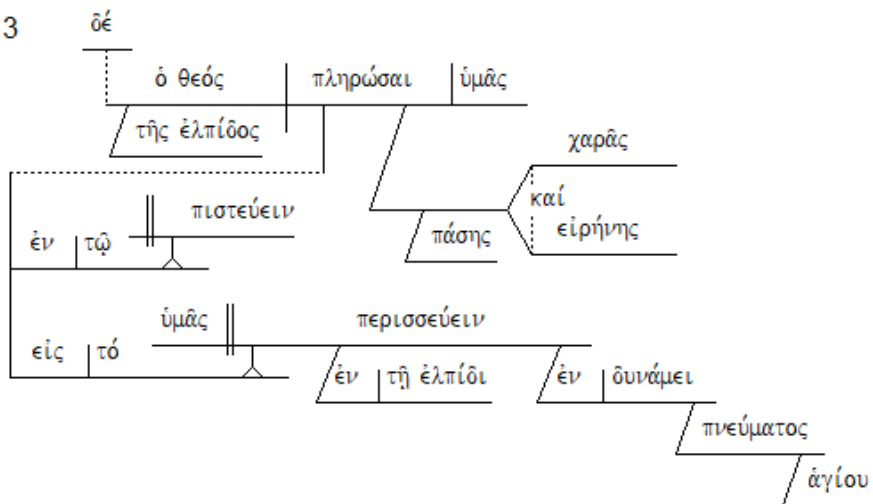

Frank Thielman:

7a Summary	Therefore, welcome one another,
b Comparison	just as Christ welcomed you
c Purpose	for the glory of God.
8a Basis (of 7a)	For I maintain that Christ has become a servant of the circumcision
b Purpose 1 (of 8a)	for the sake of the truthfulness of God
c Restatement (of 8b)	to confirm the promises given to the fathers, and
9a Purpose 2 (of 8a)	that the gentiles might glorify God for the sake of his mercy.
b Verification (of 8-9a) 1	Just as it is written,
	“Because of this
	I confess you among the gentiles,
	and to your name
	I will sing praise.” (2 Sam 22:50/Ps 18:49)
10 Verification (of 8-9a) 2	And again he says,
	“Rejoice, O nations, with his people.” (Deut 32:43)
11 Verification (of 8-9a) 3	And again,
	“Praise the Lord, all nations,
	and let all the peoples extol him.” (Ps 117:1)
12a Verification (of 8-9a) 4	And again, Isaiah says,
b Restatement	“The root of Jesse will come, that is,
c Clarification (of 12b)	the one who rises to rule the gentiles.
	In him the gentiles shall hope.” (Isa 11:10)
13a Desire	Now may the God of hope fill you with all joy and peace
b Sphere (of 13a)	in believing
c Purpose (of 13a)	in order that you might be rich in hope
d Means (of 13c)	by the power of the Holy Spirit.

TEXT: ROMANS 15:14-16

TITLE: BOLD GOSPEL MINISTRY

BIG IDEA:

BOLD GOSPEL MINISTRY MANDATED BY GOD’S GRACE SEEKS THE GROWING MATURITY OF THE SAINTS DESPITE CONFIDENT COMMENDATION

INTRODUCTION:

Frank Thielman: The argument of **15:14–33** unfolds in four steps. The “*now*” (δέ) with which **15:14** begins signals the **start of a new major section**, just as it did in **14:1**, and introduces the first step in the new section (**15:14–16**). Here Paul tells his Roman audience why he felt compelled to write the letter and particularly the “*very bold*” section of **14:1 – 15:13**, in which he has given straightforward advice on their internal affairs. He begins this section apologetically with a strong statement of his confidence in their own goodness, knowledge, and ability to instruct one another (**15:14**), but then defends his decision to write as a reminder to them of what they already know (**15:15**). His authority to do this among gentile believers, he tells them, comes not from himself but from God (**15:16**).

Thomas Schreiner: The flow of thought in these verses can be sketched in briefly. Even though the Romans are full of knowledge and able to instruct one another (**v. 14**), Paul has written boldly to them on a number of points because of his apostolic call (**v. 15**). This call focuses on the gentiles. Paul is a minister who serves as a priest on their behalf so that the offering of the gentiles will be acceptable to God (**v. 16**).

R. Kent Hughes: Paul’s heart is first a heart that sees its mission as entirely **sacred**. Here Paul appropriates the vivid imagery of a Hebrew priest ministering at the altar in the temple. . . . The imagery here is remarkably forceful because the word translated “*minister*” is the same root word from which we derive the word **liturgy**. The word even sounds like it—*lietourgon*. This is most significant, because Paul could have used other words to describe himself. For example, he could have used the common term *doulos* to indicate a servant of Jesus Christ, or he could have used *diakonos*, which means “*servant*” or “*minister*.” But he chose *lietourgon* because he saw his missionary work like that of a **priest** offering sacred worship to God.

John MacArthur: Really, **verses 14 to 21** is in **defense of Paul's boldness**. The whole section is written to defend the way in which he spoke to the Romans. You see, he had never been to that church. He did not found that church. He never pastored that church. He did not personally know that church or fellowship with that church. And yet, throughout this tremendous epistle he had spoken to them with great boldness. Very forthrightly, shoulder to shoulder, nose to nose, he had confronted them on some very crucial issues, not the least of which was the matter of the stronger and the weaker in **chapters 14 and 15**. But he had been very bold in speaking to them and his boldness needs an explanation. How can one whom they have never met, who has not founded that church, nor pastored that church be so bold with them? . . .

So, this is all very **personal** as he gives them his heart. And it's important for him to do that because, having written so boldly, he doesn't want to ruin the relationship with them before it can even get started. He doesn't want to undermine their association because he wants to go to Spain and he sees this church at Rome as a key point to stop off in, collect some supplies so he can go on and evangelize Spain. And he wants a conciliating spirit. He wants them to know not only his doctrine but his heart so that they will not misjudge his confidence and boldness as if it was insensitivity and an unloving spirit.

Everett Harrison: Paul now reflects on the character of his readers and what he can expect his letter to accomplish for them.

I. (:14) CONFIDENT COMMENDATION OF THE CHURCH IN ROME

A. Target of Paul's Instruction = *My Brethren*

"And concerning you, my brethren,"

Matthew Henry: He clears himself from the suspicion of intermeddling needlessly with that which did not belong to him, **Rom. 15:15**. Observe how affectionately he speaks to them: *My brethren* (**Rom. 15:14**), and again, *brethren*, **Rom. 15:15**. He had himself, and taught others, the art of obliging. He calls them all his brethren, to teach them brotherly love one to another

B. Three Areas of Confident Commendation

"I myself also am convinced that you yourselves"

Frank Thielman: The phrase "*I myself*" (καὶ αὐτὸς ἐγώ) is **emphatic** and is followed by an **equally emphatic** and **contrasting** "*you yourselves*" (καὶ αὐτοί).

Mounce: Morally, they were "*full of goodness*," intellectually they were "*complete in knowledge*," and functionally they were "*competent to instruct one another*."

Wuest: I have been completely persuaded with the result that I have arrived at a settled conviction.

1. Moral Makeup

"are full of goodness,"

John Murray: "*Goodness*" (cf. **Gal. 5:22; Eph. 5:9; II Thess. 1:11**) is that virtue opposed to all that is mean and evil and includes uprightness, kindness, and beneficence of heart and life. . . Goodness is the quality which will constrain the strong to refrain from what will injure the weak and knowledge is the attainment that will correct weakness of faith.

2. Intellectual Insight

"filled with all knowledge,"

Matthew Henry: Goodness and knowledge together! A very rare and an excellent conjunction; the head and the heart of the new man.

3. Mutual Ministry [Remember book by Jay Adams = *Competent to Counsel*]
“and able also to admonish one another.”

James Dunn: νοουθετέω (constructed from νοῦν τίθημι = “*put on the mind, instruct*”) denotes basically the well-intentioned attempt to influence mind and disposition by apposite instruction, exhortation, warning, and correction (TDNT 4:1019). . .

Almost as though the whole sweep of the argument from **1:16** to **15:13** had been one long parenthesis, Paul returns to the theme and mood of **1:8–15**. The warm congratulatory tone of **14** echoes the similar note of 1:8. He addresses them as “*my brothers*,” although he had never met the bulk of them; such was the feeling of belonging to a family, with Christ as eldest brother (**8:29**), which Paul had enjoyed in so many congregations round the Great Sea and which transcended the old ties of blood and kinship, that Paul could take it for granted that the Roman Christians would share a similar depth of feeling and mutual regard. The fulsome language is of course exaggerated, in the way that courteous compliments in the East tend to be. Paul would not expect it to be taken literally and phrases the first two items in deliberately vague and nonspecific terms—“*full of goodness, filled with all knowledge*.” But the third and climactic phrase has more point—“*able to admonish one another*.” For this is Paul’s way of stressing his confidence in the **maturity** of the congregations to which he writes: they are able to engage in the delicate business of mutual instruction and correction among themselves; they do not need any help from Paul on that front. Here Paul will have in mind the mutual interdependence of the members of each church (it is no mere coincidence that **15:15** echoes **12:3**): **they have the resources in the Spirit’s engraving through one another to cope with all their problems.**

John MacArthur: “*You are competent to counsel.*” They can act without Paul, is what he is saying. You can act without me. With all you know, having all knowledge revealed by God, with all you are, having true goodness of life, you are able to counsel one another. You are able to admonish one another. And the word here is *nouthete*. It means to lead someone away from a false path into a true path by warning and teaching. It’s a comprehensive word for counseling. And, of course, in our particular culture today we hear so much about who is competent to counsel. And there are those people who would tell us that the only ones competent to counsel are worldly trained psychiatrists and psychologists. I heard that day after day after day after day during the trial of the lawsuit in which I was engaged, that people in the ministry are utterly incompetent to counsel, that there’s no way we can handle quote-unquote “psychological problems,” that there are problems far beyond the purview of anyone treating it with the Word of God. You have to know Freud, you have to know Carl Rogers, you have to know Jung, you’ve got to know all this and have all kinds of worldly information in order to deal with people’s problems. But what the Scripture says here is if you have all knowledge of the revelation of God and your life is characterized by being full of moral purity, you are competent to counsel, in spite of what the world may say. And it’s tragic that even in some church circles and some theological circles and within some Christian institutions, the line has been sent out that no one without worldly, humanistic, psychological training is competent to counsel, and that’s not true. We are competent to admonish one another within the family of God based upon the quality of our life and the knowledge of the revelation of God.

II. (:15-16) MINISTRY MANDATE BY GOD'S GRACE JUSTIFIES A BOLD APPROACH

A. (:15a) Purpose of Paul's Bold Approach = Growing Maturity of the Saints

1. Reality of His Bold Approach

"But I have written very boldly to you on some points,"

Ray Stedman: Now, you would think that a church that was theologically knowledgeable, able to instruct and counsel one another in the deep problems of life, and filled with a spirit of goodness and compassion, would hardly need anything more said to them. Yet it is to that kind of a church that Paul addressed his letter to the Romans.

Grant Osborne: It may have seemed **bold** of him to write in this manner to a church he had not founded, but he was the apostle to the Gentiles, and it was in that capacity that he wrote to them.

2. Reminders Were Necessary to Continue on the Path to Maturity

"so as to remind you again,"

Frank Thielman: Paul issued a straightforward set of ethical admonitions to the Romans in **12:1 – 15:13** and emphasized what they already knew, because urging gentile believers to persevere in their commitment to the gospel was an important part of the assignment God had given him.

Thomas Schreiner: The reason Paul wrote "*rather boldly*" (τολμηρότερον, *tolmēroteron*) "*on some points*" (ἀπὸ μέρους, *apo merous*) was not due to the **inadequacy** of the Roman community. . . . He wrote for the purpose of **reminding them** of truths they already knew. Such reminders were part of the common stock of early Christian *paraenesis* (cf. **1 Cor. 4:17; 2 Tim. 1:6; 2:8, 14; Titus 3:1; Heb. 13:3, 7; 2 Pet. 1:12; 3:2; Jude 5, 17**). What Paul emphasizes is that his reminders are **rooted in apostolic authority**, the grace that commissioned him into the apostolic office (cf. **Rom. 1:5; 12:3; 1 Cor. 3:10; Gal. 2:9; Eph. 3:2, 7–8; Col. 1:25**).

John MacArthur: You remember how Paul tells Timothy to keep teaching sound doctrine over and over and reminding the people and nourishing them in it. And you remember how Peter writes in 2 Peter 1 and says, "*I keep telling you these things so that after I'm gone you'll hear their echo the rest of your life.*" I want you to remember. I want you to remember. You see, any good teacher knows two things. Two things you have to recognize in teaching. One is **familiarity** and the other is **forgetfulness**. Those are two things we have to take in to account. I realize the principle of **forgetfulness**. That is to say what I have said in the past you have already forgotten. I don't like that principle but it's true. If I were to quiz you on this morning's service, I don't want to do that because I don't want to see your answers, but I realize that what I have said you have forgotten. You know how I know that? Because what I've said I've forgotten. And people sometimes say, "Do you ever listen to your tapes?" And I have a standard answer, "Only to find out what I believe on things." And that's the truth because I can't remember how I interpreted a passage either, if you go back far enough. So we do tend to forget. And any good teacher knows that you must repeat things. That's why throughout the

teaching of our Lord there is the repetition of many great truths, and the same with Paul. His epistles intersect over and over again with the same truth. You have to understand forgetfulness.

The second thing you have to understand is **familiarity**. While reminding them you cannot say things in the way you've always said them or they don't hear them because the terminology is so familiar they think they understand what you're saying and it's water off the duck's back. So the challenge of teaching is to repeat to your people the same stuff over and over again in ways they think they've never heard. Now you know. That's the big secret. But that's the challenge. People say, "Do you use notes when you preach?" Of course I use notes. If I didn't I'd revert back to saying the same thing in the same way every week and you'd all be gone. And so in order to stay fresh, that's the challenge of the ministry, that's what puts me in the study 30 hours a week, to stay fresh so that what I say to you, though we may understand the general truth, comes to you in terms you've not heard before in passages you've not studied before.

B. (:15b) Privilege of Paul's Calling = a Gracious Gift from God

"because of the grace that was given me from God,"

Frank Thielman: "grace" (χάρις) here refers to the **vocation** God had given to Paul of calling the gentiles to believe the gospel (**1:5, 16–17**).

John MacArthur: So the thing that energized his ministry was God's outpoured grace. And by that he means the power and flow of the energy of God that compelled him to serve, which he saw as grace because it was undeserved, because he was unworthy of it. . .

So, in **defense of boldness** Paul says if you're going to be upset, don't be upset with me, call heaven, I'm under orders. I mean, after all, he really didn't write Romans on his own, did he? Was it not that he was compelled by the Spirit of God? In **Romans 1:1** he identifies himself in the opening of the letter, "*Paul, a servant of Jesus Christ, called to be an apostle and separated unto the gospel of God.*" And in **verse 5**: "*By whom we have received grace and apostleship.*" You see, God graciously made him an apostle, **he's under mandate**. He has a duty. And this is a compelling thing with him, as it must be with anyone who speaks on behalf of the Lord.

C. (:16a) Purpose of Paul's Ministry as Apostle to the Gentiles

1. Focused on Bringing Christ Jesus to the Gentiles

"to be a minister of Christ Jesus to the Gentiles,"

Grant Osborne: The Greek word here is *leitourgon*, meaning "public servant."

2. Functioning as a Priest in Proclaiming the Gospel of God

"ministering as a priest the gospel of God,"

James Dunn: The immediate explanation of what Paul's commissioning means for him ("*minister of Christ Jesus for the Gentiles*") would inevitably strike Paul's audience very powerfully by virtue of its intense concentration of cultic terminology—"officiating priest," "serving as a priest," "sacrificial offering of the Gentiles," "set apart as a sacrifice"). Such a

concentration of imagery can be neither unintentional nor casual. This is Paul's way of underscoring his theological exposition of the gospel (1:16 - 15:13) in its outworking in his own missionary vocation. For one thing it brings home the **continuity between his ministry and the whole revelation of Israel**, centered to such a degree as it was on the law and the law of the cult: Paul claims to be wholly in continuity and succession with the main line of salvation-revelation in the OT, not excluding the law. But more striking still is the way he transforms and **transcends** all that had hitherto been bound up in that cultic language. By applying it to his own noncultic ministry of preaching the gospel he confirms that for him the **cultic barrier between sacred and secular has been broken through and left behind**. And by speaking of the Gentiles as themselves the sacrifice, Gentiles who could not even approach the altar of sacrifice in the Temple, who were instinctively regarded by the typically devout Jew as outside the covenant, unclean, Paul confirms that for him **the cultically defined barrier between peoples, between Jew and Gentile, had been broken through and left behind**. In view of the tensions within their own congregations on matters of ritual purity (14:1 - 15:6), the Roman readership would not need reminding that cult and ritual served then (as ever) to express group identity and to mark out group boundaries. Nor would they need reminding that their weekly meetings without priest and without sacrifice or libation were highly unusual phenomena for their time. Paul's purpose seems to be to underline the **eschatologically new fact** that within God's **redefined people** ("set apart by the Holy Spirit") all ministry on behalf of others is priestly ministry (as in **Phil 2:25**), and that cultic sacrifice has been replaced by the sacrifice of committed day-to-day living in personal relationships (12:1).

D. (:16b) Presentation of the Gentiles as an Acceptable, Sanctified Offering

1. Acceptable Offering

"that my offering of the Gentiles might become acceptable,"

Frank Thielman: Within the context Paul's focus is on his role as one who offers sacrifice to God, and a secondary reference to the gentiles also offering something to God would complicate the imagery. Paul, then, speaks metaphorically of himself as a priest offering the gentile believers to God.

John Murray: The expression "*the offering up of the Gentiles*" is without precise parallel in the New Testament. But it has its parallel in **Isaiah 66:20**: "*And they shall bring all your brethren out of all the nations for an offering unto the Lord*". It may be that Paul derived this concept from the Isainic passage which appears in a context of blessing to all nations and tongues (cf. **Isa. 66:18**).

2. Sanctified Offering

"sanctified by the Holy Spirit."

Thomas Schreiner: What Paul emphasizes here is his **divine commission** to bring the gospel to the gentiles. Grace was bestowed on him (**Rom. 15:15**) so that he would serve as **God's priestly minister** in serving up the gentiles as an **offering**. Since Paul had this calling as a priest, his offering of the gentiles is "*acceptable*" (εὐπρόσδεκτος, *euprosdektos*) to God. Another cultic term, "*sanctified*" (ἡγιασμένη, *hēgiasmenē*), describes the suitability of the offering that consists of the gentiles. Such an offering is specially set apart for God, pleasing to him because it has

been set apart “by the Holy Spirit” (ἐν πνεύματι ἁγίῳ, *en pneumati hagiō*).

Matthew Henry: Paul preached to them, and dealt with them; but that which made them sacrifices to God was their sanctification; and this was not his work, but the work of the Holy Ghost. None are acceptably offered to God but those that are sanctified: unholy things can never be pleasing to the holy God.

Douglas Moo: The epexegetic genitive suits the context better. In other words, Paul pictures himself as a priest, using the gospel as the means by which he offers his Gentile converts as a sacrifice acceptable to God. But, like the animal sacrifices of the old economy, these new sacrifices also must be “*sanctified by the Holy Spirit*” if they are to be acceptable.

* * * * *

DEVOTIONAL QUESTIONS:

- 1) How much of Paul’s commendation to the church at Rome here is sincere vs. flattery or just hyperbole?
- 2) Have we been impacted by our secular culture to turn to professional (usually humanistic trained) counselors to address behavior issues or do we have confidence that mature believers are **competent to counsel** – relying on the resources of God’s Word and God’s Spirit?
- 3) Why can we never be complacent with our level of Christian maturity?
- 4) Do you view the results of your ministry (mandated by God’s grace and accomplished by the power of His Spirit) as an offering acceptable and sanctified to God?

* * * * *

QUOTES FOR REFLECTION:

Frank Thielman: Main Idea (:14-33)

Paul’s letter to the Christians in Rome had two primary purposes.

- First, it was Paul’s effort to exercise his God-given responsibility to proclaim the gospel to the gentiles in Rome and encourage their obedience to its implications. For the Romans, this meant preaching the gospel to them in a way that showed how important their unity with one another was despite their different convictions on the way in which Christianity was related to Judaism.
- Second, it was Paul’s request to the Romans for their help in fulfilling his apostolic vocation. He hoped they would support both his ministry to the needy Jewish Christians in Jerusalem and his future work in Spain.

John Schultz: This paragraph could lead to the conclusion that the church of Rome consisted exclusively of Gentile believers. But that conclusion might be too hasty to hold up to scrutiny.

Paul, undoubtedly, addresses the Gentile part of the church in these verses, but that does not mean that no Jews were present. His explanation how the Lord appointed him to be a minister to the Gentiles would help the Jews to overcome their innate Jewish prejudice against anybody not Jewish in the church.

Thomas Schreiner: Is what Paul writes here **flattery**? Certainly, there is **hyperbole** in the terms “full” (μεστοί, *mestoi*) and “filled” (πεπληρωμένοι, *peplērōmenoi*). Paul hardly means that the Romans are perfectly good and know everything exhaustively! Yet it would be a mistake to designate his words as flattery. He is probably thinking of the community as a whole (**Schlatter** 1995: 264). **Cranfield** (1979: 752) is correct in saying that we must distinguish between flattery and **courtesy**. The latter assumes the spiritual maturity of other believers unless there are good reasons to think otherwise. Such courtesy is not merely wishful thinking, for the gospel “*is the power of God unto salvation*” (**Rom. 1:16**): it transforms human beings, and that includes their way of thinking. Paul has already remarked that their faith is being proclaimed throughout the world (**1:8**). **Schlatter** (1995: 264) is also right in saying that Paul does not want to bind the believers to himself. He wants them to live independently by faith.

Steven Cole: Six Principles for Your Ministry

- Ministry Principle 1: If you’re a Christian, you’re in the ministry.
- Ministry Principle 2: To minister effectively to others, you must know and personally apply biblical truth in your walk with the Lord.
- Ministry Principle 3: Trust God to work through others in the body and affirm their ministries.
- Ministry Principle 4: Be sensitive towards others.
- Ministry Principle 5: Don’t hesitate to be bold in challenging others or in reminding them of what they already know.
- Ministry Principle 6: Offer your ministry to God as an act of worship, pleasing to Him.

Ray Stedman: In faithful fulfillment of his unique apostolic calling, Paul’s supreme offering to God then was the Gentiles, who by virtue of the Holy Spirit’s power had been justified, sanctified and redeemed, made holy by the blood of Christ and thus made acceptable for fellowship with the Father. Like Paul, every believer who is instrumental in winning a soul to Jesus Christ presents that convert, whether Jew or Gentile, as a priestly offering to the Lord. God is not after buildings, programs, money, equipment, etc. He is after the lives of people. This truth helps understand Paul’s description of the saints at Philippi that he was instrumental in winning to Christ:

"Therefore, my beloved brethren whom I long to see, my joy and crown, so stand firm in the Lord, my beloved." (Php 4:1)

In a similar exclamation in first Thessalonians we read Paul’s description of the Thessalonian believers he to whom he had been privileged to proclaim the gospel of Jesus Christ...

"For who is our hope or joy or crown of exultation? Is it not even you, in the presence of our Lord Jesus at His coming? For you are our glory and joy." (1Th 2:19-20)

These Gentiles were his "acceptable offering" to the Lord as he faithfully carried out the priestly function of "ministering" the gospel of God. Let this awesome truth provoke us to be faithful witnesses like Paul.

Leedy Greek NT Diagrams:

Rom 15:14

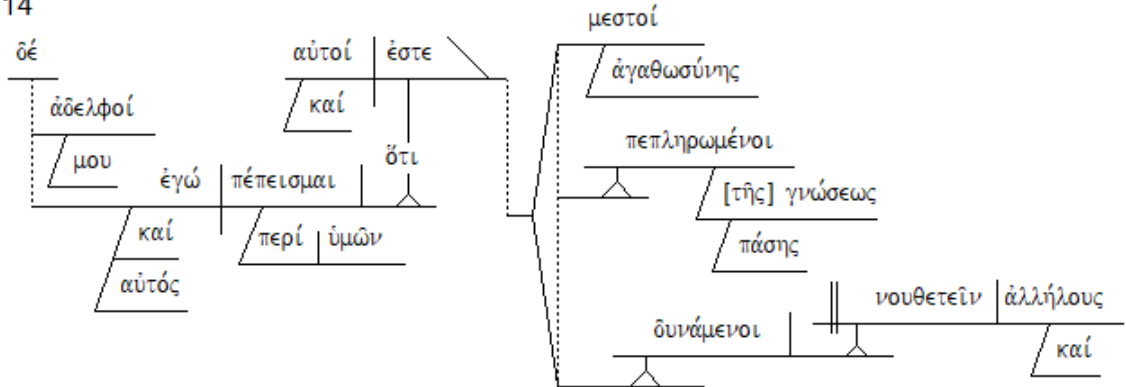

Rom 15:15-16

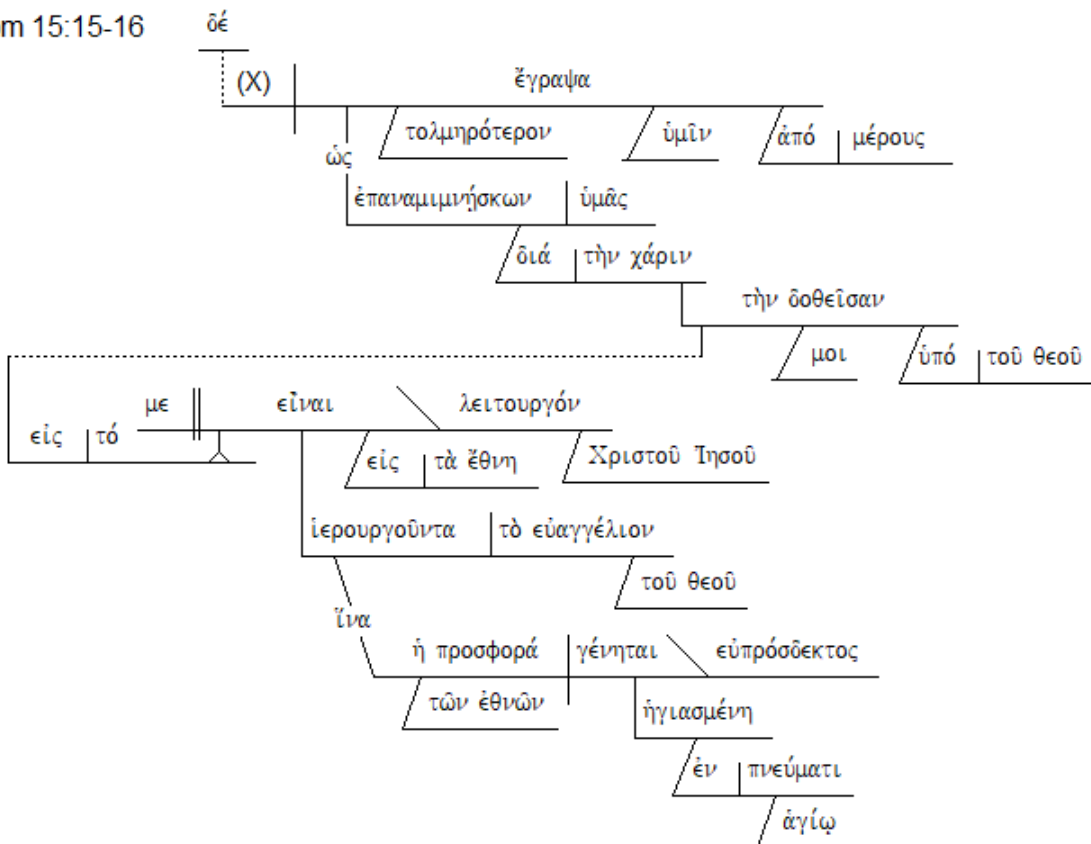

TEXT: ROMANS 15:17-21

TITLE: GIVE CREDIT WHERE CREDIT IS DUE

BIG IDEA:

REFLECTING ON PAST MINISTRY SHOULD CAUSE US TO GIVE ALL CREDIT TO GOD

INTRODUCTION:

Frank Thielman: The next section (**15:17–21**) continues to describe the shape that God’s apostolic call has given to Paul’s ministry, but shifts from the present letter to **Paul’s past work**. “Therefore” (οὖν) in the first sentence signals a transition to the new section, and this first sentence is itself **transitional**, pointing back to Paul’s general description of his call in **15:16** and forward to the examples he will give in **15:18–21** of what Christ has accomplished through him among the gentiles in the past. The last part of this section ends with a general principle that Paul observes in all his work and explains why his past work had stretched over such a large area. He was “eager to preach the gospel where Christ has not been named” so that he “might not build on another’s foundation” (**15:20–21**). This provides an effective transition to a discussion of his future work in the next section, which will include the surprising news that he will not stay in Rome for long but will quickly press on to Spain, where Christ has not been named.

R. Kent Hughes: Paul mentions here at least three marvelous happenings in his life:

- 1) Gentiles came to belief,
- 2) signs and wonders accompanied his ministry, and
- 3) he himself preached the entire 1,400 miles from Jerusalem to Illyricum, which is in present-day Yugoslavia. Not bad—especially in sandals!

But Paul takes no credit. Christ did it through him.

John Toews: Paul knows that boasting is dangerous. He immediately qualifies his boasting, therefore, by asserting that he does not dare to speak about anything except what Christ has accomplished through me (**v. 18**). Paul is only an agent for doing the work of Christ. The goal of that work is the obedience of the Gentiles in word and work. In **1:5** the goal was the faithful obedience of the Gentiles, here it is the holistic obedience (speech and behavior) of the Gentiles. Paul has worked toward that goal in power ... by means of the power of the Holy Spirit (**v. 19a**). The gospel is the power of God (**1:16**) and Paul has served that gospel in power. The evidence of that power is signs and wonders, Jewish language for describing the miracles of Israel’s exodus from Egypt. The significance of Paul’s mission is parallel to the Exodus event—just as Moses led Israel from slavery in Egypt into the freedom of the promised land so Paul has led the Gentiles from slavery in Sin and exclusion from God’s people into the eschatological people of God.

John Witmer: Paul recognized that all credit goes to Christ. And yet Paul was involved; God worked by what he had said and done. The apostle had been used by God to perform *signs* (*simeion*, miracles that signify theological truths) and *miracles* (*teraton*, miracles that produce

wonder). . . And all this, Paul said, was through the power of the Spirit (cf. **Rom. 15:13**). Anything Paul achieved that was worthy of praise had God's grace as its source, Jesus Christ as its motivation and goal, and the Holy Spirit as its energy. . . Paul purposed to be a true pioneer evangelist, opening virgin territory to the good news of God's grace in Jesus Christ.

J. Ligon Duncan: In this brief passage (:14-21), Paul tells us something of his **plan and pattern of ministry**. He tells us of his desire to go to places where the gospel had not been heard. He tells us about his desire to see people converted to Christ who have never heard His name named. He tells us about his desire, not simply to be the one who sees a person make a profession of faith in Christ, but the one who sees a person built up by the Holy Spirit, changed, transformed, growing, a real disciple. He tells the Romans why he wrote to them and why he wrote so boldly and he gives a beautiful estimation what he sees in them in terms of the spirits work in sanctification. I would like to look at some of those things with you tonight. Paul is not just describing for us something that has no relevance to other Christians but himself. He's not just telling you how he went about his business because he wanted to talk about himself. Paul is sharing with us his designs in ministry and his desires in ministry and his goals in ministry and his pattern in ministry because he wants these things to capture our hearts too. He wants us to think in these terms in the way we relate to one another. He wants us to think in these terms as we view ourselves as disciples in the world who are witnesses to the Lord Jesus Christ.

I. (:17) REFLECTING ON PAST MINISTRY ALLOWS US TO BOAST IN WHAT GOD HAS ACCOMPLISHED THROUGH US

“Therefore in Christ Jesus I have found reason for boasting in things pertaining to God.”

Frank Thielman: The article (τήν) points back to **15:15–16** and shows that the “*boast*” Paul refers to is his call to evangelize and instruct the gentiles and to present them, as a priest might, to God. He points out that he only has this boast because he is “*in Christ Jesus*” and that the boast itself consists only of “*the things that pertain to God.*” It is, therefore, qualitatively different than either ethnic boasting (**3:27; 11:18**) or boasting in one's own works (**4:2**), both of which the gospel excludes. Nevertheless, the boast is only possible because Paul possessed a certain role and competence that qualified him to speak boldly, even to gentile believers in a city that he had never visited.

Thomas Schreiner: The “*therefore*” signals that his boast is in what God has done on his behalf, for it is God who commissioned him as the apostle to the gentiles and it is God who ordained that his offering of the gentiles would be pleasing in his sight.

Bruce Hurt: “Seeing I have received this office from God and am appointed a minister of the Gospel to the Gentiles, I have confidence and rejoice.” Since in the previous verses Paul has asserted his divine appointment as an apostle, he shows, in this and the following verses, that the assertion was well founded, as God had crowned his labors with success and sealed his ministry with signs and wonders. Therefore, he was entitled as a minister of God to exhort and admonish his brothers with the boldness and authority which he had used in this letter.

Douglas Moo: Because God is the One who has given Paul this service, he can legitimately “glory” in it (v. 17). Glorifying or boasting in something can be wrong when we are trying to take credit for our own achievement (cf. 2:17, 23; 3:27; 4:2–3), but it is appropriate when it is the product of God’s own work (cf. 5:2, 3, 11).

John Schultz: Boasting, like humility, is always a **fragile matter**; it evaporates when you touch it. The only reason Paul mentions it here is because he intends to visit the church in Rome and he wants them to be prepared to receive a blessing. That is why he writes in vs. 19: “*I know that when I come to you, I will come in the full measure of the blessing of Christ.*” In his first epistle to the Corinthians, the apostle stated the same principle: “*For I resolved to know nothing while I was with you except Jesus Christ and him crucified. I came to you in weakness and fear, and with much trembling. My message and my preaching were not with wise and persuasive words, but with a demonstration of the Spirit’s power, so that your faith might not rest on men’s wisdom, but on God’s power.*” If we have identified ourselves with Jesus Christ in His death and resurrection and if we have turned over to Him to control of our life, we may, in humble appreciation, boast in what God does in and through us in blessing other people. Denying that God uses us is not a sign of humility; it can be a form of well-disguised pride.

II. (:18-19) REFLECTING ON PAST MINISTRY GIVES GOD ALL THE CREDIT FOR THE POSITIVE RESULTS

A. (:18a) Positive Results through the Agency of Christ

“For I will not presume to speak of anything except what Christ has accomplished through me,”

Frank Thielman: Paul’s boast is in no way a claim to special status or power for himself, but only an explanation of why he claims **apostolic authority among the gentiles**.

James Dunn: Note the balance of Χριστὸς δι’ ἐμοῦ: anything achieved has been done by Christ; but the agency is Paul’s. This is the emphasis which Paul wants to retain in any assessment of his work.

Everett Harrison: He restricts his glorying to Christ Jesus (cf. Gal 6:13, 14), the one he serves as a minister (cf. v. 16). This relationship means not only that the glory goes to the Savior, but also that as the minister of Christ Paul must depend on him for everything that is accomplished in connection with his mission. Paul is only the instrument by which God brings Gentiles to obey him in faith and life (cf. 1:5). Christ is the one ultimately responsible as he continues to work through his servant (cf. Acts 1:1).

B. (:18b-19a) Positive Results by the Power of the Spirit

1. (:18b) Acceptance of the Gospel by the Gentiles

“resulting in the obedience of the Gentiles by word and deed,”

Frank Thielman: The *obedience* that Paul speaks of here probably includes both believing the gospel (1:5; 10:16) and living in a way that is pleasing to God (6:16), and the “word” and

“*work*” that brought about this obedience is probably the preaching of the gospel (cf. **10:17**) and the signs and wonders that accompanied this preaching (**15:19**; cf. **2 Cor 12:12**; **Gal 3:5**).

James Dunn: It was this Christ who was the authority behind both Paul’s gospel and Paul’s mission (in Paul’s eyes the two were one anyway; hence again the tight cohesion of the central block of the letter with the personal explanations on either side of it). And not only the authority, remote and exalted in a distant heaven, but the one who was in fact acting through Paul. This is why Paul could boast, because he could take no credit for what he had done. And what Christ had done, and not just Paul, was to work “*for the obedience of the Gentiles*.” The recall of a key motif from **1:5** is no doubt deliberate since it ties together precisely a key theme of Jewish covenant self-awareness (obedience) and Paul’s outreach to the Gentiles: it is precisely Paul’s claim that the obligations of the covenant were being fulfilled in the faith response of the Gentiles.

John Piper: **The deeds have a supporting role.** They are not the direct means of saving people the way the word is. Deeds cannot tell the story of the death and resurrection of Christ with its saving meaning. Only words can. So the deeds have value as they confirm the word. That’s the way Luke explained the relationship between word and deed in **Acts 14:3**. Paul and Barnabas were in Iconium, and Luke says, “*So they remained for a long time, speaking boldly [word!] for the Lord, who bore witness to the word of his grace, granting signs and wonders to be done by their hands [deeds!]*.” God bore witness to the word of his grace. That was the function of the deeds. They witness to the truth and value of the word.

2. (:19a) Authenticating Manifestations of the Power of the Spirit
“*in the power of signs and wonders, in the power of the Spirit;*”

Thomas Schreiner: Paul’s “*signs and wonders*” refer to the miracles that attested to the truth of the gospel he proclaimed (cf. **2 Cor. 12:12**; cf. also **Acts 2:43**; **4:30**; **5:12**; **6:8**; **14:3**; **15:12**; **Heb. 2:4**). In other words, the signs and wonders are designed to bring about the obedience of the gentiles. The terms “*signs*” and “*wonders*” reach back to the exodus, in which God’s salvation was accomplished with “*signs and wonders*” (**Exod. 7:3**; **Deut. 4:34**; **6:22**; **7:19**; **26:8**; **34:11**; **Neh. 9:10**; **Ps. 104:27** LXX [105:27 Eng.]; **Add. Esth. 10:9**; **Bar. 2:11**). Here the signs and wonders accomplished through Paul are tokens of the inauguration of the new age, and verify the gospel of Jesus Christ.

Douglas Moo: “*Signs and wonders*” (NIV “*miracles*”) is standard biblical terminology for miraculous acts that accompany and **give credence to God’s Word**. The phrase is especially prominent in Old Testament descriptions of the Exodus (e.g., **Ex. 7:3, 9**; **11:9–10**; **Deut. 4:34**; **Ps. 78:43**) and in the book of Acts (e.g., **Acts 2:22, 43**; **4:30**; **5:12**; **14:3**; **15:12**). Paul perhaps uses this expression to signal his importance in salvation history. God works miracles through him because he is God’s “point man” to open up the Gentile world to the gospel.

James Dunn: For the first and only time Paul gives an **overview of his missionary work**. He speaks of the power of signs and wonders, the power of God’s Spirit as characterizing the work through him. Once again the overtones and allusions would be clear to his readers: Paul’s ministry as continuous with and manifesting the same power/finger of God as every Jew knew to

have characterized the Exodus (e.g., **Exod 7:3; 8:19**); Christ's ministry through Paul in the power of the Spirit as the eschatological equivalent of the epochal ministry of Moses (cf. **Matt 12:28//Luke 11:20**). As Moses had established the first assembly/church of God in the old epoch, so Christ through Paul was now establishing the redefined people of God for the end time.

Charles Spurgeon: The power that is in the Gospel does not lie in the eloquence of the preacher, otherwise men would be the converters of souls, nor does it lie in the preacher's learning, otherwise it would consist in the wisdom of men. We might preach until our tongues rotted, till we would exhaust our lungs and die, but never a soul would be converted unless the Holy Spirit be with the Word of God to give it the **power** to convert the soul.

C. (:19b) Accomplishment of the Foundational Gospel Proclamation

*"so that from Jerusalem and round about as far as Illyricum
I have fully preached the gospel of Christ."*

Frank Thielman: He had in view neither the chronology of his travels nor the ethnicity of those to whom he preached but simply his role in taking the gospel at various times to various locations between the two geographical endpoints of Jerusalem in the east and Illyricum in the west.

John Murray: Paul had discharged his commission and fulfilled the design of his ministry within the wide area specified.

Thomas Schreiner: Paul also begins with Jerusalem because of the salvation-historical priority of the Jews (**Schnabel** 2016: 824), not because his ministry began in Jerusalem. We cannot know for certain whether Paul preached in Illyricum (roughly the area of modern Albania and former Yugoslavia). The preposition *μέχρι* (*mechri, until*) could include that area or exclude it, and thus all the verse requires is that his preaching extended near the borders of Illyricum. . .

This hardly means that every village or town had heard the gospel. Paul's strategy was apparently to plant churches in **key cities**, and from there coworkers would fan out and evangelize smaller towns (cf. Epaphras in Colossians; so **Hofius** 2002a: 2, 4). He believed that his **foundational work** was completed in the region, and thus he planned to further the work in areas where gentile churches were not yet established. Establishing churches didn't occur in a day. As **S. Porter** (2015: 281) says, "For Paul preaching the good news meant more than simply proclaiming the good news and then leaving. For Paul, preaching the good news meant trying to bring his hearers to faith in Jesus Christ and the establishment of a community of believers. This took time and effort."

Douglas Moo: Paul has brought to the divinely ordained climax his commission to plant thriving, self-reproducing churches throughout the region he has described.⁶ He is now, therefore, in a position to move on.

Bruce Hurt: *Pleroo* is also used of John the Baptist who "**fulfilled his course (of life)**" (**Acts 13:25+**). He completed His God-given assignment and so too did Paul fulfill his Gospel assignment.

Everett Harrison: How well has Paul fulfilled his task in proclaiming the gospel as a minister of Christ? He now affords his readers a glimpse into his activity over many years (v. 19b). There is no account of churches founded or the number of converts or the sufferings entailed in all this service. Paul is content to draw a great arc reaching from Jerusalem to Illyricum (a Roman province northwest of Macedonia) to mark the course of his labors. Years – perhaps as many as ten – were spent in Syria and Cilicia before his ministry in Antioch that led in turn to travels in Asia Minor and Greece and establishing congregations in those areas. Luke’s account of Paul’s final visit to Macedonia and Achaia before going up to Jerusalem for the last time is very brief (**Acts 20:1, 2**). Yet it is at least possible that a visit to Illyricum or its border was made before settling down at Corinth for the winter. The Egnatian Way would have made travel easy from Thessalonica to the Adriatic Sea. Paul mentions Illyricum probably because he was closer to Italy there than he had ever been before. We can picture him anticipating in Illyricum the day when he would be free to cross the water and set foot in Italy, making contact with the Roman church.

The statement “*I have fully proclaimed the gospel of Christ*” is not intended to mean that he had preached in every community between the two points mentioned but that he had faithfully preached the message in the major communities along the way, leaving to his converts the more intensified evangelizing of surrounding districts. His ministry in Jerusalem was brief and met with great resistance, for he was a marked and hated man for abandoning the persecution of the church that he had carried on with such vigor in Jerusalem (**Acts 9:28, 29**). But the very fact that it was attempted at all displayed his determination to fulfill that part of his commission that included Israel (**Acts 9:15**). His habit of visiting the synagogues wherever he went points in the same direction.

III. (:20-21) REFLECTING ON PAST MINISTRY REINFORCES OUR AMBITION

A. (:20) Paul’s Ambition as a Gospel Pioneer

“And thus I aspired to preach the gospel, not where Christ was already named, that I might not build upon another man’s foundation;”

Denney: The duty of an Apostle was with the **foundation**, not the **superstructure**. **I Cor. iii. 10.**

William Hendriksen: Paul considered himself to be a trail-blazer for the gospel, a pioneer missionary, a founder of churches. He *planted*. Now let an “*Apollos*” come to *water* the seeds! See **1 Cor. 3:6**. That this basic program did not in any way prevent the apostle from visiting an already flourishing congregation in order to enjoy and impart the blessings of Christian fellowship and even to preach a few sermons there, must be granted. But the apostle’s main aim was to proclaim the good tidings to those who had not yet heard this uplifting message. His ambition was to establish new foundations (churches), not to build upon someone else’s foundation.

B. (:21) Paul’s Ambition as the Apostle to the Gentiles

“but as it is written, ‘They who had no news of Him shall see, And they who have not heard shall understand.’”

Thomas Schreiner: Paul’s call to preach Christ where he has not yet been acknowledged is vindicated by **Isa. 52:15**, one of the servant songs, in which gentiles who have not heard will see and understand through the ministry of the servant of the Lord. That gentiles are intended by Isaiah is clear because the same verse says that “*he will sprinkle [i.e., cleanse from their sins] many nations*” (NIV). Paul scarcely thinks of himself as the servant in this verse, since the proclamation is “*concerning him*” (περὶ αὐτοῦ, *peri autou*), that is, the servant, Jesus. Paul’s role throughout the passage is as the **proclaimer**, the one who “*announces*” (ἀνηγγέλη, *anēngelē*) and helps people hear (ἀκηκόασιν, *akēkoasin*). Thus in the Isaiah citation Paul discerns his call to proclaim the gospel where Christ has not yet been heralded.

Grant Osborne: Paul quotes from part of **Isaiah 52:15** to show that those who had been ignorant of God’s Word would respond positively to the Messiah. Isaiah predicted how surprised the Gentile nations would be when they saw the humiliation and exaltation of God’s Servant, the Messiah. Paul uses this prophetic word to affirm the need for his missionary efforts to the Gentiles.

John Murray: This text is derived from a context in which the world-wide effects of Messiah’s sacrifice are in view and the appropriateness of the application to the apostle’s Gentile ministry is apparent. He conceives of his own work as the minister of Christ to be conducted in pursuance of this prophecy and, therefore, as not only in accord with God’s design but as specifically demanded by this Scripture.

* * * * *

DEVOTIONAL QUESTIONS:

- 1) How can we guard against becoming puffed up with pride as we experience success in gospel ministry?
- 2) Is God still authenticating His message and messengers of the gospel with miraculous signs and wonders?
- 3) Should we still place special emphasis in missionary outreach today on seeking to bring the gospel to unreached peoples and areas?
- 4) How would you define the specific spiritual calling on your life based on your spiritual gifts?

* * * * *

QUOTES FOR REFLECTION:

R. Kent Hughes: Basic to **Paul’s dream** was the obsession to preach where the gospel had not been preached, wherever that might be. He voices this explicitly in **2 Corinthians 10:16**: “. . . so that we may preach the gospel in lands beyond you, without boasting of work already done in

another's area of influence." This was an immense obsession. Other Scriptures, such as **verse 24** of our text, indicate that he even wanted to go to Spain. No one really knows why—probably because Spain and Britain were seen as the end of the world. **William Barclay** thinks it may be because Spain was the birthplace of many contemporary geniuses such as Lucan, Martial, Quintillian, and Seneca. Maybe it was simply the lure of "untold millions still untold."

We do not know exactly what Paul hoped to do, but our text tells us he hoped to visit Rome (to have some fellowship with the church he had never seen) and then catch a ship for Iberia and begin his Spanish campaign. David Livingstone was cut out of the same mold as the Apostle Paul. When Livingstone volunteered as a missionary with the London Missionary Society and they asked him where he wanted to go, he replied, "Anywhere, so long as it is forward." Paul dreamed impossible dreams. This was fundamental to the greatness of Paul as a missionary, for **dreams always precede action.**

John Courson: Regarding the miraculous –

The Holy Spirit is like steam in a locomotive. He's there to move the engine down the track—not to toot the whistle. Too many people look at the power of the Holy Spirit as a whistle-tooter, as an end in itself—but the Lord says, "*You shall receive power when the Holy Ghost comes upon you to be My witnesses*" (**Acts 1:8**). Thus, when people ask why we don't see more signs and wonders today, I say, "Go to Honduras. Go to Mexico. Go to Russia. Start evangelizing and watch and see what the Lord will do in you and the miracles that will flow through you." But even if you never see an external sign, wonder, or miracle, you're in good company. Jesus said of all of the men who had lived, John the Baptist was the greatest of them all. No man was greater—not Elijah who called down fire from heaven, not Elisha who raised the dead, not Moses who parted the Red Sea. Jesus said, "*Among them that are born of women there hath not risen a greater than John the Baptist*" (**Matthew 11:11**). And yet John did no miracle (**John 10:41**). **So if you've never performed a miracle or even seen a miracle, take heart. You're in good company.** John did no miracle but "*all things John spoke of this Man were true*" (see **John 10:41**). What Man? Jesus Christ. **Talking about Jesus** is something I can do—and so can you. Yes, I would love to have the powerful, miraculous ministry of Paul. But in the meantime, I'll try to walk in the footsteps of John the Baptist, pointing others to the Lamb of God." (**Courson, J:** Jon Courson's Application Commentary: NT. Nelson. 2004)

John MacArthur: Five virtues of a master preacher as he testifies to his own preaching ministry.

- 1) He claimed nothing but what Christ had done through him = essence of humility.**
- 2) He preached obedience to the Lord.**

He not only was humble but he was faithful. His message was obedience. In **verse 18** he says, "*I will not dare to speak of any of those things which Christ has not wrought by me to make the Gentiles obedient,*" obedient." Literally, to make the Gentiles to win obedience. He saw the message of the gospel as calling people to obedience, calling them to submission to the lordship of Christ. **Romans 1:5**, his apostleship was for obedience to the faith among all nations for His name. He preached no gospel without obedience. The message was obedience.

3) He had personal integrity. And we could say he was authentic. . .

What I have said and what I have done are the message I have preached. There is no greater deterrent to the working of the power of God than a disparity in the life of the preacher between his word and his deed. Therein is the essence of hypocrisy. There is the phony. There is the unauthentic, the one who is not genuine, the one who is not real. But it is thrilling and it is challenging to realize that here was a man whose life backed up everything he said. And Christ proclaimed the message through his preaching and through his living.

4) His work was given divine affirmation.

God authenticated the true preachers with these mighty signs and wonders by the power of the Holy Spirit. That is, when Paul preached, there were demonstrations of supernatural nature to show that the power of God was behind his ministry.

5) His work is completely fulfilled.

Now what does he mean? Well it could be translated, "*I have fully carried out the gospel of Christ.*" It can mean two things.

- It can mean I fully preached in the sense that I preached the fullness of God's gospel, I preached the fullness of truth, I preached all there was, like **Acts 20** where he says, "*I have not failed to declare unto you the whole counsel of God,*" **Acts 20:27**. It could refer to the fullness of his message.
- Or it could refer to the fullness of the range of places that he went, all the way from Jerusalem to Illyricum.

Now I personally believe that the best translation or the best understanding is **the fullness of the range rather than the fullness of the message**.

David Thompson: WE MUST CONTINUALLY STRIVE FOR A LIFE AND MINISTRY THAT PLEASES AND GLORIFIES GOD.

A God-glorifying ministry exalts Jesus Christ. 15:17-21

Fact #1 - Paul's ministry praised Jesus Christ. **15:17-18**

Fact #2 - Paul's ministry preached Jesus Christ. **15:19**

Fact #3 - Paul's ministry pioneered Jesus Christ. **15:20-21**

Bob Deffinbaugh: Paul was a man who knew how to handle **success**. There was much in his ministry of which to boast. Many Christian leaders today find much to boast about, but Paul's boasting is of another kind. Paul knows that success is the result of divine grace. His ministry was marked by divine grace. He was accredited as an apostle by signs and wonders and miracles (v. 19), but this was the work of the Holy Spirit.

Leedy Greek NT Diagrams:

Rom 15:17-21

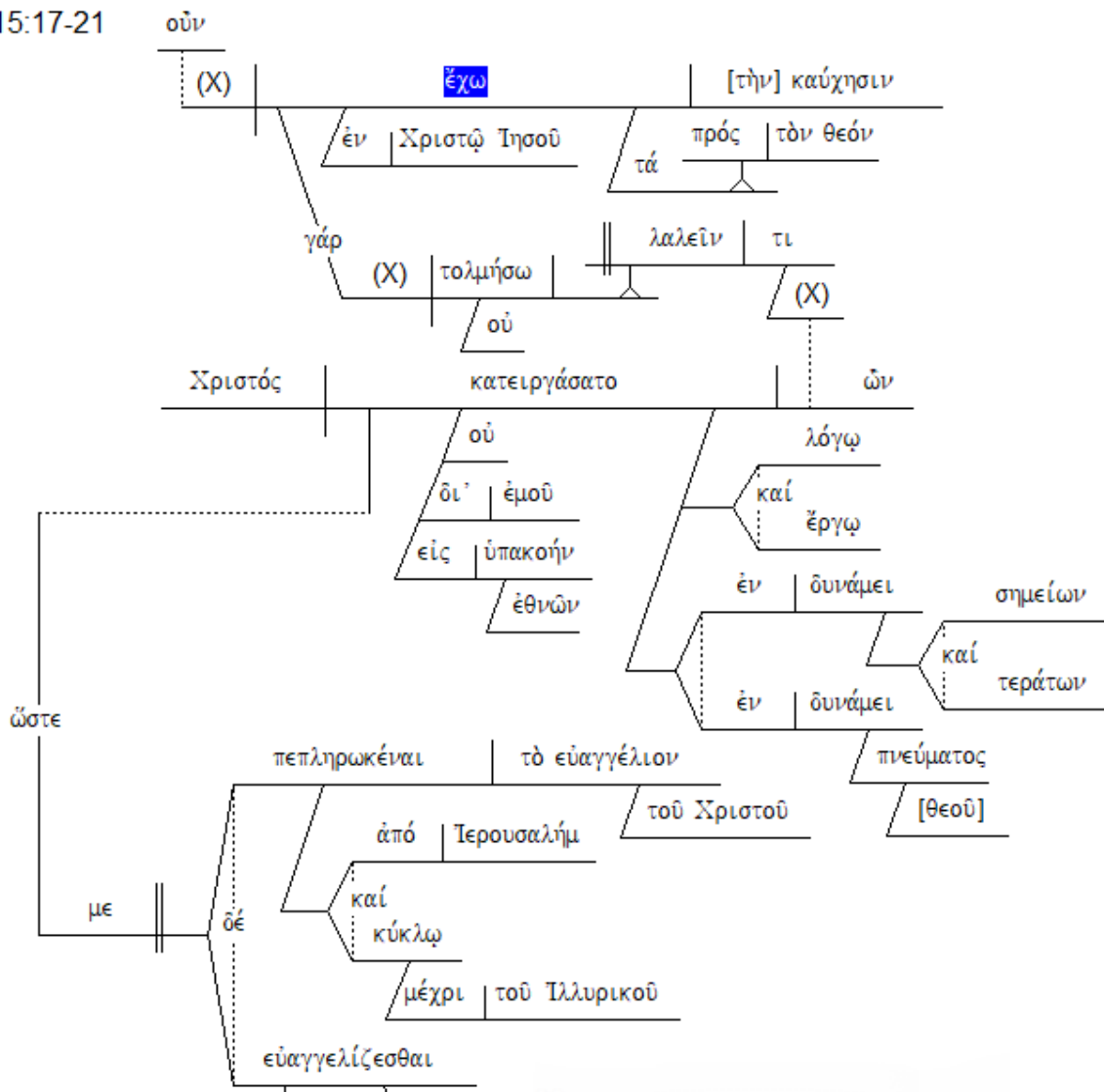

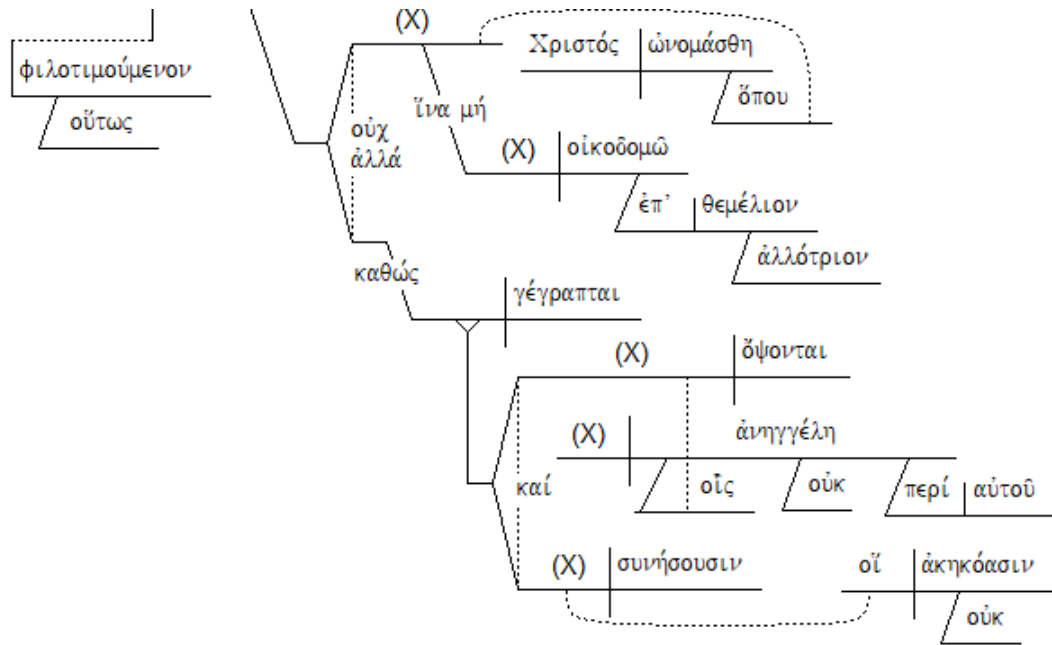

Frank Thielman:

- 17a Expansion (of 16) **I have, therefore, this reason for boasting**
- b Relationship in Christ Jesus
- c Reference with respect to the things that pertain to God.

- 18a Explanation (of 17) **For I will not dare to say anything about that which Christ did not accomplish**
- b through me
- c for the obedience of the gentiles,
- d by word and work
- 19a in the power of signs and wonders,
- b in the power of the Spirit,
- c Result (of 18a-19b) so that from Jerusalem and all around to Illyricum I have completed the preaching of the gospel of Christ

- 20a Explanation (of 19c) **And**
- b In this way been eager to preach the gospel
- c Purpose (of 20b) where Christ has not been named, in order that I might not build on another's foundation.

- 21a Verification (of 20) **But even as it is written,**
- b "Those to whom the message about him was not disclosed will see,
- c and those who have not heard will understand!" (Isa 52:15b)

TEXT: ROMANS 15:22-29

TITLE: IMMEDIATE MINISTRY PLANS – EXPRESSION OF MUTUAL FELLOWSHIP

BIG IDEA:

SPIRITUAL MINISTRY LAYS THE FOUNDATION FOR ONGOING MUTUAL FELLOWSHIP THAT RESPONDS TO MATERIAL NEEDS AND PROMOTES THE EXTENSION OF THE GOSPEL

INTRODUCTION:

Douglas Moo: Paul goes on to mention his next three destinations (in order of visit): Jerusalem (vv. 25–27), Rome (vv. 22–24, 28–29), and Spain (vv. 24, 28). He is not interested in simply giving the Roman Christians his itinerary. His main concern is to explain why it has taken him so long to get to Rome (v. 22) and why, when he does get there, he does not plan to stay long (v. 28). He must fulfill his commission to bring the gospel where the name of Christ has not yet been heard, and Spain is a fertile field for pioneer church-planting. But a stop in Rome is necessary for the apostle to secure logistical support for this new outreach, so far from his original home base of Antioch. But before these plans can be carried out, Paul must first visit Jerusalem, where he hopes to bring to a successful climax his long-cherished project of collecting money from Gentile churches for the impoverished saints in the home city of the gospel.

Thomas Schreiner: Paul returns to one of the themes in the introduction (1:13), reminding the Romans (15:22) that he was prevented from visiting them previously. The word “*therefore*” (διό, dio) gives the reason for the hindrance. Paul was busy planting churches in the area extending from Jerusalem to Illyricum (v. 19). But now this work is completed, and he is free to visit the Romans and garner support from them for his Spanish mission (vv. 23–24). Meanwhile, however, he is on his way to Jerusalem to hand over the collection for the saints (v. 25). **Verse 26** explains why there is a collection. The Macedonian and Achaian churches have been pleased to make a contribution. In **verse 27** Paul explains (γάρ, gar, for) why such a contribution is only right. These gentiles have received spiritual blessings from the Jews, and thus it is appropriate that they in turn share their material riches. After the gift is securely deposited with the saints in Jerusalem, Paul will visit Rome on his way to Spain (v. 28). He is convinced that his arrival in Rome will be with the fullness of Christ’s blessings (v. 29).

Everett Harrison: The contemplated trip to Spain by way of Rome will have to be postponed until another mission is accomplished, namely, his impending visit to Jerusalem. So three geographical points lie commingled in the mind of the apostle: Rome as the goal of much praying, hoping, and planning; Jerusalem as the necessary stop on the way; and Spain as the ultimate objective. One can see how necessary the journey to Jerusalem was in his thinking, since otherwise the lure of the West might take precedence over everything else. So Paul explains just how important this trip to the mother church is, that his readers will understand that he is not dilatory about visiting them.

I. (:22-24) THE DESIRE FOR MUTUAL FELLOWSHIP DRIVES OUR MINISTRY PLANS

A. (:22) Priorities Impact Our Ministry Plans

“For this reason I have often been hindered from coming to you;”

John Murray: In **verse 22** we have a virtual repetition of what Paul had said at **1:13**. The significant difference is that now he tells the **reason** why he had been so many times hindered from fulfilling his purpose to go to Rome. This is the force of “*wherefore also*”. He was hindered by the necessities of fulfilling his ministry in the regions more adjacent. He could not leave until he had fully preached the gospel in the territories in which up to date he had labored. “*But now*” (**vs. 23**) the case is different.

Frank Thielman: Despite his strong desire to come to Rome (cf. **1:13; 15:23**), he had not been able to go there because of his dedication to establishing Christ-worshiping communities between Jerusalem and Illyricum. . .

What were those **hindrances**? Paul probably thought especially of the physical suffering he had endured as he proclaimed the gospel and instructed new believers in various places (**1 Cor 4:9–13; 2 Cor 4:7–12; 6:4–10; 11:23–33; 12:10; 1 Thess 2:2**). Since he was writing from Corinth just before taking his relief collection to Jerusalem (**15:25–28**), he may also have had especially in mind his recent, turbulent relationship with the Corinthian church (**1 Cor 4:18–20; 2 Cor 1:23–2:13; 6:11–12; 7:2–16; 10:1–13:10**), not least in connection with persuading the Corinthians to follow through on their original commitment to contribute to that collection (**2 Cor 8:10–11**).

Douglas Moo: Paul has two reasons to come to Rome:

- a negative one (the hindrance of ministry in the east has been removed)
- and a positive one (he longs to see them).

B. (:23a) Prospects (Opportunities) Impact Our Ministry Plans

“but now, with no further place for me in these regions,”

Frank Thielman: In light of his special assignment to take the gospel where Christ has not been named, the regions stretching northwest from Corinth to Illyricum and southeast to Jerusalem are no longer a good “fit” for him.

Second, Paul is ready to make a strategic change in the location of his service to the gentiles because of a long-held desire to visit God’s beloved and holy people in Rome (cf. **1:7, 10–11**).

John MacArthur: But you need to be on your knees before the Lord until such a time until you clearly understand your gifts and callings and know where the **opportunity** that God has for you lies. And realize, too, that it may change as life goes on. But whatever it is, know it and function within it with great **commitment** and **precision**.

I think the point I want to stress is that Paul never felt, and Jesus never felt that they had to do everything in the world that could possibly be done, but rather to function with limits on the ministry consistent with the **will of God**. . .

Trusting in the providence of God is no excuse for a lack of planning, or a lack of purpose, or a lack of direction, or a lack of goals. There are those people who want to sit back and say, “Well, we’re just going to let the Holy Spirit lead.” That’s a poor excuse for laziness. Let me tell you something; I believe in the leading of the Holy Spirit, but effective ministry just doesn’t happen without very careful planning and strategizing. “*Man makes his plans*” – **Proverbs 16** says – “*but God directs his steps.*” But man makes his plans. I mean we spend a lot of time around here planning. Things happen because we plan. . .

So a life of **ministry in the will of God** involves precision and providence and planning, priority and prosperity.

C. (:23b-24) **Providence Impacts Our Ministry Plans**

“and since I have had for many years a longing to come to you 24 whenever I go to Spain-- for I hope to see you in passing, and to be helped on my way there by you, when I have first enjoyed your company for a while—”

Frank Thielman: Paul hopes that after an enjoyable and substantial visit with the Roman believers, they will “*send*” him “*on*” (προπέμπω) to Spain. This expression could mean anything from sending him off “with prayers and good wishes” to outfitting him with “companions, food, money, and perhaps a means for travel by sea.” In a context like this, the term typically meant to send someone on their way in safety and with emotional support. This might involve, for example, letters of introduction, native companions for travel, or simply a supportive crowd of well-wishers at the dock (e.g., **1 Macc 12:4**; **Jdt 10:15**; **Acts 21:5**; Josephus, Ant. 5.99). When Paul uses the term elsewhere, he seems to mean something more than a warm send-off: spending an entire winter in Corinth will prepare the Corinthians to send him on to Judea (**1 Cor 16:6**; **2 Cor 1:16**), and when Titus sends Zenas and Apollos on their way, this involves seeing “*that they lack nothing*” (**Titus 3:13**). Paul himself may not have been entirely sure what the Romans would do to aid his Spanish venture, but the term communicates that he hopes at least for their heartfelt support of his journey and work there.

James Dunn: The matter is **delicately broached**. He wants to “*visit*” them and “*have the full pleasure of their company for a short time,*” but he is only “*passing through*” (v **24, 28**). The sensitivities to possible misunderstanding and fear of some sort of rebuff are even more marked than in **1:11–12**. He clearly wants to avoid giving any impression whatsoever either that he is covertly seeking a position of leadership and authority among them (he is not their apostle; contrast **1 Cor 9:1–2**), or that he intends to abuse their hospitality (cf. Did. 11.4–5). In the midst of these implicit disclaimers comes the **actual request**, expressed as a hope: that they will help provision his expedition to the further west—that is, by offering some financial or personnel assistance, or as a continuing base from which communication and support would be maintained during his time in Spain. The matter is **delicate**, since Paul is in effect asking the Roman congregations to follow the pattern developed with the churches he himself had founded in the east—as to the provision both of financial support and of manpower as assistants and fellow workers. The manner in which Paul brings in the request probably indicates that the reports he had had of the Roman churches from those he knew there (**chap. 16**) had given him sufficient confidence that such a request would be well received.

John Witmer: Paul paid the Roman believers the sincere compliment that their fellowship would refresh and satisfy him spiritually (cf. **1:13**). He also wanted to impart a spiritual gift to them, thereby strengthening them (**1:11**) and to have some spiritual harvest among them (**1:13**), that is, to be able to help them grow in Christ.

II. (:25-27) THE DEBT OF MUTUAL FELLOWSHIP MOTIVATES CHRISTIAN GIVING – BETWEEN THE GENTILES IN MACEDONIA AND ACHAIA AND THE JEWS IN JERUSALEM

David Thompson: The believers had a responsibility to believing Jews. **15:25-27**

Paul was a man himself who gave to the work of God. One of the major financial projects that he personally undertook was a collection for the Jerusalem believers (**I Corinthians 16:1-4; II Corinthians 8:1- 9:15; Romans 15:25-27**).

- (Reason #1) - Because the Jews were believers. They were “*saints*.” **15:25**
- (Reason #2) - Because the Jews were poor. **15:26**
- (Reason #3) - Because the Jews were owed. **15:27**

A. (:25) Obligation to Provide for the Saints in Jerusalem

“but now, I am going to Jerusalem serving the saints.”

Thomas Schreiner: But before Paul can move west he must complete his mission in the east. The *but now* at the beginning of v. **25** repeats the *but now* at the beginning of v. **23**. *But now there is no longer a place in the east, but now I am going to Jerusalem*. The phrase indicates an important transition. Paul must round off his mission in the east by delivering a collection from the churches of Macedonia and Achaia to the poor among the holy ones (or, the saints) in Jerusalem.

B. (:26) Obligation to Provide for the Poor Among the Saints in Jerusalem

“For Macedonia and Achaia have been pleased to make a contribution for the poor among the saints in Jerusalem.”

Frank Thielman: Paul mentions the contributions of Macedonia and Achaia to the collection, but makes no mention of **Galatia** despite having raised funds for the collection there (**1 Cor 16:1**). Similarly, Luke names delegates from Macedonia, Galatia, and Asia, but no one from Achaia (**Acts 20:4**). When Paul wrote to the Romans from Corinth in Achaia (**16:1–2**), he had just been to Macedonia (**Acts 20:1–2**), and so he may have only mentioned the most recent and geographically closest contributors at the time of writing. The absence of anyone from Corinth in Luke’s list is more of a mystery, but it is possible that the Corinthians decided not to send a delegate with Paul despite contributing to the collection.

Douglas Moo: Paul initiated this enterprise on his third missionary journey, requesting contributions from the Gentile churches he had planted to be sent to Jerusalem for the believers

who were suffering from severe want (**1 Cor. 16:1–2; 2 Cor. 8–9**). In somewhat of a parenthesis, Paul now explains this “*service*” (**Rom. 15:26–27**) before continuing to discuss his plans to visit Rome (vv. **28–29**). Macedonia is the Roman province that includes important Pauline churches like Philippi and Thessalonica, while Achaia includes Corinth. Paul has requested money from them, but he makes clear that they gave of their own free will: They were “*pleased to make a contribution [koinonia]*.” *Koinonia* is the usual New Testament word for “*fellowship*” enjoyed by believers in Christ. The money sent by the Gentiles is a tangible expression of this fellowship.

John Witmer: The voluntary nature of the contribution (*koinonian*, “**fellowship**”) is stressed by the repetition of the verb *were pleased* (cf. **Rom. 15:26-27; 2 Cor. 8:10-12**). At the same time Paul recognized the churches had an obligation; indeed *they owe it to them* (lit., “*and they are debtors to them*”). This sense of moral obligation had undoubtedly prompted Paul to suggest the offering.

C. (:27) **Obligation to Provide for Those Who Have Ministered to us Spiritually**

“Yes, they were pleased to do so, and they are indebted to them.

For if the Gentiles have shared in their spiritual things,

they are indebted to minister to them also in material things.”

Thomas Schreiner: Indeed, not even the Romans are expected to contribute to the collection for the saints in Jerusalem. Paul solicits their prayers for his visit to Jerusalem but not a contribution. . . . More likely the giving of their substance signified **gentile inclusion** into the people of God. The acceptance of the gift by Jewish Christians was therefore of tremendous significance, since it symbolized the solidarity of Jews and gentiles in the people of God (cf. **Downs 2008: 15–17**), and the unity of Jews and gentiles is one of the major themes of Romans. Did Paul also believe that the collection, the symbol of gentile inclusion into the people of God, would provoke the Jews to jealousy so that they would turn and be saved? It is certainly possible that Paul hoped this would be the outcome. We know from **Rom. 11** that the conversion of the gentiles would eventually provoke the Jews to jealousy so that the latter would be saved. We have no reason to doubt, therefore, that Paul may have hoped that the collection would yield such an outcome. What we must avoid is the claim that Paul certainly believed that the consequence of the collection would be Jewish jealousy and salvation. Nowhere does Paul say this, and it is eisegesis to read it into the text.

Grant Osborne: That is, if the Gentiles had received the gospel (*spiritual blessings*) originally from Jerusalem (where Christianity began), surely they would want to offer financial help (*material blessings*) to the needy poor there.

Not only that, but Paul hoped that such generosity and caring among the churches would strengthen the ties between them. The Jerusalem church, obviously made up mostly of Jews, at first had a difficult time accepting ministry to the Gentiles (see Peter’s situation in **Acts 10:1 – 11:18**). Some were still concerned about these mostly-Gentile churches. Gentile churches helping to meet the needs of the Jerusalem church was a sure way to maintain harmony among the believers and strengthen the bond of brotherhood.

This was not the first time a collection was taken to the church in Jerusalem. About ten years earlier, Paul and Barnabas brought a collection from the church in Antioch of Syria to help the Jerusalem church during a time of famine (**Acts 11:30; 12:25**). It seems that being Christian and being poor went together if one lived in Jerusalem. Christianity was not well accepted by the Jewish authorities, and when Jews became Christians they were often cut off from family and friends. The Jerusalem church probably had little means of support, so help from the other churches was needed and greatly appreciated.

F. F. Bruce: Here indeed the question suggests itself whether the contribution was understood by Paul and by the Jerusalem leaders in the same sense. For Paul it was a spontaneous gesture of brotherly love, a token of grateful response on his converts' part to the grace of God which had brought them salvation. But in the eyes of the Jerusalem leaders it perhaps was a form of tribute, a duty owed by the daughter-churches to their mother, comparable to the half-shekel paid annually by Jews throughout the world for the maintenance of the Jerusalem temple and its services.

II. (:28-29) THE DELIGHT OF MUTUAL FELLOWSHIP SPARKS THE ANTICIPATION OF FUTURE MINISTRY – BETWEEN PAUL AND BELIEVERS IN ROME AND SPAIN

A. (:28) Anticipation of Travel to Spain

“Therefore, when I have finished this, and have put my seal on this fruit of theirs, I will go on by way of you to Spain.”

Frank Thielman: Containers holding goods for shipment, including agricultural products such as seed, were often “*sealed*” (cf. σφραγισάμενος) to make any tampering evident and to insure an intact delivery. Since Paul has used so much commercial language in this context, it is likely that this metaphor follows that pattern and refers to the **safe delivery** of the collection.

Grant Osborne: Paul was **looking forward** to taking the gospel to new lands west of Rome. But even the best-laid plans may not happen as we anticipate. Eventually Paul got to Rome, but it was after having his life threatened, becoming a prisoner of Rome, enduring a shipwreck, getting bit by a poisonous snake on the island of Malta, and landing finally in Rome under arrest (see **Acts 27–28**)! Tradition says that Paul was released for a time, and that he used this opportunity to go to Spain to preach the Good News. This journey is not mentioned in the book of Acts.

Everett Harrison: He speaks of the gift as “*this fruit*” (v. 29), probably meaning that the generosity of the Jerusalem church in dispersing the seed of the gospel to other Gentiles will now be rewarded, the offering being the fruit of their willingness to share their spiritual blessings.

B. (:29) Anticipation of Sharing the Blessing of Christ

“And I know that when I come to you, I will come in the fulness of the blessing of Christ.”

Thomas Schreiner: The thought is similar to **1:11**, where he anticipates sharing a spiritual gift with the Romans. Paul knows that ministry will occur when he comes to Rome, and both the Romans and he will be strengthened.

John Murray: This is the blessing which Christ imparts and Paul is convinced that his presence in Rome would be accompanied by the fullness of this blessing. No term could more appropriately express the full measure of the blessing anticipated. We are liable to think of the rich blessing that would accompany his ministry. This is without doubt in view. But we may not restrict the thought thus. The terms indicate that he will come thither in the possession of the fullness of Christ's blessing. This evinces the confidence of Christ's abiding presence in the plenitude of his grace and power. And it is also the key to the boldness with which Paul had planned his journey to the seat of empire and to the limits of the west. Although we may not press the terms of the sentence to convey this meaning, nevertheless, we cannot exclude from Paul's total thought (cf. **1:12; 15:24**) the assurance that the fullness of Christ's blessing would also be imparted to the believers at Rome.

* * * * *

DEVOTIONAL QUESTIONS:

- 1) Where do we find the balance between aggressively planning for future activities and yet submitting to the providential will of God?
- 2) How was Paul always sensitive to the potential tensions between Jewish and Gentile believers?
- 3) What type of financial responsibility should we fulfill to those who have significantly ministered to us spiritually?
- 4) What drove the Apostle Paul to continue to press forward with his desire to bring a blessing to others?

* * * * *

QUOTES FOR REFLECTION:

Warren Wiersbe: Paul was anxious that this offering be received by the Jewish believers and be acceptable to them. He wanted to bring about, under God, a closer bond between the mother church at Jerusalem and the daughter churches in other parts of the empire. Unfortunately, there were still Jews who opposed the message of grace to the Gentiles and who wanted the Gentiles to become Jews and accept the Jewish law. (Bible students call these people "Judaizers." They followed Paul wherever he went and tried to steal his churches from him. The epistle to the Galatians was written to combat their evil works.)

S. Lewis Johnson: Now this passage, I think, throws a bit of light then on the true nature of **Christian fellowship**. It throws, also, a bit of light on the **doctrine of Christian giving**. It's not a passage in which that doctrine is set forth in detail, that's found in passages like **2 Corinthians**

8 and 9. But here we do have a very important point, and that important point is simply this; the **Apostle Paul never appealed for funds for himself.** He did not hesitate to be the intermediary for the dispensing of funds from one group to another group of believers, but he never appealed for funds for himself. That's the important principle set forth here and in other places in Paul's writings which our modern day evangelical church has almost totally forgotten. . .

The New Testament method of giving is very plain, it is dedicated, it's voluntary giving, it's sacrificial giving, it's proportionate giving, fair to the rich, fair to the poor, we give a dime, we give a dollar, we give nothing, we give as God has prospered us, cheerful giving, private giving, not storehouse tithing, but house giving, we lay by ourselves. To whom do we give? The New Testament gives us directions, we support those in the family that should be supported so that they might not be on public support, we support needy saints, we support missionaries, we support those who have taught us, we give as God has given to us. We are not limited of the tie, that's one out of one hundred possibilities, one, two, three, four, five, six, up to one hundred percent of our funds. We give like John Wesley who gave the first year he had thirty pounds for his income, he lived on twenty-eight and gave two pounds to the Lord. The next year he had sixty pounds, he lived on twenty-eight and gave thirty-two to the Lord. The next year he had ninety pounds, he lived on twenty-eight and gave sixty-two to the Lord. The next year one hundred and twenty, when Mr. Wesley died he had practically nothing. He had given away over thirty thousand pounds which was real money in those days. That's the kind of giving that God led some men to do. But you know we say these things over and over again and people just do not really get the message because so often we only hear what we really want to hear.

David Thompson: The Jews of Jerusalem were very **poor** for at least five Biblical reasons:

- 1) **Overpopulation** - many Jews moved to Jerusalem expecting Christ's return. **Acts 2:46**
- 2) **Zealousness** - they sold their homes and pooled their resources for the cause of Christ and funds were running low. **Acts 2:42-47**
- 3) **Persecution** - Paul himself had chased many of the Jews out of their homes and jobs. **Acts 8:1**
- 4) **Famine** - According to **Acts 11:27-30**, a major famine had spread through the area just a few years before this letter during the reign of Claudius.
- 5) **Taxation** - Rome heaped heavy taxes on the Jews. These were reasons for the poverty and Paul says there is a debt we owe them (**15:27**). The word "*indebted*" speaks of financial obligation.

Steven Cole: Dreaming Big for God (15:22-29)

I agree that we need to provide adequate financial resources for the time when we're no longer able to work. I also understand the need for more leisure time as we get older, especially for spending more time with grandkids before they're grown. But it seems to me that as those who are commanded by our Lord Jesus to seek first God's kingdom and righteousness (**Matt. 6:33**), we ought to think and even dream about how God might use our few remaining years on earth

for His purposes. If you no longer have to work 40-60 hours a week to earn a living, shouldn't you give some thought to how you could use at least 20-30 hours a week to help fulfill the Great Commission?

Dream big and plan for how God might use you, but submit to God's will and seek His blessing in the outworking of your plans.

1. Dream big and make plans for how God might use you (15:22-24).
2. In your planning, consider what will have maximum impact for Christ's church (15:25-28).
3. Submit to the Lord's will and seek His blessing for all your plans (15:29).

Conclusion

To take action on these verses, first ask God to show you how to spend your life (both now and in the future) in light of eternity. Don't waste your life! With Moses (Ps. 90:12), pray, "*So teach us to number our days, that we may present to You a heart of wisdom.*" He concludes that psalm with the repeated plea (90:17), "*And confirm for us the work of our hands; yes, confirm the work of our hands.*" Give some thought to what abilities and desires He has given you to use for His purpose. If you're married, talk about it with your mate. Think ahead to when you'll be 75 or 80 and dream about how you would like for God to have used you by that time. Life is short—don't waste it!

Then educate yourself about the needs of the world in light of the gospel. How can you strategically use your gifts and desires to have maximum impact for Christ's kingdom? Work out some plans that will take you in that direction. Perhaps it will be to pray for and support missionaries or national believers to reach the unreached. But for some of you, it may be to go to the unreached with the good news of the Savior who has come. Whatever you do, dream big for God and use what He has entrusted to you for His kingdom and glory!

J. Ligon Duncan: Our Concern, Desire, Purpose, and Fruit

First of all, in this passage, Paul articulates his concern for evangelism and missions and especially to reach the unreached with the Gospel. Second, I want you to see how Paul emphasizes his purpose to serve fellow believers and his purpose for fellow believers to serve fellow believers. Then, I want you to see his concern for fellowship. There's a strong emphasis on the importance of Christian community and fellowshiping with brothers and sisters in Jesus Christ on a Gospel basis. And then finally, he talks about the fruit of blessedness in this passage.

Do we have a concern that the Gospel will go and reach those who have been unreached with that Gospel? That was an aspiration of the apostle Paul and he showed that priority in the fact that he deprived himself from sweet fellowship that he would have enjoyed so that he could be out there in the fields himself sharing the Gospel. . .

The Gospel brings together people that, if you were just looking at the normal affinities and kinships of life, they would have had no desire to be with one another. But what brought them together? The Gospel did. Jesus did. And so they wanted to be together.

Leedy Greek NT Diagrams:

Rom 15:22-24

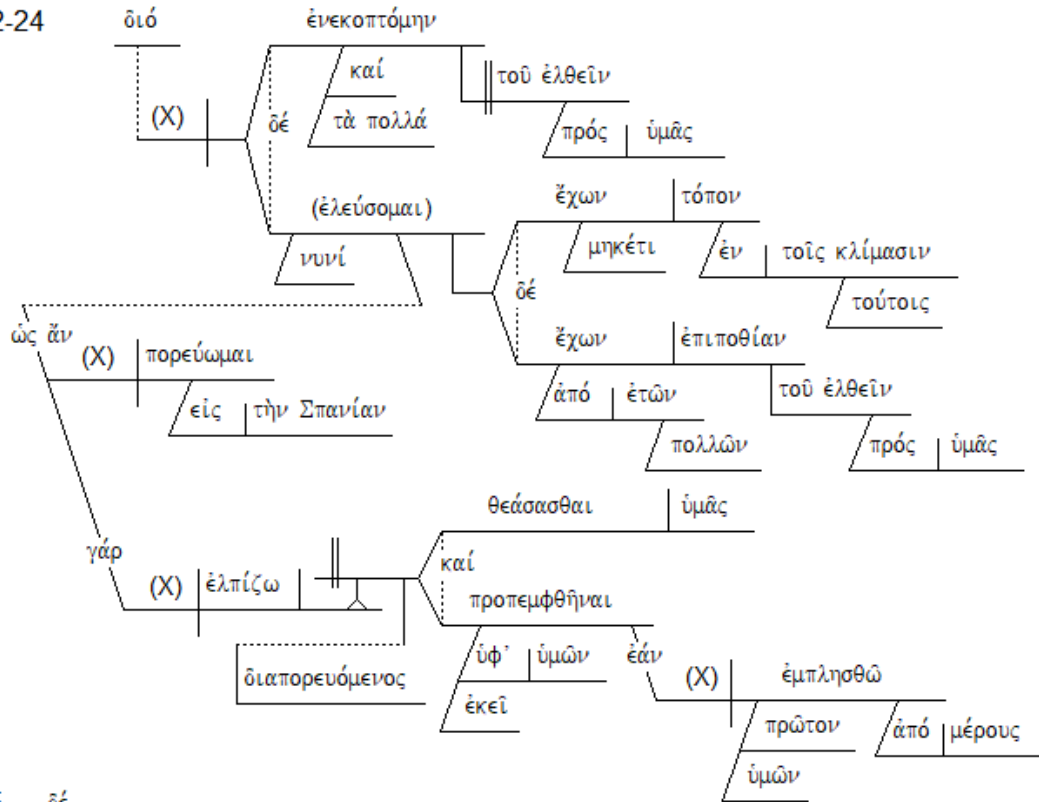

Rom 15:25

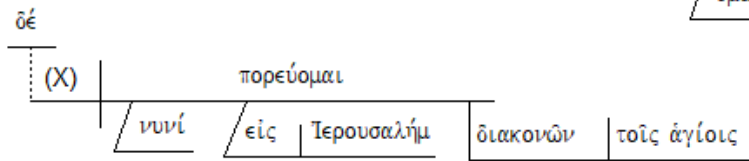

Rom 15:26

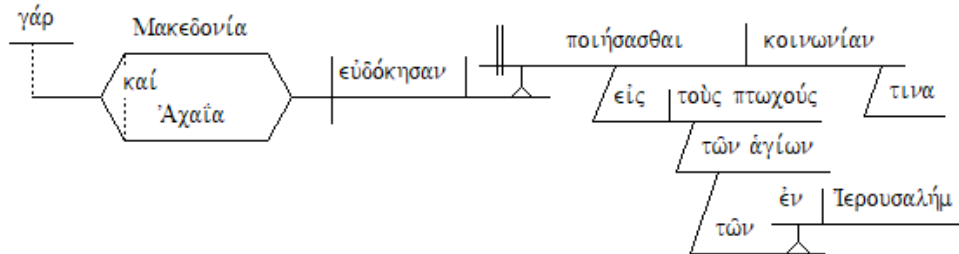

Rom 15:27

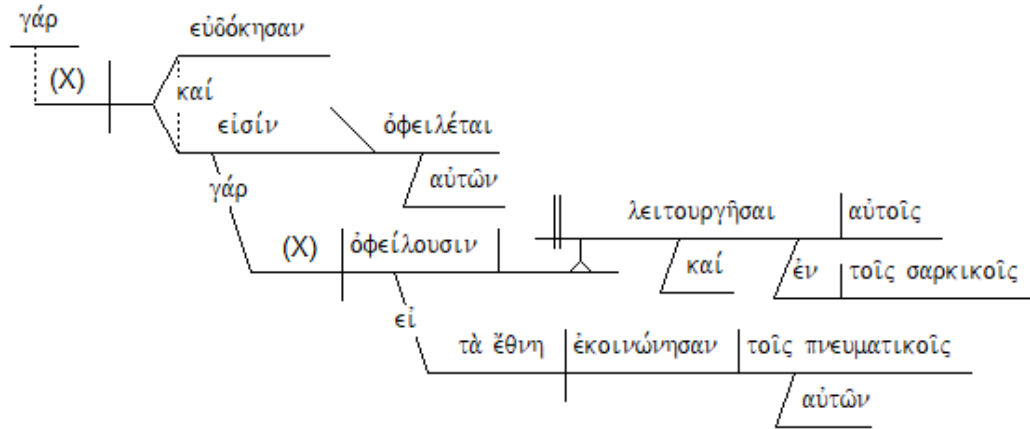

Rom 15:28-29

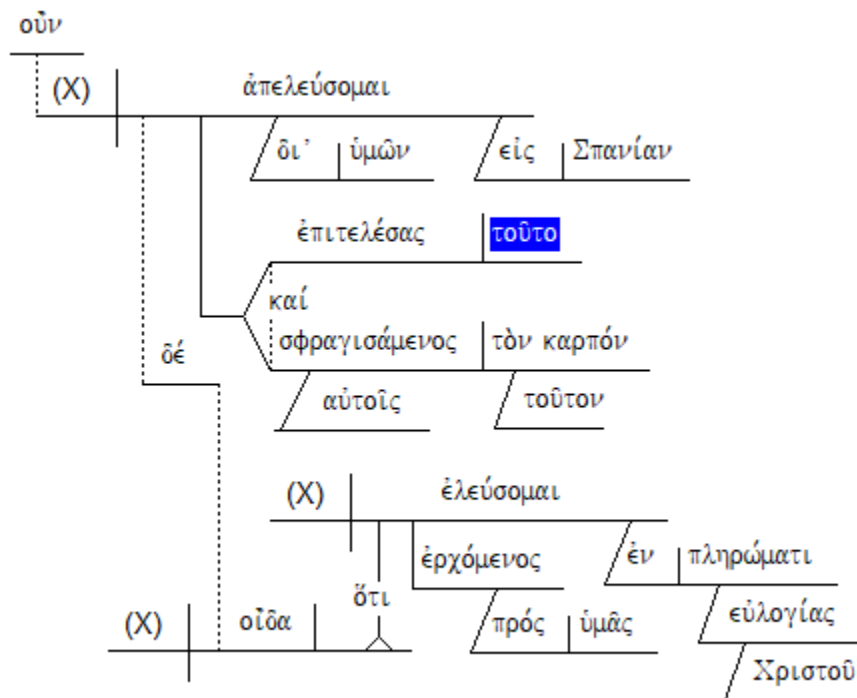

Frank Thielman:

22a	Result (of 19c)	For this reason, I was hindered
b		time and again
c		from coming to you.
23a	Contrast (to 19c, 22)	But now,
b		since I no longer have a place in these regions, and
24a		since I have a longing to come to you that goes back many years
		As soon as I go to Spain ...
		[unexpressed main verb]
b	Explanation (of 24e)	For I hope to see you as I pass through and
c		to be sent on there by you
		if I am able first to enjoy your company for a while.
25a	Contrast (to 24b)	But now
b		I am going
c		to Jerusalem
d		in order to serve the saints.
26a	Explanation (of 25)	For Macedonia and Achaia were pleased to enter into a certain partnership
b		with the poor among the saints in Jerusalem.
27a	Expansion (of 26a)	For they were pleased,
b		and they are their debtors,
c	Explanation (of 27a)	for if the gentiles have shared in their spiritual things,
d		they also are indebted to serve
e		them
f		in fleshly things.
28a	Summary (of 25-27)	Having therefore completed this obligation and
b		sealed for them this fruit,
c		I will depart for Spain via you.
29a	Assertion	And I know
b	Content	that when I come to you,
		I will come bringing Christ's total blessing.

TEXT: ROMANS 15:30-33

TITLE: PRAYER PARTNERS IN THE WARFARE OF SPIRITUAL MINISTRY

BIG IDEA:

SUCCESSFUL MINISTRY DEPENDS ON URGENT INTERCESSORY PRAYER

INTRODUCTION:

Thomas Schreiner: Paul summons the Romans to pray for the collection that is about to be delivered to Jerusalem and for his protection there. The acceptance of the collection would signify solidarity between Jews and gentiles, which by now in the letter the Romans understand to be a vital element of the Pauline gospel and a symbol that the promises made to Abraham are being fulfilled. If Paul is spared and the collection is a success, then his visit to Rome will be one of joy and rest.

John Toews: The strategic importance of the mission to Jerusalem is signaled by the way Paul describes the deliverance of the offering in v. 28—when I have completed this and have *'sealed over'* to them this fruit—and by his request for the prayers of the Roman Christians for the mission. The word for *sealed over* suggests the **secure transfer of ownership**; Paul will transfer the collection and the Jewish Christians will accept it. It is precisely “the transfer of ownership” that is so significant and at the same time filled with such great danger. Therefore, Paul *appeals* (the same word as in 12:1) to the churches *through our Lord Jesus Christ and through the love of the Holy Spirit to struggle intensely with me in prayers in my behalf to God (v. 30)*. The language of the appeal is intense and personal. It calls for the disciplined activity of contesting, even struggling, through prayer with and for Paul’s mission.

John Witmer: A Christian's intercession is a means of sharing in the ministry of others.

Steve Strauss: Reciprocal, mutual partnerships, so central to the task of missions, must emerge among churches around the world.

[Steve Strauss, "Missions Theology in Romans 15:14-33," *Bibliotheca Sacra* 160:640 (October-December 2003):474.]

Bob Deffinbaugh: Paul was a great man of prayer himself, but he coveted the prayers of the saints on his behalf. My friend, if the apostle Paul needed the prayers of the saints, we need them more today. Not only should you be praying for your own needs and the needs of those who minister at home and abroad, you also need the prayers of your fellow saints.

S. Lewis Johnson: Prayer is mysterious in its working but mighty in its power, and the apostle believed in it. The apostle of predestination, the apostle of divine election, the apostle of sovereign grace, the apostle of divine calling, the apostle of foreordination, and foreknowledge is also the apostle of fervent prayer. In his mind prayer was the means to the accomplishment of the divine purposes. And he understood prayer therefore to be absolutely essential in the work of God.

I. (:30) PLEA FOR INTERCESSORY PRAYER – WE NEED OTHERS TO SUPPORT OUR MINISTRY WITH THEIR PRAYERS

A. Mandate

“Now I urge you, brethren,”

Prayer should be our primary strategy!

Thomas Schreiner: The verb “*I appeal*” (παρακαλῶ, *parakalō*) does not represent an informal request. Thus the translation “*I ask*” (Cranfield 1979: 776) is unsatisfying inasmuch as it devalues the exhortation into a personal preference (rightly Dunn 1988b: 878). The **authority** of the request is conveyed by the grounds on which it rests. Believers in Rome are summoned on the grounds of (διά, *dia*, *through*) “*the Lord Jesus Christ*” (τοῦ κυρίου ἡμῶν Ἰησοῦ Χριστοῦ, *tou kyriou hēmōn Iēsou Christou*) and “*the love of the Spirit*” (τῆς ἀγάπης τοῦ πνεύματος, *tēs agapēs tou pneumatos*).

Thomas Constable: Paul realized that, in view of the spiritual forces antagonistic to his ministry, energetic praying was necessary (cf. **Eph. 6:18-20; 2 Cor. 1:10-11**).

B. Motivation

1. Ministry of Christ – Uniting Believers in One Body *“by our Lord Jesus Christ”*

Frank Thielman: Although Paul would have been unknown to many within the Christian community at Rome, he could make such a personal request on the basis of their common acknowledgement of the **authority** of the Lord Jesus Christ and on the basis of the **love** that the Spirit effects in the lives of believers (cf. **Rom 5:5; Gal 5:22**).

2. Ministry of the Holy Spirit – Prompting Mutual Love *“and by the love of the Spirit,”*

Michael Bird: The prayer is thoroughly **trinitarian**, taking place through Lord Jesus and through the love of the Holy Spirit and comes before God.

Ray Stedman: Prayer is born of the Spirit of God within us, awakening a desire to help, a sense of love and compassion. We pray to honor the Lord Jesus. This is what will stir people to pray more than anything else -- not beating them with a whip. I learned that long ago. It is when people begin to see that the honor of Christ is involved, and the love of the Spirit is fulfilled when you pray, that they will really begin to pray. That is what the apostle appeals to here.

C. Mutual Effort

“to strive together with me in your prayers to God for me,”

Thomas Schreiner: The verb may convey the idea of **wrestling**, as Jacob wrestled with God at Bethel (**Gen. 32:24–32**). What is communicated in this word group is that prayer involves discipline, energy, and earnestness (cf. **Luke 13:24**; Josephus, Ant. 12.2.2 §18; 17.9.3 §220;

1 Clem. 35.4). Paul calls for the Romans to partner with him in prayer because of their unity in Christ and the love that the Spirit has poured into their hearts for him.

Frank Thielman: This middle-voice term could simply mean “assist,” such as when **Josephus** used it to describe King David’s request that the people “assist” Solomon in building the temple (**Josephus**, Ant. 7.376 [**Ralph Marcus**, LCL]), but it was also often used in the **context of war**. **Diodorus Siculus**, writing in the first-century BC, for example, could use the term in an expression similar to Paul’s to describe sending Greek ambassadors to various neutral Greek cities in order “to urge [παρακαλέσοντας] them to join in the struggle [συναγωνίζεσθαι]” against the Persian invasion (**Diodorus Siculus**, Bibliotheca historica 11.3.3 [**C. H. Oldfather**, LCL]). In light of the conflict Paul hopes to avoid in Jerusalem (**Rom 15:31**), he probably meant to use a live metaphor for the formation of an alliance in the **context of a conflict**. The stakes were so high because the collection for the poor in Jerusalem was both the fulfillment of a theological debt that gentile believers owed to the Jews and a sign of the practical partnership in the gospel that gentile and Jewish Christians had with each other (**15:27**; cf. **3:22–23, 29–30; 4:11–12; 9:4–5; 11:17–18**).

Warren Wiersbe: Our praying must not be a casual experience that has no heart or earnestness. We should put as much fervor into our praying as a wrestler does into his wrestling!

II. (:31) PURPOSE OF INTERCESSORY PRAYER

A. Protect us from Opposition from Persecuting Non-believing Jews

“that I may be delivered from those who are disobedient in Judea,”

Thomas Schreiner: “*The disobedient in Judea*” (ἀπειθούντων ἐν τῇ Ἰουδαίᾳ, *apeithountōn en tē Ioudaia*) refer to non-Christian Jews who had a particular animus against Paul because he had turned against their understanding of Judaism. The book of Acts reflects the antagonism of unbelieving Jews against Paul (cf. **Acts 9:23, 29; 13:45, 50; 14:2, 5, 19; 17:5–9, 13; 18:12–17; 19:9; 20:3**). His prayer for “rescue” (ῥυσθῶ, *rhysthō*, *I should be rescued*) refers to the **preservation of his life**. This should not be interpreted as an ordinary request for life to continue. The Romans are exhorted to pray for Paul’s life because of his mission, and especially his planned trip to Rome. We also know from Acts that Paul had good reason to solicit prayers for his safety in Jerusalem. After his arrival he was assaulted and nearly killed in the temple (**Acts 21:26–36**). During his imprisonment a Jewish plot to kill him was foiled (**23:12–35**), and Paul ended up in Rome only by appealing to Caesar (**25:10–12**). Was the prayer for rescue answered? It certainly was (cf. **Murray** 1965: 222; **Stott** 1994: 390), though not in the way Paul anticipated (cf. **Schnabel** 2016: 848–49). Still, his life was preserved despite the fierceness of the opposition. Indeed, Acts emphasizes that the Jewish opposition was the means by which Paul arrived in Rome.

B. Prepare for a Positive Outcome by the Believing Jewish Church

“and that my service for Jerusalem may prove acceptable to the saints;”

Frank Thielman: Paul’s “ministry [διακονία] to Jerusalem” was Paul’s work of conveying the collection from Macedonia and Achaia to Jerusalem (cf. **2 Cor 8:4; 9:1, 12–13**). The scribe

who replaced the term translated “*ministry*” (διακονία) with a later and less ambiguous expression meaning “*bringing of presents*” (δωροφορία) captured the nuance that Paul probably intended to communicate about his role in the collection. He was a courier—a go-between—on an important “errand” (REB) for his predominantly gentile churches in the Aegean area. . .

He did not simply hope, then, that the believers in Jerusalem would **appreciate** the monetary gift he was bringing, but that they would understand and accept the **theological implications** of the collection. The collection was a demonstration that gentile and Jewish believers in Christ were unified with, and supportive of, one another as members of the people of God.

James Dunn: The fear becomes explicit in v 31. It was twofold. First, that the main body of his fellow Jews, who had not (yet) recognized what the obedience was which God now required (the obedience of faith [1:5]), would regard Paul’s breach of traditional ethnic and culturally marked boundaries as traitorous and heretical. Paul would have no illusions on this score: he himself had once shared the very same attitude (10:2; Gal 1:13; Phil 3:6); and the mounting nationalistic and religious fervor in Judea in the interval would have increased the likelihood that some group of zealots would see it as a religious duty to put Paul out of the way (cf. Acts 23:12–15). So he asks their prayers that he might be kept safe and delivered from such threats and peril to life. His second fear was that the collection might not be accepted by the Jerusalem church. The two were no doubt as closely linked in Paul’s mind as his syntax makes them: a church composed of large numbers of Jewish Christians who shared much of that nationalist and religious fervor would not take kindly (to say the least) to one who had threatened and abandoned some of the most basic beliefs and practices in terms of which Israel understood its divine calling as the people of God. And even if some of the leaders were more open to or even sympathetic to the gentile mission so much identified with Paul, the political and social pressures of a Judea beginning to gear itself for rebellion might have made it impossible to accept anything from the apostate Paul.

In view of all this the strength of Paul’s determination to deliver the collection becomes all the more impressive, and his determination to maintain the continuity and unity between the diaspora churches and Jerusalem, even at the risk of his life, can be seen in its full significance. The sharpness of the differences and the breadth of the diversity gave him no desire to break Christianity up into discontinuous entities.

John Toews: His mission is to Jerusalem, the center of Jewish faith and the location of the mother church of the Christian community. Paul fears that he will be rejected in Jerusalem and that the Jewish Christian churches will not accept the offering he brings. Nationalist zealotry is increasingly militant in Judea as developments progress toward the war of A.D. 66-70. Christians in Jerusalem were affected by this rising nationalist fervor. Any breach of Jewish group boundaries is under increasing threat. Paul’s law-free gospel for Gentile Christians represents precisely such a breach which at least representatives of the Jerusalem churches have opposed in several different regions of the Pauline mission (e.g., Galatia, Philippi). The more sharply the Jews of Jerusalem react to Paul’s presence and offering the greater the likelihood that the Jewish Christians will feel pressure to reject him and the offering. We know from **Josephus**, a Jewish historian contemporary to Paul, that the Jews of Jerusalem become so suspicious of the offerings of Gentiles to the Temple that one of the first actions after the beginning of the war in A.D. 66 was to refuse any monies from non-Jews. Paul’s mission is truly a **high risk venture**. His own

life and his vision for a unified people of God composed of Jews and Gentiles is at risk. If the Jewish Christians reject the offering, do not find it “*acceptable*,” a massive breach between the Jewish Christian and the Gentile Christian churches will have been opened, perhaps even an unreconcilable breach. Paul sees his mission to Jerusalem in salvation-history terms; it is a kairos event in the saving purposes of God.

III. (:32) POTENTIAL OF INTERCESSORY PRAYER

A. Arrival in Joy

“so that I may come to you in joy by the will of God”

John MacArthur: Pray for my safety, pray for my success and pray for the fulfillment of my plans. Pray for the ultimate goal. Pray that I'll get to Rome with joy, that I'll come with a joyful heart in the will of God and be refreshed with you.

B. Anticipation of Refreshing Fellowship

“and find refreshing rest in your company.”

Thomas Schreiner: Thus the “*refreshment*” (συναναπαύσῳμαι, *synanapausōmai*, **15:32**) envisioned is not the relaxation enjoyed during a vacation. The refreshment stems from the **fellowship** and **joy** that exist when members of the church mutually minister to one another.

(:33) BENEDICTION

“Now the God of peace be with you all. Amen.”

The presence of the **God of Peace** is needed to keep the bond of unity and fellowship among believers

Thomas Schreiner: The benediction placed here is not the sign of the end of the letter, for elsewhere Paul conveys greetings of peace before the letter comes to a conclusion (**2 Cor. 13:11**; **Phil. 4:9**; **1 Thess. 5:23**; **2 Thess. 3:16**; so **Fitzmyer** 1993c: 727; **Stuhlmacher** 1994: 244). Thus the prayer-wish here precedes the greetings found in **chapter 16**. The extensive greetings in **Rom. 16**, of course, are unusual, but their function will be explained shortly.

Frank Thielman: Paul prays that God will reconcile believers to one another across the ethnic and theological boundaries that divide them, whether in Jerusalem or in Rome.

* * * * *

DEVOTIONAL QUESTIONS:

- 1) What either motivates you or discourages you from praying?
- 2) Do we shrink back from prayer because it is hard work?

3) Do our prayers tend to focus on the mundane aspects of our own creature comforts or on the larger issues of what God is attempting to accomplish in His kingdom agenda around the world?

4) Where have you joined hands with missionaries serving in others parts of the world to support their ministry with fervent prayer?

* * * * *

QUOTES FOR REFLECTION:

Douglas Moo: Since Paul hopes that the collection will help to heal the growing rift between Jewish and Gentile Christians—a matter at the heart of his concern—he asks the Romans to join him in praying for the success of this venture. He strengthens his request by indicating that he makes it “by [the authority of] *our Lord Jesus Christ*” and on the basis of “*the love of the Spirit.*” “*Of the Spirit*” may indicate the love the Spirit has for us (a subjective genitive), but, in this context, probably means “*the love the Spirit engenders among us*” (**a genitive of source**).

Why does Paul denote this ministry of prayer as a “*struggle*”? This word may suggest that prayer involves a wrestling with God or that prayer must be especially diligent. But frequent references to his own ministry as a “*struggle*” suggest rather that he invites the Roman Christians to participate with him, through their prayers, in his missionary work.

Paul asks the Romans to pray for two things specifically (**v. 31**): that he will “*be rescued from the unbelievers* [lit., those who disobey] *in Judea,*” and that the saints in Jerusalem will accept the offering of the collection. Unbelieving Jews were especially hostile to Paul for his opening the doors of God’s people to Gentiles. His fears about them were justified, as the outcry against him when he does get to Jerusalem makes clear (**Acts 21–22**). But he is also concerned that Jewish Christians do not refuse the gift as being tainted by the “unclean” hands of Gentiles. Only when these requests have been answered will Paul be able to come to Rome “*with joy*” and be spiritually refreshed with them (**15:32**). Paul concludes his request for the Romans’ prayer with his own prayer for them: that “*the God of peace,*” that is, the God who gives peace, may be with them (**v. 33**). . .

Good and sincere interpreters will sometimes disagree on just what we can carry over from a text like this. But we need to be aware that a problem exists and not make the mistake of finding all kinds of specific points of application in a text that simply are not there. Moreover, those points of application that we do isolate probably need to be taught somewhat tentatively—unless, of course, we can find clear Scriptural support for the idea elsewhere. . .

Prayer for people involved in ministry is a . . . principle we can isolate in this text. Paul typically asks his churches to pray for him at the end of his letters. Romans is no exception. After informing the Christians in Rome about the collection he is bringing to Jerusalem (**15:25–27**), he asks them to pray for him and for the success of this venture. As we indicated in the Original Meaning section, the collection held great significance for Paul. He hoped it would become an important means of healing the growing rift between Gentile and Jewish Christians. The unity of the church was at stake. No wonder he asks for prayer.

Yet we should not miss the significance of this request.

(1) It illustrates the humility and sense of need Paul has. Though he has a divinely given mission, unique in salvation history, he still needs other believers to pray for him. How much more, then, do the rest of us, engaged in far humbler tasks and with far less biblical confirmation, need the prayers of God's people. Pride can be an obstacle here as we can subtly begin depending on our own skills, talents, or resources rather than on the Lord, who empowers through the prayers of his people.

(2) Paul's call for prayer also illustrates the biblical tension between God's determination of events and the situation-changing power of prayer. Paul undoubtedly sensed that God himself had inaugurated and was empowering this collection. Yet he still asks people to pray for it. To be sure, we have no evidence Paul saw the collection in terms of a divine prophecy, sure to succeed because God had said it would. But even if this were the case, evidence from other texts shows that he would still have asked prayer for it.

Grant Osborne: Struggling Together

Too often we see prayer as a time for comfort, reflection, or making our requests known to God. But here Paul urges believers to join in his struggle by means of prayer. Prayer is a weapon that all believers possess and should use in interceding for others. Many of us know believers who are living in difficult places in order to communicate the gospel. Sending them funds is part of joining them in their struggles. But prayer is also a crucial way of being with them. Missionaries are unanimous in desiring the prayers of those who have sent them out. Do our prayers reflect that urgency?

Steven Cole: Praying Rightly

To pray rightly, pray for the Lord's work with the right motivation, the right mindset, the right understanding, and the right relationship.

1. To pray rightly, pray for the Lord's work with the right motivation: We have great needs and a great God.

A. THE URGENCY OF NEEDS SHOULD MOTIVATE US TO PRAY.

B. THE AUTHORITY OF OUR LORD JESUS CHRIST SHOULD MOTIVATE US TO PRAY.

C. THE LOVE OF THE HOLY SPIRIT SHOULD MOTIVATE US TO PRAY.

If you love people, you'll pray for them. You pray for your kids because you love them. You pray for other family members (even if they frustrate you at times) because you love them. If you care about someone's eternal destiny, you'll pray for his salvation. If you care about a couple that is struggling in their marriage, you'll pray for them. While Paul knew many of the believers in Rome (**16:1-16**), there were many there whom he did not know. But by reading this letter to them, they could sense Paul's love for them. Even

though they had not seen Paul, the love that the Spirit put in their hearts for all who love the Lord Jesus should prompt them to pray for him. So when we hear of fellow believers who are in great need, the love of the Spirit should motivate us to pray for them.

D. BECAUSE THE GOD TO WHOM WE PRAY IS THE HEAVENLY FATHER, WE SHOULD BE MOTIVATED TO PRAY.

2. To pray rightly, pray for the Lord's work with the right mindset: Prayer is warfare.

A. STRIVE IN YOUR PRAYERS.

B. STRIVE *TOGETHER* IN YOUR PRAYERS.

John Piper has often pointed out that our prayers are often ineffective because we wrongly view prayer as calling for the butler to bring us another glass of iced tea, rather than rightly viewing it as a walkie-talkie to call in more supplies and ammunition to the front lines of the battle. In other words, our prayers should not be focused on trivial things to make us more comfortable, but rather on crucial things to advance the cause of Christ against the enemy.

3. To pray rightly, pray for the Lord's work with the right understanding: Prayer is powerful, but we must submit to God's sovereign will.

A. UNDERSTAND THAT GOD'S POWER FLOWS THROUGH OUR PRAYERS.

B. UNDERSTAND THAT GOD IS SOVEREIGN IN HOW HE ANSWERS OUR PRAYERS AND SO WE MUST SUBMIT TO HIM.

4. To pray rightly, pray for the Lord's work with the right relationship: "*The God of peace be with you all.*"

Newell: Here Paul makes the most solemn appeal for the supplications of the saints to be found in all his epistles. "Prayer changes things!" And many things needed to be wrought by God, if Paul's Divinely-guided journey to Jerusalem was to be successful.

- First, there was the inveterate hatred of the Jews toward Paul as the minister of grace to the Gentiles; the Jews were indeed "*disobedient.*"
- Second, there was the natural disinclination even on the part of Jewish Christians, through prejudice and pride, to accept for their poor an offering at the hands of Gentiles.
- Third, there was the constant willingness on the part of the Roman governors of Judea to "gain favor" with the Jews by yielding as far as possible to their demands in matters of their religion. All these difficulties had to be overcome, - and by what means? By God's appointed way-through prayer.

Leedy Greek NT Diagrams:

Rom 15:30-32

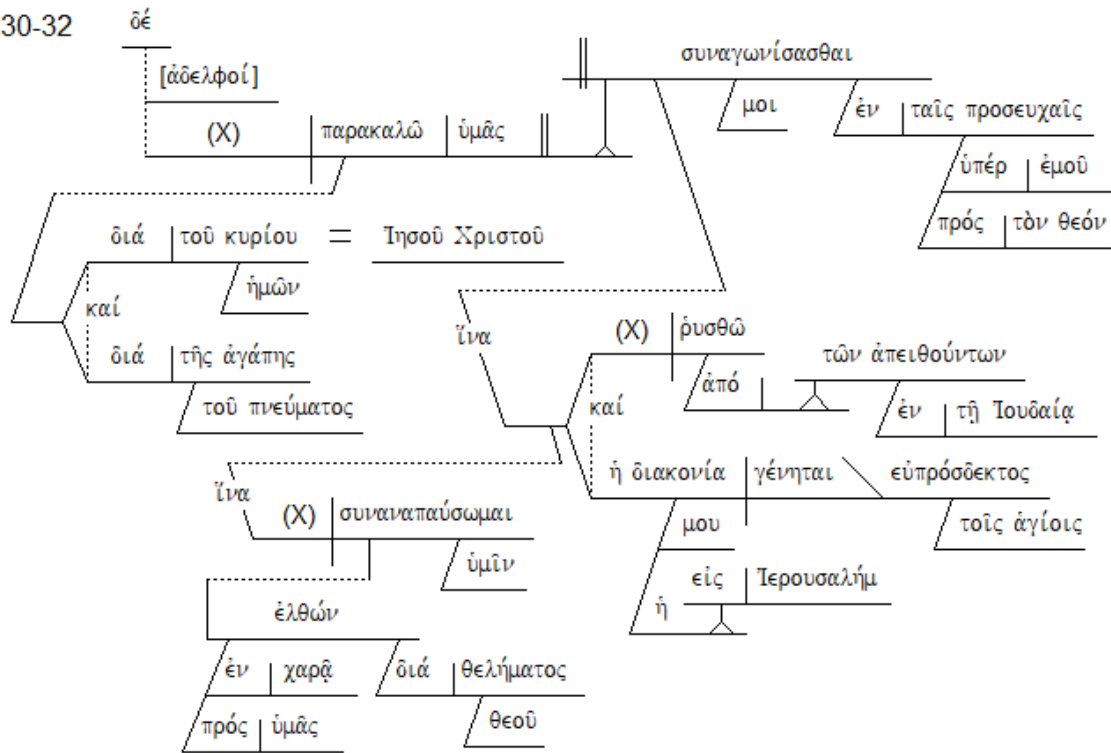

Rom 15:33

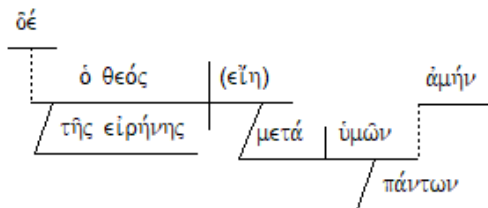

Frank Thielman:

30a	Entreaty	Now I appeal to you, brothers and sisters,
b	Basis 1 (of 30a)	through our Lord Jesus Christ and
c	Basis 2 (of 30a)	through the love of the Spirit
d	Content (of 30a)	to fight alongside me in prayers to God on my behalf
31a	Purpose 1 (of 30d)	in order that I might be rescued from the disobedient in Judea and
b	Purpose 2 (of 30d)	my ministry to Jerusalem might be acceptable to the saints
32a	Result (of 31b)	with the result that I will come to you in joy,
b	Means (of 32a)	by the will of God, and
c	Restatement (of 32a)	will rest together with you.
33	Desire	May the God of peace be with you all. Amen.

TEXT: ROMANS 16:1-2

TITLE: COMMENDATION OF THE LETTER'S COURIER – PHOEBE – THE ULTIMATE HELPER

BIG IDEA:

THE CHURCH SHOULD COMMEND AND ASSIST FELLOW CHRISTIANS WHO ARE COMMITTED TO SERVING OTHERS

INTRODUCTION:

Frank Thielman: Before releasing his audience, he observed two epistolary customs. He commended the letter's courier, and he urged his audience to greet people in their midst that he knew either personally or by reputation. This sounds rather humdrum at the formal level, but the unusual features of these standard epistolary elements demonstrate that they were intended to advance one of the primary purposes of the letter in an important, practical way. They promote the mutual, familial love that Paul has been encouraging explicitly within the Roman community since **12:1**.

Michael Bird: Paul wants his patron Phoebe to receive a warm welcome from the Roman believers and perhaps wants her personally to extend his greetings to all the persons so named as part of a "charm offensive" ahead of Paul's visit.

I. (:1) IDENTIFICATION OF THE COMMENDATION = PHOEBE

A. By Spiritual Family Relationship

"I commend to you our sister"

Thomas Schreiner: This designation means that Phoebe is a fellow believer, part of the church family. Apparently, the use of such a family term was distinctive to early Christianity, showing solidarity and mutuality. The term "*sister*" relays the intimacy and warmth characterizing the early church so that the relationship between family members describes most appropriately the affiliation between Christians (cf. **1 Tim. 5:1–2**).

B. By Name

"Phoebe,"

Frank Thielman: Phoebe carried Paul's letter to Rome, and Paul affectionately recommends her to the Roman Christians as an indispensable envoy of the Christian assembly in a busy, cosmopolitan port city just southeast of Corinth.

Everett Harrison: "*Phoebe*" means "bright" or "radiant," a well-known epithet of the Greek god Apollo.

C. By Church Role

"who is a servant of the church which is at Cenchrea;"

Thomas Schreiner: The main point of the text is that the Romans should receive Phoebe warmly not only because she is a fellow believer (which is reason enough) but also because she is well known for her service in the gospel of Christ.

Scholars debate, however, whether she held an **office**. On the one hand, the term διάκονος may be **generic**, denoting various kinds of service and assistance. On the other hand, the term also designates an **office** (cf. **Phil. 1:1**; **1 Tim. 3:8, 12**; see also Ign. Eph. 2.1; Magn. 6.1). Is Paul commending Phoebe because she held the office of deacon, or because she served in a variety of unofficial ways in the church in Cenchreae? It is impossible to be sure, but for several reasons it is likely that she held the office of deacon. First, **1 Tim. 3:11** probably identifies women as deacons (see **Schreiner** 1991c: 213–14). Second, the designation “*deacon of the church in Cenchreae*” suggests that Phoebe served in this special capacity, since this is the only occasion in which the term διάκονος is linked with a particular local church. Third, the use of the masculine noun διάκονος also suggests that the office is intended. Of course, we need to beware of reading into early church offices the full-fledged development that was realized later. But women deacons were probably appointed early, especially because other women needed assistance from those of their own sex in visitation, baptism, and other matters (cf. **Pelagius** [de Bruyn 1993: 151]).

Michael Bird: She is from Cenchreae, the eastern seaport of Corinth, before the canal was dug between the two. Phoebe is probably a merchant, perhaps a widow, with enough financial means to travel to Rome. I doubt she traveled alone, and she probably would have had escorts accompanying her, such as slaves, freedmen, friends, or relatives.

S. Lewis Johnson: I’m therefore inclined to the view that there were no official deaconesses in the early church and that this is a reference to Phebe’s **informal work of a servant of the church**. And she obviously was an outstanding Christian woman, and not only that found it very significant to be a servant of the church in the church at Rome and did her job extremely well. The apostle says, “*That ye receive her in the Lord, as becometh saints.*” So can you not imagine here arriving in the church in Rome and handing her letter of commendation, they used letters of commendation then when they traveled from place to place and they met with the saints they carried a letter of commendation from the elders in another city. I used to do that, I had letters of commendation from elders in the church of which I was fellowshiping. If I went to Houston and I was in a church there I would give them my letter and the letter would say, “Greetings in the Lord Jesus Christ, to whom it may concern, our brother S. Lewis Johnson Jr. is a Christian man in good standing in our assembly, receive him in the Lord.” And it would be signed by all the elders, four or five elders. You pass that around, letter of commendation.

John Toews: The letter of recommendation for Phoebe is both interesting and significant for the role of women in the early church. Women in antiquity were usually characterized by their relationship to men, e.g., daughter, wife, widow. Phoebe is defined by her church functions rather than her gender. She was clearly a person of means who provided leadership in the church.

James Dunn: Cenchrea, the town where Phoebe lived, was the eastern port of Corinth, six miles from the city center (see **Acts 18:18**). The church here was probably a daughter church of the one in Corinth.

II. (:2a) PURPOSES OF THE COMMENDATION

A. Receive Her Well

“that you receive her in the Lord in a manner worthy of the saints,”

Frank Thielman: Paul now gives the two purposes (ἵνα) of his commendation for Phoebe. First, he wants the Roman believers to “welcome” (προσδέξασθε) her, a term commonly used for receiving an envoy. The phrases “in the Lord” and “worthy of the saints” refer to the way those who have been united with the Lord Jesus Christ should treat others who, like themselves, have been set apart by this union as the people of God. Paul has already described what such a welcome would involve in **12:10–13**. It would mean showing Phoebe the sort of sincere, instinctive love that family members should have for one another, taking the lead in showing her respect and honor, sharing in her needs, and eagerly giving her hospitality.

B. Reciprocate by Helping Her

“and that you help her in whatever matter she may have need of you,”

Frank Thielman: Second, Paul wants the Romans to respond appropriately to the benefaction Phoebe has given to him and many others. The term “benefactor” (προστάτης) typically referred to a person, usually a man, of high social status that received clients, did them favors, and expected favors in return, especially displays of honor. Women sometimes played this role.

William Hendriksen: What kind of help would Phoebe need when she arrived in Rome, which was clearly not the place of her residence? Would it not be protection and especially hospitality? And what kind of help did those travelers need who were passing through, and stopping over at, the seaport Cenchrea, Phoebe’s home-town, proceeding from west to east or from east to west? Is it not a fact that even today such very busy junctions make strangers feel somewhat uneasy? Was not what they needed a cordial word of greeting, good advice, protection against danger and frequently even a friendly home in which to pass the night, or even the days and nights until the next ship would leave harbor on the way to their destination?

In a word it was hospitality that was needed at very busy Cenchrea. And it was hospitality Phoebe knew how to offer. Is it not probably that, like Lydia (**Acts 16:11-15, 40**), Phoebe was a well-to-do Christian lady, blessed with an alert mind and with a heart overflowing with the spirit of kindness and helpfulness? Perhaps, also like Lydia, Phoebe was a businesswoman.

III. (:2b) REASON FOR THE COMMENDATION

A. She Helped Many

“for she herself has also been a helper of many,”

Douglas Moo: Paul gives a further hint of Phoebe’s function in the church at the end of **verse 2**, where he calls her a *prostatis* “to many people, including me.” *Prostatis* is derived from a verb that means both *to care for, give aid to*, and *to direct, preside over*. The former meaning is assumed in the NIV translation, “she has been a great help.” Others argue for the latter meaning,

viewing Phoebe as the “*leader*” of the community. Perhaps the best suggestion is to give *prostatis* the meaning it often has in secular Greek, “*patron, benefactor.*” Phoebe was probably a wealthy businesswoman, who used her wealth to support the church and its missionaries (like Paul). Her ministry in the church and beneficence to the church’s workers make her worthy of a Christian greeting and any assistance the Roman church can give her.

B. She Helped the Apostle Paul
“*and of myself as well.*”

Michael Bird: Phoebe was Paul’s **benefactor**, who provided him with resources and residence in which to carry out his ministry while in the Corinthian peninsula.⁵ Clearly Phoebe was an important person in the Pauline circle. She was a household leader, financially independent, perhaps socially prominent, actively serving the Corinthian churches, and she is the one (not Timothy, Titus, or Tertius) whom Paul entrusts this important letter to be delivered to the Roman believers.

* * * * *

DEVOTIONAL QUESTIONS:

- 1) Do we highly value those who labor on behalf of the church in helper roles – often laboring behind the scenes?
- 2) Why didn’t Paul wait to personally bring this letter to the church at Rome himself?
- 3) How does this commendation highlight Paul’s view of the role of women in the early church?
- 4) What type of help do you think Phoebe provided and then needed herself?

* * * * *

QUOTES FOR REFLECTION:

James Dunn: Phoebe was a lady of some stature who had acted as patron or protector for many, that is presumably mostly, but not necessarily exclusively Christians, including Paul himself. She was also deacon of the nearby church at Cenchræe and must have used some of her means and influence in the service of the Christians there. She had business in Rome, quite probably a lawsuit. Paul probably had known ahead of her intention to travel to Rome and took the opportunity to write the whole letter, with the commendation of Phoebe attached, so that on passing through to Corinth’s western port, she could pick up the letter and carry it forward. Whatever the business Phoebe was to be engaged in at Rome, people like Prisca and Aquila, themselves of some means and influence, and others, probably freedmen in the great households of Rome, including the emperor’s, could provide a variety of help—hospitality, advice on the

current state of Roman politics and law, friendship, and Christian company. The verses therefore contain an intriguing glimpse of the combination of business affairs and social influence on which contacts between the early churches in significant part depended (in which women evidently played leading parts)—a not unimportant reminder of the historical and social realities within which Christianity first made its mark.

S. Lewis Johnson: As you look over this church in Rome, an important church no doubt because of the importance of the city, **they're primarily helpers, not leaders.** They are individuals who are in the Lord and they can sing, "Blessed be the tie that binds our hearts in Christian love, the fellowship of kindred minds is like to that above," but they are simply simple people. **A.B. Simpson** who wrote many years ago had some words to say about the needs of the church. He said, "The church of God is overrun with captains, she's in great need of a few more privates, a few rivers will not run into the sea but a far larger number run into the rivers. **We cannot all be pioneers but we can all be helpers** and no man is fitted to go to the front until he has learned well how to go second."

Some years ago I was on a platform in a theological seminary and one of the professors got up and spoke and he was talking about leadership. He told an interesting story, he said that he had read an account of a president of a large educational institution, a university in this country, one from the East. And this president had said that they had received a letter from a family that was seeking to have their son enrolled in the institution. And he said the letter was passed on to him because it was so unique. The parents gave a fairly straightforward description of their son, and then they made this significant statement, "**Our son is not a leader, but he is a good follower.**" And then the president went on to say, "In all of my years of experience in reading applications for entrance into our institution and reading and listening and hearing and reading letters from thousands of parents this is the first set of parents who ever said their son was not a leader but a follower." That's amazing, because most of us are really followers. Not leaders. Some of us like to be leaders but we're not too good at it.

Juli Camarin: I always get excited when I read about women in the Bible or see a women mentioned in the scriptures such as Phoebe. Not much detail is given about her nor is she mentioned anywhere else except in this final chapter in Romans. But she will always be remembered as the person who delivered Paul's epistle to the believers at Rome.

What an amazing task this must have been. Travel was not easy nor safe, but she was given this great letter and sent to deliver it. With it came a personal recommendation from Paul, this tells us a lot about this lady. Paul told them that she was a servant of the church in Cenchrea . . .

Paul instructed this church to help her out in whatever means necessary as she also helped others. This is an important truth that illustrates the principal of reaping what you sow. Just knowing that she helped and ministered to others in their time of need would empower the Romans to assist her while in Rome and on her journey. This is why Paul mentioned it. He instructed them that she had been a great help to others and even himself, so in the same way they should assist her when possible. Jesus said, "*Give, and it will be given to you. A good measure, pressed down, shaken together and running over, will be poured into your lap. For with the measure you use, it will be measured to you*" (**Luke 6:38**). This is a key principal of how the Kingdom of God

works, **we will reap what we sow**. So in helping others, others will be more likely to help us. Paul is advocating that Phoebe has earned their help and respect by the help she had given him.

The same holds true for us today, we are more likely to assist those who willingly help us and vica versa. Like Phoebe were are servants of Jesus and ministers to His church. We are tasks with helping and caring for our brothers and sisters when there is a need. Today, I pray that you become aware of those needs and step in and help when possible. Just like Phoebe, you will be remembered for your servant’s heart and for caring and ministering to the saints of God. May this truth bless you today as you walk in it!

<https://www.jcblog.net/romans/16/484-1-2>

Leedy Greek NT Diagrams:

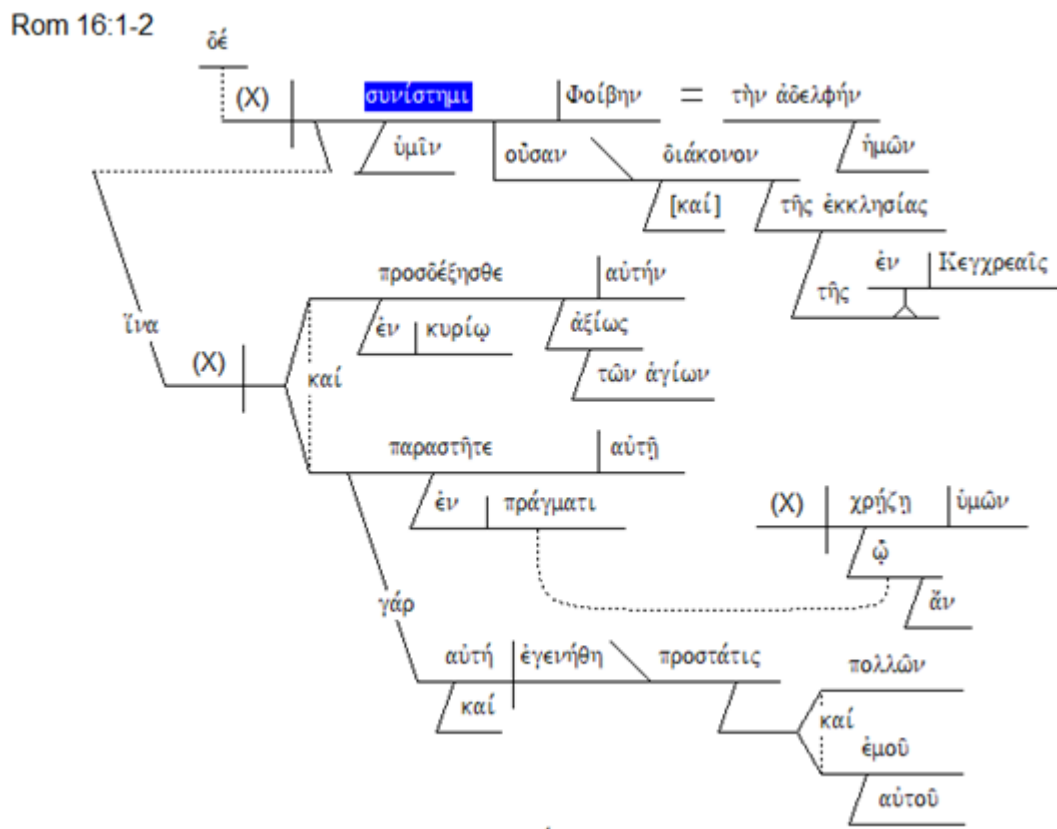

Frank Thielman:

1a Assertion	Now I commend our sister Phoebe to you,
b	who is a deacon in the assembly in Cencreae,
2a Purpose 1	in order that you might welcome her in the Lord in a way worthy of the saints and
b Purpose 2	might assist her in whatever she needs for [her] undertaking,
c Basis (for 2b)	for she also became a benefactor of many and especially of me.

TEXT: ROMANS 16:3-16

TITLE: *MULTIPLE GREETINGS -- BLESSED BE THE TIE THAT BINDS*

BIG IDEA:

FELLOWSHIP IN THE LORD BINDS BELIEVERS TOGETHER IN PRECIOUS RELATIONSHIPS AND SACRIFICIAL SERVICE

INTRODUCTION:

R. Kent Hughes: Think of the energy such “keeping in touch” involved! Imagine Paul on ship and in port beseeching travelers for information: “What about Patrobas? Where is Hermes now? Is he still walking in faith? What can I pray for?” We know from the testimony of other Scriptures that this is the way Paul was. He routed his journeys and scheduled his disciples’ travels so as to obtain as much information as possible. Paul, one of the greatest of intellects, a true master of theology, was also **a caring man who loved people.**

John Witmer: The capital city of Rome was a magnet that drew people from all over the empire. In addition Paul’s travels to many of the major population centers – Jerusalem, Syrian Antioch, Philippi, Athens, Corinth, Ephesus – brought him into contact with the mobile segment of Roman society. These factors help explain the presence of Paul’s many friends in Rome, but his knowledge of their whereabouts remains a tribute to his deep concern for people.

Grant Osborne: Rome was the capital of the empire. As Jerusalem was the center of Jewish life, Rome was the world’s political, religious, social, and economic center. There the major governmental decisions were made, and from there the gospel spread to the ends of the earth. The church in Rome was a dynamic mixture of Jews, Gentiles, slaves, free people, men, women, Roman citizens, and world travelers; therefore, it had potential for both great influence and great conflict.

The Romans had built a tremendous system of roads between the various major cities of its vast empire, so movement by people from place to place was not unusual. As Paul preached in the eastern part of the empire, he went first to the key cities—Jerusalem, Antioch in Syria, Philippi, Corinth, Athens, Ephesus. Along the way he met many believers who eventually ended up in Rome. The fact that Paul knew the whereabouts of so many of his friends and co-workers gives us a glimpse into the interest this great missionary had in the people to whom he ministered and who ministered to him. This final chapter reveals a treasury of friends Paul expected to see in Rome.

I. (:3-5A) GREETING OF PRISCA AND AQUILA – BRAVE FELLOW WORKERS

A. (:3) Identification

1. By Name

“Greet Prisca and Aquila,”

John Toews: Prisca is usually mentioned first (**Acts 18:18, 26; Rom. 16:3**) which suggests that

she is a person of higher social status than Aquila.

Grant Osborne: Behind the Scenes

Priscilla and Aquila were a couple who accomplished effective ministry behind the scenes. Their tools were hospitality, friendship, and person-to-person teaching. They were not public speakers, but private evangelists. For at least some of the Romans, their home was used for church meetings (16:5). Priscilla and Aquila give us a challenging model of what a couple can do together in the service of Christ. How often do we see our families and homes as gifts through which God can accomplish his work? How does God want to use your home and family to serve him?

2. By Church Role

“my fellow workers in Christ Jesus,”

Steven Cole: As we’ve seen in Romans, being “*in Christ*” through faith is the most important designation that can be true of anyone. Paul begins Romans 8 by stating (8:1), “*Therefore there is now no condemnation for those who are in Christ Jesus.*” He ends that chapter by saying (8:39) that there is nothing that “*will be able to separate us from the love of God, which is in Christ Jesus our Lord.*” Whether you are wealthy or poor, ordinary or important, male or female, no matter what your background, those eternal blessings are offered to you in Christ Jesus if you will trust in Him as your Savior. What a tribute to the glorious gospel that saves ordinary, diverse people from every walk of life and places them “*in Christ*”!

A. Berkeley Mickelsen: Paul starts with two of his **dearest friends** – Priscilla and Aquila. Ever since Paul had met them in Corinth on his second missionary journey, they had been hard at work in the service of God (see Acts 18:2, 18, 26).

B. (:4) Mark of Distinction

*“who for my life risked their own necks,
to whom not only do I give thanks, but also all the churches of the Gentiles;”*

John Murray: When Prisca and Aquila placed their lives in jeopardy on Paul’s account we do not know. It may have been at Corinth or at Ephesus or elsewhere. Neither are the circumstances known. Laying down their own necks could be even literally interpreted. But this may also be figurative to express the extreme peril at the hands of persecutors to which they subjected themselves to save Paul’s life. It may well be that so notable was this incident that it had been reported to all the churches of the Gentiles and that the gratitude of the churches for this act of self-sacrifice is alluded to in the latter part of verse 4.

C. (:5) Ongoing Service to the Saints

“also greet the church that is in their house.”

David Thompson: One of the main features which continually shows up with this couple is that they always had a church in their home. The early Church often met in homes because they did not have any buildings (Colossians 4:15; Philemon 2). They had one in Ephesus (I Corinthians

16:19) and they had one in Rome (16:5a). This couple loved God and they loved God’s Church.

II. (:3B-16) GREETING OF A LIST OF OTHER CLOSE MINISTRY PARTNERS

“Greet Epaphroditus, my beloved, who is the first convert to Christ from Asia. 6 Greet Mary, who has worked hard for you. 7 Greet Andronicus and Junias, my kinsmen, and my fellow prisoners, who are outstanding among the apostles, who also were in Christ before me. 8 Greet Ampliatus, my beloved in the Lord. 9 Greet Urbanus, our fellow worker in Christ, and Stachys my beloved. 10 Greet Apelles, the approved in Christ. Greet those who are of the household of Aristobulus. 11 Greet Herodion, my kinsman. Greet those of the household of Narcissus, who are in the Lord. 12 Greet Tryphaena and Tryphosa, workers in the Lord. Greet Persis the beloved, who has worked hard in the Lord. 13 Greet Rufus, a choice man in the Lord, also his mother and mine. 14 Greet Asyncritus, Phlegon, Hermes, Patrobas, Hermas and the brethren with them. 15 Greet Philologus and Julia, Nereus and his sister, and Olympas, and all the saints who are with them. 16 Greet one another with a holy kiss. All the churches of Christ greet you.”

A. Spiritual Postcards -- Expressing Love and Affection --

Fellowship in the Lord Binds Believers Together in Precious Relationships

B. Wartime Medals of Honor -- Expressing Praise for a Job Well Done --

Fellowship in the Lord Binds Believers Together in Sacrificial Service

* * * * *

DEVOTIONAL QUESTIONS:

- 1) What are the advantages and disadvantages of house churches in today’s culture here in the United States?
- 2) Why does the Apostle Paul feel it is necessary to give recognition to these particular individuals in such an important document as his letter to the church at Rome?
- 3) What type of special bond of fellowship do you experience with those believers who share close ministry responsibilities with you?
- 4) How can you testify to the preciousness of your close friends in Christian fellowship?

* * * * *

QUOTES FOR REFLECTION:

Frank Thielman: Prisca and Aquila appear six times in the New Testament and always together as a married couple (Acts 18:2, 18, 26; Rom 16:3; 1 Cor 16:19; 2 Tim 4:19). Paul uses the formal name Prisca, and Luke uses the less formal, diminutive form Priscilla.²⁸ In the two other

places where they show up in Paul's letters, he associates them with Ephesus (**1 Cor 16:19**; **2 Tim 4:19**), where a church met in their house (**1 Cor 16:19**), just as it did in Rome (**Rom 16:5**).

Paul first met Prisca and Aquila in Corinth where they discovered they had four things in common. First, they had a common connection to Judaism since Aquila, at least, was a Jew (**Acts 18:2**). Second, they shared the same trade skills in manufacturing, probably producing the linen awnings used to protect the open areas of private houses, market stalls, and certain streets and public places from the hot Mediterranean sun (**18:3**). Third, they all had recently arrived in Corinth: Paul, fresh from a journey through eastern Macedonia and northern Achaia, establishing churches (**16:9 – 17:34**), and Prisca and Aquila as exiles from Italy “because Claudius had commanded all the Jews to leave Rome” (**18:2**).

Fourth, they were all Christians. Luke does not say in so many words that Aquila and Priscilla were believers when Paul met them. He simply says that he “found” them, “went to see them,” and “stayed with them and worked” (**Acts 18:2–3**), but it is very likely that they were already Christians when they arrived in Corinth from Italy. When Paul lists the people he baptized in Corinth (**1 Cor 1:14–17**), he says nothing about Prisca and Aquila. Suetonius, moreover, ascribes the reason for Claudius's expulsion of the Jews to “disturbances at the instigation of Chrestus” (Claud. 25.4 [J. C. Rolfe, LCL]). Since the expulsion affected mainly those involved in the disturbances and since it is safe to assume that Prisca and Aquila would not riot against Christians in Rome and then support a Christian missionary in Corinth, it is very likely that they were believers before ever leaving Rome.

Paul lived and worked with Prisca and Aquila in Corinth for a year and a half (**Acts 18:11**), and all three of them left Corinth together sometime after “the Jews made a united attack on Paul and brought him before the tribunal” of the proconsul Gallio (**Acts 18:12–17**). They traveled next to Ephesus (**Acts 18:18–19**) where Prisca and Aquila stayed and taught “the way of God” (**Acts 18:26**) as Paul pressed on to Caesarea, Jerusalem, and Antioch, eventually to return to Ephesus to live and work for the next three years (**Acts 18:21–20:1, 31**). It is clear that Prisca and Aquila joined forces with Paul for part of these three years in Ephesus (**1 Cor 16:19**), but at this point they drop out of Luke's narrative. . .

When Paul wrote Romans, they must have had time to travel from Ephesus to Rome, obtain a place to live in the city, and establish an assembly of Christians in their house. Time would also be needed for a report of this house church to reach Paul in Corinth. If Prisca and Aquila left Rome shortly after Claudius's edict in AD 49 and then moved back to Rome in AD 53 or early in AD 54, they would have lived in their house for three or four years before Paul wrote Romans in AD 57 or 58.

Everett Harrison: In summary, two observations concerning the greetings should be made, since the church at Rome was destined to become the strongest in all Christendom. First, as **Lightfoot** has pointed out, several of these names appear in inscriptions of the period at Rome in reference to slaves of the imperial household. If many of Paul's friends were actually slaves, this may seem a rather inauspicious beginning for an influential church. But slaves in the Hellenistic age were often people of education and outstanding ability. Frequently they were able to gain their freedom and play a larger role in society. The very fact that at Rome believers were found in

the service of the emperor (**Phil 4:22**) augured well for the growth of the church in subsequent days. Yet it should be remembered that God’s grace, not man’s ability, is the important thing. See **1 Corinthians 1:26-31**.

Another feature of this list of names is the prominence of women in the life of the church. They occupied various stations – one a wife, another a single woman, another a mother – and all are represented as performing a valuable service for the Lord. Evidently Paul esteemed them highly for their work’s sake. His relation to them and appreciation for them makes suspect the verdict of those who would label him a misogynist on the basis of such passages as **1 Corinthians 14:34** and **1 Timothy 2:11-15**.

Leedy Greek NT Diagrams:

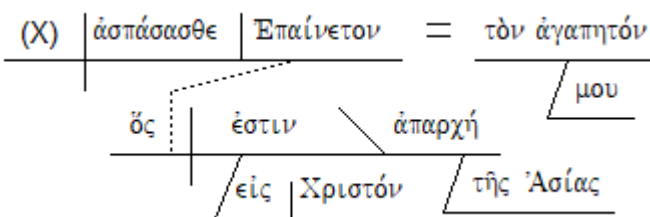
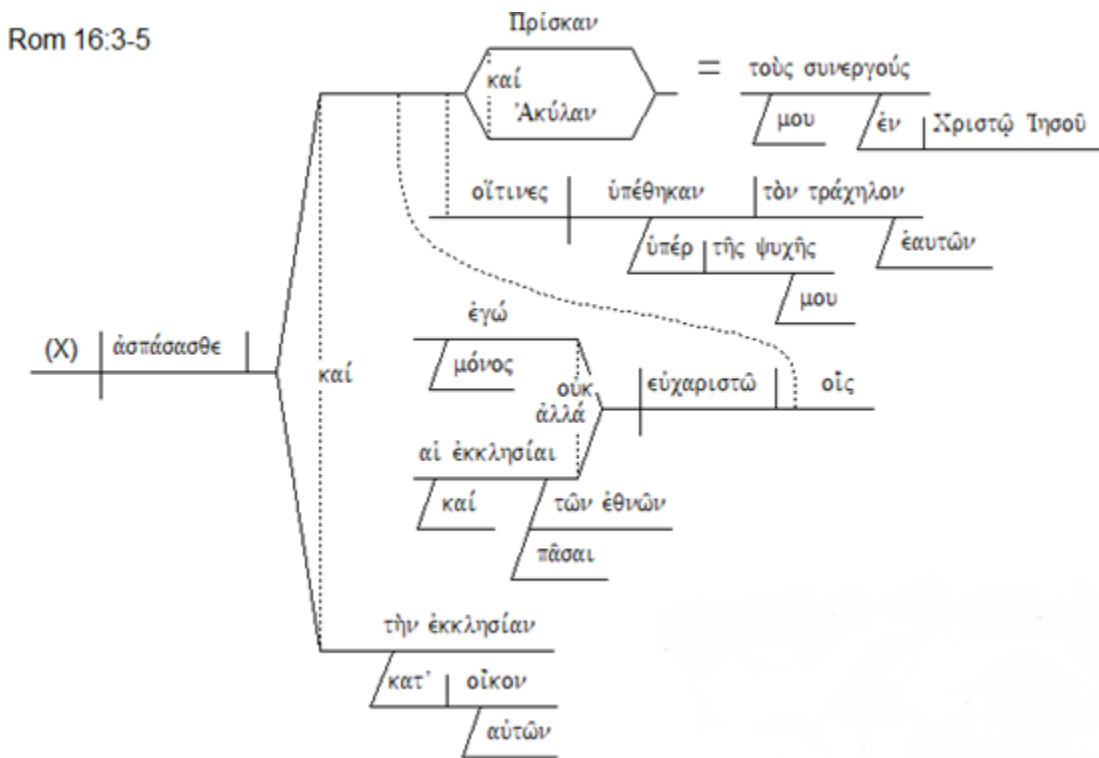

Rom 16:6



Rom 16:7

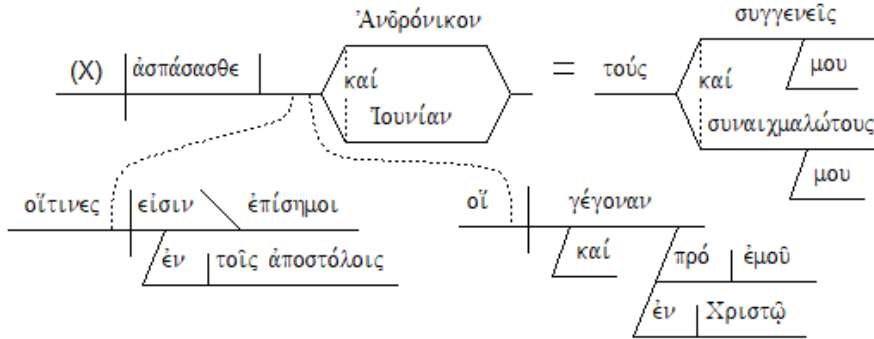

Rom 16:8

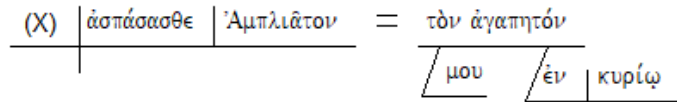

Rom 16:9

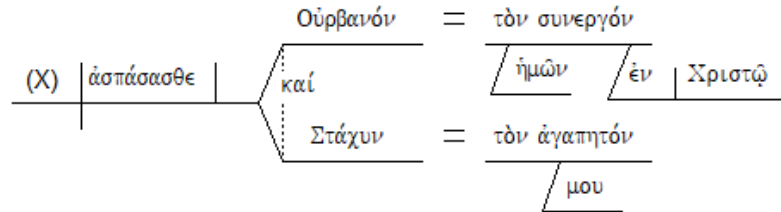

Rom 16:10

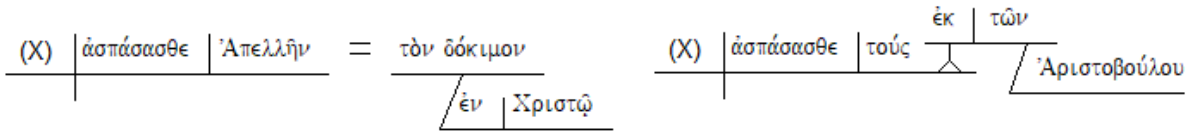

Rom 16:11

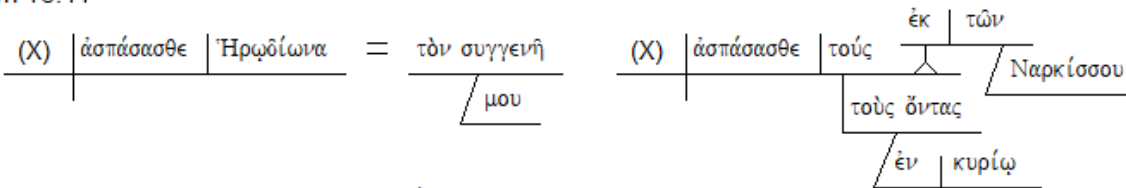

Rom 16:12

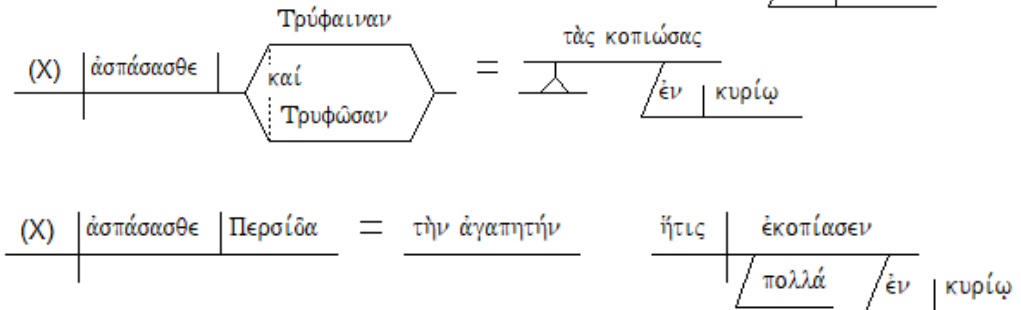

Rom 16:13

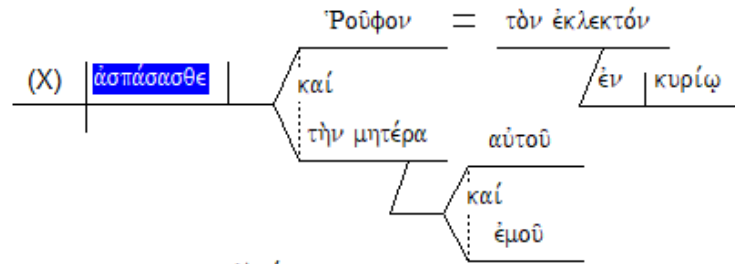

Rom 16:14

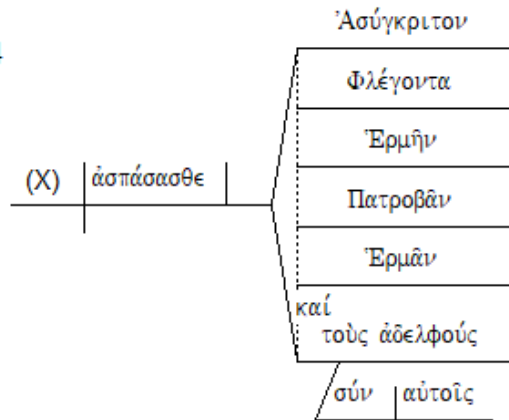

Rom 16:15

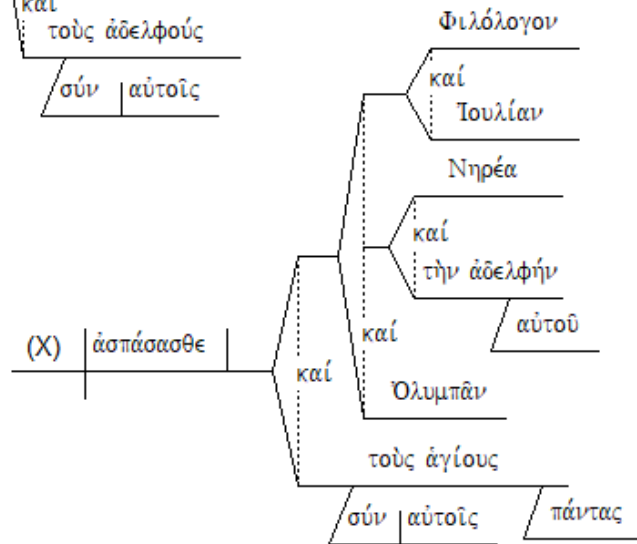

Rom 16:16

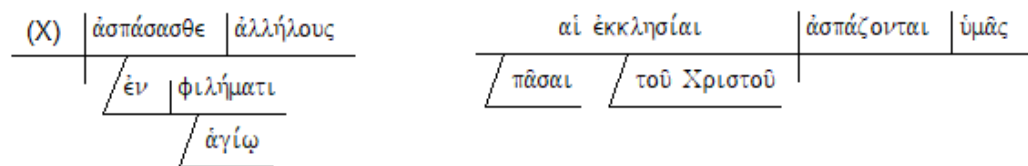

Frank Thielman:

3a Exhortation b	Greet Prisca and Aquila, my coworkers in Christ Jesus,
4a b	who laid down their own neck for my life, to whom not only I give thanks, but all the churches of the gentiles
5a Exhortation	and the church in their house.
b Exhortation c	Greet my beloved Epaphroditus, who is the first fruit of Asia for Christ.
6a Exhortation b	Greet Miriam, who has labored hard for you.
7a Exhortation b Apposition c d	Greet Andronicus and Junia, my compatriots and fellow prisoners, who are prominent among the apostles, and who were also in Christ before me.
8a Exhortation b Apposition	Greet Ampliatus, my beloved in the Lord.
9a Exhortation b Apposition/ Description	Greet Urbanus, our coworker in Christ,
9c Exhortation	and my beloved Stachys.
10a Exhortation b Description c Exhortation	Greet Apelles, tried and true in Christ. Greet those from the household of Aristobulus.
11a Exhortation b Apposition	Greet Herodion, my compatriot.

- c Exhortation
d
e
- Greet those**
from the household of Narcissus
who are in the Lord.
- 12a Exhortation
- Greet Tryphena and Tryphosa,**
those hard workers in the Lord.
- b Apposition/
Description
- c Exhortation
d
- Greet beloved Persis,**
who has worked very hard in the Lord.
- 13a Exhortation
b
c Exhortation
d
- Greet Rufus,**
chosen in the Lord,
also
his mother—and
mine.
- 14a Exhortation
b List
c
d
e
f
- Greet Asyncritus,
Phlegon,
Hermes,
Patrobas,
Hermas, and
the brothers and sisters with them.**
- 15a Exhortation
b List
c
d
e
f
- Greet Philologus and
Julia,
Nereus and
his sister, and
Olympas, and
all the saints with them.**
- 16a Exhortation
- Greet one another with a holy kiss.**
- b Assertion
- All the assemblies of Christ greet you.**

TEXT: ROMANS 16:17-20

TITLE: 4 SAFEGUARDS AGAINST DOCTRINAL TROUBLEMAKERS

BIG IDEA:

GUARD FUNDAMENTAL CHRISTIANITY AGAINST THE ATTACKS AND DECEPTION OF SELF-CENTERED TROUBLEMAKERS

4 SAFEGUARDS:

INTRODUCTION:

Frank Thielman: Paul concludes his long exposition and application of the gospel with a straightforward warning to the Roman Christians not to be deceived by any form of the gospel that takes the focus off serving Christ and puts it instead on serving evil human desires.

Thomas Schreiner: The greetings identify those in Rome who support the Pauline gospel, and Paul warmly salutes brothers and sisters in Christ (**16:3–16**). Now he warns the Romans that not everyone who claims to represent the gospel is legitimate, nor should Christian greetings be extended to all. . .

Paul envisions a potential danger threatening the Roman churches, a danger that exists until Satan is crushed under the feet of believers forever (**v. 20**). The admonition, then, is not comparable to the problems between the weak and the strong in **14:1 – 15:13**. In that text tensions between strong and weak believers in the Roman churches are adjudicated. Here a menace from outside the community is anticipated.

James Dunn: The fierceness of the sudden interjected warning in **vv 17–20** is **surprising**, and in this regard is most closely paralleled by **Phil 3:2–21** and **Gal 6:11–15**. There are too few grounds for regarding it as an interpolation . . . though stylistically it could best be regarded as a **postscript** (and so with little immediate connection with what preceded); and structurally it is most closely parallel to Paul's practice of appending a final paragraph in his own hand (**1 Cor 16:21–24; Gal 6:11–18; Col 4:18; 2 Thess 3:17**), in which he was by no means averse to a final polemical thrust (**1 Cor 16:22; Gal 6:12–13**); so, e.g., **Dodd** and **Lietzmann**. . . it is more likely that the paragraph results from Paul's realization that his preoccupation with the issue of Jew/Gentile relationships within the Roman churches had almost completely by-passed other **dangers from other quarters**.

John Toews: The first warning calls for the **critical examination** of people who **destabilize** the equilibrium (the stasis) of the churches and who erect stumbling blocks which oppose the teaching the Roman Christians have received. **Romans 6:17** and this text refer to a body of teaching passed on to the churches which has a **normative quality**, according to Paul. People who divide the churches by contradicting this teaching are to be avoided. The *stay away from them* phrase is characteristic of wisdom exhortations to avoid evil (e.g., **Ps. 34:14; Prov. 1:15; 3:7**). The reason such people are to be avoided is that they *serve their own interests* (lit., belly as a symbol for that which is fleshly and evil; so also **Phil. 3:19**) rather than our Lord Christ (**v. 18**).

This language was used elsewhere in contemporary Judaism to warn against false teaching. These false teachers deceive the *unsuspecting* (lit., without evil minds or the simple) by smooth speech and flattery.

I. (:17) CAUTION – WATCH OUT

Keep Your Distance -- Keep away from those who divide us from fellow Christians and cause us to stumble from fundamental Christianity

“Now I urge you, brethren, keep your eye on those who cause dissensions and hindrances contrary to the teaching which you learned, and turn away from them.”

James Dunn: σκοπέω has the force of “*look at carefully, consider, examine*” (cf. LSJ), “*look at critically*” (TDNT 7:414–15). Apart from **Luke 11:35** it occurs only in Paul in the NT (and only twice in the LXX)—**2 Cor 4:18; Gal 6:1; Phil 2:4; and 3:17**—and is characteristic of Paul in that it calls his readers to circumspect and responsible judgment.

Frank Thielman: “*Stumbling blocks*” (σκάνδαλα) refers to ideas, teachings, or practices that prevent progress (cf. **Rom 9:33**) and send people down the path to destruction (cf. **Rom 14:13, 20**). The two types of problems are connected: Paul warns against people who create division and *prevent progress in the faith* by injecting erroneous ideas and practices into the Christian community.

R. Kent Hughes: Heretics are to be spurned.

II. (:18) DISCERNMENT – DON’T BE DECEIVED

What You See Is Not Always What You Get -- An uncorrupted heart can be deceived by something that sounds good

“For such men are slaves, not of our Lord Christ but of their own appetites; and by their smooth and flattering speech they deceive the hearts of the unsuspecting.”

Frank Thielman: The Roman Christians should stay away from those who create divisions by their deceptive teaching because such people can use their rhetorical skill to convince others with little theological training to serve the immoral interests of the false teachers themselves. . . . He is probably describing people who use language that on the surface seems theologically correct but who draw incorrect conclusions from that language about how believers should live.²⁰ They may have, for example, waxed eloquent on the topics of “grace” and “faith,” but then perverted “*the grace of our God into sensuality*” (**Jude 4**) and failed to recognize that “*faith by itself, if it does not have works, is dead*” (**Jas 2:17**).

Thomas Schreiner: The adversaries not only serve themselves but also proselytize others. Paul worries that the “*unsuspecting*” (ἀκάκων, *akakōn*) will be deceived through their “*smooth and eloquent speech*” (χρηστολογία καὶ εὐλογία, *chrēstologias kai eulogias*). The linkage of *deceit* (ἐξαπατῶσιν, *exapatōsin*) with *Satan* (v. 20) suggests that Paul discerns Satan working

through the attractive and compelling speech of the adversaries. The Romans must be on guard because the opponents are urbane, witty, and sophisticated. They will not be unattractive boors.

James Dunn: More likely Paul in fact intends a broad and nonspecific warning (cf. **Cranfield**) to cover a number of possible eventualities, drawing on

- (1) some traditional advice from Jewish wisdom (see also on 16:19),
- (2) his experience of what can happen to congregations, as gained elsewhere and not least with regard to the church in Corinth (cf. v 17b with **1 Cor 1:10–17**; v 17c with **2 Thess 3:6**; v 18a with **Phil 3:19**; v 18b with **1 Cor 2:1–5**; **2 Cor 11:5**; and **Col 2:4**), and
- (3) his knowledge of the morally dangerous social conditions in Rome (cf. **13:12–14**).

In other words, he writes in the manner of a **parting exhortation** in which the accumulated resources of both his ancestral wisdom and his own hard-won experience serve as guidelines and warning posts for potential hazards for the servants of Christ in Rome.

Michael Bird: Paul does not hold back as he proceeds to describe the **unsavory nature** of such intruders and their strategy. . . . Paul's language here reflects what he says about his opponents elsewhere like creating dissension (**Gal 5:20**), serving their own stomachs (**Phil 3:19**), using flattering speech, (**Col 2:4**; **Eph 5:6**), and seductive teaching (**2 Thess 2:3**). It pertains to those who use religion as a means for **self-promotion**. Paul does not want the Romans to be seduced or sucked in by any charlatan using pomp to promote a non-gospel, a half-gospel, or an anti-gospel.

III. (:19) CAREFUL OBEDIENCE – LOOK BEFORE YOU LEAP

Discern first, obey second -- Rather than blind obedience

“For the report of your obedience has reached to all; therefore I am rejoicing over you, but I want you to be wise in what is good, and innocent in what is evil.”

The church at Rome has a good reputation and impact on other believing communities. Paul does not want to see that reputation and impact tarnished and diminished.

James Dunn: The vagueness and impreciseness of the language matters little: it reflects a general rather than a specific concern of Paul. And its importance lies in reminding his readers that evil can take many deceptive forms and that a combination of worldly wisdom and sensitive innocence is their best defense. Just as important here is that Paul draws his terms both from Israel's centuries-old wisdom and from the wisdom of Messiah Jesus (**Matt 10:16**)—reinforcing once again the claim made throughout the letter that the revelation of Christ and its meaning for daily living is simply an extension of the revelation given and wisdom accumulated earlier in Israel's pilgrimage.

John MacArthur: So Paul urges them, he says be very familiar with what is wisdom. Be very familiar with and knowledgeable regarding what is good, innately good. That beautiful word from which we get the name Agatha, innately good. Be good and be wise about what is good and know what is good. That's why we continually teach the Word of God. And be simple regarding what is evil. Be unlearned, be ignorant, be unsophisticated, be uninitiated. . . .

Don't study false doctrine, don't study sin, don't study error, stick with the truth and godly obedience. It's the old story of the counterfeit. If you want to know a counterfeit, just know what a true bill looks like and you'll know what a counterfeit is. **Tozer's** old story, he said, "If you had 400 pianos, how do you tune them all equally?" He said if you try to tune every piano to another piano you're going to have a problem. If you get one tuning fork, tune them all to the one tuning fork, you've got it all made. And that's the way it is in life. If we know what the standard of truth is, everything else can come in to line with that truth.

Michael Bird: There is **play on words** going on here. Paul said in **v. 18** that people who are “*naïve*” (*akakos*) get fooled by false teachers, so now in **v. 19** he wants them to aware of all that is “*evil*” (*kakos*). The chief thought is **discerning evil without getting caught up in evil**.

IV. (:20a) PERSEVERANCE IN HOPE – HANG IN THERE

God will Crush the Enemy -- Though Satan's aim is to divide and destroy our Christianity, God's aim is to soon destroy Satan to bring us peace

“And the God of peace will soon crush Satan under your feet.”

Frank Thielman: Paul promises that God will ultimately defeat the transcendent being who uses false teachers to nurture theological and moral chaos among Christians. . .

The verb “*will crush*” (συντρίψει) was used in military contexts to refer to the rout of an enemy (e.g., **Polybius**, Histories 5.47.1), and imagery from the early empire often depicted Roman emperors or armies standing over conquered peoples. The **violent idea** of crushing an enemy under foot, therefore, would have been familiar to Paul’s audience. The enemy that God will crush, however, is not the false teachers of **Romans 16:17–18** but Satan, the clever and deceptive opponent of God and his people (**2 Cor 2:11; 1 Thess 2:18; 2 Thess 2:9**), who stands behind false teaching in the church (**2 Cor 11:13–15; 1 Tim 5:15**). Paul often depicted God’s future defeat of evil by using **military imagery** drawn from the Scriptures (**2 Cor 10:3–6; Eph 6:10–17**), and that is also his procedure here.

John MacArthur: But the **God of peace** is going to end the war by bruising Satan, and there's an allusion to **Genesis 3:15**, by bruising the serpent's head. And at that time all division and discord and all lies and all sins that threaten the church, as the work of Satan, are going to be done away with and the battle waged will be over.

James Dunn: With a final flourish Paul pens a **slogan of victorious hope**: “*the God of peace will crush the Satan under your feet speedily.*” Here too the continuity with earlier and contemporary Jewish apocalyptic hope is strong: Christians share with their fellow members of God’s election the confidence of a **final triumph** of good over evil, of God over the most powerful force of evil that afflicts this world. Not only does the slogan reflect this continuity of hope, but it reflects the **eschatological expectation** which seems to have been characteristic of the Christian movement from the beginning—of the final power of God already pushing back the frontiers of evil (cf. **Mark 3:23–27; Luke 10:17–18**), of a victory already being won and soon (“*speedily*”) to be

completed. Above all, the slogan, with its echo of **Gen 3:15**, effectively ties together the whole sweep of salvation-history: God's purpose is nothing less than the complete destruction of all the evil which has grown like a large malignant cancer within the body of humankind and the restoration of his creation to the peace and well-being he originally designed for it.

(:20b) GRACE BENEDECTION

“The grace of our Lord Jesus be with you.”

Thomas Schreiner: The benediction concluding the text is aptly included here. Paul often concludes his letters with a grace benediction (**1 Cor. 16:23; 2 Cor. 13:13; Gal. 6:18; Phil. 4:23; Col. 4:18; 1 Thess. 5:28; 2 Thess. 3:18**). This benediction should be interpreted as a prayer-wish. Paul prays that the grace that called the Roman believers to Christ will continue to be theirs. Thereby they will benefit from the shattering of Satan at the end. Such a conquest cannot be ascribed to their own spirituality. Their triumph is due to the grace that is theirs through the Lord Jesus Christ.

Michael Gorman: The warning and the words of confidence lead to both a promise and a blessing (**16:20**). Paul puts the Roman situation and struggle in **apocalyptic perspective**, promising that God will soon defeat Satan, the ultimate cosmic enemy of the church and all humanity (**16:20a**; cf. *“the god of this world”* in **2 Cor 4:4**). As Ephesians puts it, *“our struggle is not against enemies of blood and flesh, but against the rulers, against the authorities, against the cosmic powers of this present darkness, against the spiritual forces of evil in the heavenly places”* (**Eph 6:12**). But at the same time, as **Martin Luther** declared (in his famous hymn “A Mighty Fortress”), echoing Paul, **“for lo! his doom is sure.”** The certainty of this defeat is therefore paired with a benediction of grace for sustenance in the struggle (**16:20b**).

John MacArthur: I know you need **empowering grace** to recognize false teaching. I know you need empowering grace to stay away from it. I know you need empowering grace to hold on in the battle until Christ defeats the enemy. And may that grace be with you. And *“amen”* means *“so let it be, may it be, may it be.”*

DEVOTIONAL QUESTIONS:

- 1) What false teaching have you had to address in your Christian circles?
- 2) Why did Paul insert this warning against false teachers right at the end of his letter?
- 3) Why can't we just assume that Christians who are exposed to false teaching will automatically be able to discern the errors and protect themselves against bad influences?
- 4) What topics receive more attention in the NT than the addressing of false teaching?

QUOTES FOR REFLECTION:

Steven Cole: A Final Warning: Beware of False Teachers!

Paul was constantly battling false teachers who hounded his steps and perverted the truth of the gospel. He was writing from Corinth, where false apostles posing as servants of righteousness had caused much damage (**2 Cor. 11:3-15**). As he thought of his many dear friends in Rome, he didn't want them to be led astray. He had heard that they were doing well in the Lord (**16:19a**), but the present is no guarantee for the future. So his love for them prompted him to insert this warning against the dangers of false teachers.

Paul's words here are totally out of sync with our current culture that holds tolerance as the chief virtue. Even many professing evangelicals argue that we should set aside all doctrinal differences, even with the Roman Catholic Church, and come together in the areas where we agree. They say, "Jesus didn't say that the world will know we are Christians by our correct doctrine, but by our love." And so they hold unity services with those who deny the gospel and other core biblical truths. In its most extreme form, they hold interfaith services with those who believe in other religions, such as Buddhism, Hinduism, and Islam. . .

Even obedient Christians need to be on guard against false teachers who deceive others for their own gain.

1. Believers need to be on guard against false teachers (16:17-18).

"*Urge*" (**Rom. 12:1; 15:30**) is a word of strong appeal. Paul is talking to believers ("*brethren*") and he shows us how to recognize these false teachers and how to respond when we encounter them.

A. RECOGNIZING FALSE TEACHERS: TO SPOT ONE YOU HAVE TO KNOW WHAT TO LOOK FOR.

(1). THE MOTIVATION OF FALSE TEACHERS IS TO PROMOTE THEMSELVES BY CAUSING DISSENSIONS AND STUMBLING BLOCKS.

(2). THE MESSAGE OF FALSE TEACHERS IS TO CONTRADICT CORE BIBLICAL TRUTH.

(3). THE MASTER OF FALSE TEACHERS IS THEIR OWN APPETITES, NOT THE LORD CHRIST.

(4). THE METHOD OF FALSE TEACHERS IS TO USE SMOOTH AND FLATTERING SPEECH TO DECEIVE THE HEARTS OF THE NAÏVE.

B. RESPONSE TO FALSE TEACHERS: KEEP YOUR EYE ON THEM AND TURN AWAY FROM THEM.

2. Even obedient Christians need to be on guard against false teachers (16:19).

3. Ultimately, it's the God of peace and His grace that protect us from falling prey to false teachers (16:20).

A. THE GOD OF PEACE IS ABLE TO CRUSH SATAN UNDER OUR FEET AS WE TRUST IN HIM.

B. THE GRACE OF OUR LORD JESUS WILL PROTECT US FROM THE ERRORS OF FALSE TEACHERS AS WE WALK CLOSELY WITH HIM.

Conclusion

J. C. Ryle was a champion for the truth in the Church of England during the 19th century. I'd recommend that you read him. In *Warnings to the Churches* ([Banner of Truth], p. 110), he wrote about how difficult yet necessary controversy in the church is. Then he added, "But there is one thing which is even worse than controversy, and that is false doctrine tolerated, allowed, and permitted without protest or molestation."

After acknowledging that many would view what he writes as exceedingly distasteful, he states (p. 111), "Three things there are which men never ought to trifle with—a little poison, a little false doctrine, and a little sin." Amen!

Ray Stedman: Responding to False Teachers

What did Paul say to do about them? Excommunicate them? Burn them at the stake? No, just avoid them. Don't listen to them. Don't pay any attention to them. Don't give them an audience. Don't let them take your time with their false ideas. I think this applies well to those zealous cultists who come around so frequently to our doors with books under their arms that claim to be explanations of the Scriptures, but which are so contrary to it in teaching and doctrine. They usually require that you join some organization, or take your counsel from some inspired teacher or center somewhere else. Paul says avoid them -- that is all... Remember, when the disciples came to Jesus very disturbed because they had found somebody who was preaching in his name and didn't belong to their group, they asked, "*What shall we do with him? Shall we call down fire on his head?*" Jesus said to them, "*Every plant that my Father has not planted will be rooted up. Let them alone,*" {cf. **Matt 15:12, 13, 14**}. Don't worry, God will take care of them. Be concerned with the positive affirmation of that which is true. Give yourself to that which is good in the Scriptures, and never mind these others. God will take care of them.

Matthew Henry: How earnest, how endearing are these exhortations! Whatever differs from the sound doctrine (**Titus 1:9**) of the Scriptures, opens a door to divisions and offences. If truth be forsaken, unity and peace will not last long. Many CALL Christ, Master and Lord, who are FAR FROM SERVING Him. But they serve their carnal, sensual, worldly interests. (**Titus 1:16**) They corrupt the head by deceiving the heart (**Mt 15:19**); perverting the judgments by winding themselves into the affections. We have great need to keep our hearts with all diligence (**Pr 4:23**). It has been the common policy of seducers to set upon those who are soft in their convictions. A pliable temper is good when under good guidance, otherwise it may be easily led astray. Be so wise as not to be deceived, yet so simple as not to be deceivers. The blessing the apostle expects from God, is victory over Satan. This includes all designs and devices of Satan

against souls, to defile, disturb, and destroy them; all his attempts to keep us from the peace of heaven here, and the possession of heaven hereafter. When Satan seems to prevail, and we are ready to give up all as lost, then will the God of peace interpose in our behalf. Hold out therefore, faith and patience, yet a little while. If the grace of Christ be with us, who can prevail against us?

David Thompson: One of the great mistakes a church can make is the mistake of thinking it is to **tolerate everyone**. It is absolutely true that the church is to patiently endure much and it is also true that most people are received and welcomed. For example, we as a church are to **welcome** sinful people. We as a church are to welcome burdened people. The church is to be a place for people who have real problems and real needs. It is to be a place that welcomes people who want to learn about God and people who are hurting or suffering. However, the church is never to welcome or tolerate someone who tampers with sound Biblical doctrine.

A CHURCH MUST IDENTIFY AND TURN AWAY FROM PEOPLE WHO CONTINUALLY CAUSE PROBLEMS CONTRARY TO SOUND BIBLICAL INSTRUCTION.

Theological unity must be protected at all costs. The church can take a lot, but it cannot and must not put up with one who tampers with God's truth. Now this basic idea comes from **verse 17**. The Greek word "*keep your eye on*" is one that means very carefully watch and look at someone. The Greek word "*turn away*" means to shun or get away from someone. What Paul is saying is that it is the responsibility of the church to fix their eyes upon a person who teaches something contrary to sound Biblical doctrine which has been taught specifically concerning the Grace of God. Paul is saying here, you get away from people who do not adhere to this and he sets forth two of their character traits:

- 1) They cause dissension in God's people. **16:17a**
- 2) They hinder growth of God's people. **16:17b**

Paul says, identify these people and turn from them.

REASON #1 – Because they are not servants of Jesus Christ. **16:18a**

REASON #2 – Because they are serving themselves. **16:18b**

These people are serving their own appetites. This indicates they are self-centered, not God-centered. They are serving their own inner drives and ambitions. These people are not really interested in understanding truth and they are not really interested in doing the will of God; they are only interested in themselves.

REASON #3 – Because they can damage the unsuspecting. **16:18c**

The third reason to spot and avoid people who do not continue to maintain sound doctrine is because they can do great harm to those who are not theologically strong or stable. They can do great damage to those who have not matured in the doctrines of the faith.

Notice false teaching affects the heart of a person. The word "*unsuspecting*" (*ακαων*) refers to those who are simple and shallow when it comes to the things of God (**Smith**, p. 16).

These confused and false teachers appear to have speech so benign but the consequences are malignant. It can destroy the faith and the heart of a person in the church.

REASON #4 – Because of what is good. 16:19

In the Greek text, Paul uses an article “*the*” before good and evil, which indicates he is referring to something specific. The specific thing to which he was referring was getting away from those who were not sound, who did not adhere to sound Biblical teaching and instruction.

A key to us becoming strong is to fellowship with others who love God’s Word and who are dedicated to it.

God never intended that His church be a place of religious toleration, especially when it came to teaching. A good God-honoring church will keep its eyes on its flock and make certain that what is being taught at every level is sound and true.

David Curtis: A Final Warning

The kind of love we hear about today is sort of a sick sentimentalism that wants to set doctrine aside in the name of so-called love. Any love that is destructive of truth, any love that is tolerant of error or propagates error, has to be shunned, because that's not the essence of real love. Real love speaks the truth in love.

I think the period of history we live in is not an easy time to be a lover of truth. For Paul, doctrine is the basis of unity. Without the common doctrine they had been taught, the unity would not have been Christian unity. So he is willing to call for truth-based disunity. Edward John Carnell put the matter in perspective when he declared, “It is better to divide over truth than to unite around error.”

Without a common commitment to the truth of the Christian faith, we are left with nothing but personal preference and the whim of the majority. And eventually a church built on personal preference will fall prey to the prevailing spirit of the age. Only a church founded on truth can truly be united.

Let me just add here that one of the greatest challenges in the quest for unity is deciding what belongs in the essential body of doctrine. What exactly is it that we divide over, and what do we agree to disagree on? For me some of the issues to divide over are: salvation by faith alone, the deity of Yeshua, the inspiration of Scripture, and the depravity of man would be on the top of my list. . .

We have some smooth-talkers in our day who promote a prosperity Gospel as a substitute to the Gospel of the crucified Christ. They talk smoothly, flattering their hearers, telling them exactly what they want to hear.

How can thousands, even millions of people, most professing to be Christians, follow some of the bogus preachers parading around their lavish stages? They are deceived by the smooth and flattering speech. They are deceived because they have not anchored their lives in the sound

doctrine common to disciples of Yeshua the Christ.

https://www.bereanbiblechurch.org/transcripts/romans_new/16_17-20.htm

Leedy Greek NT Diagrams:

Rom 16:17-18

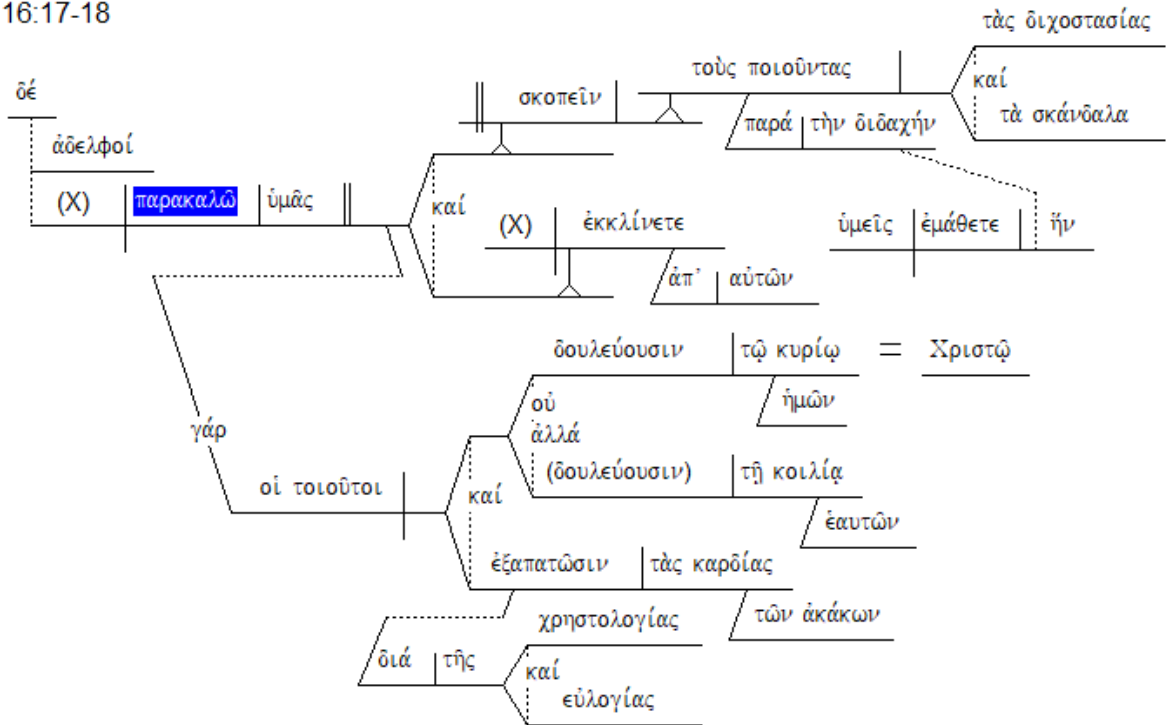

Rom 16:19

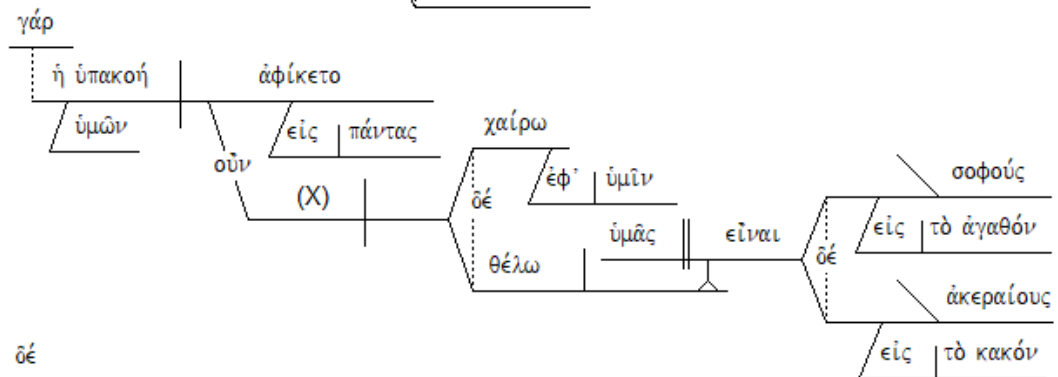

Rom 16:20

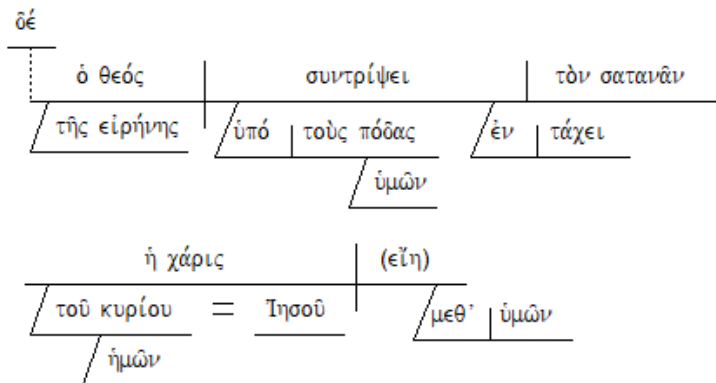

Frank Thielman:

- 17a Warning
b to look out for those who create dissensions and stumbling blocks
c
d steer clear of them. contrary to the teaching that you learned, and
- 18a Basis (of 17)
b Contrast (to 18a) For **such people are not slaves** to our Lord Christ but to their own belly,
c Means and through fine speech and blessing
d Basis (of 17) **they deceive the hearts of the unsuspecting.**
- 19a Basis (of 17)
b Result For **[the report of] your obedience has reached everyone.**
c Exhortation So **I rejoice because of you,**
d Contrast (to 19c) but **I want you to be wise with reference to what is good but pure with reference to what is evil.**
- 20a Promise
b Desire But **the God of peace will quickly crush Satan under your feet.**
The grace of our Lord Jesus be with you.

TEXT: ROMANS 16:21-27

TITLE: FINAL GREETINGS AND DOXOLOGY OF CELEBRATION OF GOD'S GLORY

BIG IDEA:

GLORY TO GOD FOR HIS WISDOM IN UNITING JEWS AND GENTILES IN A STABLE FAITH THROUGH MAKING KNOWN THE GOSPEL OF JESUS CHRIST

INTRODUCTION:

Frank Thielman: Two theological themes dominate this final section of Paul's letter.

- First, Paul speaks of the importance of preserving the unity of God's people by staying grounded in the historically reliable apostolic tradition about the Christian faith.
- Second, he describes the importance of joining together with other believers to worship God, who strengthens his people to believe and obey this faith.

Thomas Schreiner: Paul prays that God will receive the glory for the gospel that has now been revealed. This gospel was both hidden and prophesied in the OT, but the age of fulfillment has come; the mystery that was shrouded in the past is now publicly declared. The gospel centers on Jesus the Messiah, for he fulfills the saving promises of the OT, and these promises are being realized in the inclusion of all nations into the people of God. As the gentiles exercise the obedience that comes from faith, they show that they are the children of Abraham. God's saving plan, which includes Jews and gentiles and is effected through Jesus the Messiah, is wisely constructed so that he receives the glory and praise forever.

Michael Bird: The closing doxology is one of the most sublime pieces of theological prose ever composed. It reprises and amplifies the earlier doxology in Romans **11:33-36** by **celebrating God's glory** as the climax to the redemptive history embodied in gospel. It is appropriate for Paul to end the letter on this note. The biblical story began with Adam falling into sin and all of humanity thereafter failing to give glory to God because they themselves have fallen short of the glory of God (see **Rom 1:23; 3:23**). Thankfully, the rest of the story is about the reversal of this dire state since salvation is about humanity giving glory to God and sharing in the hope of glory (see **Rom 4:20; 5:2; 8:17-18, 21, 30**). The story of Romans is then a microcosm of the biblical story since Paul takes us from glory lost to glory regained. Viewed this way, the doxology represents a virtual hermeneutical key for reading Romans, summing up the themes of God, glory, Messiah, and revelation.

John MacArthur: This is an incredible thing, how Paul has managed in that doxology to capture the essence of a review of the whole of Romans. In two brief verses, **verses 25 and 26**, the reader is carried back and swept through the whole Roman epistle to review quickly the gospel which brings praise to God, the gospel which causes the doxology. It is a gospel that establishes men in righteousness who formerly were fallen in sin. It is a gospel concerning Jesus Christ who has provided for us all the necessary elements of Christian living, and it is a gospel that is a mystery revealed, that Jew and Gentile are one in a great fellowship of love which fellowship is regulated by the principles given in **chapter 9** and following. What a glorious gospel. **What a glorious gospel.**

I. (:21-23) FINAL GREETINGS

A. (:21) Timothy and 3 Fellow Jews

1. Timothy, His Chief Fellow Worker

“Timothy my fellow worker greets you,”

Frank Thielman: Luke says that Timothy was with Paul during his three-month stay in Corinth prior to Paul’s journey to Jerusalem (**Acts 19:21; 20:4**), and this was almost certainly the time at which Paul wrote Romans. According to **Acts 20:4**, Timothy was part of the group that assembled in Corinth from Macedonia, Asia, and Galatia and that traveled with Paul to Jerusalem, a journey that Paul’s correspondence indicates was for the purpose of conveying the collection for the poor among the Jewish Christians in Jerusalem (**Rom 15:25–27; 1 Cor 16:3–4; 2 Cor 8:19–21; cf. Acts 24:17**).

2. 3 Fellow Jews

“and so do Lucius and Jason and Sosipater, my kinsmen.”

Frank Thielman: Paul conveys greetings from Timothy to the Roman Christians, and perhaps especially to Prisca and Aquila. He also sends greetings from three fellow Jewish Christians, part of God’s graciously chosen Israelite remnant and perhaps also part of the delegation traveling with Paul to Jerusalem to convey the collection for the poor among the saints there. . .

There is a good probability that “Jason” was the same person who hosted Paul in Thessalonica and bailed him out of custody when he got into trouble with “**the city authorities**” (**Acts 17:5–9**). He may well have been one of the Thessalonians, in addition to Aristarchus and Secundus, who functioned as delegates from Macedonia for conveying the collection to Jerusalem. Similarly, “Sosipater” (Σωσίπατρος) is probably the same person as “*Sopater the Berean, son of Pyrrhus*” who accompanied Paul as part of the delegation from Macedonia (**Acts 20:4**). “*Sopater*” could easily be a shortened form of “*Sosipater*.”

Lucius, Jason, and Sosipater were all Paul’s “*compatriots*” (συγγενεῖς) or fellow Jews (cf. **Rom 9:3; 16:7, 11**). Like Andronicus, Junia, and Herodion (**16:7, 11**), then, they were Jewish Christians and part of God’s graciously chosen remnant. Paul may have pointed out that they were **Jewish Christians** because they served as proof to him that God’s promises to Israel had not failed (**9:6**) and that God had not cast off his people (**11:1–7**).

B. (:22) Tertius – His Secretary

“I, Tertius, who write this letter, greet you in the Lord.”

Frank Thielman: Paul seems to have frequently employed secretaries to assist him in taking down his letters since he occasionally took the pen from the person to whom he dictated a letter to make a comment in his own hand (**1 Cor 16:21; Gal 6:11; Col 4:18; 2 Thess 3:17; Phlm 19**). Only here, however, does a secretary suddenly walk onto the stage, announce his name, and speak in his own voice.

C. (:23) Gaius, Erastus and Quartus

1. Gaius, His Host

“Gaius, host to me and to the whole church, greets you.”

Frank Thielman: Paul conveys greetings from Gaius, a believer whom he had baptized on his first visit to Corinth and who generously provided a safe place in his home for Paul and other foreigners in Corinth who were Christians

2. Erastus, the City Treasurer

“Erastus, the city treasurer greets you,”

Frank Thielman: Erastus may well have been a person of great wealth and high social standing, moreover, and his resources of money and honor could have given him the freedom to travel with and support Paul. The Greek term translated “*treasurer*” here could refer to various offices from a low-level functionary that helped administrate the city’s financial affairs (an *arcarius*) to a wealthy and socially powerful financial officer for the city (or *quaestor*). It is hard to know why Paul would mention Erastus’s office at all if it were not something unusual, and this makes it possible that he had been a *quaestor*, “a high-ranking, honourable, and costly municipal position within the civic hierarchy.”

If so, then he may have been the Erastus named in an honorific inscription uncovered in Corinth in 1929 and dated by some scholars, although not without controversy, to the middle of the first century. The Erastus in the inscription is called an aedile, a lofty civic office reserved for the wealthy and socially powerful and to which the office of quaestor would be a natural stepping stone. If the Erastus here in Romans and the Erastus of the inscription are the same person, then he would be a Christian of unusually high social and political standing within the Pauline circle.

3. Quartus, the Significant Brother

“and Quartus, the brother.”

Frank Thielman: he was probably not Erastus’s brother, since Paul would probably have used a possessive pronoun if he had intended to indicate that the two were siblings of each other

[(:24) scribal addition

“The grace of our Lord Jesus Christ be with you all. Amen.”]

Grant Osborne: There is no **verse 24** in most modern translations because it is not found in the most trusted Greek manuscripts. It is likely a scribal addition repeating the words of **16:20**.

II. (:25-27) FINAL DOXOLOGY OF CELEBRATION

William Sanday and **Arthur Headlam:** The doxology sums up all the great ideas of the Epistle. The power of the Gospel which St. Paul was commissioned to preach; the revelation in it of the eternal purpose of God; its contents, faith; its sphere, all the nations of the earth; its author, the

one wise God, whose wisdom is thus vindicated—all these thoughts had been continually dwelt on.

A. (:25a) Celebration of Spiritual Strengthening

“Now to Him who is able to establish you”

Frank Thielman: The second theological theme that Paul emphasizes here at the letter’s conclusion is the praise that rightfully belongs to God because of his ability and willingness “*to strengthen*” (στηρίξαι) believers in their commitment to the gospel (16:25–27; cf. 1:11). The term “*strengthen*” appears elsewhere only in Paul’s Thessalonian letters. Paul wrote these letters to a persecuted and theologically confused community in need of strength and encouragement to persevere in the faith despite the suffering and doctrinal deviation that surrounded them (1 Thess 3:2, 13; 2 Thess 2:17; 3:3). The Roman Christians, too, needed strengthening and encouragement (1:11–12), and Paul probably envisioned Romans itself as a means to that end.

Thomas Schreiner: The **strengthening** envisioned is the ability to resist temptations and trials, with the result that they do not forsake and abandon the Christian faith (cf. 1 Thess. 3:2, 13; 2 Thess. 2:17; 3:3; cf. Rom. 1:11; so Käsemann 1980: 423; Dunn 1988b: 914).

John Schultz: As the word **doxology** implies, Paul brings his epistle to an end by giving glory to God. He focuses on two points as the basis for this glory: God’s power to keep and God’s wisdom prepared and provides. The apostle digresses extensively between those two points.

Ray Stedman: Have you ever had the desire **to be established**? Many people think they are established when actually they are simply stuck in the mud. Most of us think that being established means that all progress ceases. We sit down, camp there, and that is it. In that sense, there are a lot of Christians who are established. But when Paul speaks of our being established, he means **putting us on solid, stable ground**. Have you ever erected a picnic table and tried to find a place where all four legs touched the ground at the same time? You tried to establish it so that it would not rock, or become shaky, or uncertain. That is the idea that Paul has in mind in this word establish. God wants to bring you and me to a place where we are no longer rocking or shaky or unstable, but **solid** and **secure**. The idea is basically what all human beings look for -- an inner security from which you can handle all the problems of life. You become dependable, and have a true sense of worth, so that nothing gets to you, or shakes you up, or throws you off balance. This is the goal of all Christian teaching in the New Testament (and especially the goal of the letter to the Romans) that we believers might be brought to that place of security where we are not shaken by things, so that we do not lose our tempers easily, or get frustrated, angry, resentful or hostile; where we do not scream at our children, or yell at our mates, or get upset at the neighbors. Notice the resource that the apostle counts on to make that happen: *“Now to him who is able to establish you...”* It is God himself who is responsible for this. You and I are not given the final responsibility to bring this about. Isn't that encouraging?

B. (:25b) Celebration of the Gospel of Jesus Christ

“according to my gospel and the preaching of Jesus Christ,”

C. (:25c-26) Celebration of the Mystery of the Shared Faith of Jews and Gentiles

1. (:25c) Revelation of the Mystery

*“according to the revelation of the mystery
which has been kept secret for long ages past,”*

Frank Thielman: This revelation was a “*mystery*” (μυστήριον) in the sense that no one would have known it had God not graciously revealed it to his people (cf. **Rom 11:25**; cf. **Dan 2:27–30**; **Eph 1:7–10**). It was a mystery kept silent for long ages because it was revealed after many generations of God’s work among his people and when the right moment for making it known had arrived (cf. **1 Cor 2:7**; **Gal 3:23**; **4:4**; **Eph 3:5**, **9**).

2. (:26a) Manifestation of the Mystery

“but now is manifested,”

Thomas Schreiner: The word μυστήριον (*mystery*) is prominent in Paul, signifying a secret hidden from human beings. In **Rom. 11:25** the partial hardening and future salvation of Israel is a mystery that was previously hidden but is now revealed, while in **Eph. 5:32** the relationship between Christ and the church is designated a mystery. Μυστήριον (*mystery*) often relates to the inclusion of the gentiles into the community of the redeemed, for although the OT often refers to gentiles entering the people of God, it is clear only from the NT that they are equal members with the Jews in the people of God (cf. **Eph. 3:3–6**, **9**; **Col. 1:26–27**). The mystery fundamentally relates to Jesus Christ (cf. **1 Cor. 2:1**, **7**; **Eph. 1:9**; **6:19**; **Col. 2:2**; **4:3**) and the gospel in which he is proclaimed. This verse in Romans runs along the same arteries, since the mystery relates to the gospel of Jesus Christ that was previously hidden “*in former times*” (χρόνοις αἰώνιοις, *chronois aiōniois*) but has now been revealed. The revelation of the mystery (note the words ἀποκάλυψιν μυστηρίου and φανερωθέντος, *phanerōthentos*, *having been manifested*) is an eschatological event that has “*now been manifested*” (νῦν φανερωθέντος, *nyn phanerōthentos*, 16:26; so **Dunn** 1988b: 915). . .

One must accept the **tension**, acknowledging that the gospel was both **hidden** and **revealed** in the OT. In light of the fulfillment, readers are able to perceive that what was hidden in the old is now revealed through the new. What was foreshadowed in the OT is now perceived in its true significance in light of the fulfillment that has arrived. There are enough lines of direct continuity between the Testaments that the claim to see fulfillment is not arbitrary or gnostic.

3. (:26b) Anticipation of the Mystery

a. Foreshadowed in OT Prophetic Scriptures

“and by the Scriptures of the prophets,”

b. Foreordained by Divine Decree

“according to the commandment of the eternal God,”

c. Revealed to the World

“has been made known to all the nations,”

Frank Thielman: *to all the gentiles*, not in the sense that they are the revelation's only object (1:16) but in the sense that their inclusion receives special emphasis (1:5, 14, 16; 3:29; 4:16–17; 10:12–13; 11:12, 32; 15:9–12, 16, 18).

Grant Osborne: This was the **ultimate goal**, all part of God's plan from the beginning (see 1:5). Paul exclaims that it is wonderful to be alive when the mystery, God's secret—his way of saving the Gentiles—is becoming known throughout the world! All the Old Testament prophecies are coming true, and God is using Paul as his instrument to tell this Good News.

4. (:26c) Culmination of the Mystery
“leading to obedience of faith;”

Thomas Schreiner: The words “*for the obedience of faith to all the nations*” (εἰς ὑπακοὴν πίστεως εἰς πάντα τὰ ἔθνη, *eis hypakoēn pisteōs eis panta ta ethnē*) recall the words of the introduction (1:5). This phrase designates God's purpose or goal (εἰς) in making known the gospel (so Cranfield 1979: 812). Gentiles participate in the Abrahamic blessing through the obedience that flows from faith. Paul never conceived of salvation taking root among the nations without a change of behavior. The gospel that takes hold of human beings changes them so that they become servants of righteousness. Such new behavior, however, has its roots in faith, in trusting God for the strength and power to live a new life. The gospel does not summon people to exercise their own moral virtue. It calls them to put their trust in God, who raised Jesus from the dead. By trusting him they will be filled with the power to live fruitful lives.

D. (:27) **Celebration of the Glory of God for His Wisdom Manifested in Christ**
“to the only wise God,
through Jesus Christ,
be the glory forever. Amen.”

Matthew Henry: The Mediator of this praise: *Through Jesus Christ. To God only wise through Jesus Christ;* so some. It is in and through Christ that God is manifested to the world as the only wise God; for he is the wisdom of God, and the power of God. Or rather, as we read it, glory through Jesus Christ. All the glory that passes from fallen man to God, so as to be accepted of him, must go through the hands of the Lord Jesus, in whom alone it is that our persons and performances are, or can be, pleasing to God. Of his righteousness therefore we must make mention, even of his only, who, as he is the Mediator of all our prayers, so he is, and I believe will be to eternity, the Mediator of all our praises.

Michael Bird: Salvation is unveiled in God's way in God's timing and not imposed on him by external circumstances. The God who does this is “*the only wise God.*” His wisdom is his wise plan for salvation (see **Rom 11:33**). To him surely belongs “*glory forever through Jesus Christ!*” To top that off, Paul ends with “*Amen!*” (v. 27), to which we might respond with our own “*Amen indeed!*”

John Toews: Romans is about God. It begins and ends with God. The **power of God** is a specific theme which Paul introduces at crucial points in the argument of the letter (1:16, 20; 4:21; 9:17, 22; 11:23; 14:4) to address the weakness and disobedience of human beings. This power is made

known in **Paul's gospel** which reveals a mystery that fulfills an eternal order of God. The purpose of that order is the **faithful obedience of the nations to the one God through Messiah Jesus**.

* * * * *

DEVOTIONAL QUESTIONS:

- 1) Can you imagine how these individual believers must have felt to be singled out for personal greeting in this important letter from the Apostle Paul?
- 2) What type of fellowship in the gospel ministry did Paul experience in his missionary labors?
- 3) Do you feel solid and stable and established in the faith?
- 4) Does this magnificent extolling of the wisdom and power and divine plan of God cause you to respond with praise and rejoicing as you reflect on your own inclusion in salvation?

* * * * *

QUOTES FOR REFLECTION:

Thomas Schreiner: Why has God willed that gentiles experience salvation to such an extent at this stage in salvation history, and why was it largely hidden from them before? The answer is suggested in **verse 27**. The glory that belongs to God comes “*through Jesus Christ*” (διὰ Ἰησοῦ Χριστοῦ, *dia Iēsou Christou*). God did not desire that gentiles be saved on a large scale before the coming of Jesus Christ. It was his plan that gentiles experience *the obedience of faith* as a result of hearing the gospel of the Lord Jesus Christ, who lived, died, and was raised and exalted on their behalf. If a flood of gentiles were being saved before the coming of Christ, it would lessen the glory of his person and his work. Gentiles are saved through a conscious knowledge of Jesus Christ and his work on their behalf in accord with the Pauline gospel (note “*my gospel*” in **v. 25**). Paul is awestruck because God has given him the privilege of preaching this gospel, which is the **capstone** of God’s revelation and the **fulfillment** of all that is adumbrated in the OT, whereby God’s plan to bring the greatest honor to himself is realized. In other words, the unfolding of human history is not arbitrary. God concealed the truth in the past and has revealed it now in his wisdom (μόνῳ σοφῷ θεῷ, *monō sophō theō*, *to the only wise God*). As he reflects on the plan of salvation history, Paul is overwhelmed, as he was in **11:33–36**, with God’s **wisdom** and **glory**. His glory reaches its apex through the work and ministry of Jesus Christ, and the gentiles show that God is glorious by entrusting their lives to him. The most magnificent thing of all is that the glory will never end.

R. Kent Hughes: God can establish us and make us strong and steadfast in any circumstance. When he so chooses, he demonstrates this in the physical realm as well. Years ago when **Ira Sankey** was at the height of his ministry and traveling on a steamer in the Delaware River, he was recognized by some of the people onboard. They had seen his picture in the newspaper and

knew he was associated with evangelist D. L. Moody. When he was asked to sing one of his own compositions, Sankey said he preferred the hymn by William Bradbury, "*Savior, Like a Shepherd Lead Us*." He suggested that everyone should join in the singing. One of the stanzas begins, "We are Thine, do Thou befriend us; be the guardian of our way." When he finished, a man stepped out of the shadows and inquired, "Were you in the army, Mr. Sankey?" "Yes, I joined up in 1860." "Did you ever do guard duty at night in Maryland, about 1862?" "Yes, I did." "Well, I was in the Confederate Army," said the stranger, "and I saw you one night at Sharpsburg. You were wearing your blue uniform, and I had you in my gun sight as you stood there in the light of the full moon. Then just as I was about to pull the trigger, you began to sing." Sankey was astounded as he recalled the incident. "It was the same hymn you sang tonight," continued the man. "I couldn't shoot you." There is no doubt about it—God can make us stand firm under his protection!

John MacArthur: There is a remarkable relationship between the last three verses of Romans and the first eleven. In **Romans 16:25** Paul speaks of Him who is able to establish you, and in **Romans 1:11** he talks of his readers being established. He speaks of my gospel, and in **Romans 1:1** of "*the gospel of God*." He speaks of the mystery of God which has been kept secret for long ages past, and in **Romans 1:2** of the gospel "*which He promised beforehand*." He mentions the preaching of Jesus Christ, and in **Romans 1:3** the gospel concerning God's Son. He speaks of the Scriptures of the prophets, just as he does in **Romans 1:2**. He speaks of the gospel being made known to all the nations, leading to obedience of faith, and in **Romans 1:5** of bringing "*about the obedience of faith among all the Gentiles*."

Ray Stedman: The **heart of the mystery** is given to us in the opening chapter of Colossians. Here is one of the clearest statements on it (**Col 1:24, 25, 26, 27**) "... *this mystery among the Gentiles which is Christ in you the hope of glory*"). There is the mystery. All that God is, wrapped up in a Person and given to you and to me -- the only hope we have of ever discovering the glory that God intended for us as human beings: Christ in you, the hope of glory... Jesus himself is the mystery (see **1 Tim 3:16**). By means of the virgin birth of Jesus, by means of his holy, sinless life, by means of his substitutionary death upon a violent and cruel cross, by means of his startling break-out from the prison of death, and by means of the gift of the Holy Spirit on the day of Pentecost, God has given Jesus -- all that he is and all that he has -- to you and to me. This enables us to do two things: To deny our natural abilities and strengths, and to rely wholly on Jesus' ability & strength -- & thus to live our lives today as though Jesus Himself was living them. That is the mystery. That is the radical, powerful secret of authentic Christianity: Christ in you, the hope of glory. Do you know that mystery? Do you know it, not only in your mind, but do you live it? It is the knowledge of it and the living of it that turns Christianity into an exciting adventure. It may be demanding, it may even be scary, but I can guarantee you one thing: It will never be boring, because the mystery is at work. If you are filled with the secret, the indwelling Christ, it does not make any difference if you are a Jew or a Gentile. All the divisions of class and sex and national origin are eliminated by that secret. It does not make any difference whether you are rich or poor, slave or free, all are one in Christ Jesus by that mystery. And whenever a Christian lives on that basis, really trusting the fact that God is in him through Jesus Christ to be his wisdom, his power, his strength; when he attempts things only on the basis of expecting God to fulfill that promise, and moves out to do things by His grace, he finds himself **established**. If you want a place of **security**, it is not going to come by your reckoning on what you can do for

God. That will never work. It is going to depend on how much you believe God is ready to do something through you. That is the radical promise... What a change happens when people really capture this and begin to operate on it... by the death of Jesus, God cut off all the natural abilities and strengths that we have, and rendered them worthless. The New Testament teaches us that the flesh cannot please God... Jesus himself, the bread that came down from heaven, is available to us. His strength, His power, operating through the channel of our gifts, can accomplish what we could never do by ourselves. God at work within us; that is the mystery... in every situation throughout the week, every moment of pressure and every demand upon us are simply opportunities to respond by realizing again the validity of the mystery. **Jew & Gentile one in Christ & Christ in us the hope of glory.** What a note to end the book of Romans on!

Steven Cole: The Goal of the Gospel: The Glory of God

The goal of the gospel is that we would glorify the only wise God through Jesus Christ as we live in obedient faith and proclaim Him to the nations.

1. To glorify God, we need to be established according to the gospel and live in obedient faith.

A. GOD HAS THE POWER TO ESTABLISH US ACCORDING TO THE GOSPEL.

B. GOD ESTABLISHES US THROUGH THE PREACHING OF JESUS CHRIST.

C. GOD ESTABLISHES US ACCORDING TO THE REVELATION OF THE MYSTERY THAT HAS BEEN KEPT SECRET FOR LONG AGES PAST, BUT NOW IS MANIFESTED.

D. GOD ESTABLISHES US BY THE SCRIPTURES OF THE PROPHETS.

E. WE KNOW THAT GOD HAS ESTABLISHED US IN THE GOSPEL WHEN WE BELIEVE IT AND LIVE IN OBEDIENCE TO JESUS CHRIST.

2. To glorify God, we must proclaim His gospel to the nations.

“according to the commandment of the eternal God, has been made known to all the nations...”

God is glorified when people from every tongue, tribe, and nation believe in and obey Jesus Christ. We all need to labor to that end.

3. The goal of the gospel is that we would glorify the only wise God through Jesus Christ forever.

Douglas Moo: The wonderful doxology in **16:25–27** is an appropriate way to end a letter that so beautifully sets forth the truth of the gospel. All theology has its ultimate goal in the glory of God, and any true theology will always lead to this end. Theology, the “study of God,” is not an intellectual pastime. Nor is it only for the good of the church. Its ultimate purpose is to enable God’s people to glorify him more effectively and more passionately because they have learned

more about him. We noted above how Paul weaves into this doxology so many of the motifs of the letter. It is as if he himself is led to burst out in spontaneous praise to God as he reflects on the marvelous truths he has taught in the letter. May our “bottom line” also be *sola dei gloria*—“to God alone be the glory.”

Leedy Greek NT Diagrams;

Rom 16:21

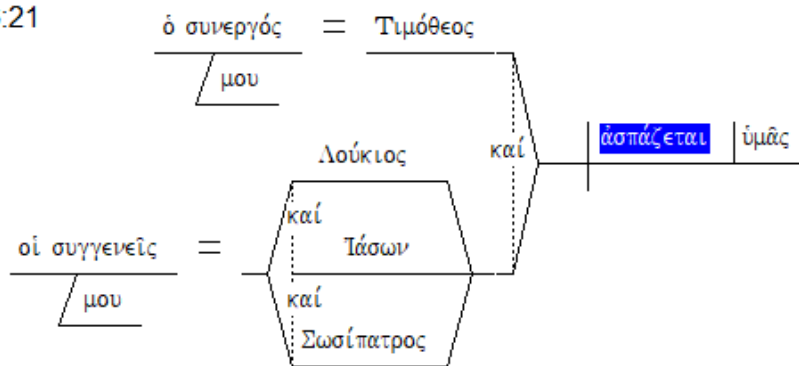

Rom 16:22

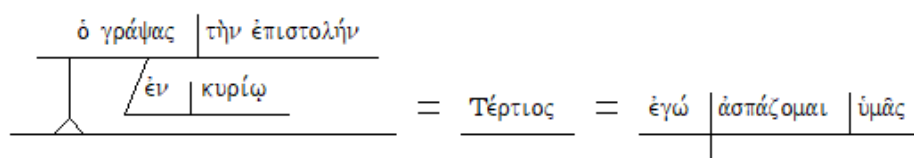

Rom 16:23

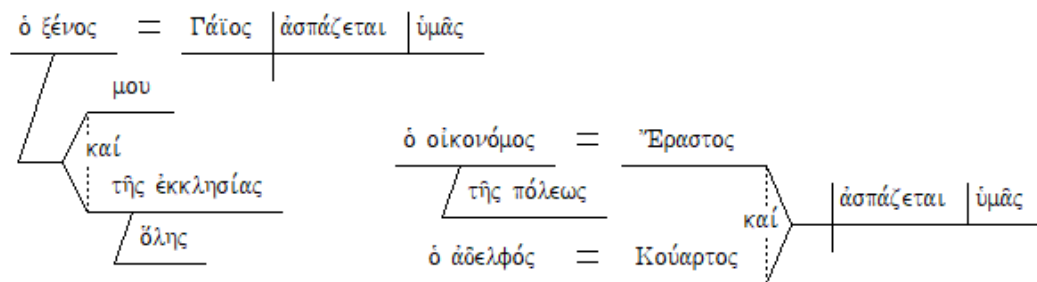

Rom 16:24 [omitted from NA27]

Rom 16:25-27

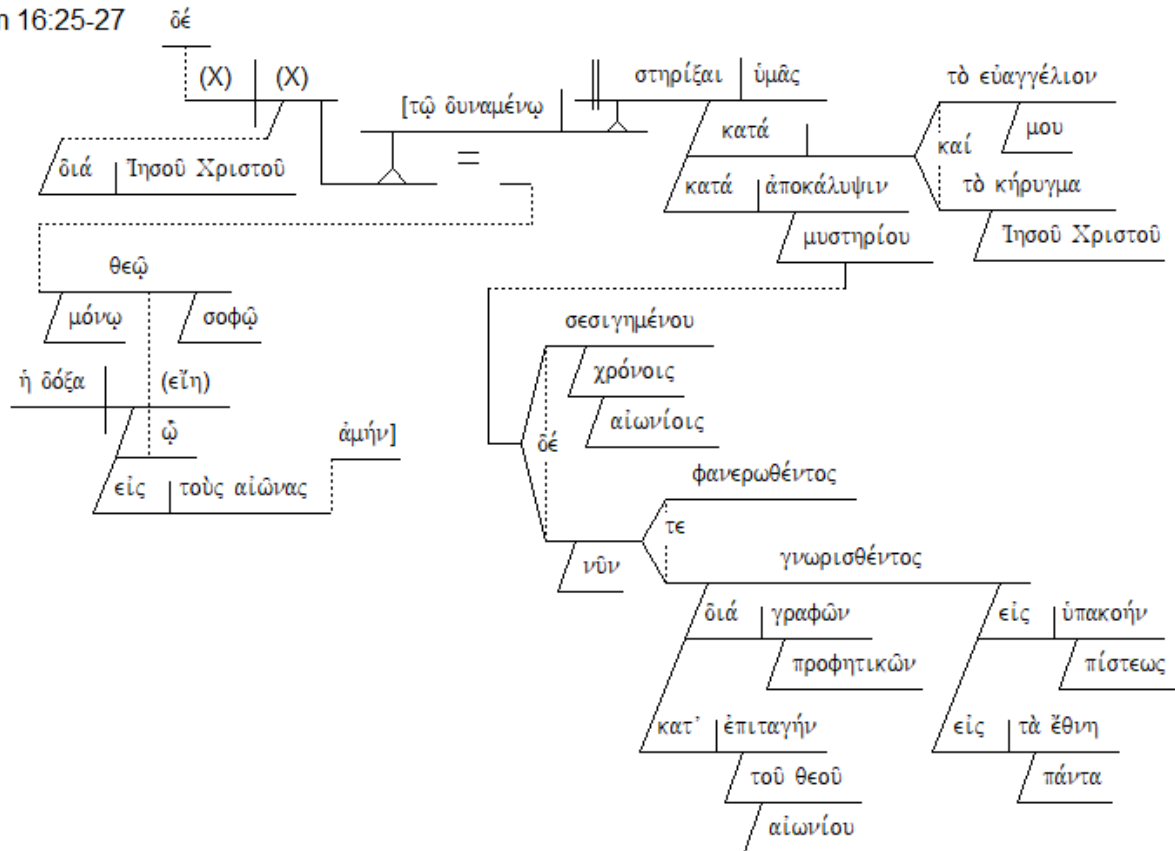

Frank Thielman:

- 21a Assertion **Timothy my coworker greets you, and also**
- b List **Lucius,**
- c **Jason, and**
- d **Sosipater,**
- e Apposition **my compatriots.**

- 22 Assertion **I, Tertius, the one who has written this letter in the Lord, greet you.**

- 23a Assertion **Gaius, host to me and to the whole church, greets you.**

- b Assertion **Erastus, the treasurer of the city greets you, and Quartus, the brother.**

25a Exclamation
b Reference

Now **to the one who is able to strengthen you**

according to my gospel and
the preaching of Jesus Christ,

c Reference

according to the revelation of the mystery

d Explanation

kept silent for long ages ... but

26a Contrast (to 25d)

now disclosed, and
made known

b Association

through the prophetic writings

c Reference

according to the command of the eternal God

d Purpose

for the obedience of faith

e Place

to all the gentiles

27a Restatement (of 25a)

To the only wise God through Jesus Christ ...

b Restatement (of 27a)

to whom be the glory forever.

c Conclusion

Amen.

BIBLIOGRAPHY

BOOKS:

Baxter, J. Sidlow. *Explore the Book*. Grand Rapids, MI: Zondervan, 1960.

Best, Ernest. *The Cambridge Bible Commentary on the New English Bible – The Letter of Paul to the Romans*. London: Cambridge University Press, 1967.

Bird, Michael F. *The Story of God Bible Commentary – Romans*. Grand Rapids, MI: Zondervan, 2016.

Bruce, F. F. *Tyndale New Testament Commentaries – The Epistle of Paul to the Romans*. Grand Rapids, MI: Wm. B. Eerdmans Publishing Company, 1963.

Denney, James. *The Expositor's Greek Testament – “St. Paul's Epistle to the Romans.”* Grand Rapids, MI: Wm. B. Eerdmans Publishing Company, 1976.

Dunn, James D. G. *Word Biblical Commentary – Romans 1-8*. Grand Rapids, MI: Zondervan, 2018.

Dunn, James D. G. *Word Biblical Commentary – Romans 9-16*. Grand Rapids, MI: Zondervan, 2018.

Gorman, Michael J. *Romans – A Theological & Pastoral Commentary*. Grand Rapids, MI: William B. Eerdmans Publishing Company, 2022.

Gundry, Robert H. *Commentary on Romans*. Grand Rapids, MI: Baker Academic, 2011.

Harrison, Everett F. *The Expositor's Bible Commentary with the New International Version -- Romans through Galatians, Volume 10*. Grand Rapids, MI: Zondervan, 1976.

Harvey, John D. *Exegetical Guide to the Greek New Testament: Romans*. Nashville, TN: B&H Academic, 2017.

Hendriksen, William. *New Testament Commentary – Romans Chapters 1-8*. Grand Rapids, MI: Baker Book House, 1980.

Hendriksen, William. *New Testament Commentary – Romans Chapters 9-16*. Grand Rapids, MI: Baker Book House, 1981.

Hodge, Charles. *Commentary on the Epistle to the Romans*. Grand Rapids, MI: Wm. B. Eerdmans Publishing Company, 1947.

Henry, Matthew. *Matthew Henry's Commentary on the Whole Bible*. Wilmington, DE: Sovereign Grace Publishers, 1972.

Hughes, R. Kent. *Preaching the Word – Romans – Righteousness from Heaven*. Wheaton, IL: Crossway, 2013.

Jensen, Irving L. *Romans – A Self-Study Guide*. Chicago, IL: Moody Press, 1969.

Jeremiah, David. *Jeremiah Bible Study Series – Romans – the Gospel of Grace*. Nashville, TN: Thomas Nelson – Peachtree Publishing Service, 2020.

Keller, Tim. *Romans 1-7 For You*. The Good Book Company, 2014.

Keller, Tim. *Romans 8-16 For You*. The Good Book Company, 2015.

MacArthur, John. *The MacArthur Study Bible*. Nelson Bibles, 2006.

McClain, Alva J. *Romans: The Gospel of God's Grace – Lectures* edited by Herman A. Hoyt. Chicago, IL: Moody Press, 1973.

Merida, Tony. *Christ-Centered Exposition – Exalting Jesus in Romans*. Nashville, TN: Holman, 2021.

Mickelsen, A. Berkeley. *The Wycliffe Bible Commentary -- "The Epistle to the Romans."* Chicago, IL: Moody Press, 1962.

Moo, Douglas. *The NIV Application Commentary – Romans*. Grand Rapids, MI: Zondervan, 2009.

Murray, John. *The Epistle to the Romans*. Grand Rapids, MI: William B. Eerdmans Publishing Company, 2018.

Osborne, Grant R. *Life Application Bible Commentary – Romans*. Carol Stream, IL: Tyndale House Publishers, Inc., 2021.

Schreiner, Thomas R. *Baker Exegetical Commentary on the New Testament -- Romans – Second Edition*. Grand Rapids, MI: Baker Publishing Group, 2018.

Stedman, Ray C. *Adventuring Through the Bible*. Grand Rapids, MI: Discovery House Publishers, 1997.

Stifler, James A. *The Epistle to the Romans*. Chicago, IL: Moody Press, 1960.

Tackett, Steven L. *Romans: Dispensationally Considered – A Grace Expositional Commentary*. Meadville, PA: Christian Faith Publishing, Inc., 2022.

Thielman, Frank. *Exegetical Commentary on the New Testament – Romans*. Grand Rapids, MI: Zondervan, 2018.

Toews, John E. *Believers Church Bible Commentary – Romans*. Scottsdale, PA: Herald Press, 2004.

Wiersbe, Warren W. *The Bible Exposition Commentary NT – Volum 1 – Matthew – Galatians – “Romans.”* Colorado Springs, CO: Cook Communications Ministries, 1989.

Witmer, John A. *The Bible Knowledge Commentary – “Romans.”* Colorado Springs, CO: Cook Communications Ministries, 1983.

ONLINE RESOURCES:

(mainly https://www.preceptaustin.org/romans_commentaries or www.sermoncentral.com or www.sermonaudio.com)

Barnett, Brent.

<http://www.relevantbibleteaching.com/home/140001239/140001239/romans.pdf>

Biblical Illustrator: https://www.preceptaustin.org/romans_commentaries

Carr, Alan. https://www.preceptaustin.org/romans_commentaries

Cole, Steven J. <https://bible.org/series/romans-0>

Constable, Thomas. <https://planobiblechapel.org/tcon/notes/pdf/romans.pdf>

Deffinbaugh, Bob. <https://bible.org/series/reasoning-through-romans>

Guzik, David. <https://enduringword.com/bible-commentary/romans-1/>

Halverson, Richard. https://www.preceptaustin.org/romans_commentaries

Herrick, Greg. <https://bible.org/series/romans-gospel-gods-righteousness>

Hurt, Bruce. https://www.preceptaustin.org/romans_commentaries

Johnson, S. Lewis. <https://sljinstitute.net/category/pauls-epistles/romans/>

Larson, Steve. https://www.preceptaustin.org/romans_commentaries

MacArthur: John.

Introduction: https://www.blueletterbible.org/Comm/macarthur_john/bible-introductions/romans-intro.cfm

Commentary: <https://www.gty.org/library/resources/bible-series-library/scripture/1?book=45>

Malick, David.

Introduction: <https://bible.org/article/introduction-book-romans>

Argument: <https://bible.org/article/argument-book-romans>

Piper, John. <https://www.desiringgod.org/series/romans-the-greatest-letter-ever-written/messages>

Rugh, Gil.

<https://www.sermonaudio.com/search.asp?t=t&keyword=Romans&BibleOnly=true&subcatid=speaker&subsetitem=Gil+Rugh>

Schultz, John. https://www.bible-commentaries.com/source/johnschultz/BC_Romans.pdf

StudyLight Commentaries. <https://www.studylight.org/commentaries/eng/tbi/romans-.html>

Swindoll, Chuck. <https://insight.org/resources/bible/the-pauline-epistles/romans>

Thompson, David.

<https://www.sermonaudio.com/search.asp?t=t&keyword=Romans&BibleOnly=true&subcatid=speaker&subsetitem=David+E%2E+Thompson>

TruthAccordingtoScripture.

<https://www.truthaccordingtoscripture.com/commentaries/index.php>

Utley, Bob. <https://bible.org/seriespage/romans-1-0>

Van Parunak: [https://www.cyber-](https://www.cyber-chapel.org/sermons/romans/notes/Romans1_11Outline.pdf)

[chapel.org/sermons/romans/notes/Romans1_11Outline.pdf](https://www.cyber-chapel.org/sermons/romans/notes/Romans1_11Outline.pdf)

Wallace, Daniel B. <https://bible.org/seriespage/romans-introduction-argument-and-outline>